

Robocop

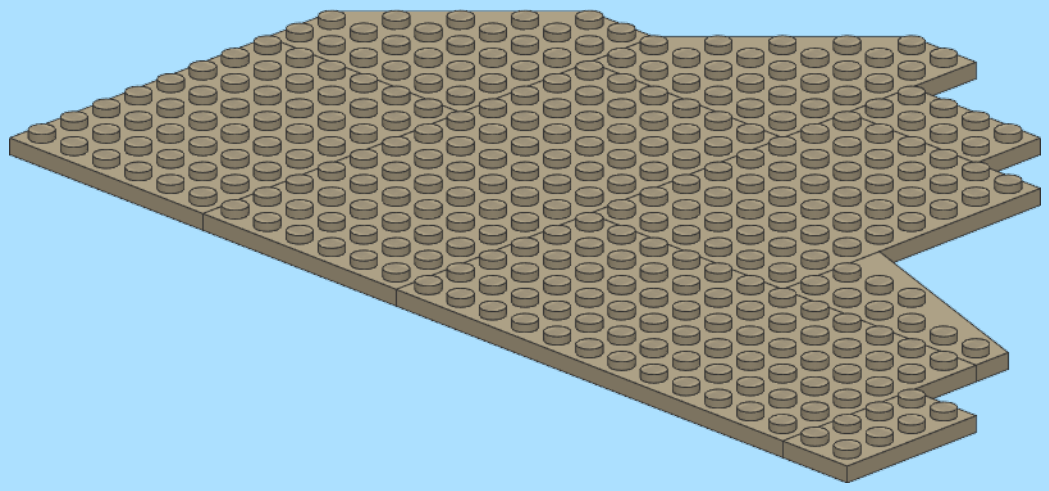

Designed By
Marin Stipkovic

INSTRUCTION BY
KNUD ALBRECHTSEN
www.snakebyte.dk/lego

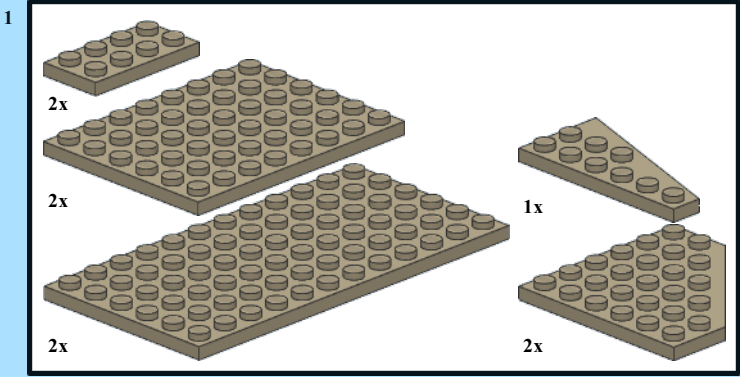

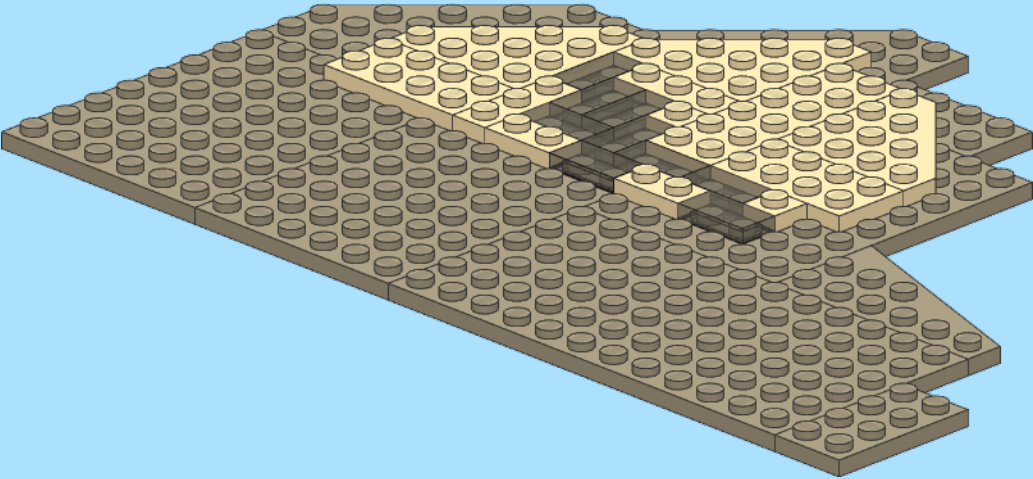
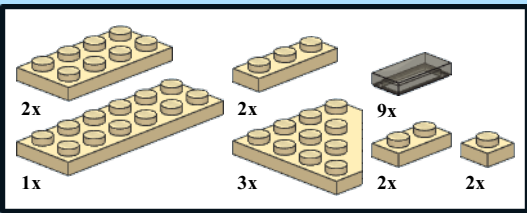

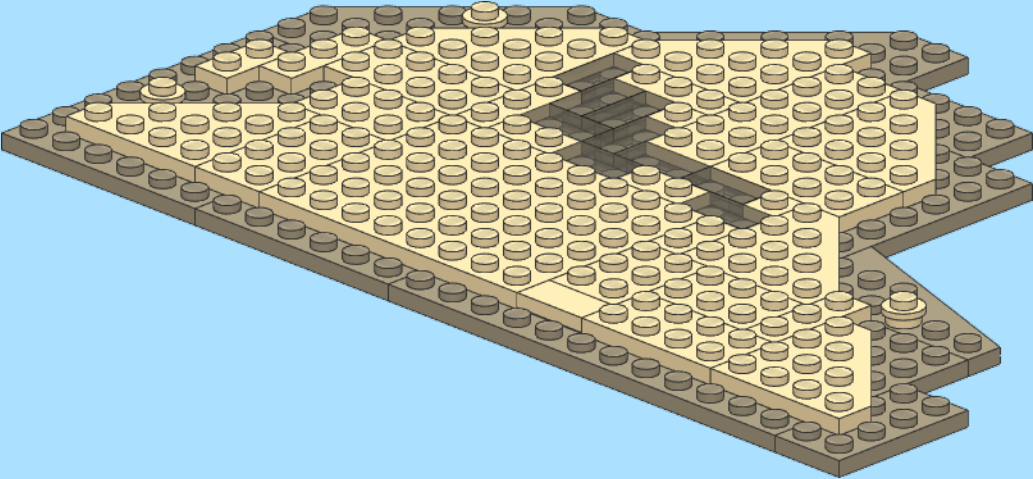
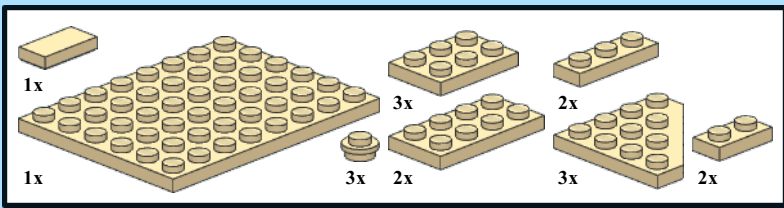

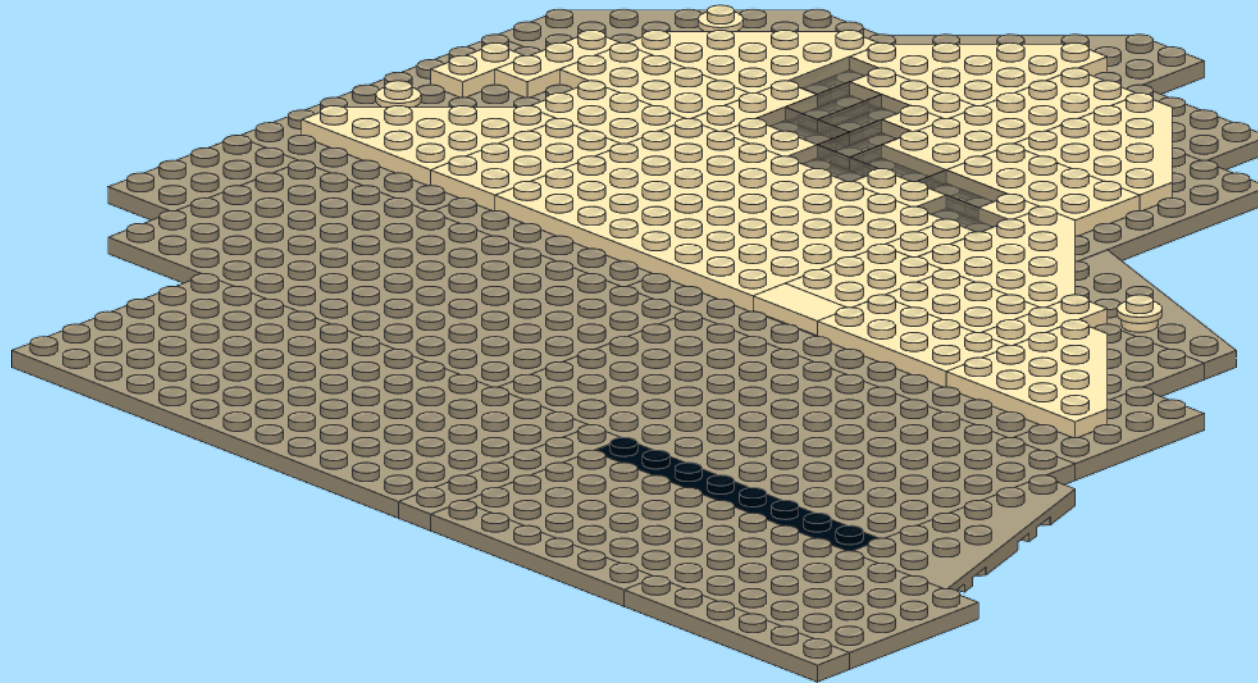
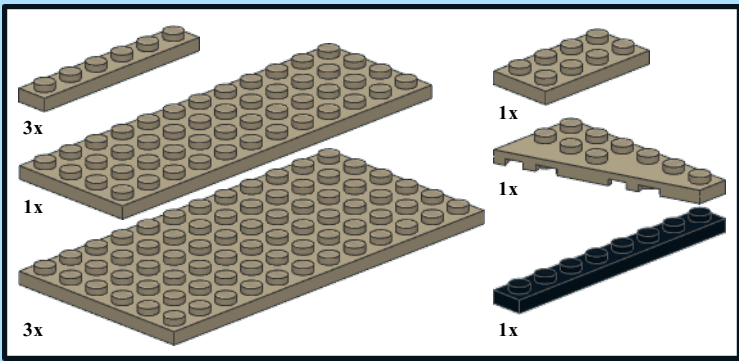

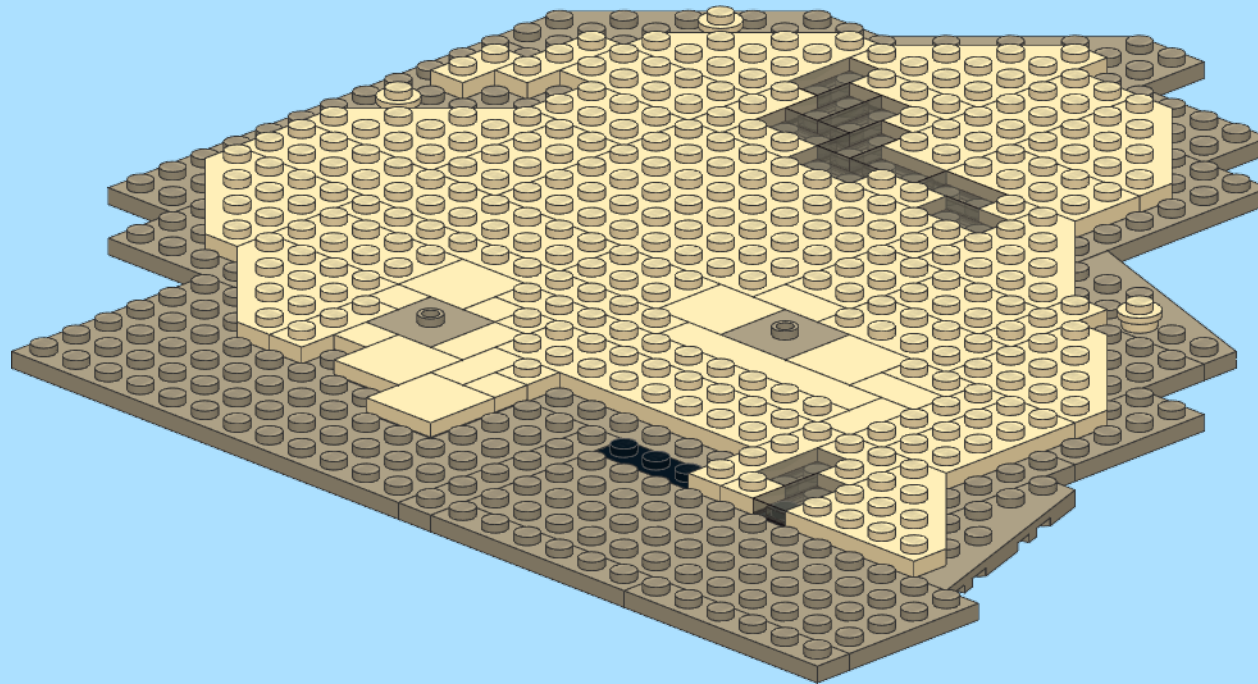
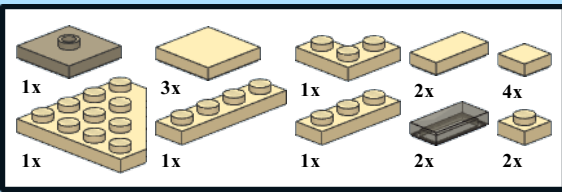

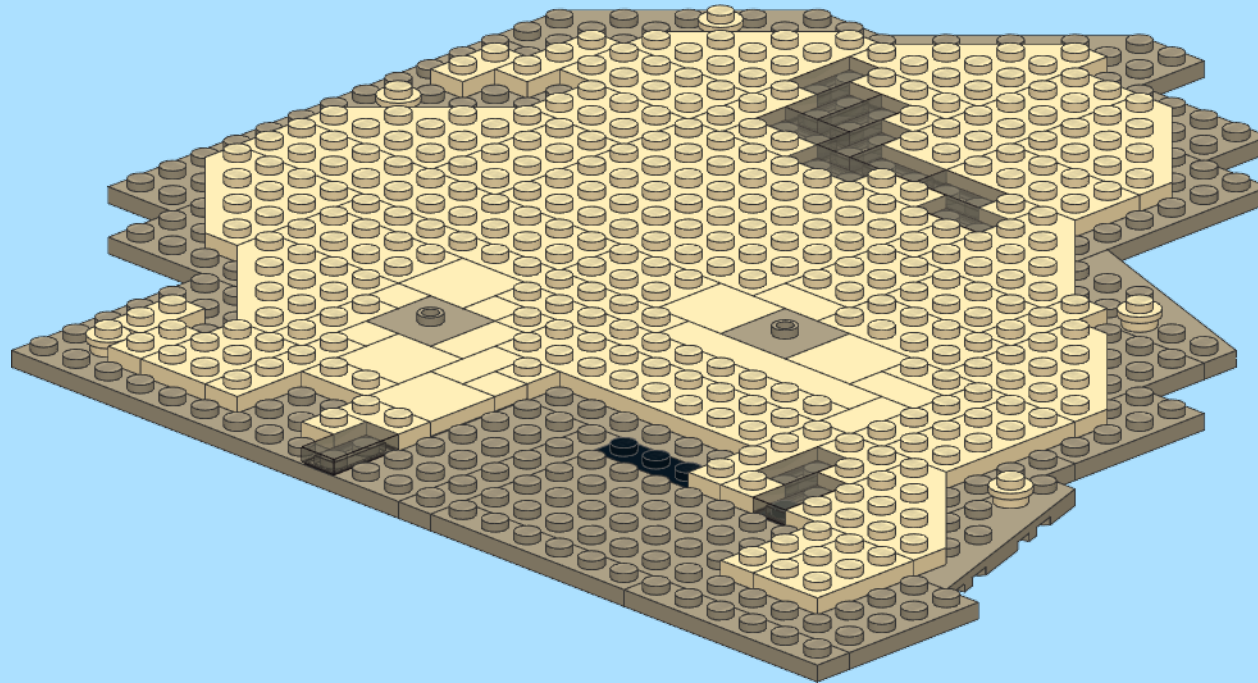
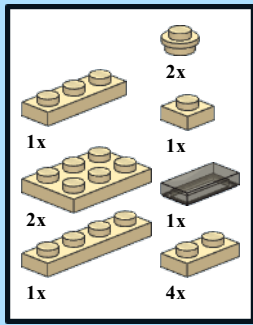

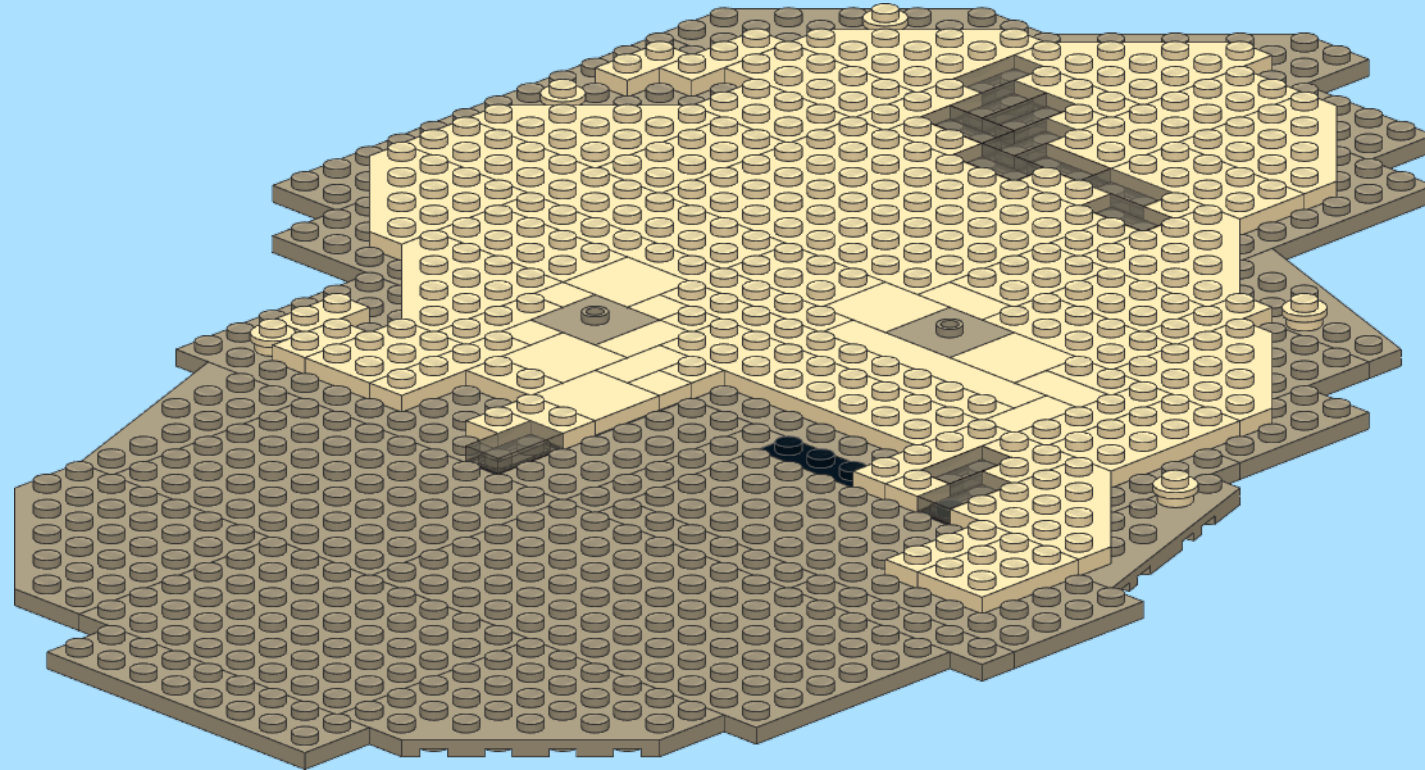
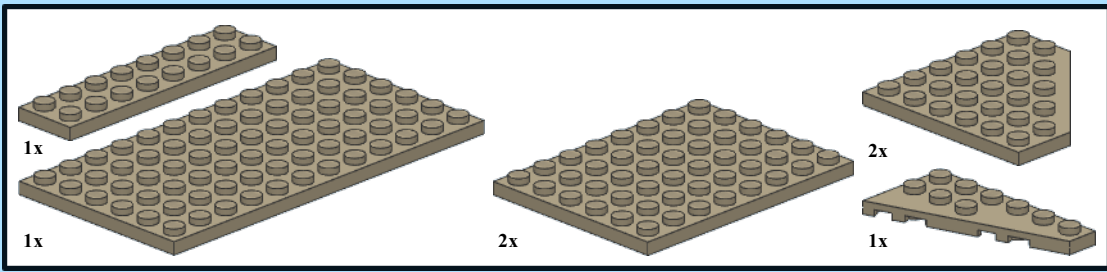

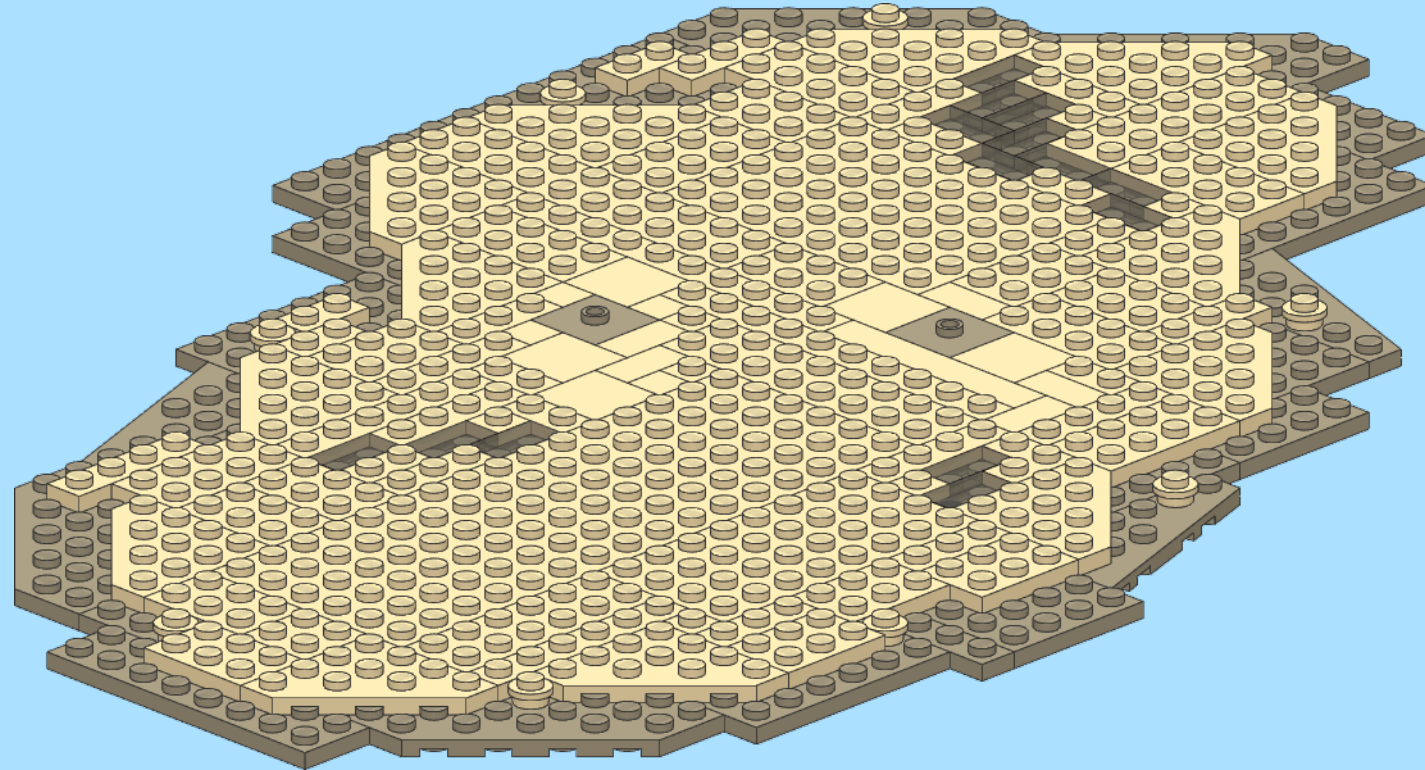
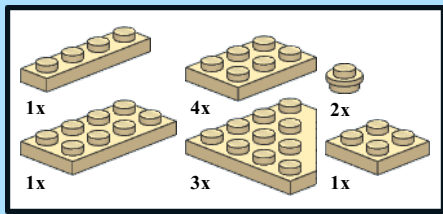

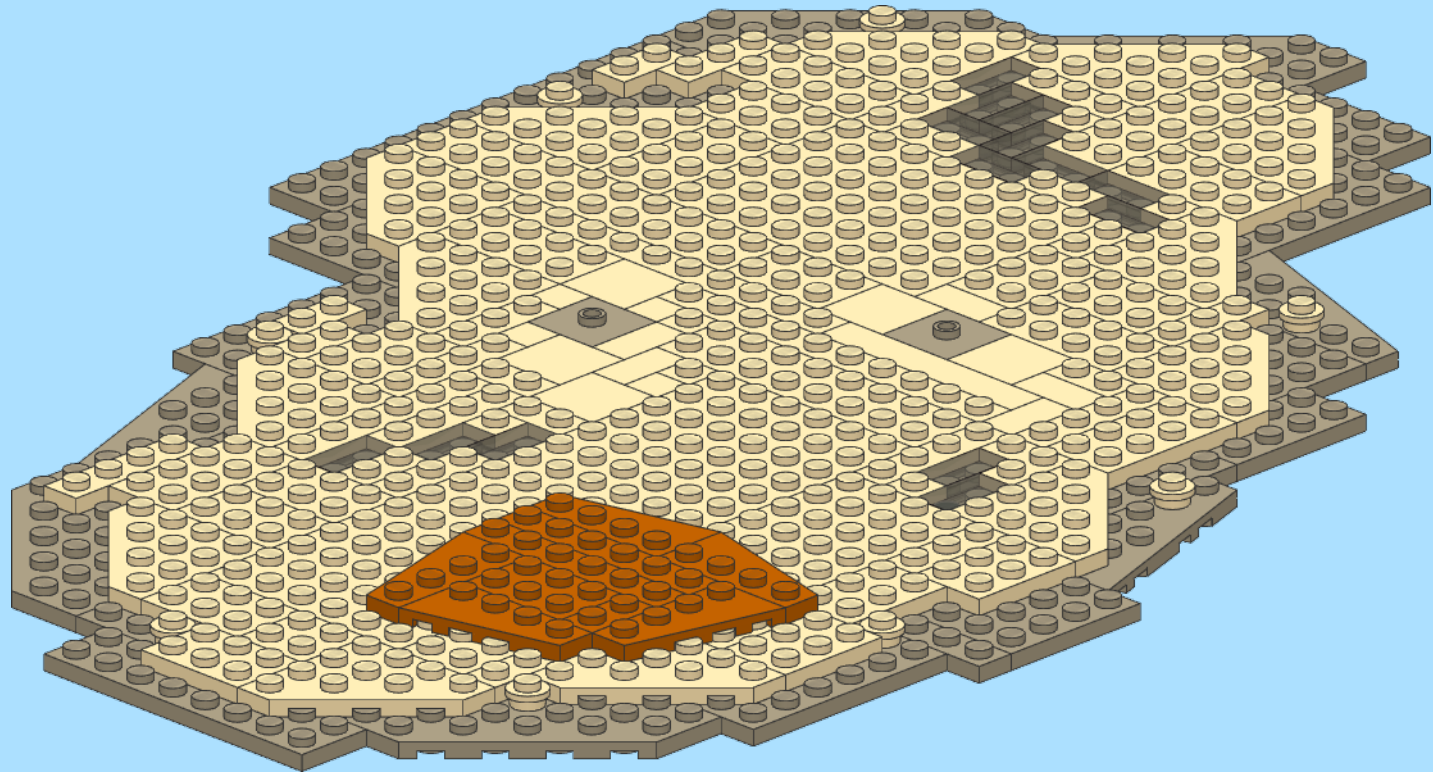
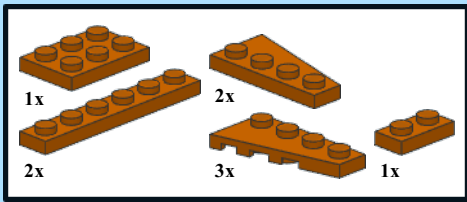

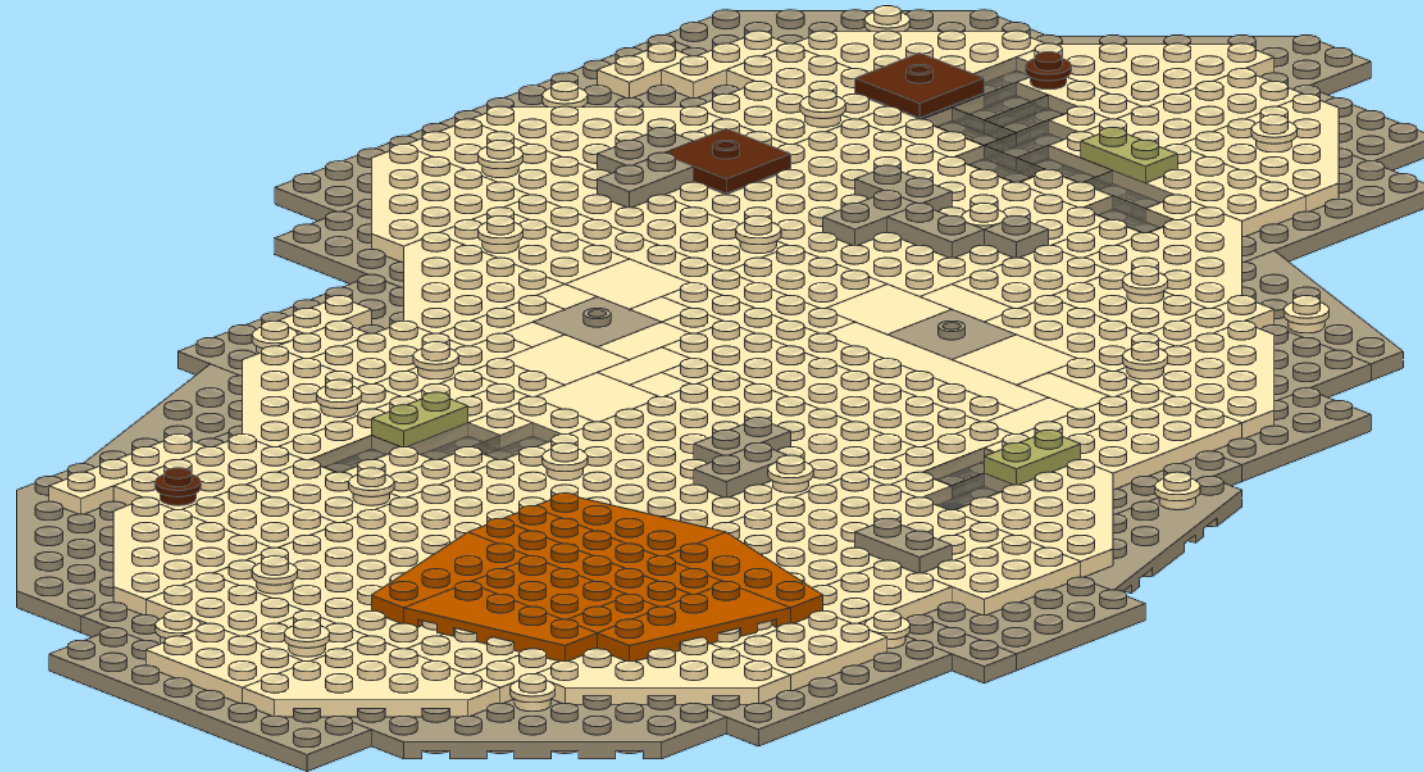



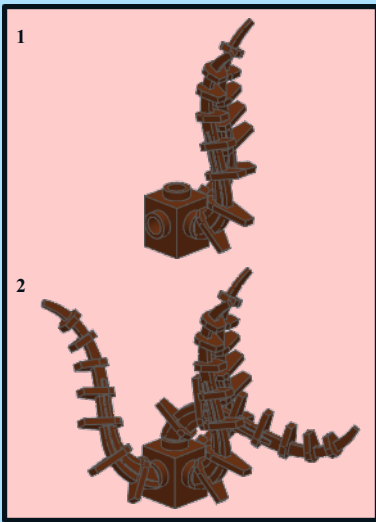
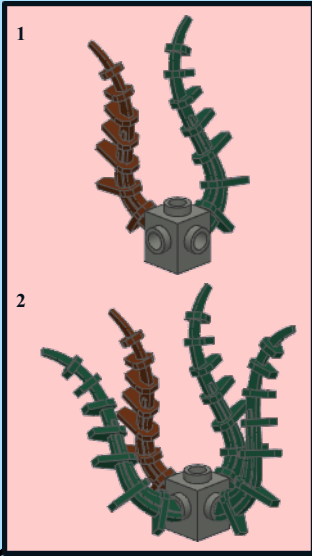
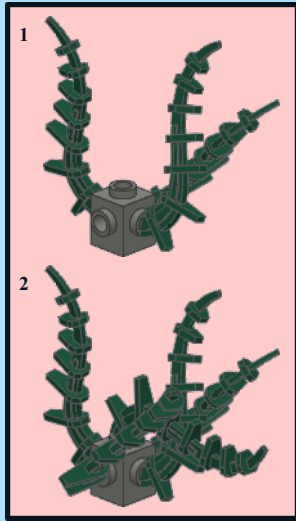
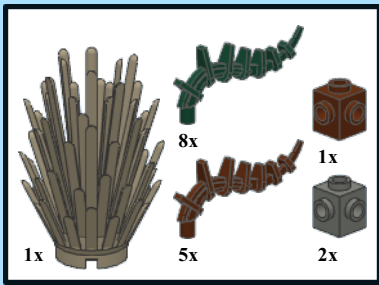

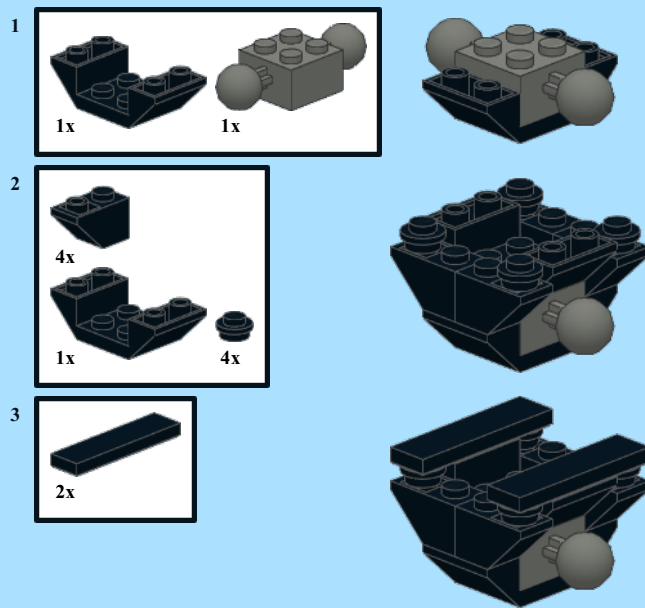

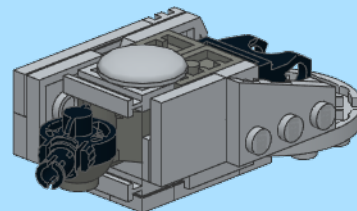
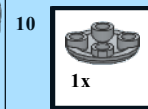
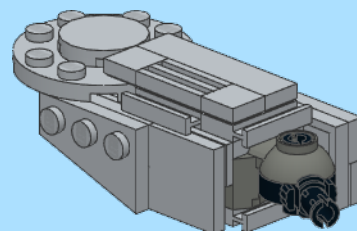
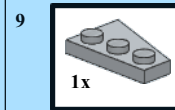
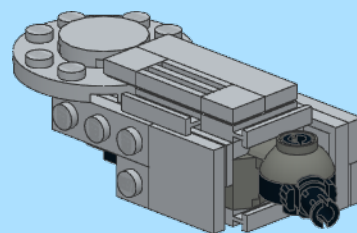
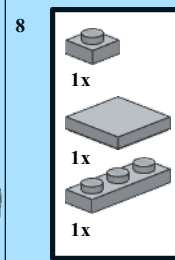
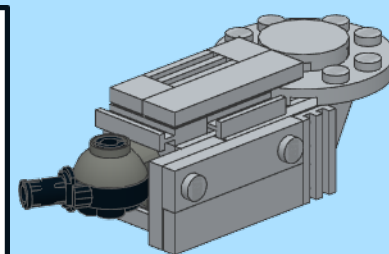
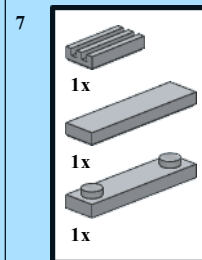
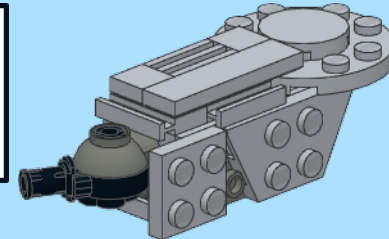
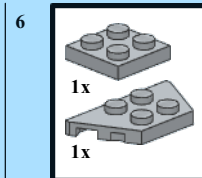
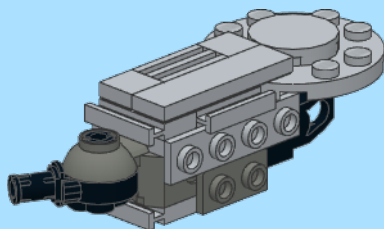
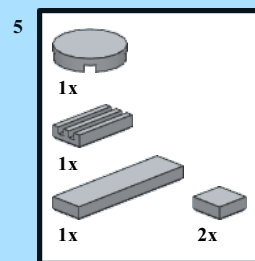
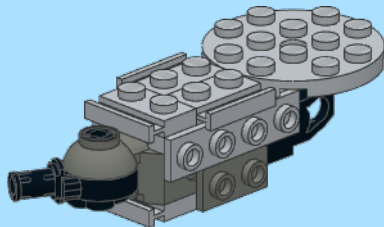
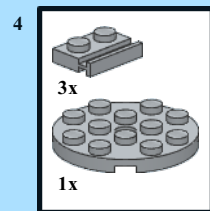
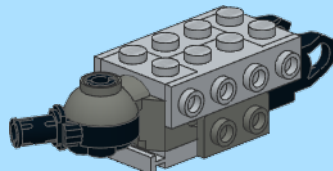
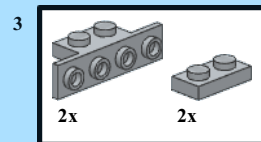
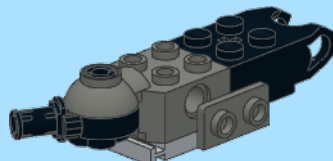
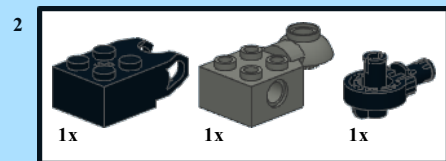
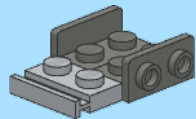
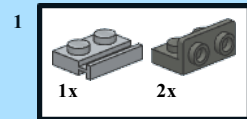

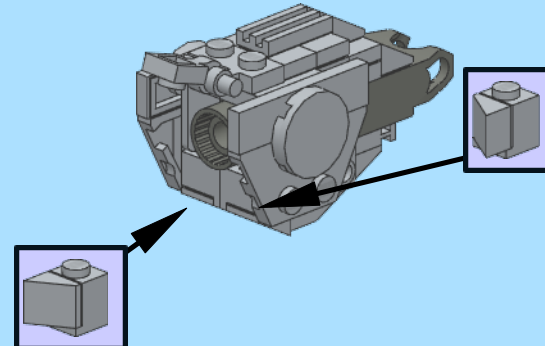
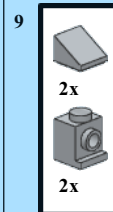
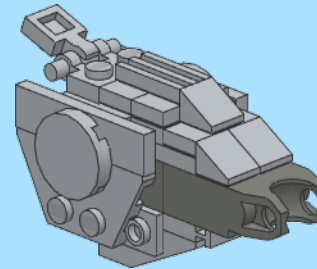
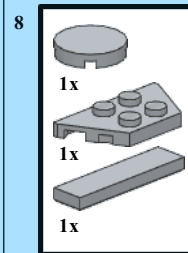
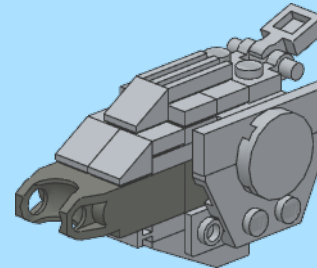
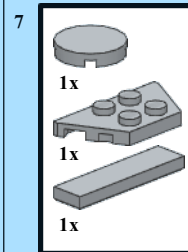
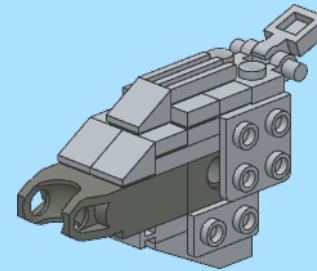
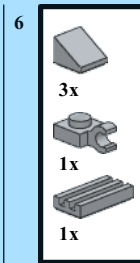
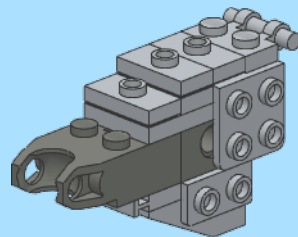
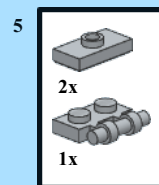
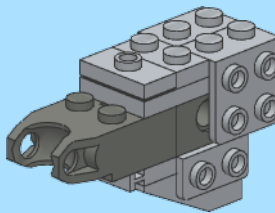
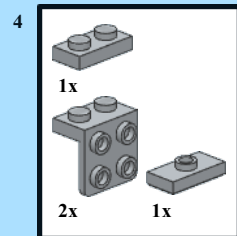
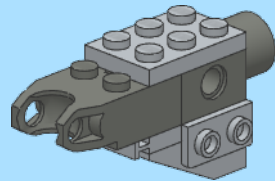
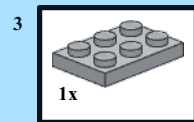
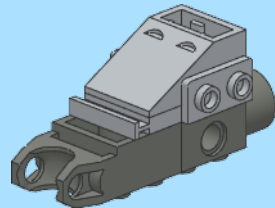
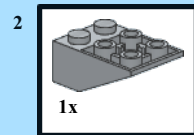
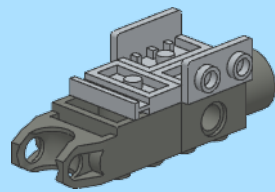
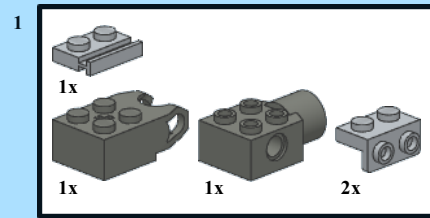

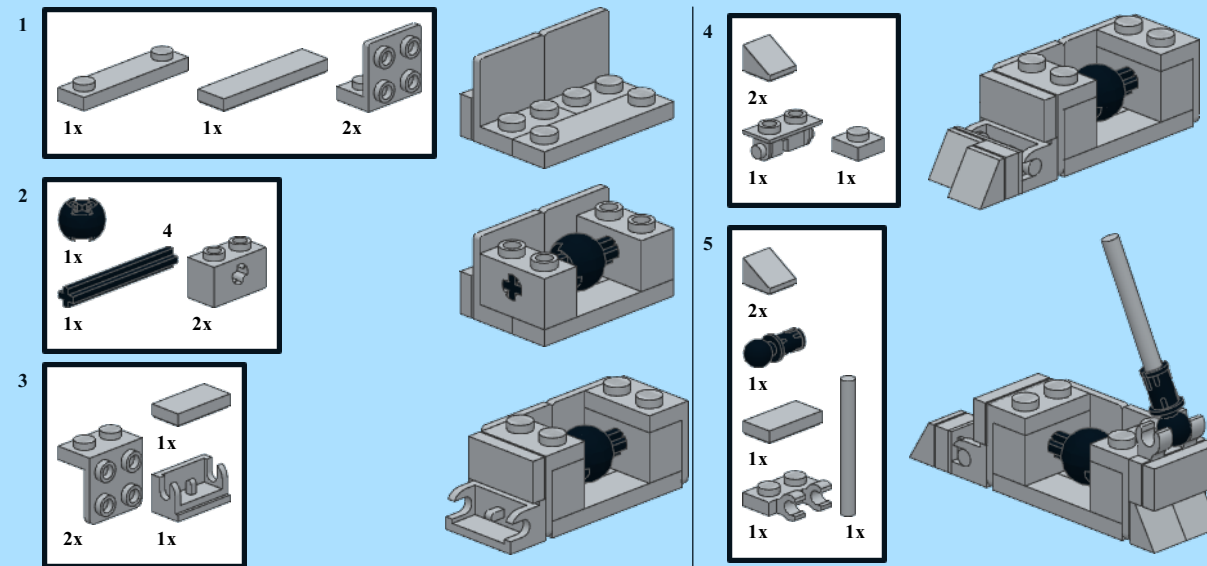

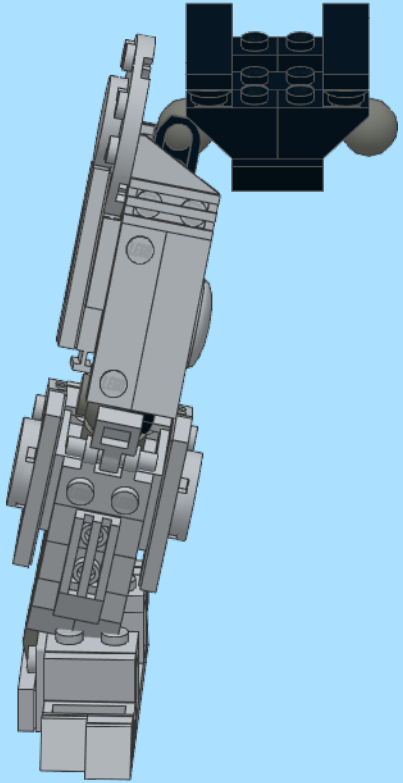

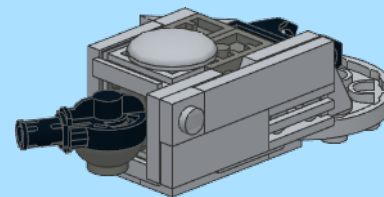
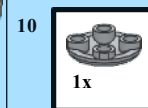
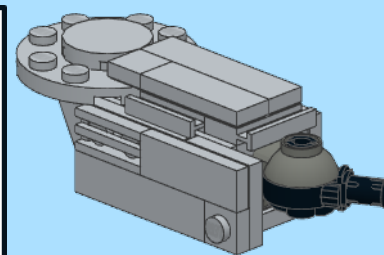
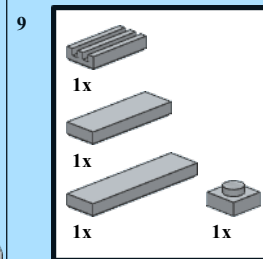
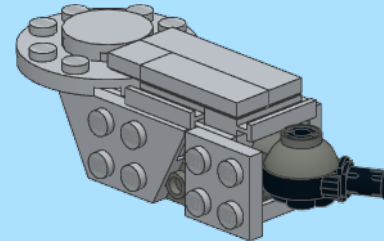
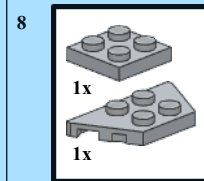
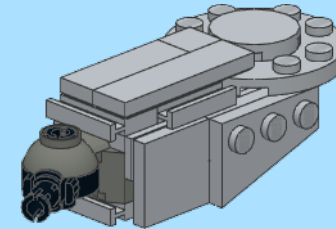
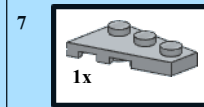
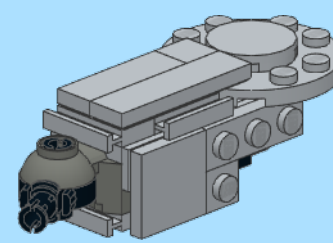
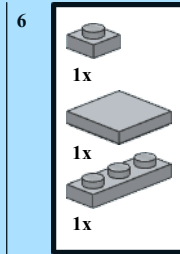
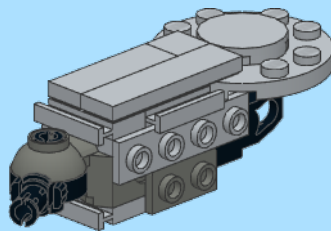
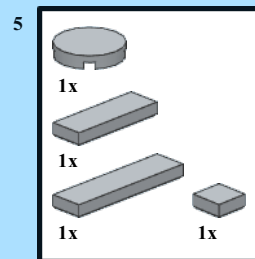
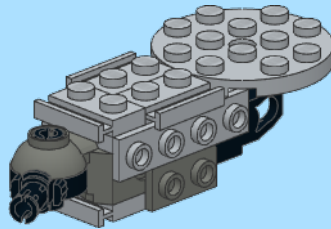
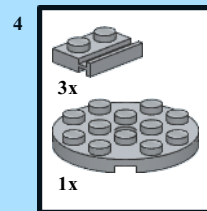
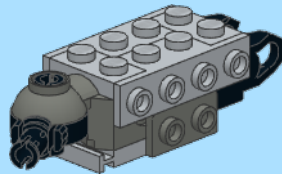
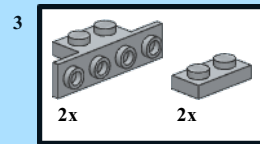
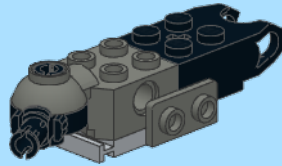
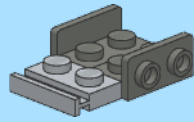
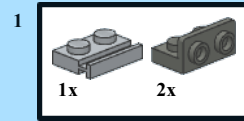

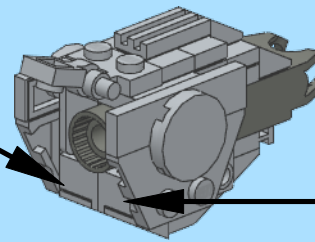
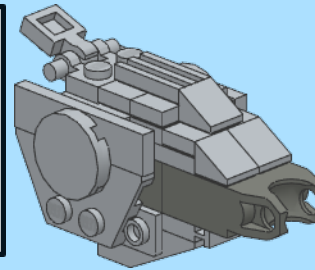
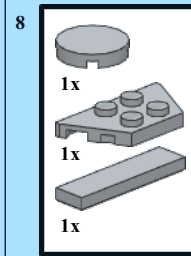
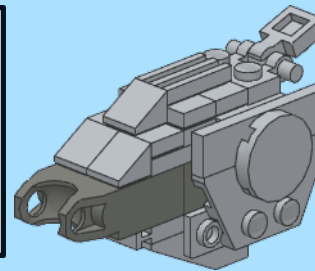
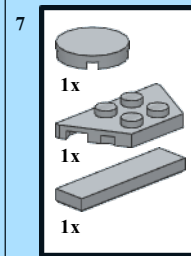
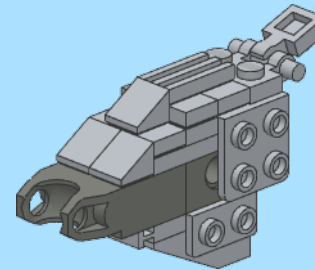
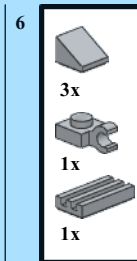
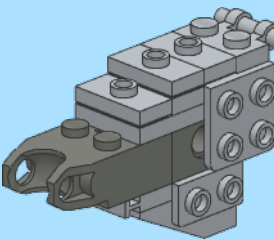
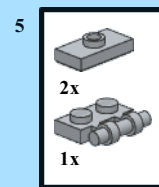
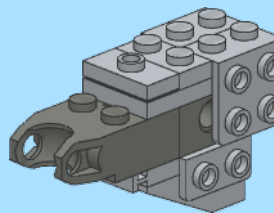
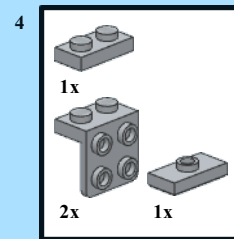
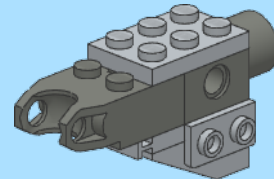
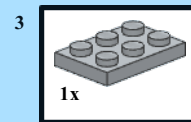
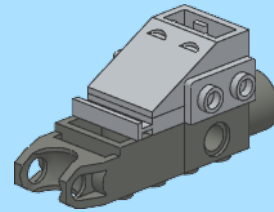
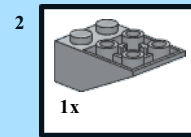
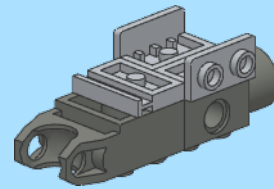
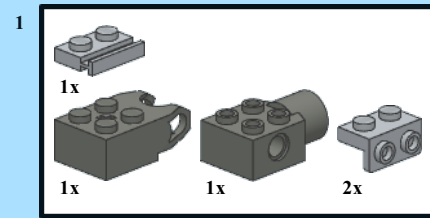

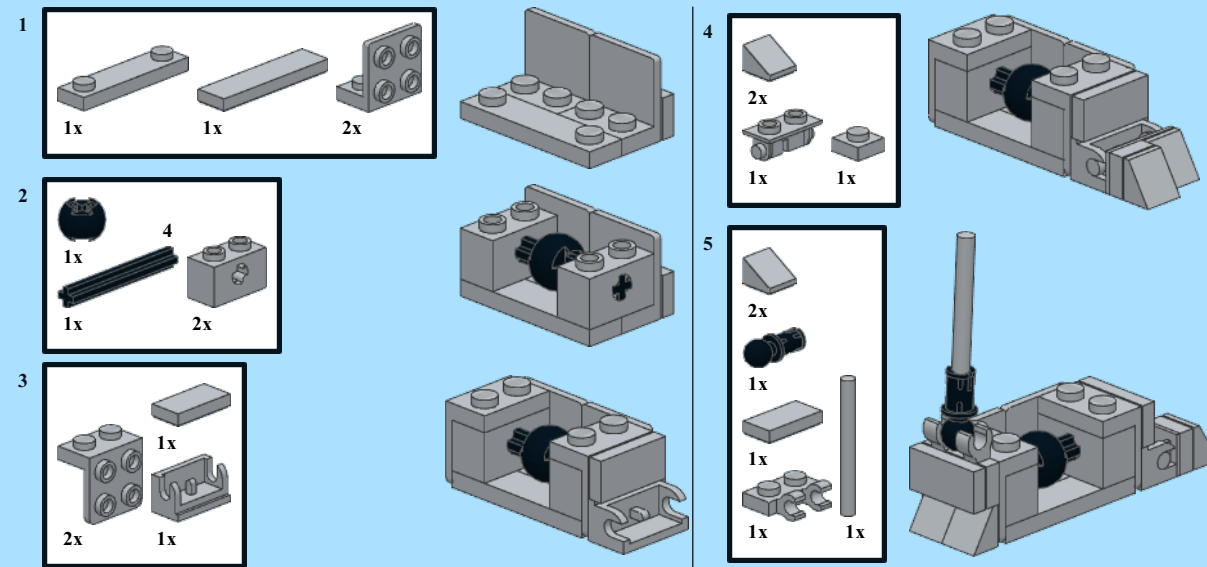

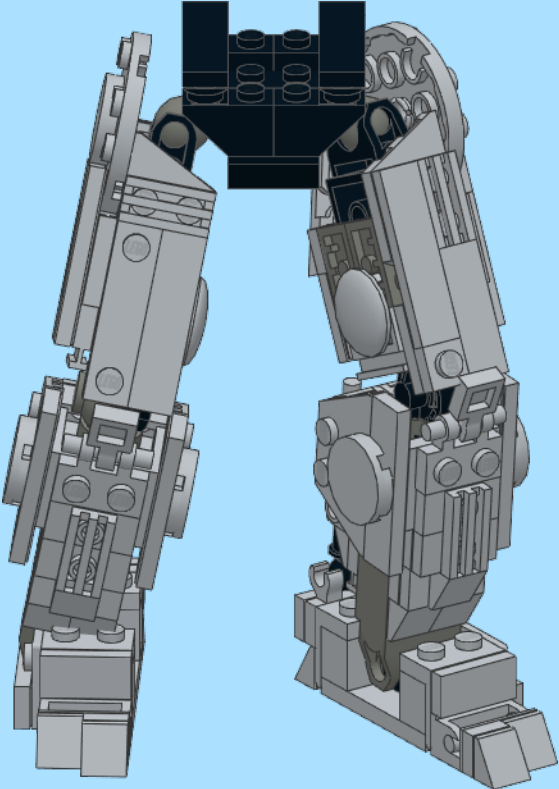

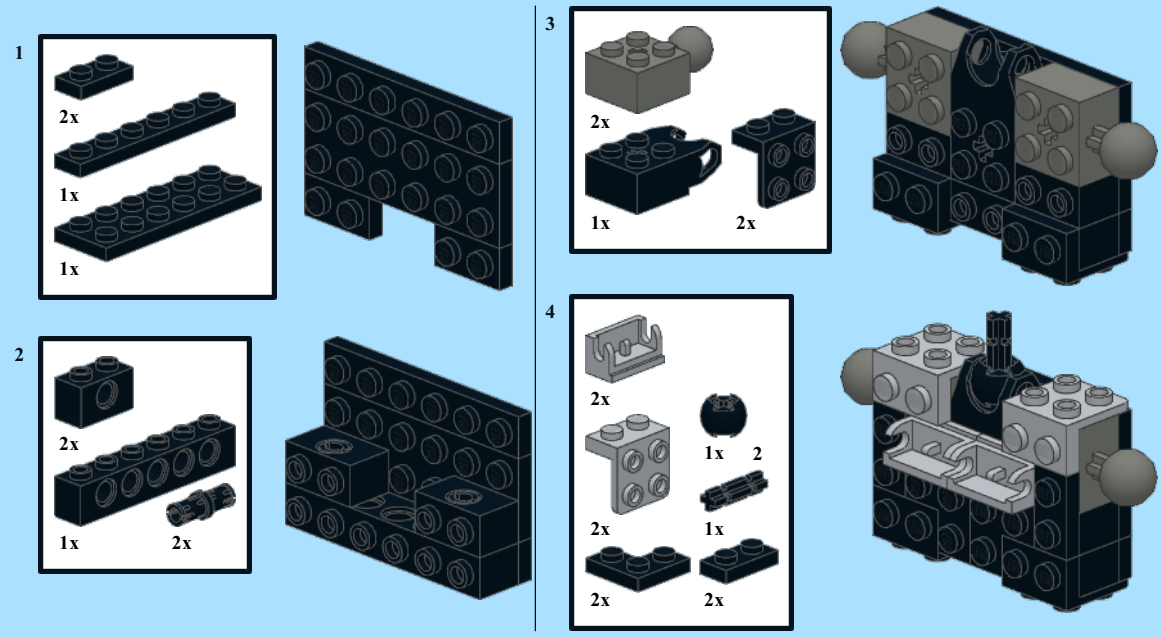

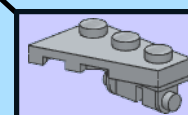
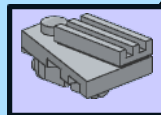
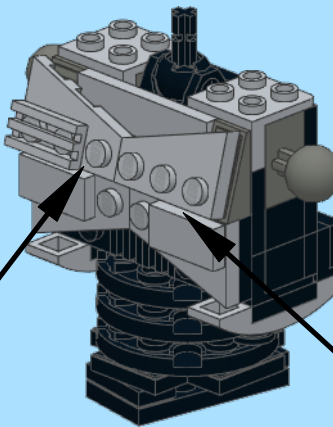
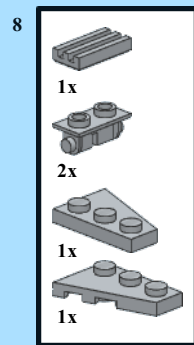
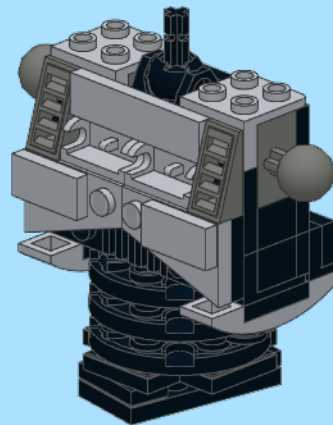
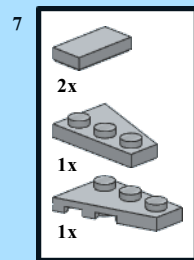
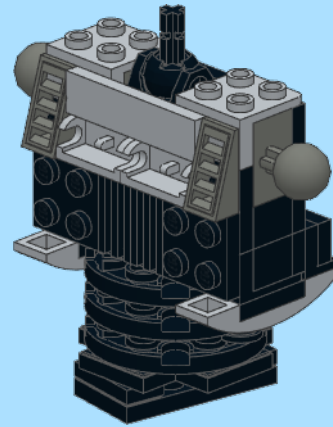
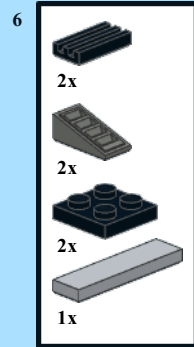

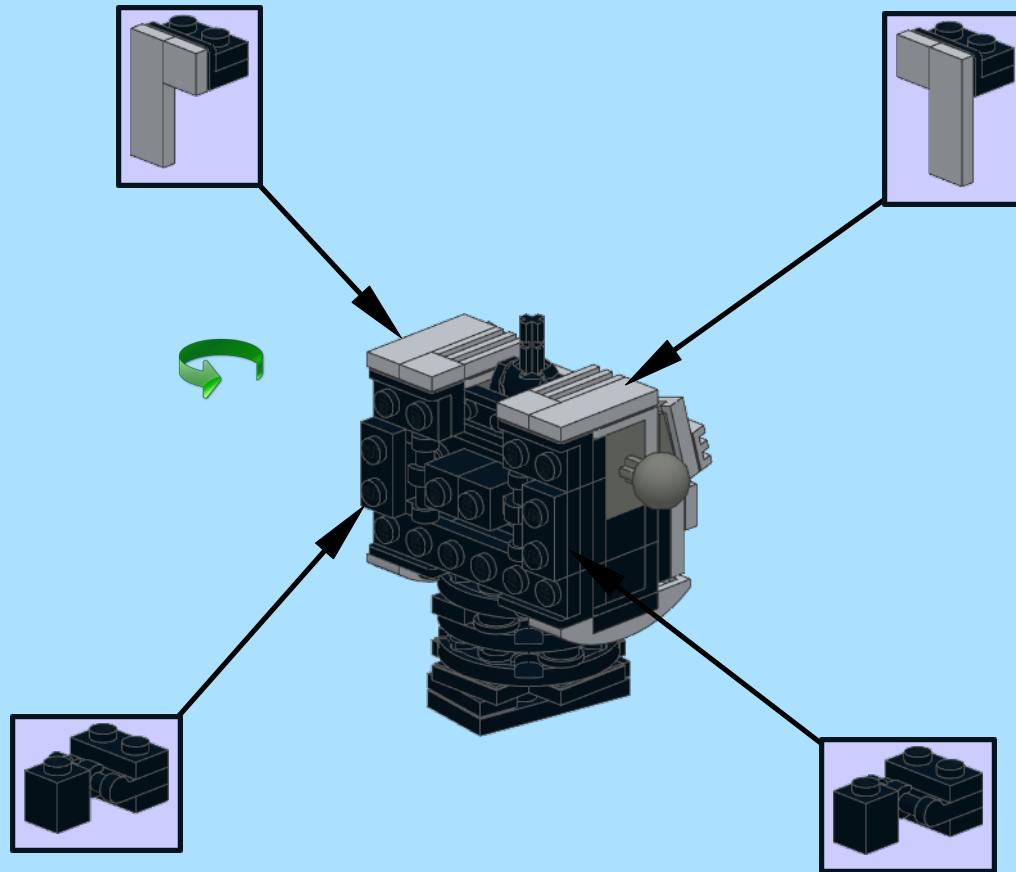
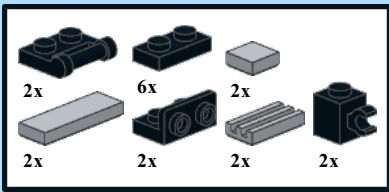

10

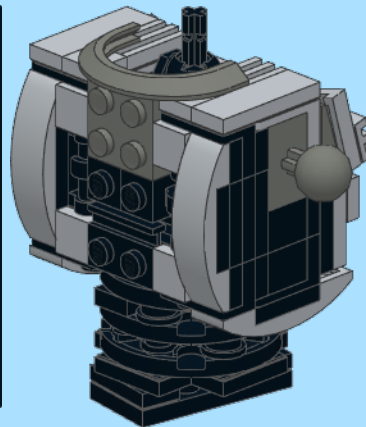
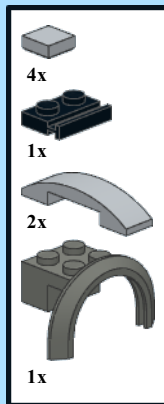

11

