

# Lathe 2.0

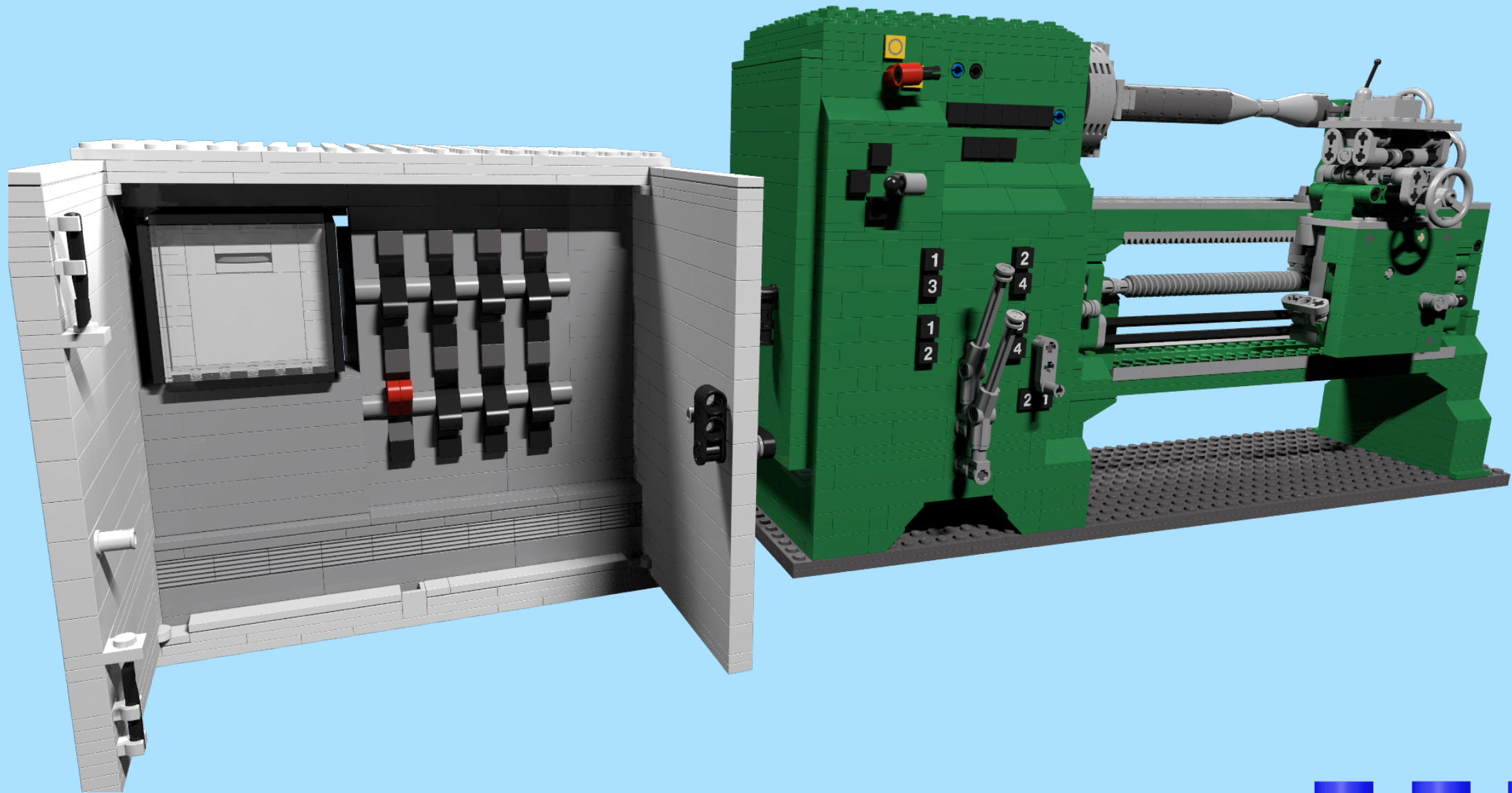

Designed By  
Markus Welz

INSTRUCTION BY  
**KNUD ALBRECHTSEN**  
[www.snakebyte.dk/lego](http://www.snakebyte.dk/lego)

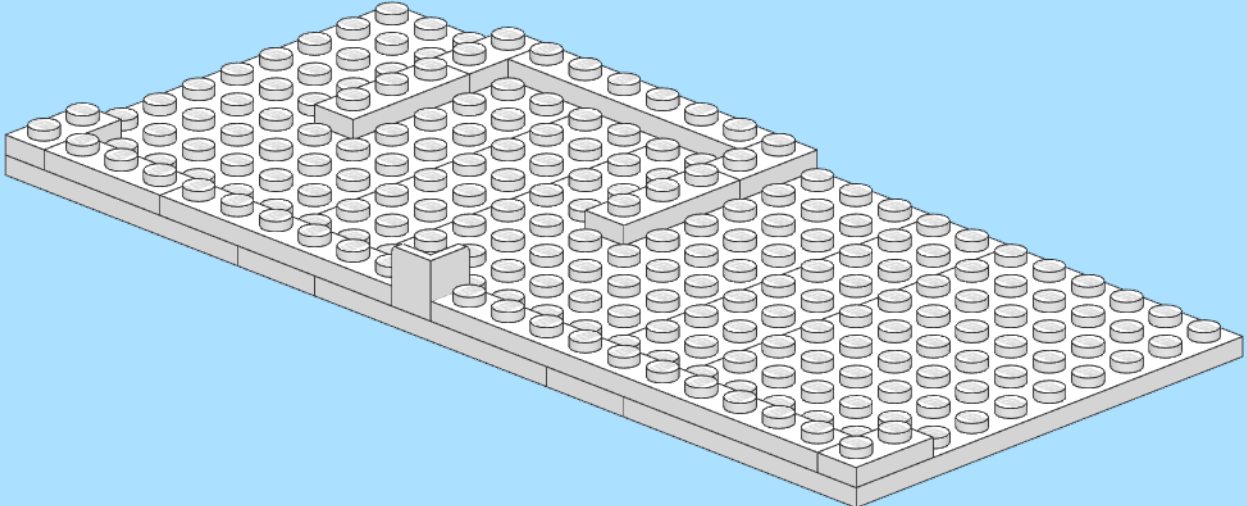
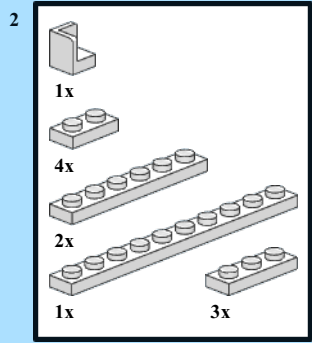
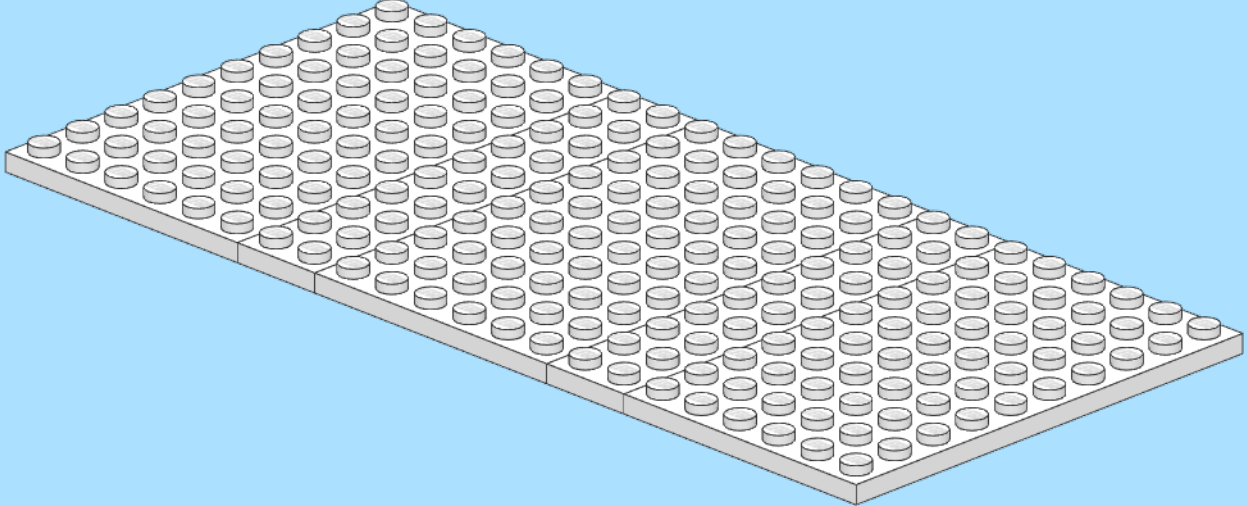
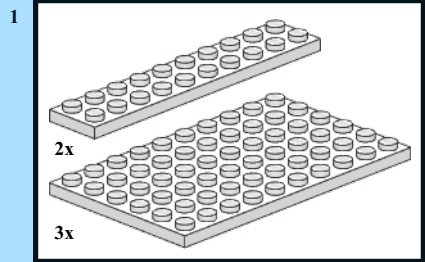



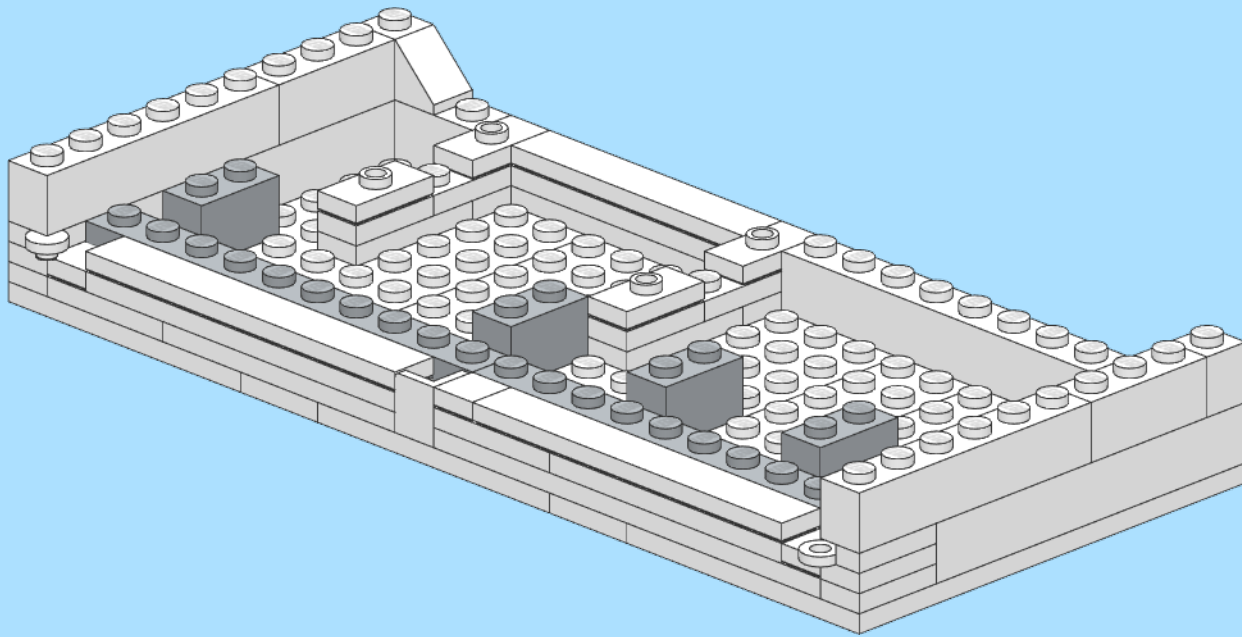
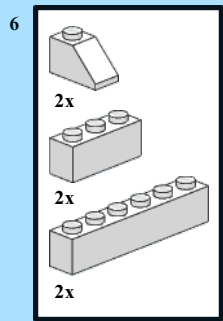
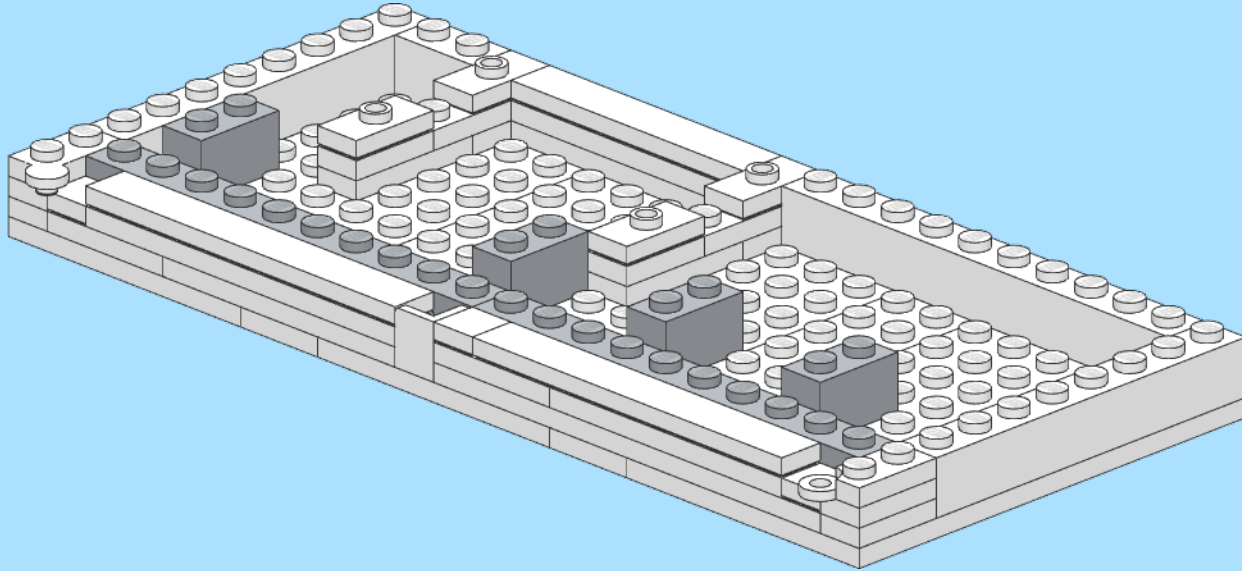
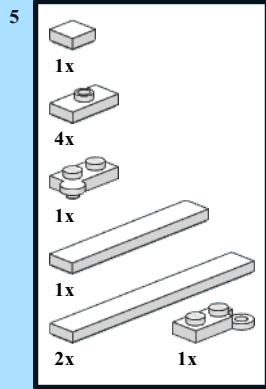

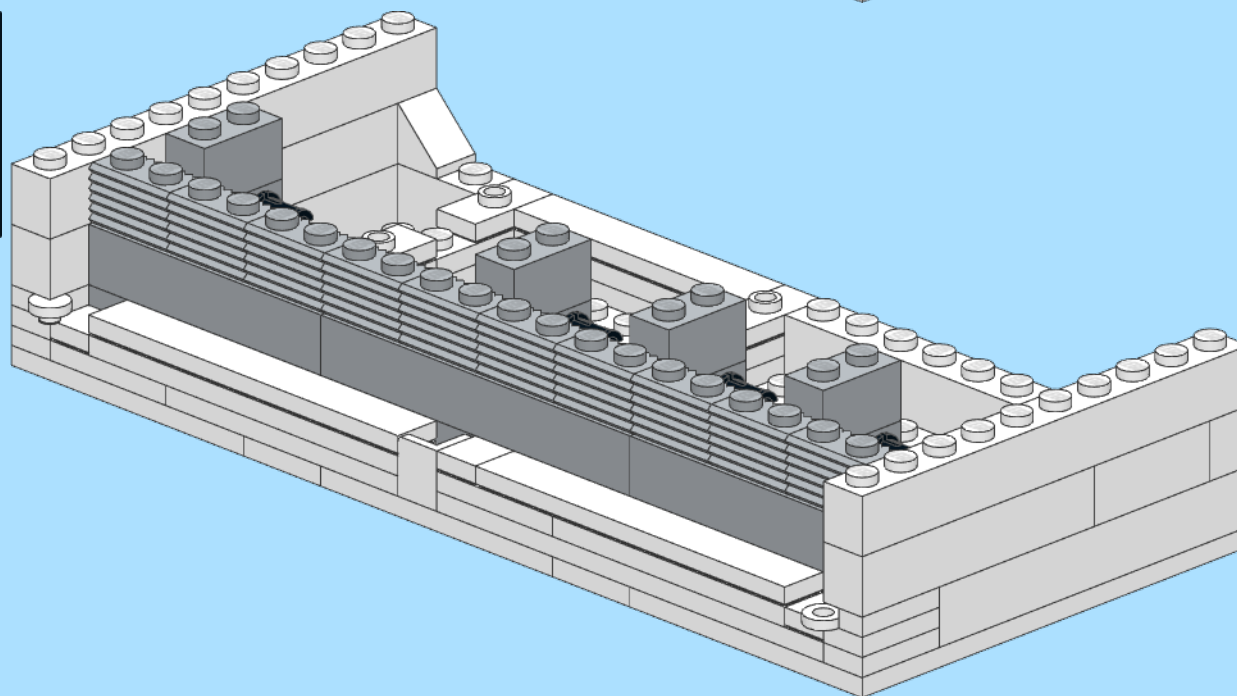
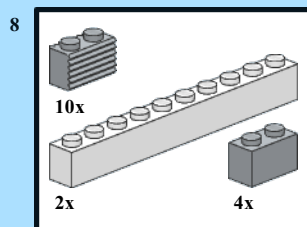
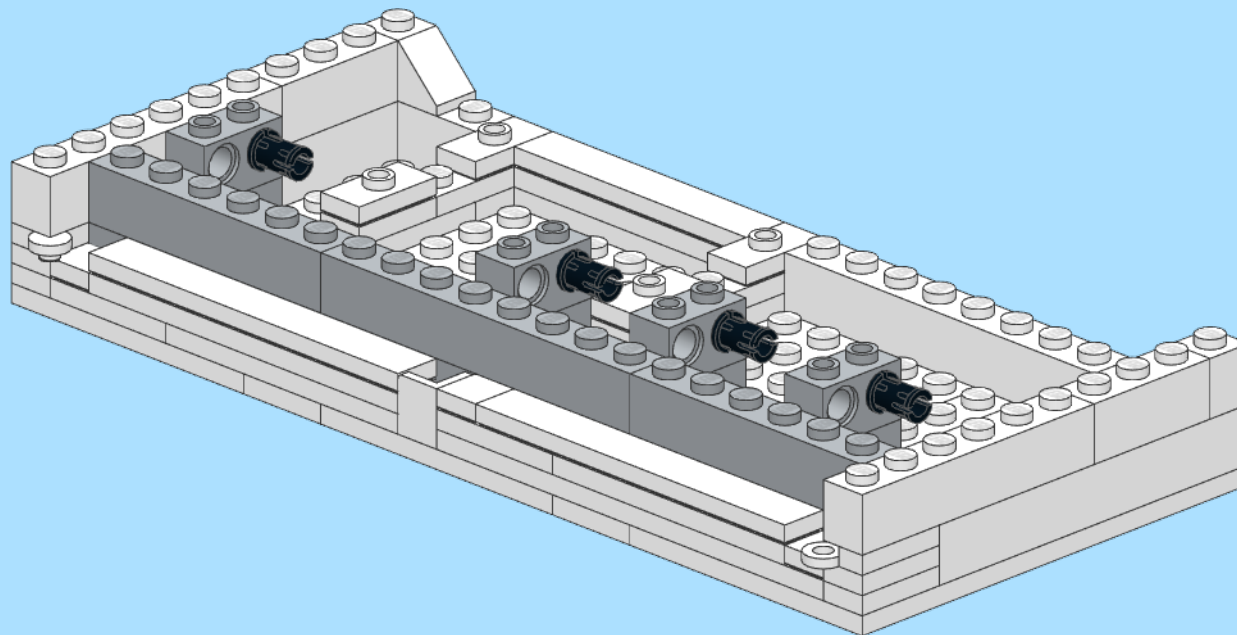
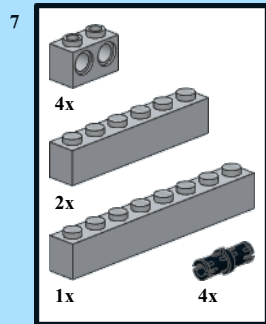

9

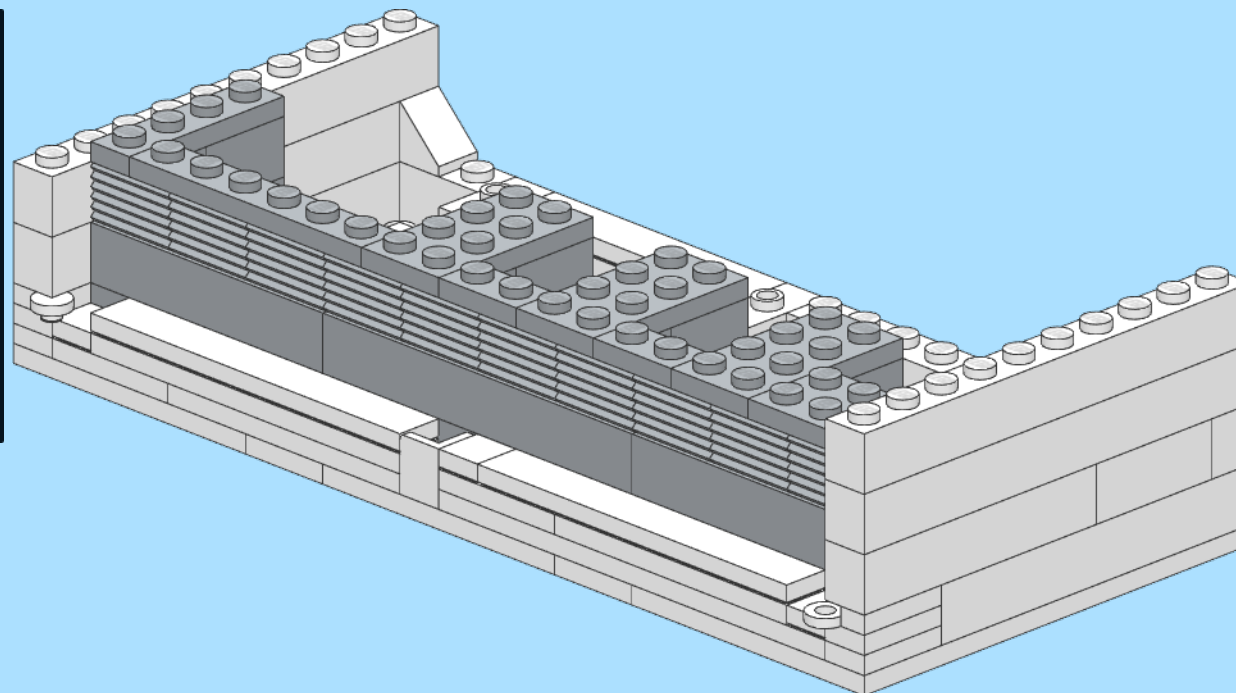
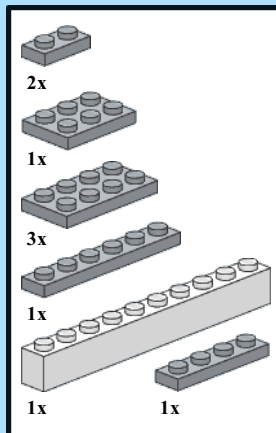

10

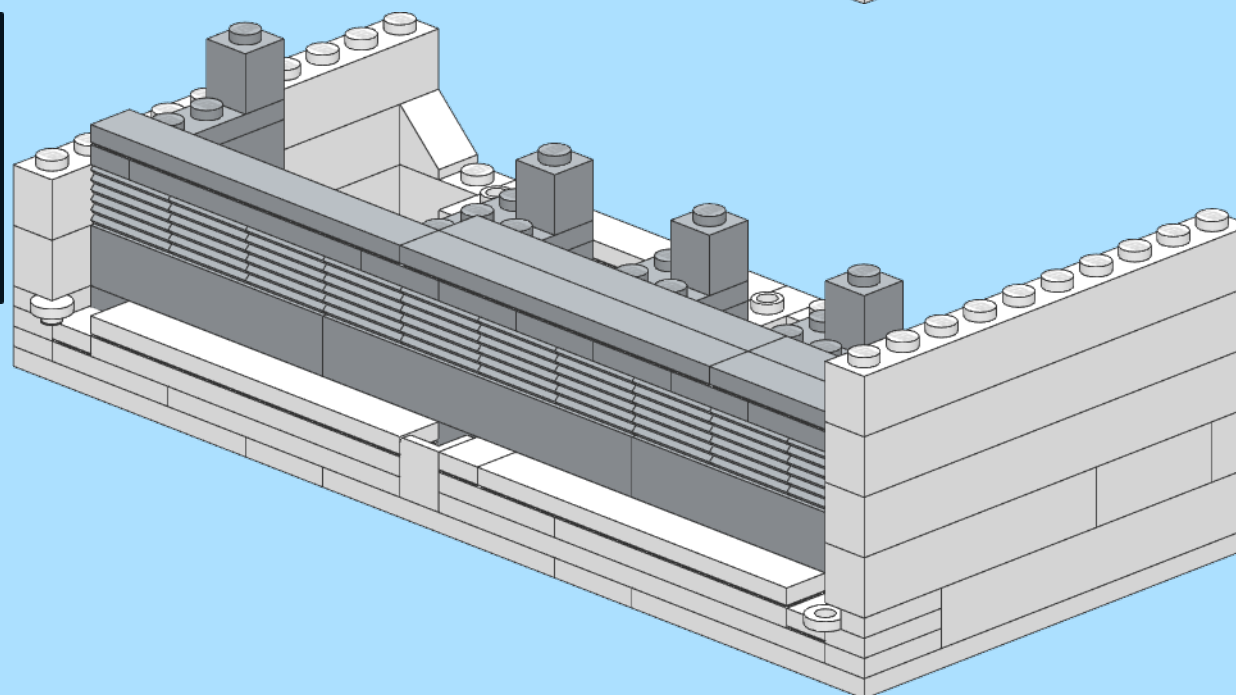
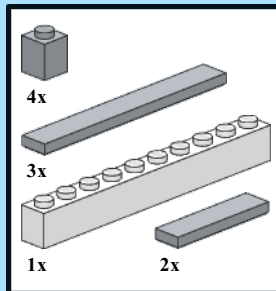

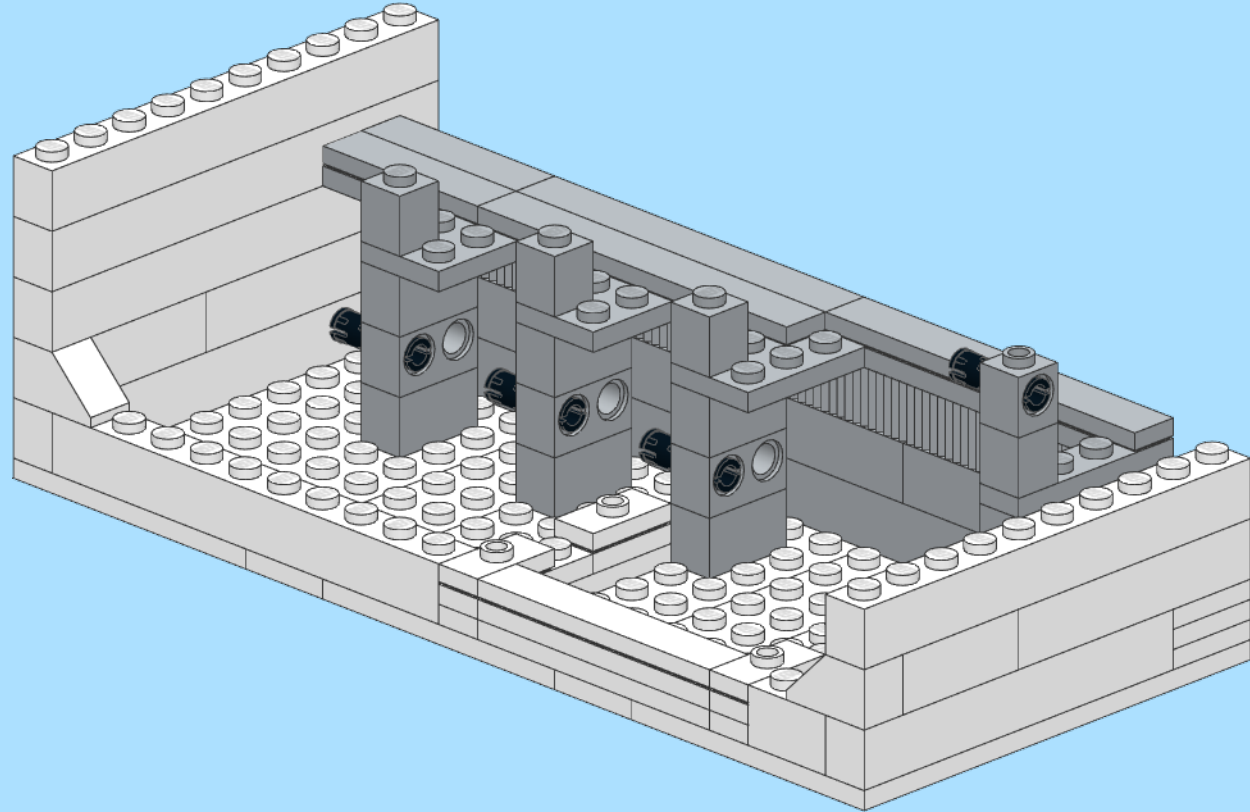

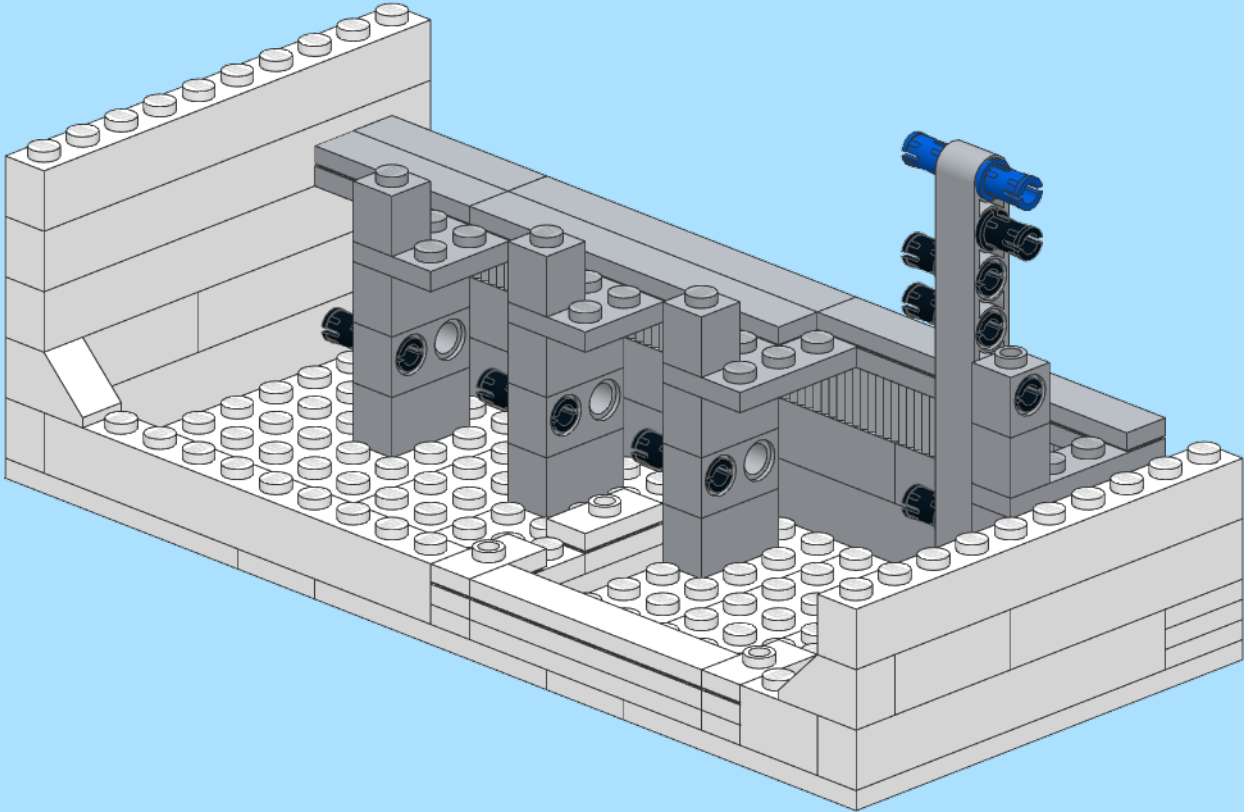
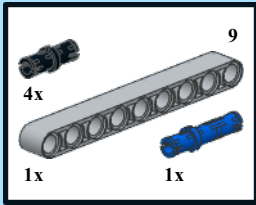



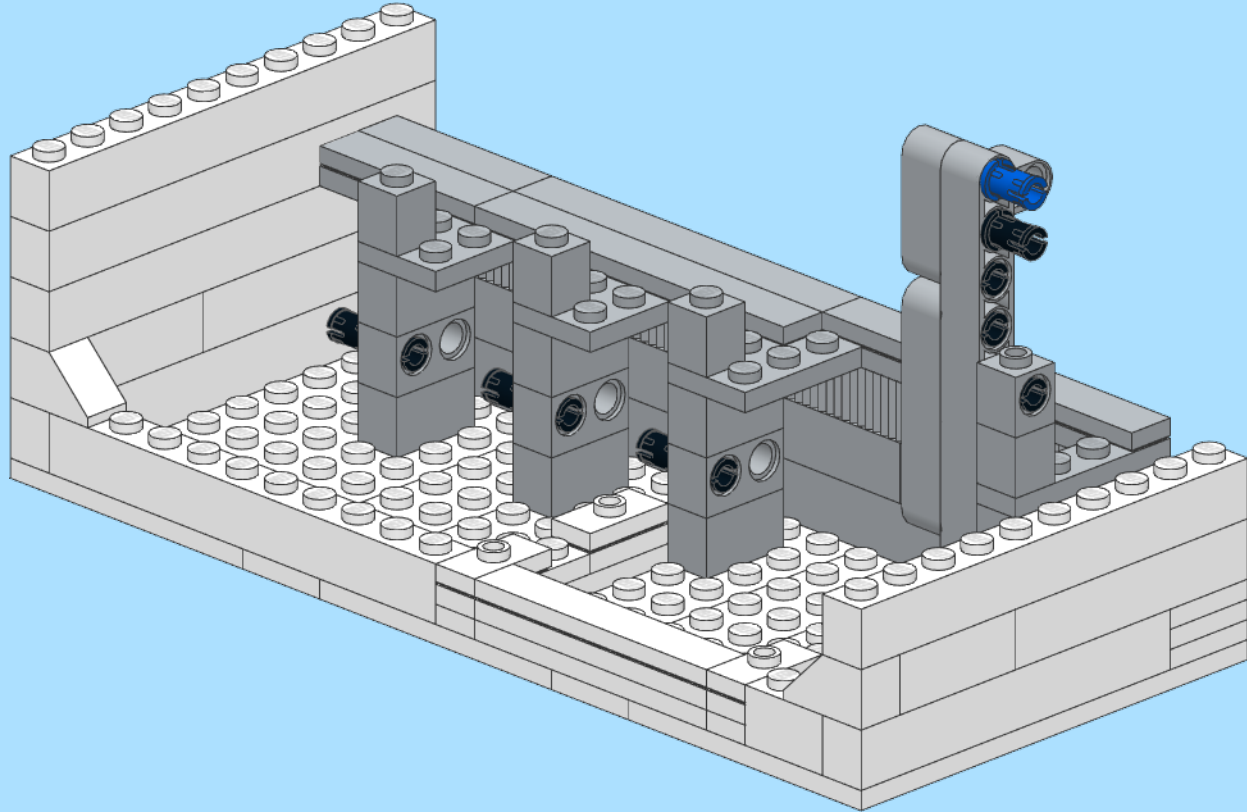
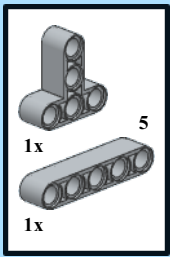

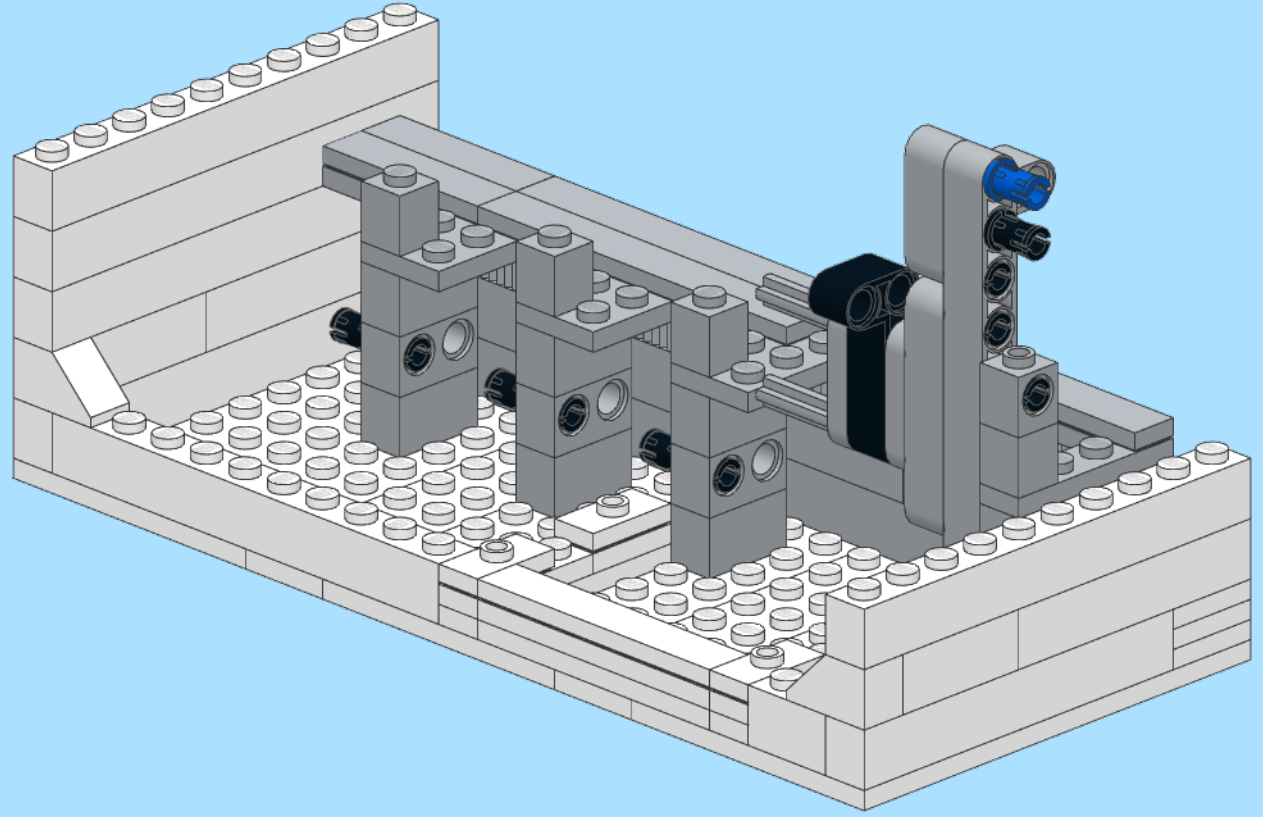
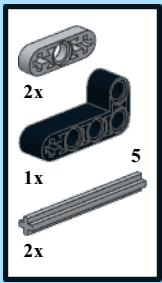

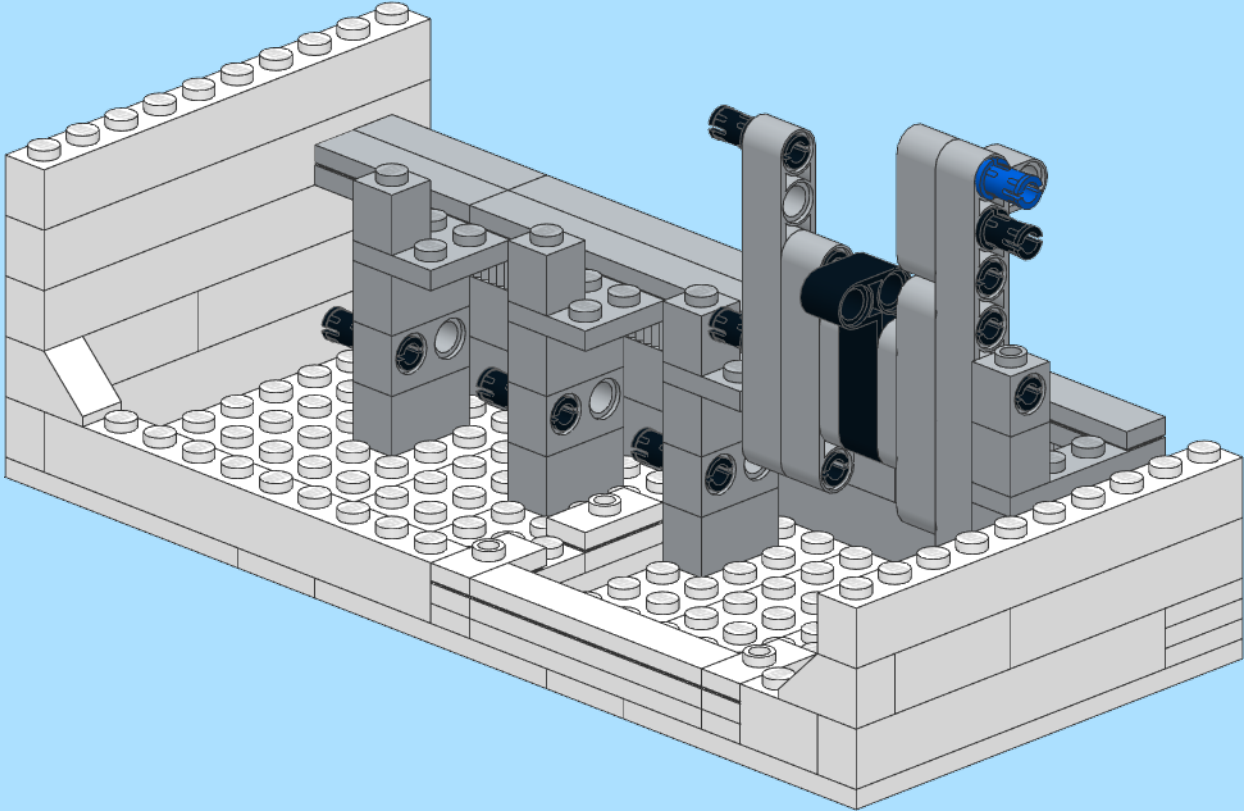
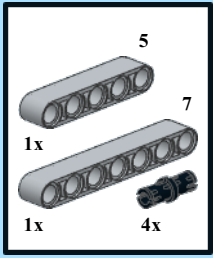

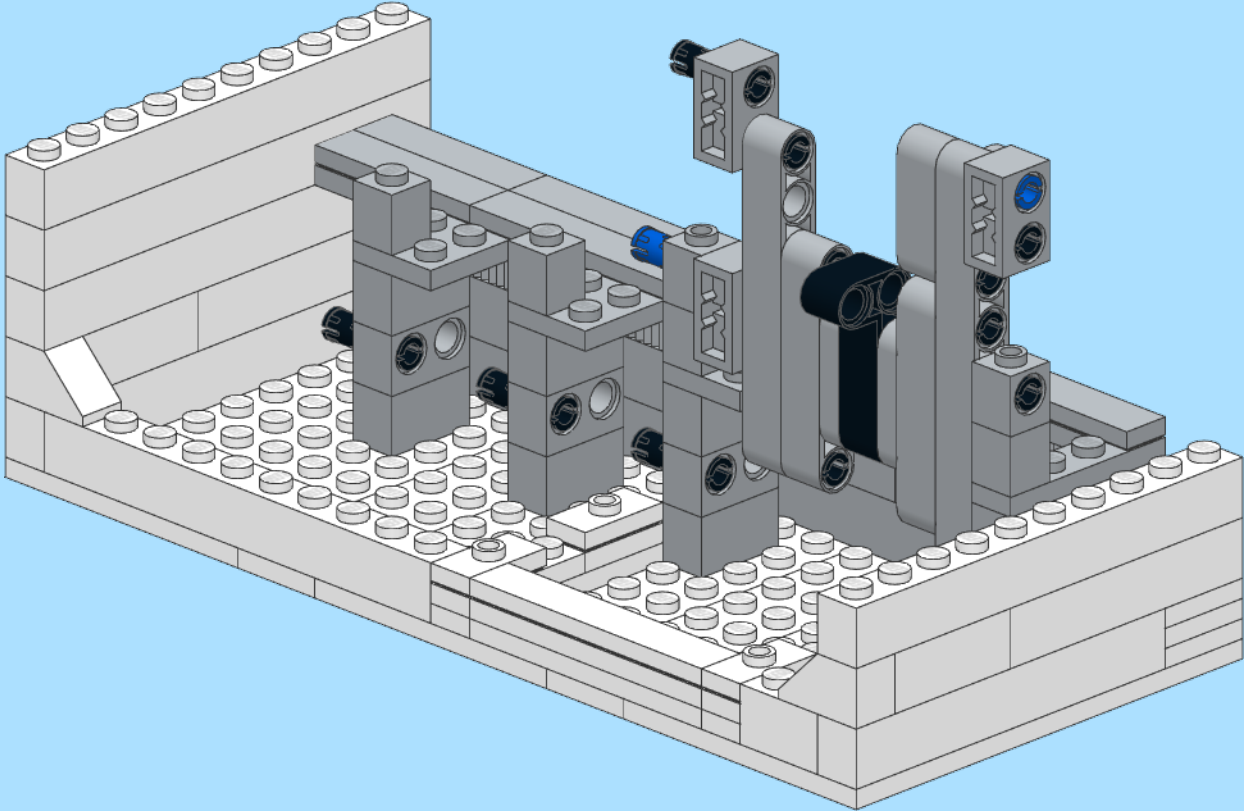
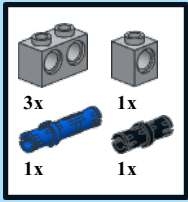

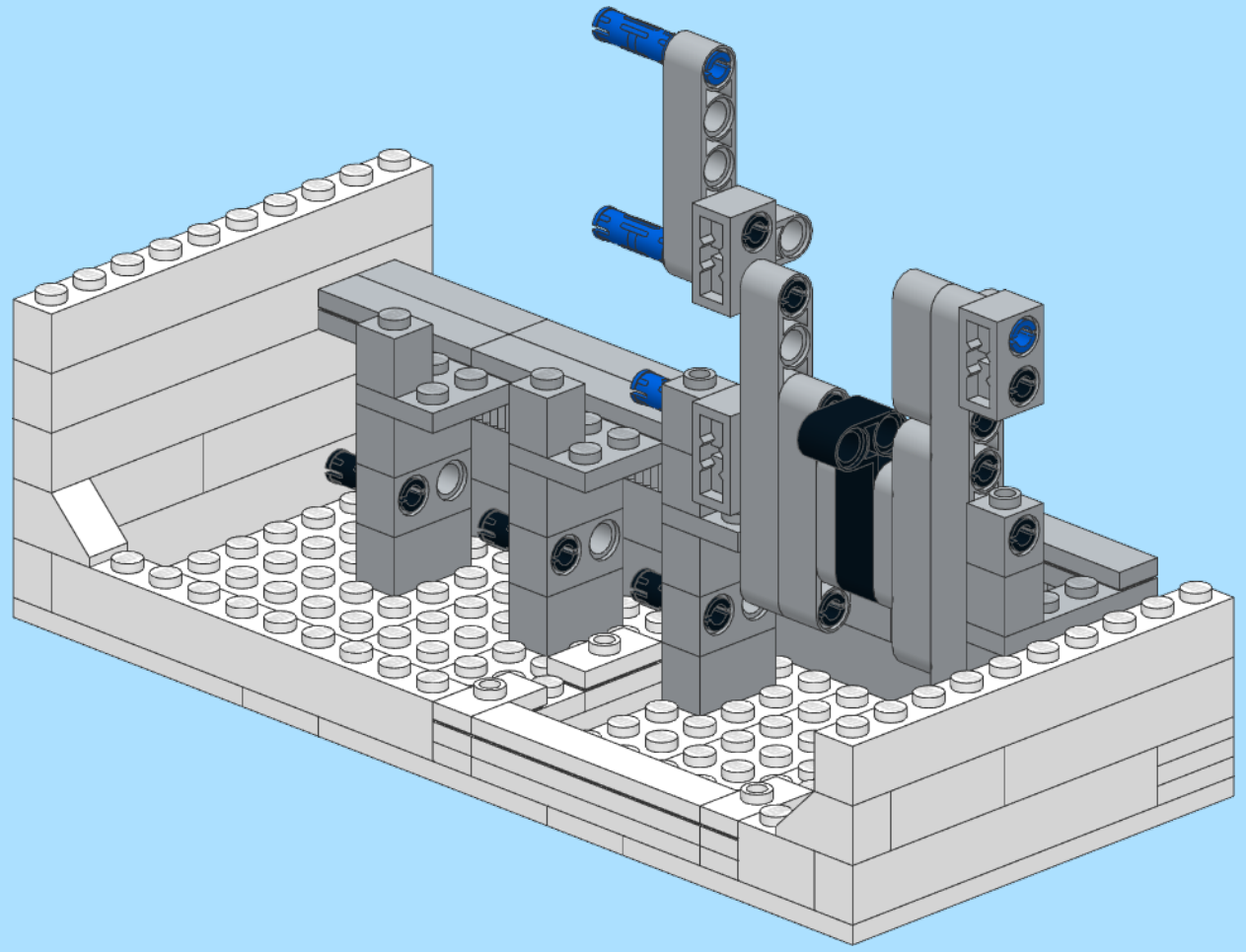
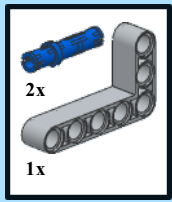

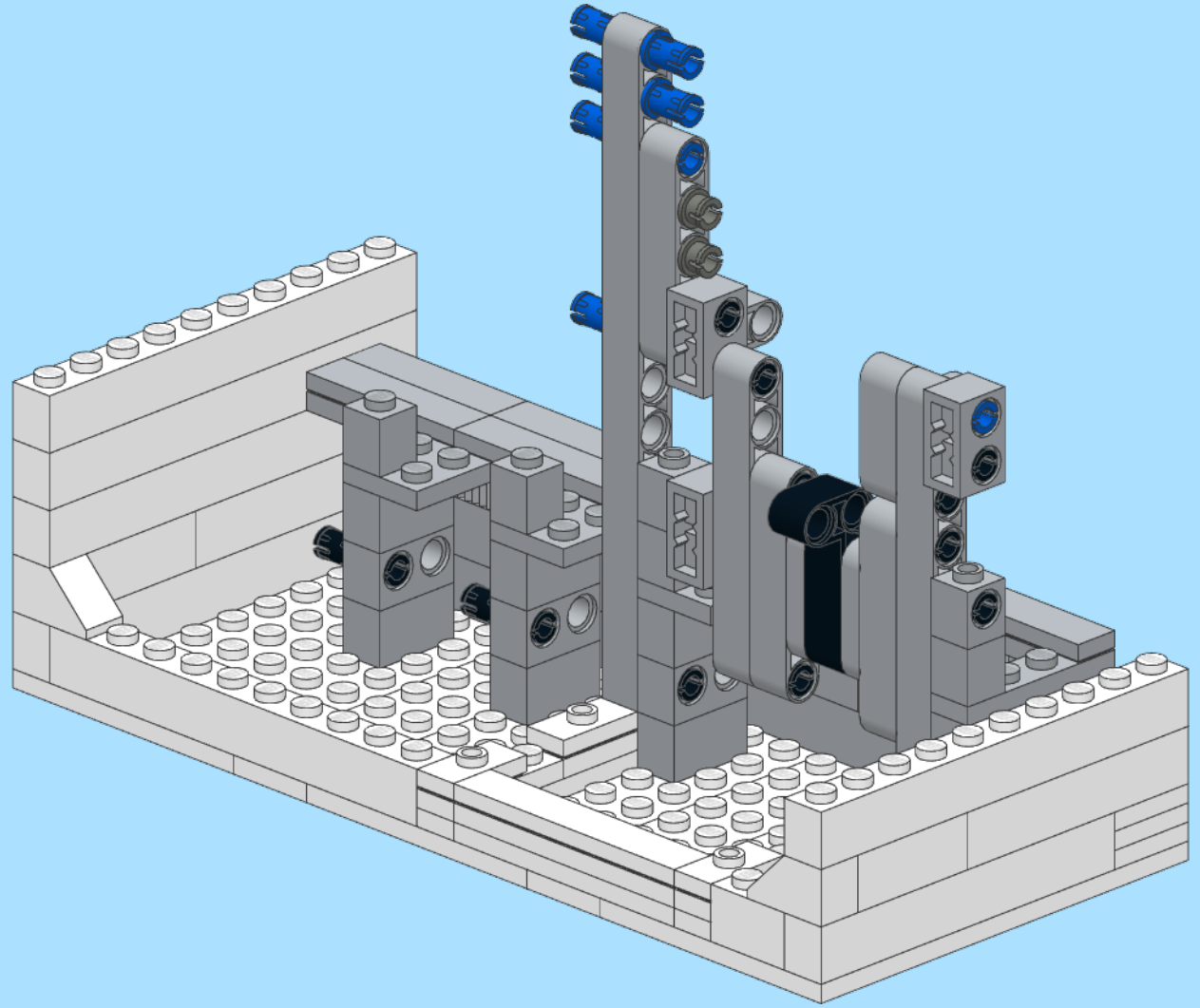
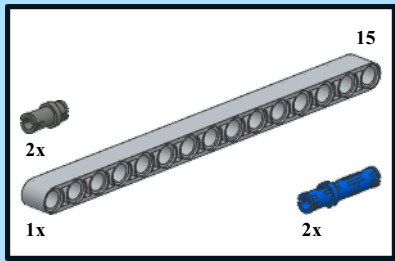

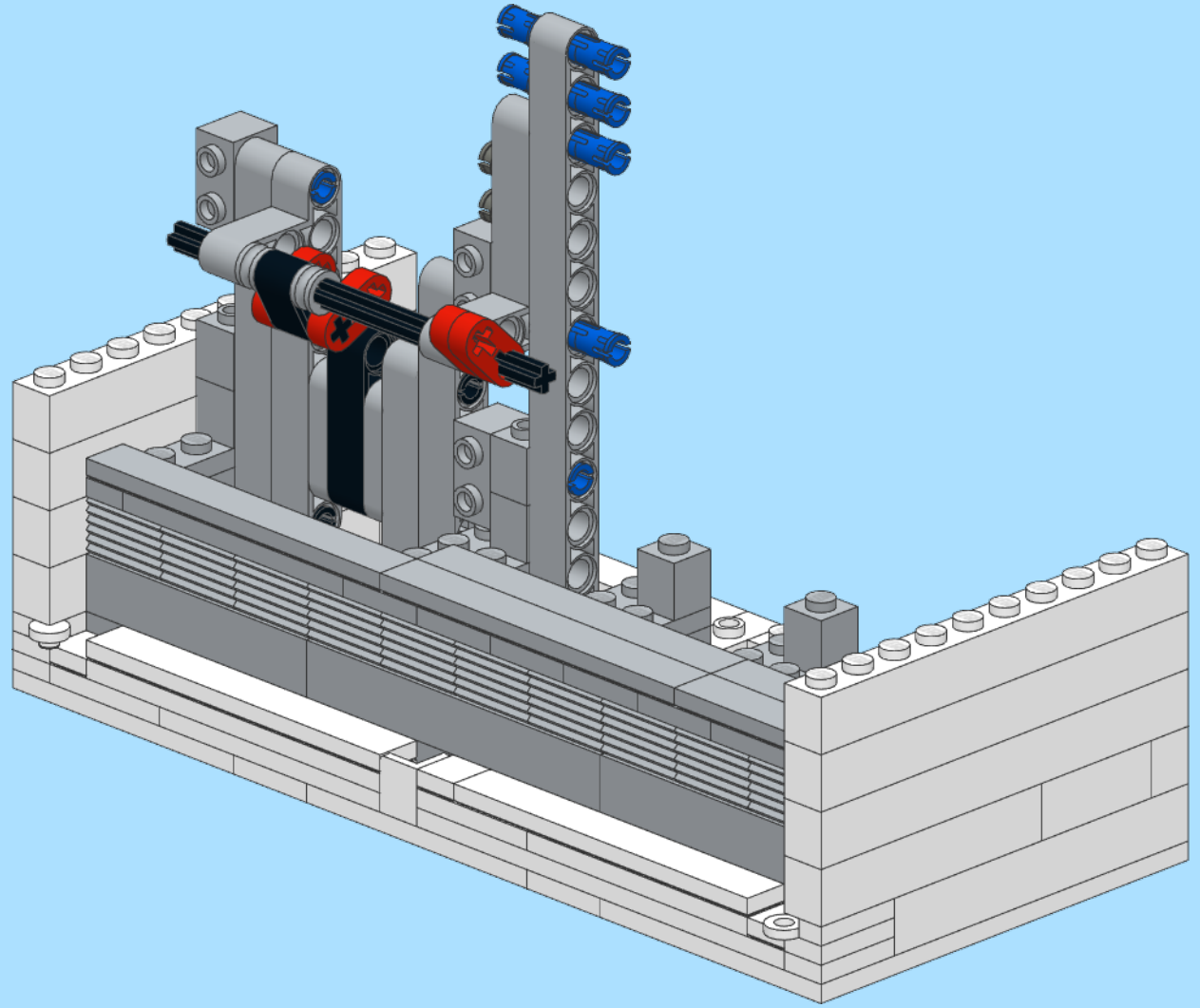
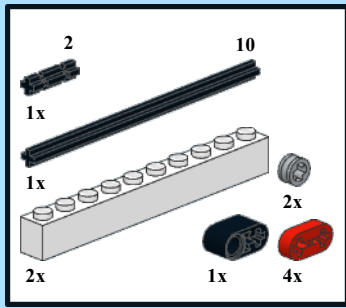

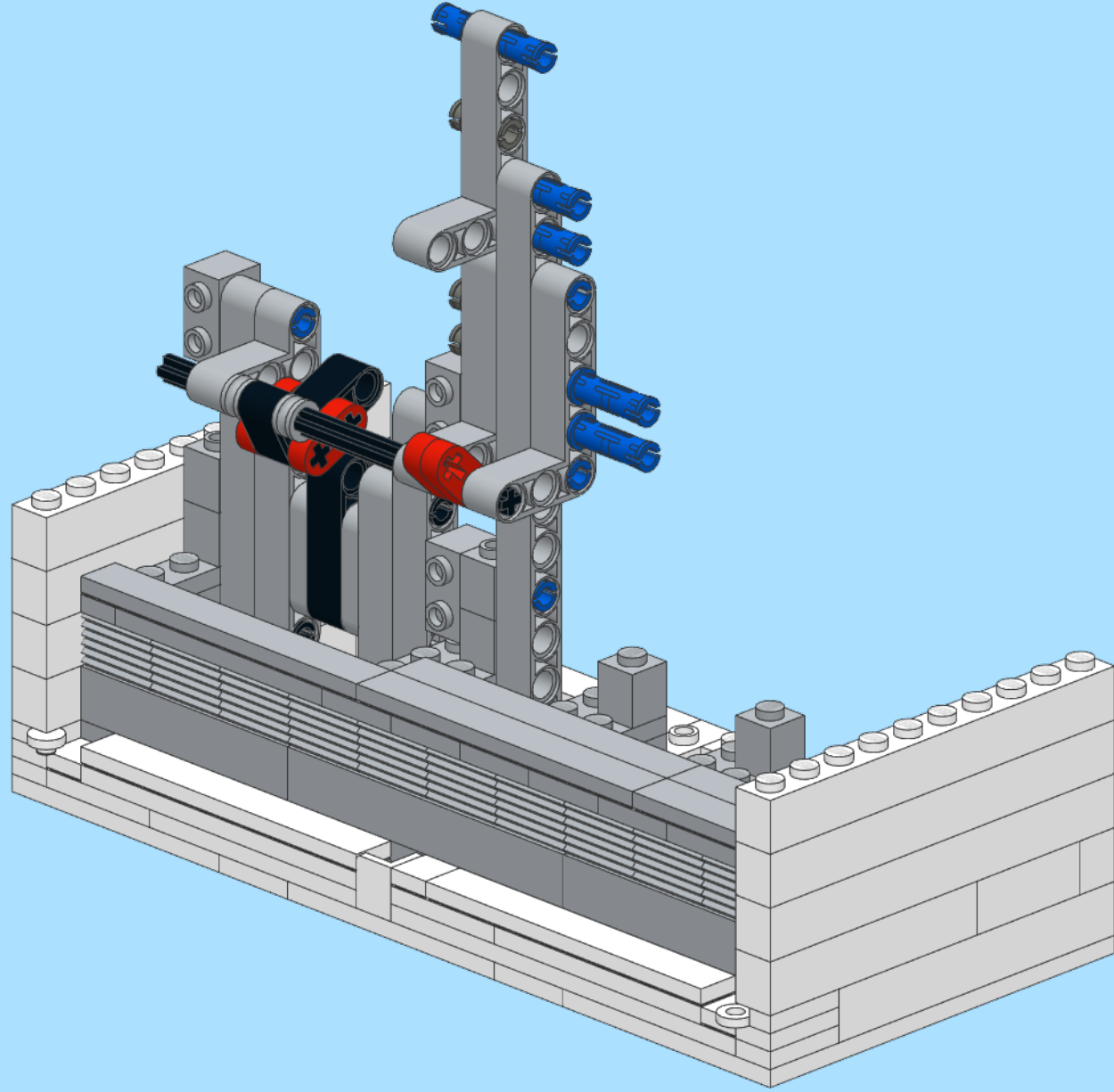
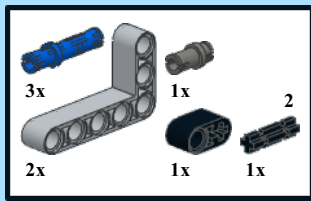



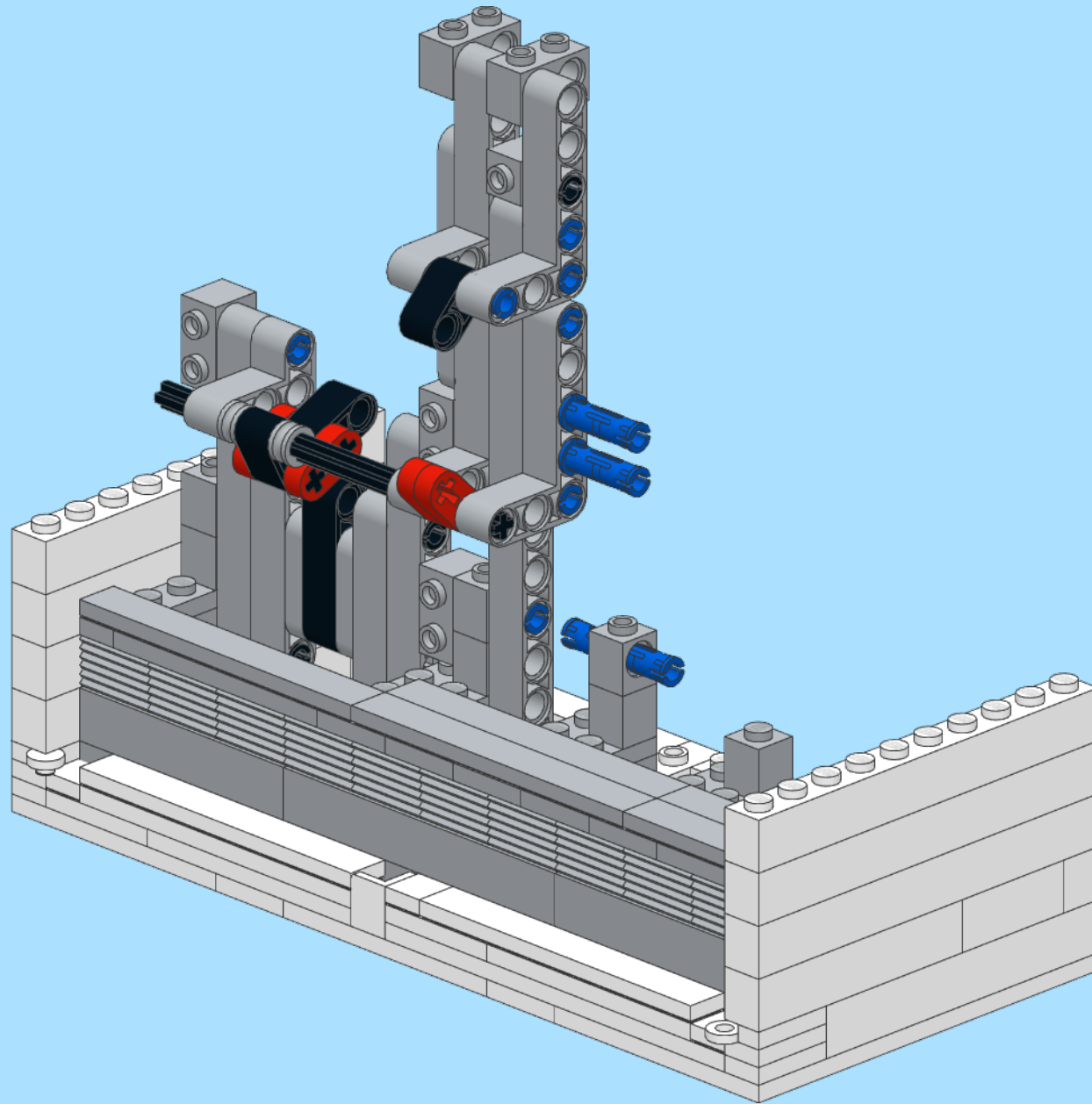
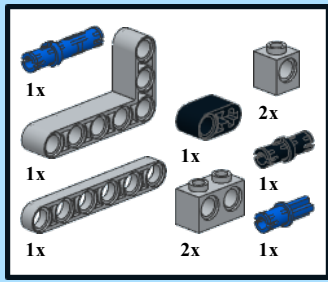

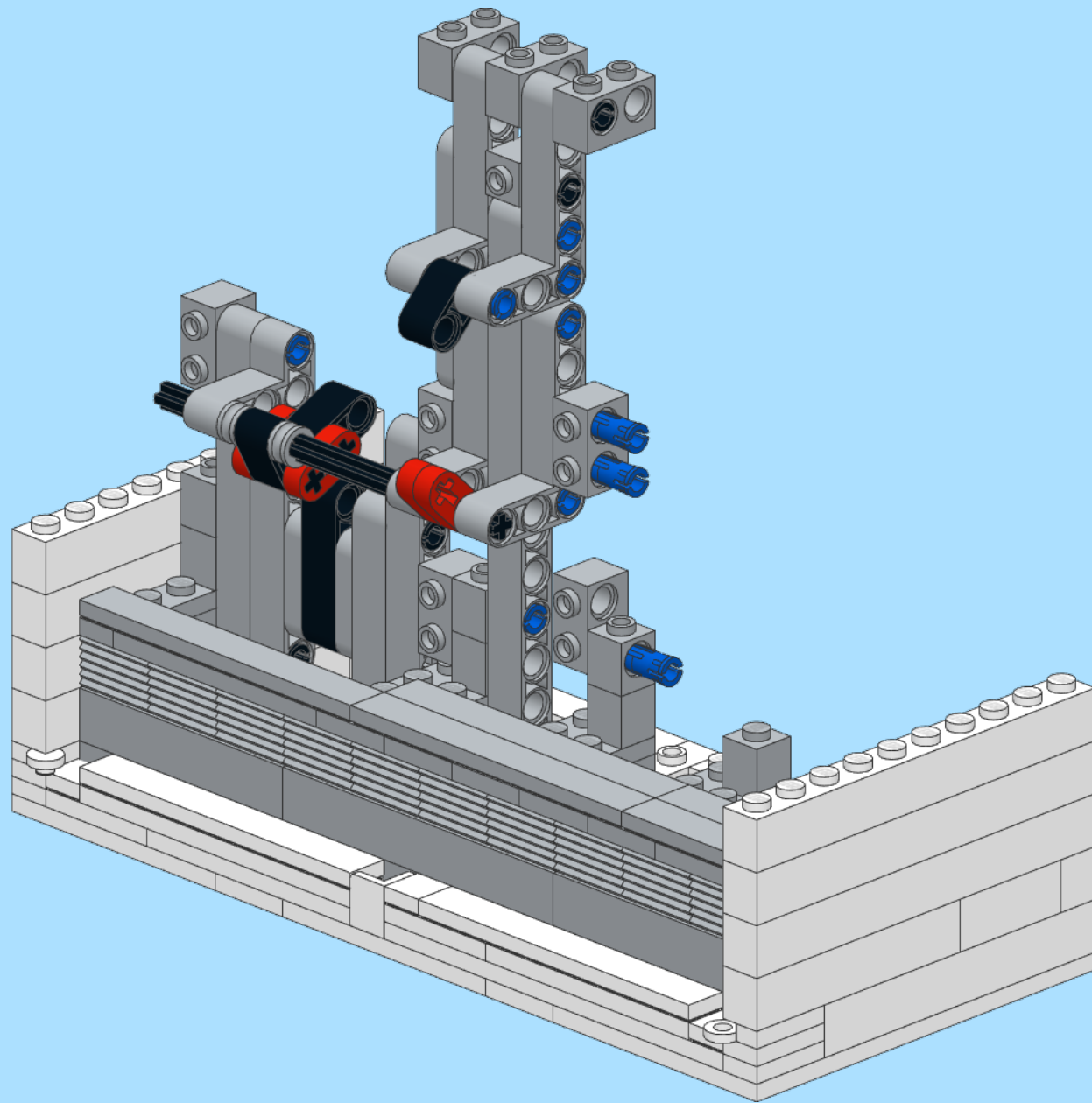

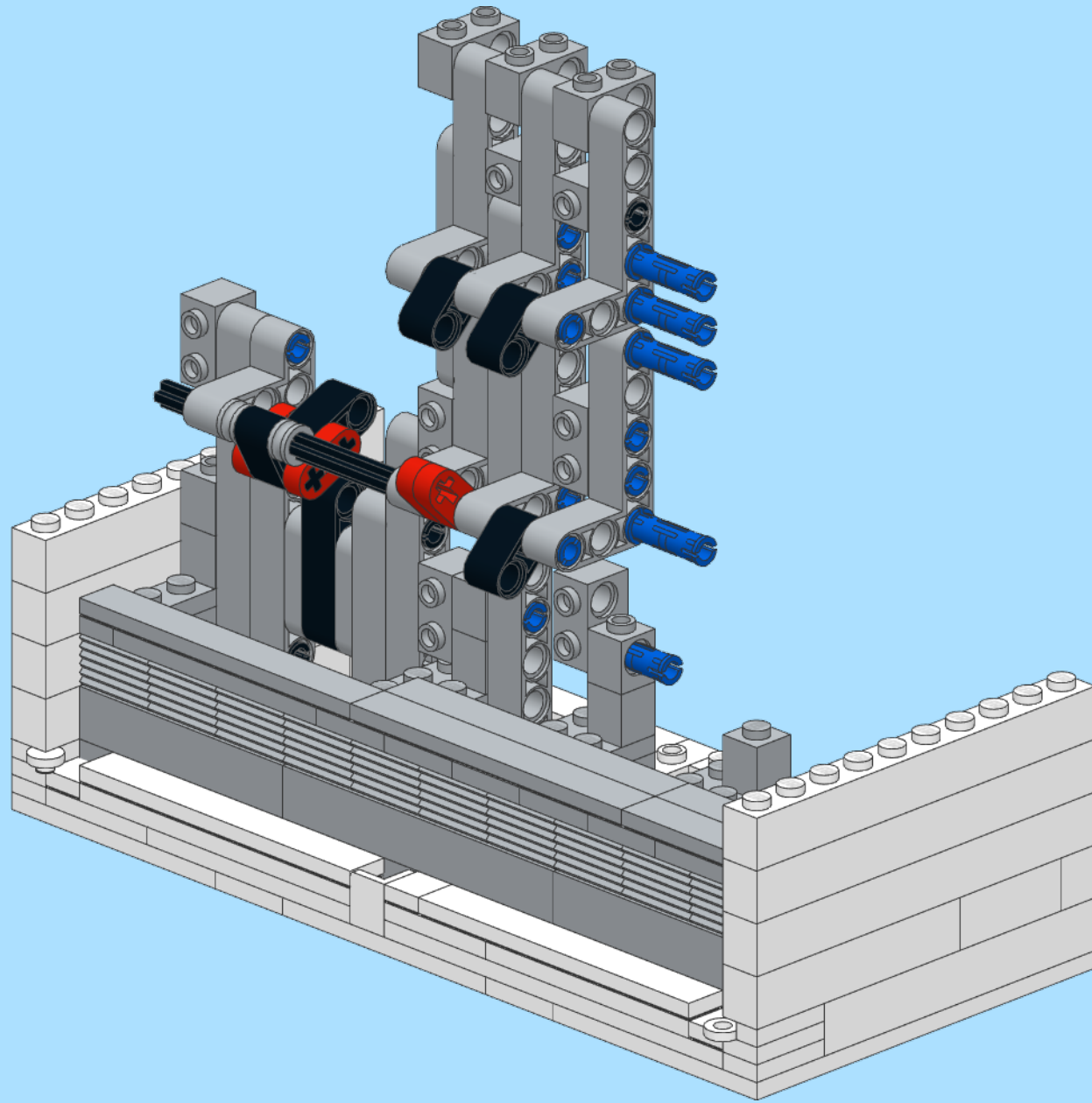
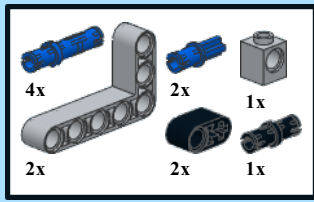

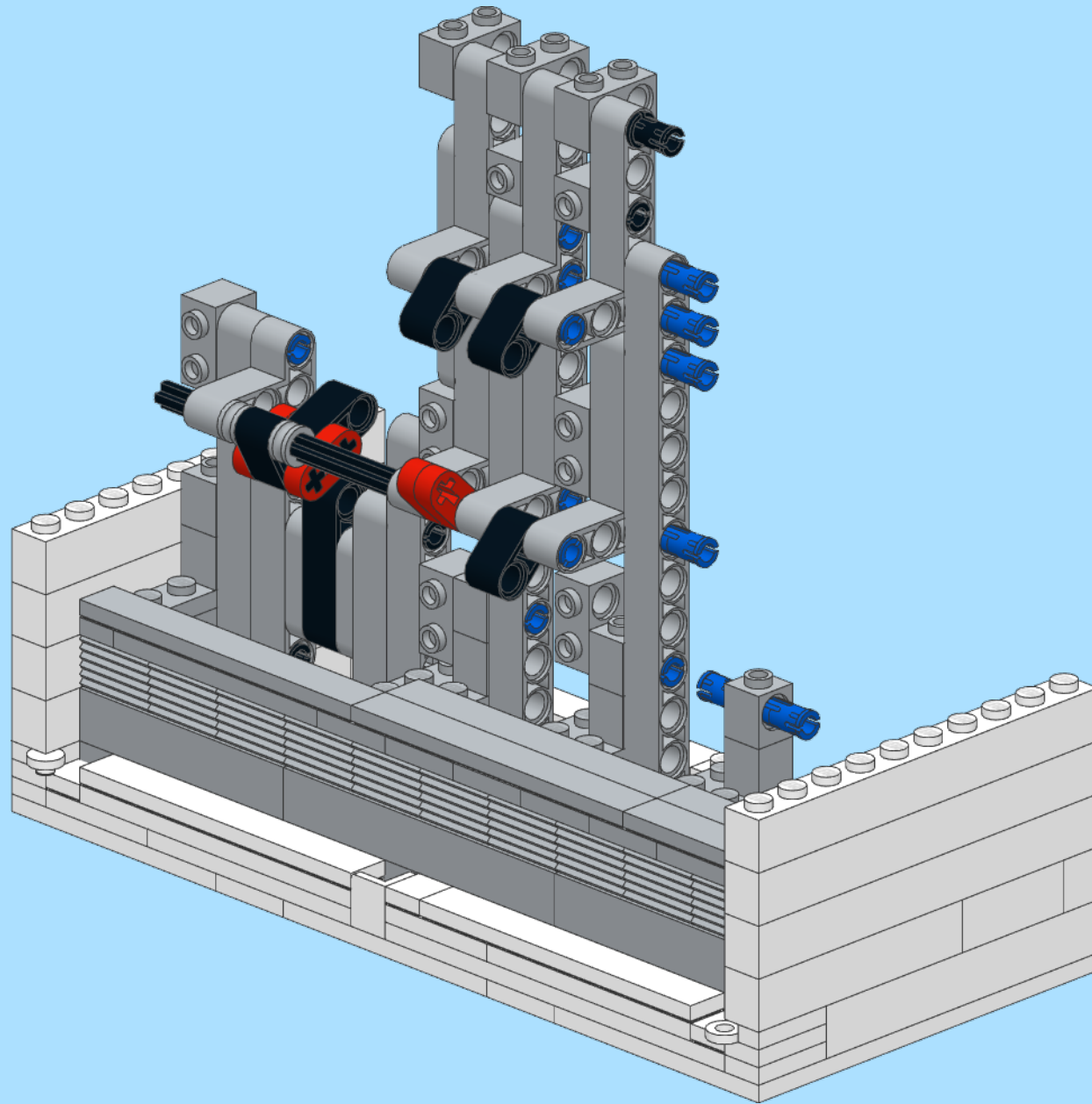
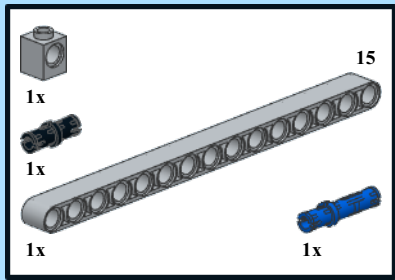

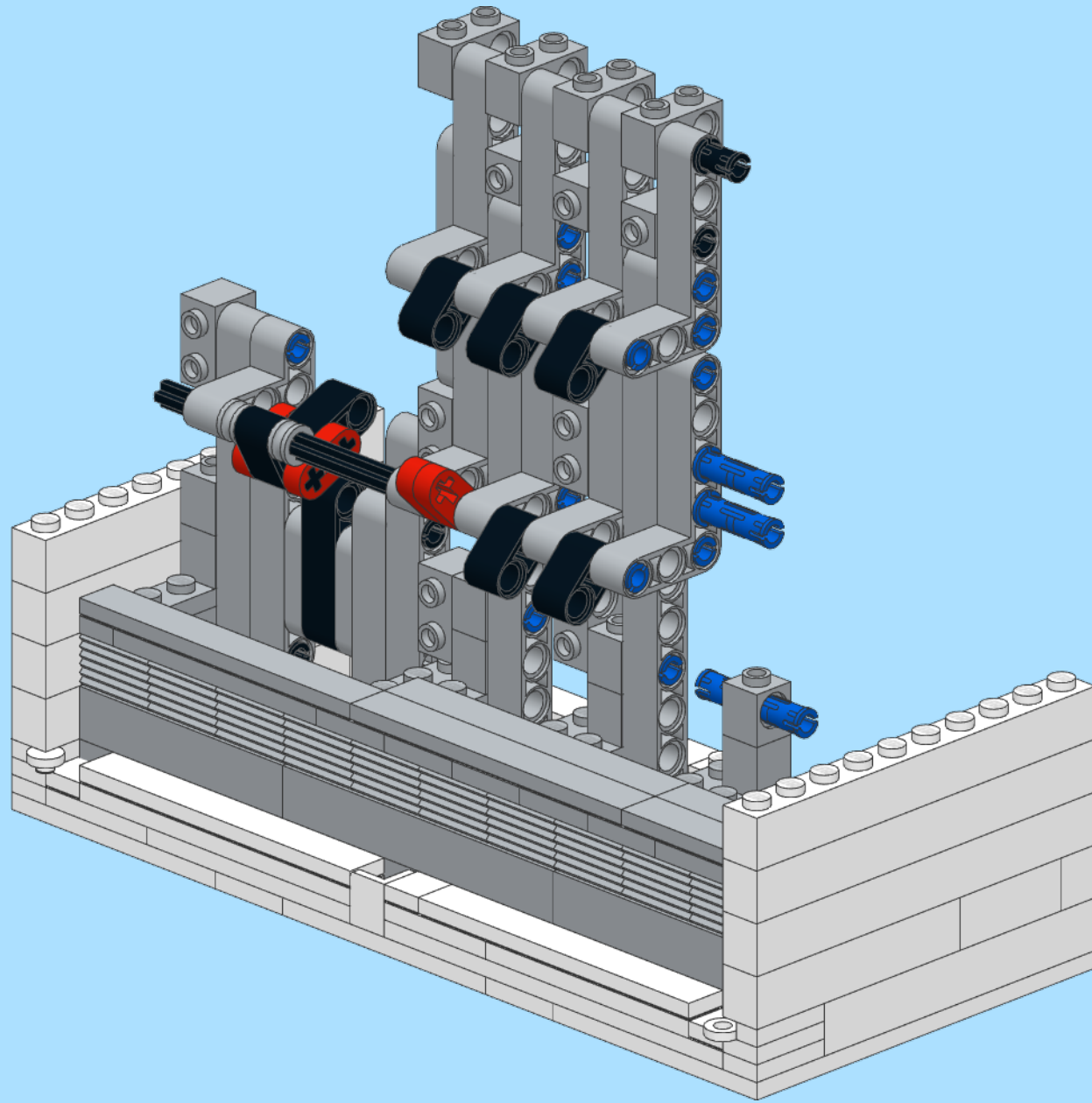
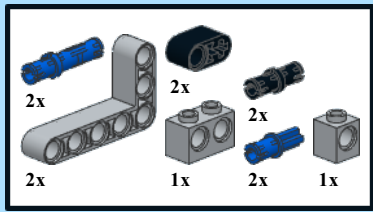

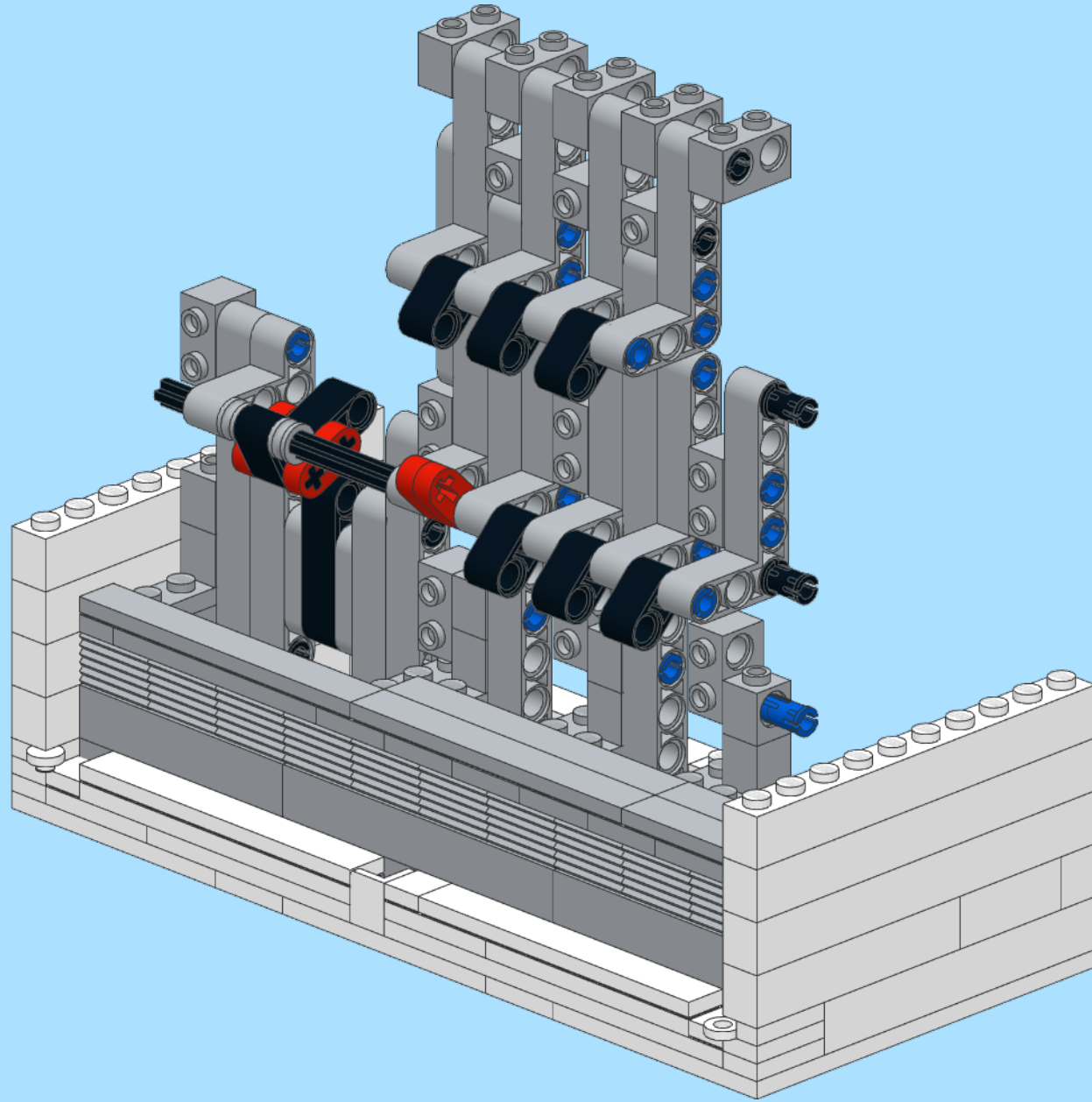
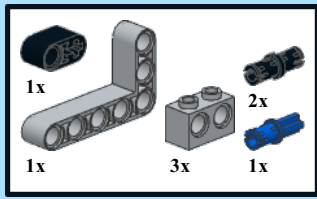

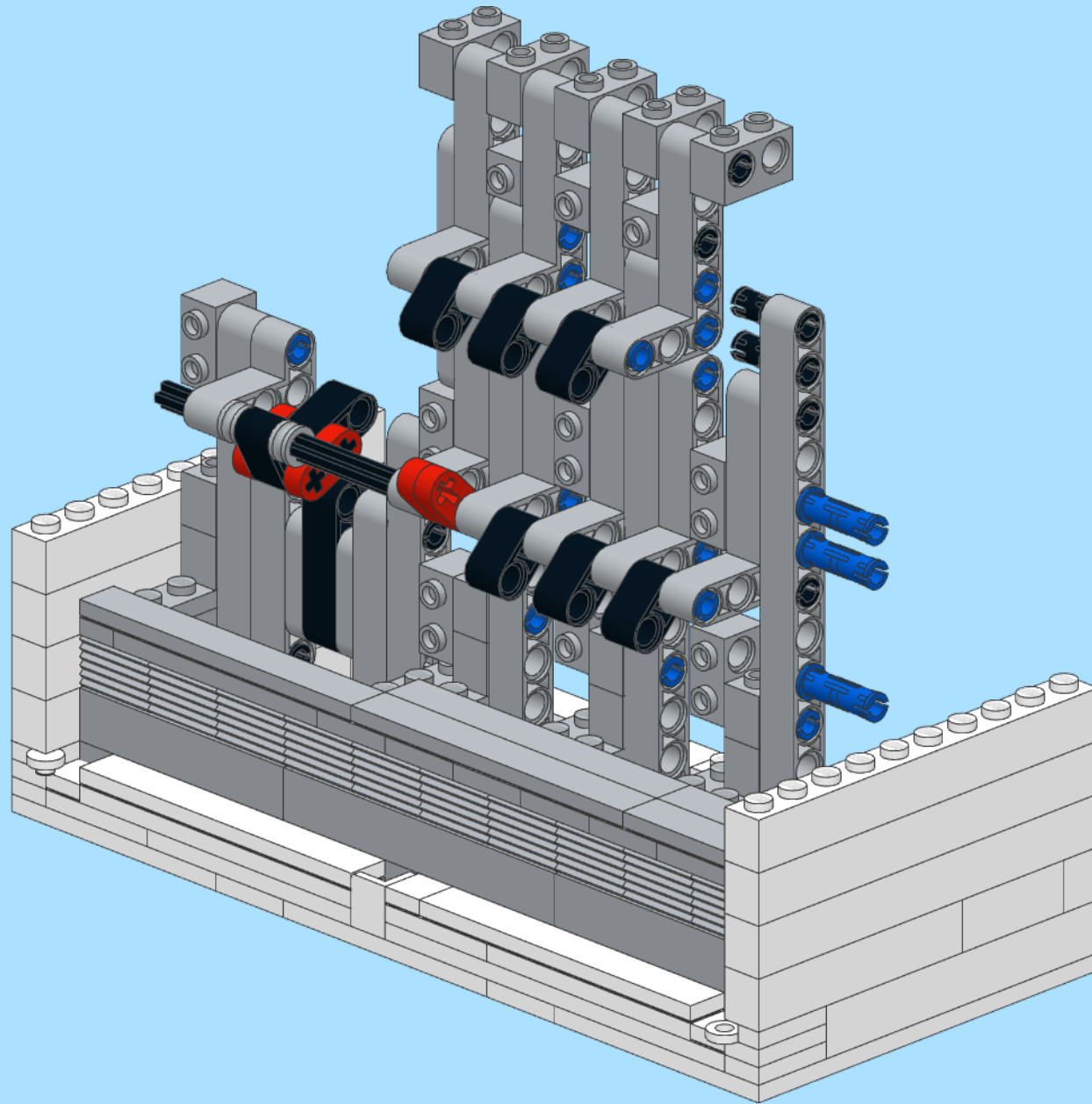
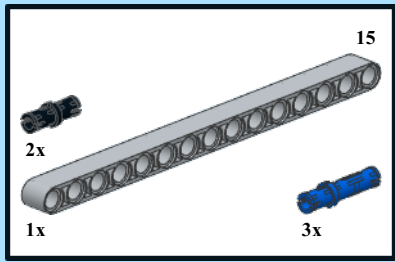

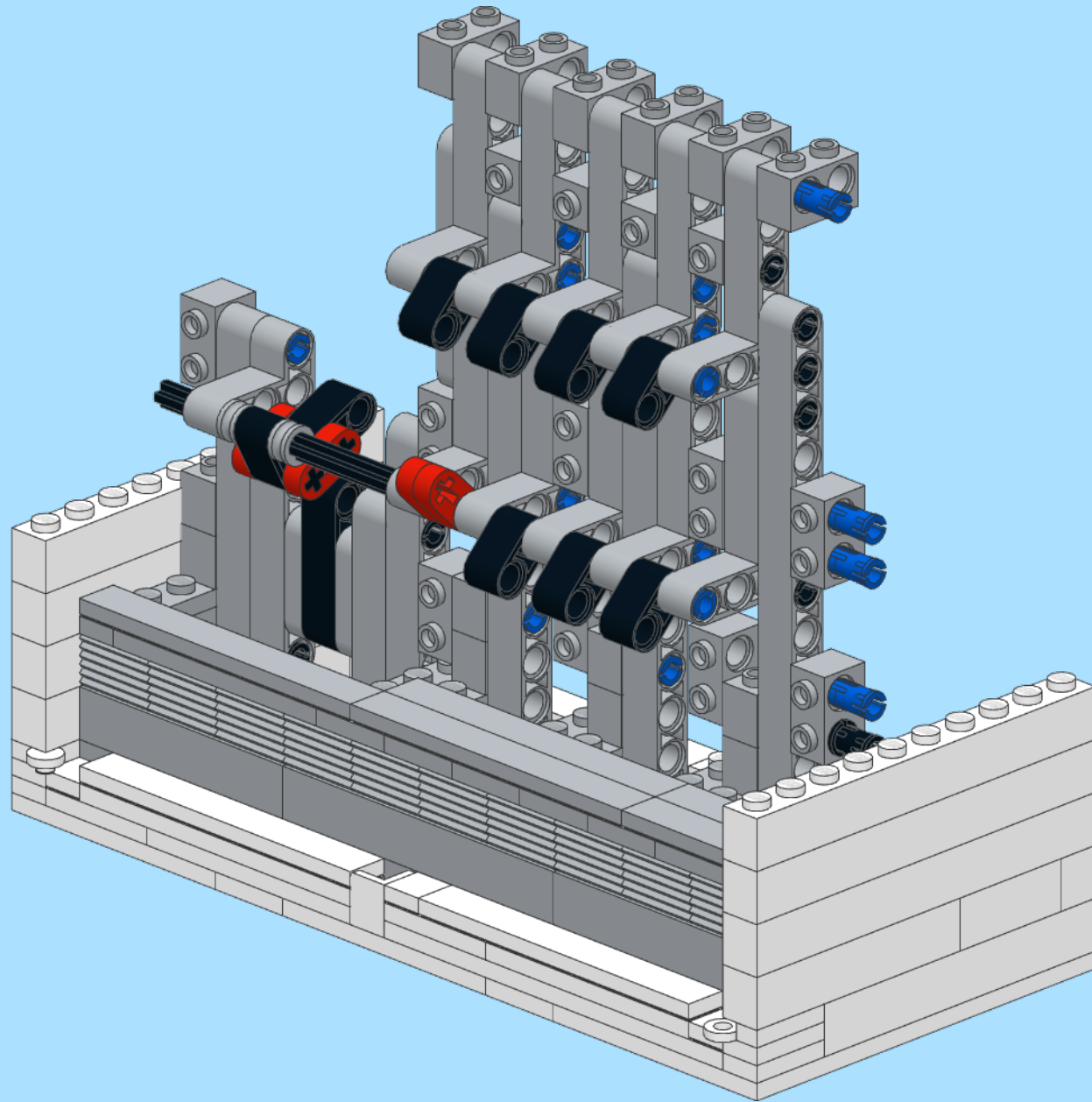
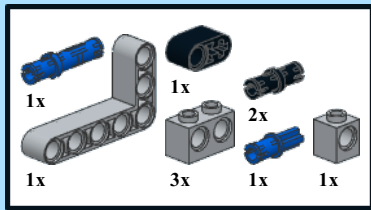



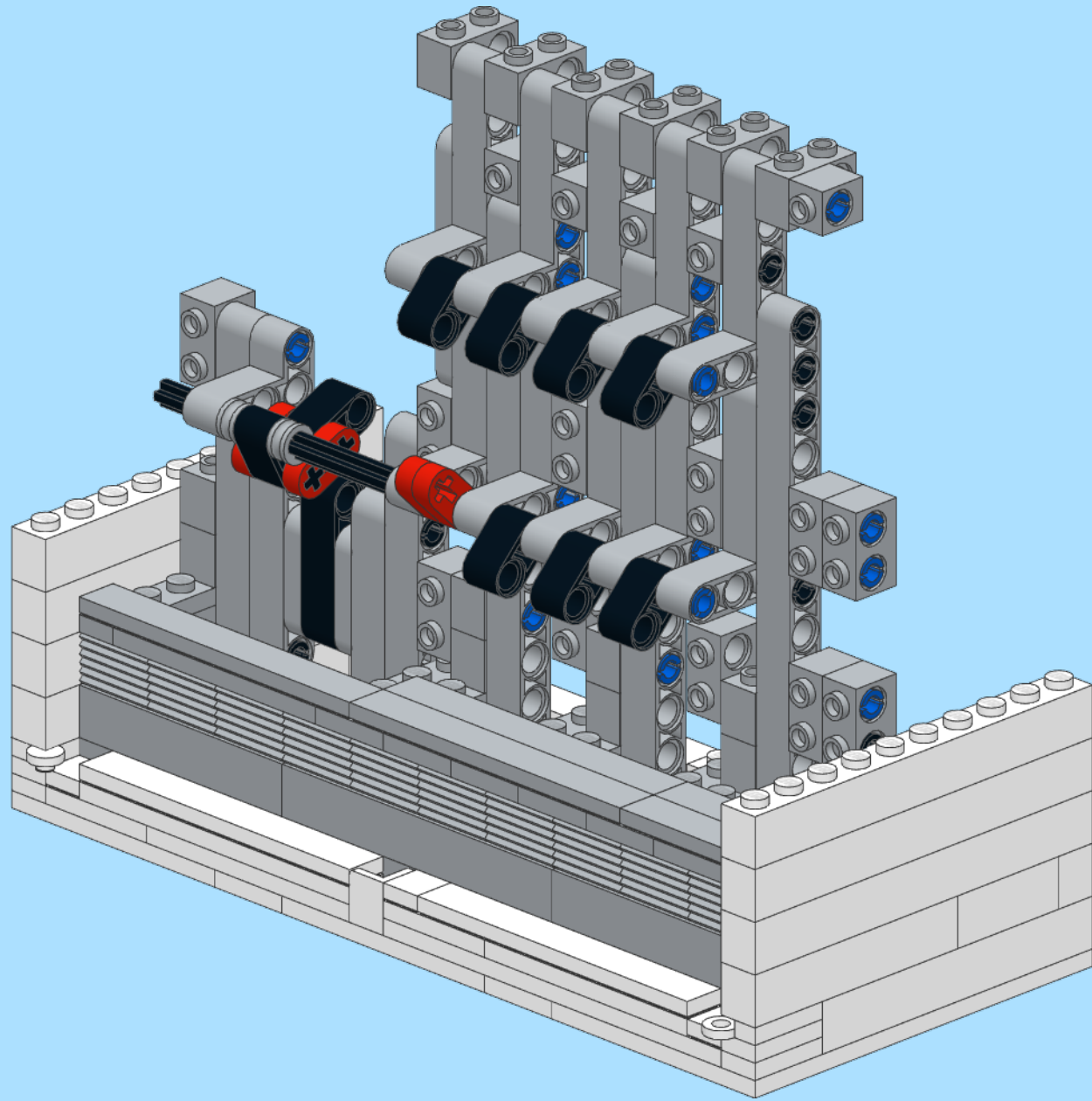
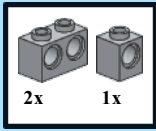

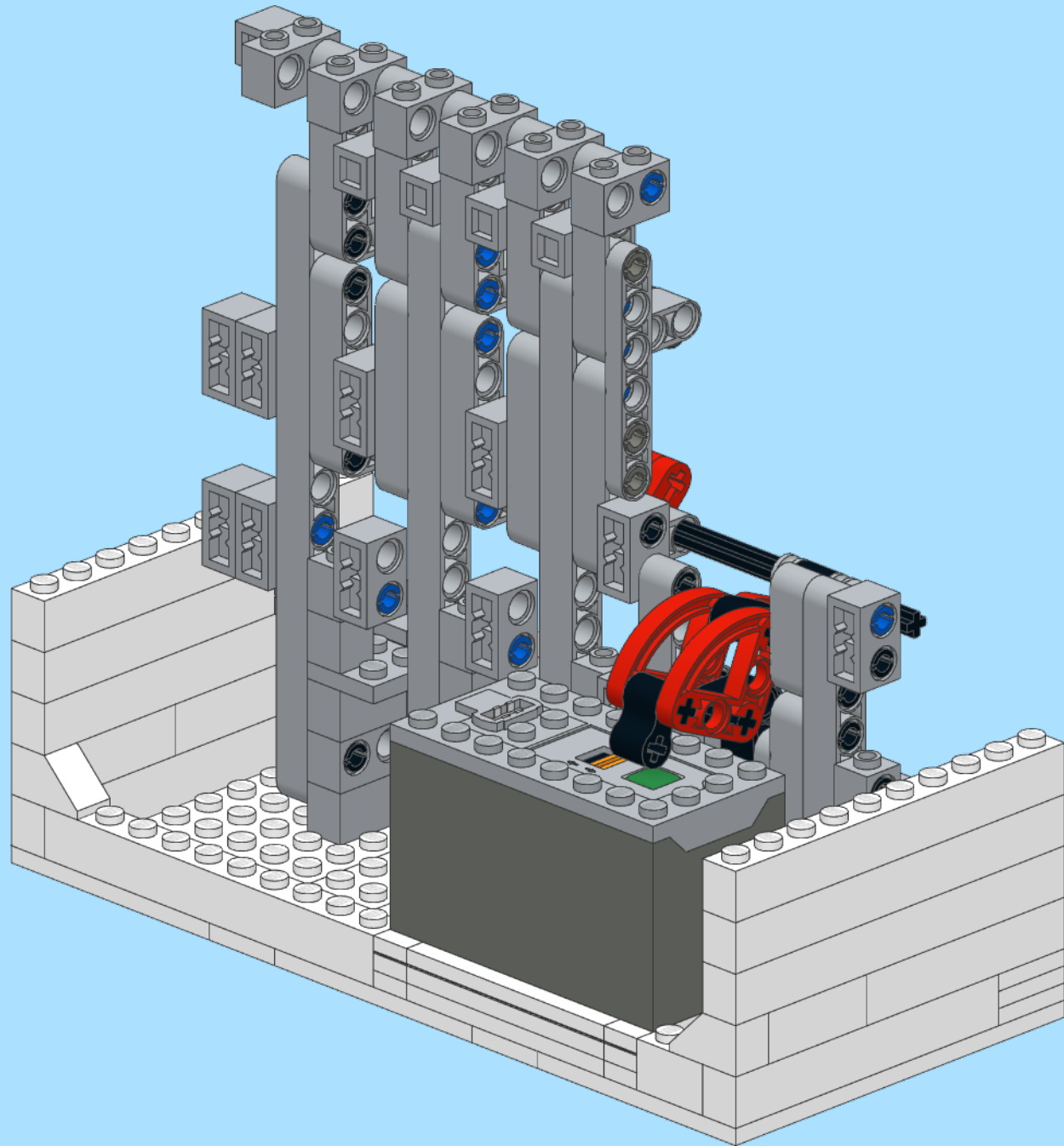
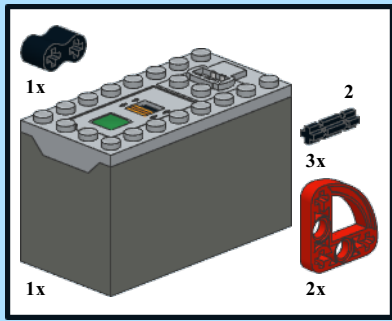

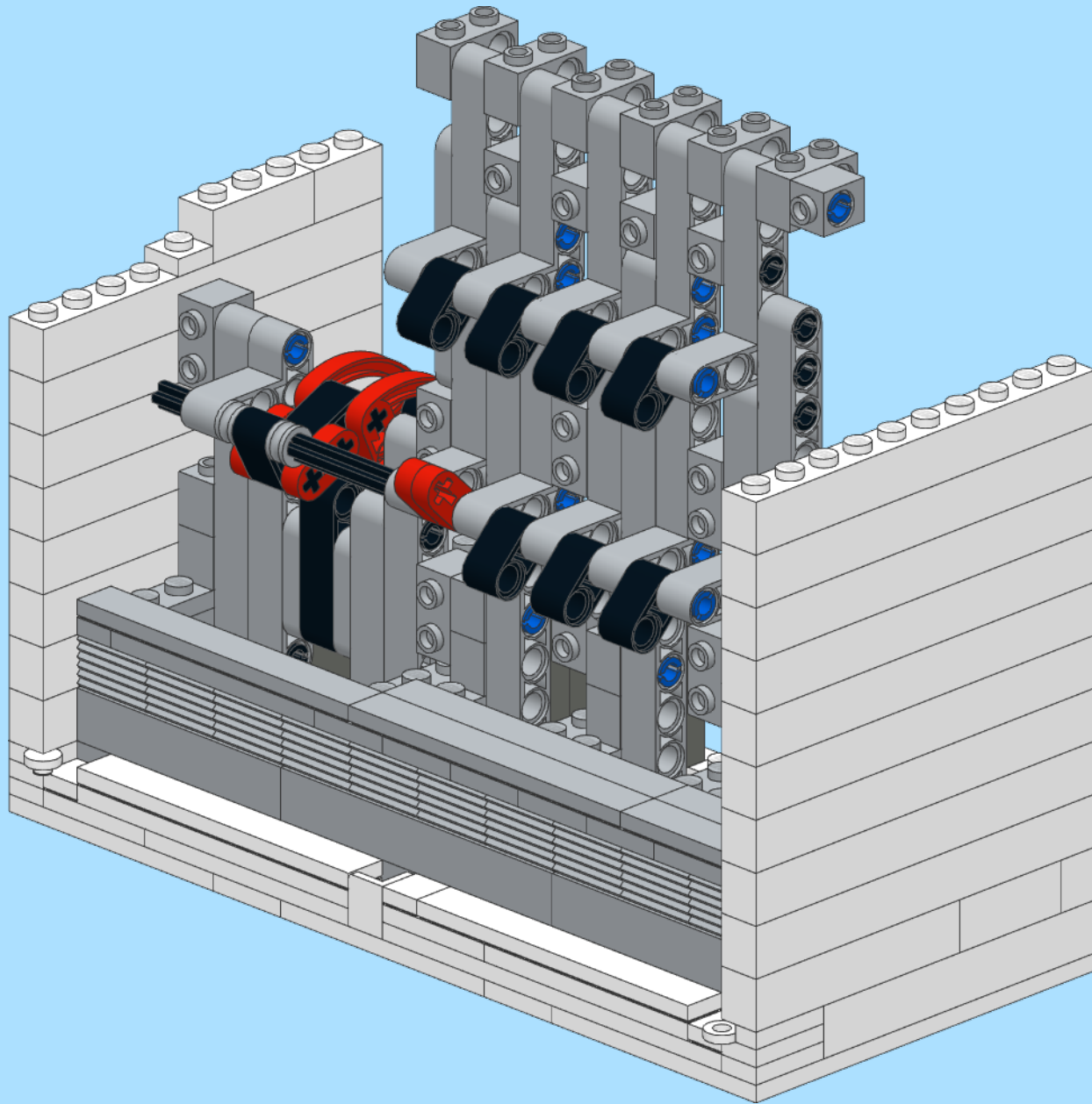
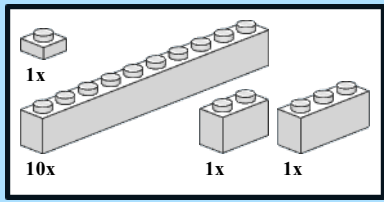



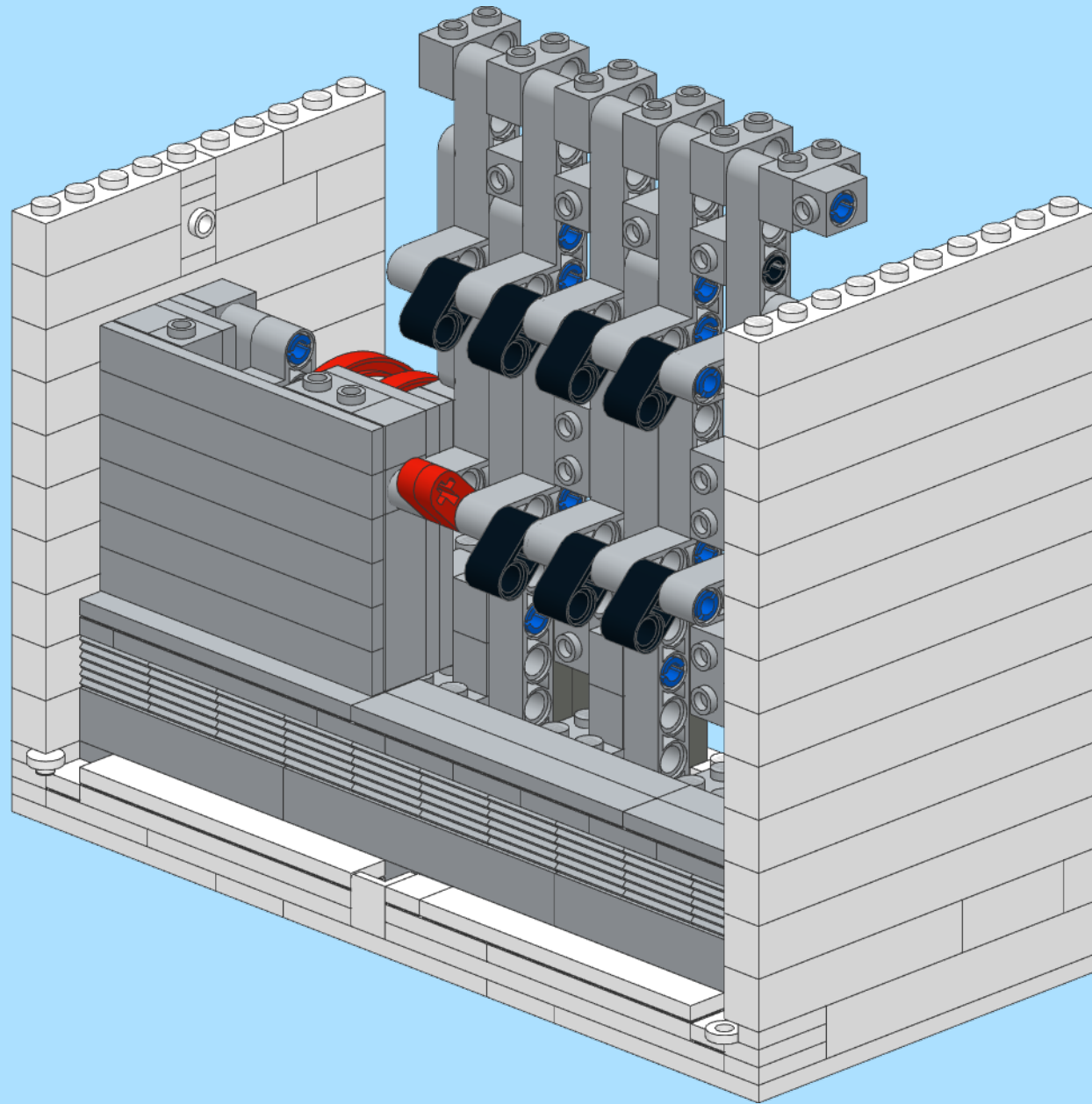
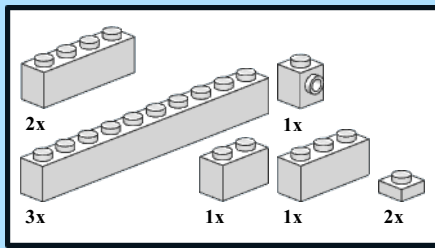

1

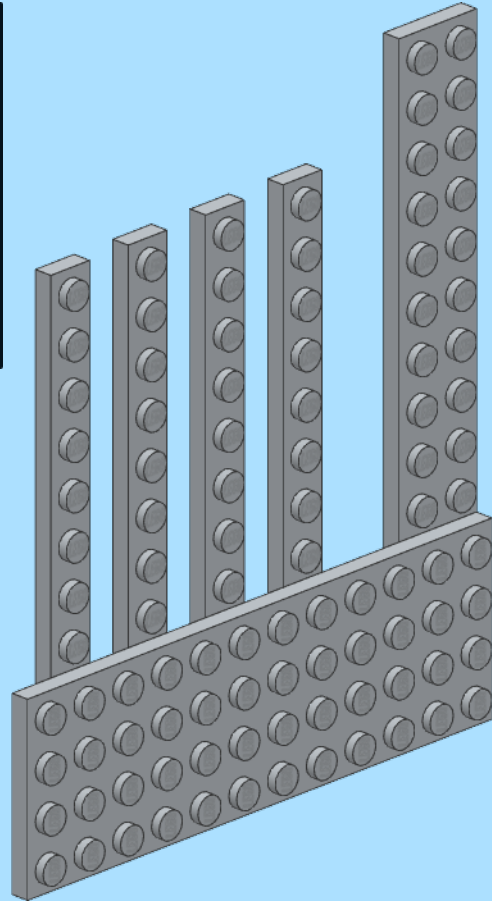
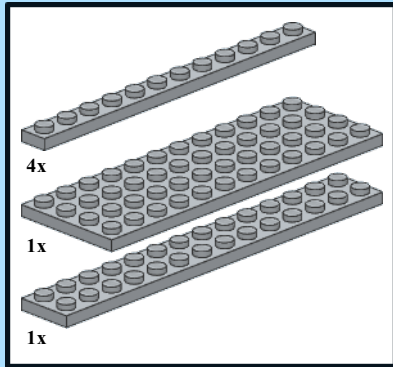

2

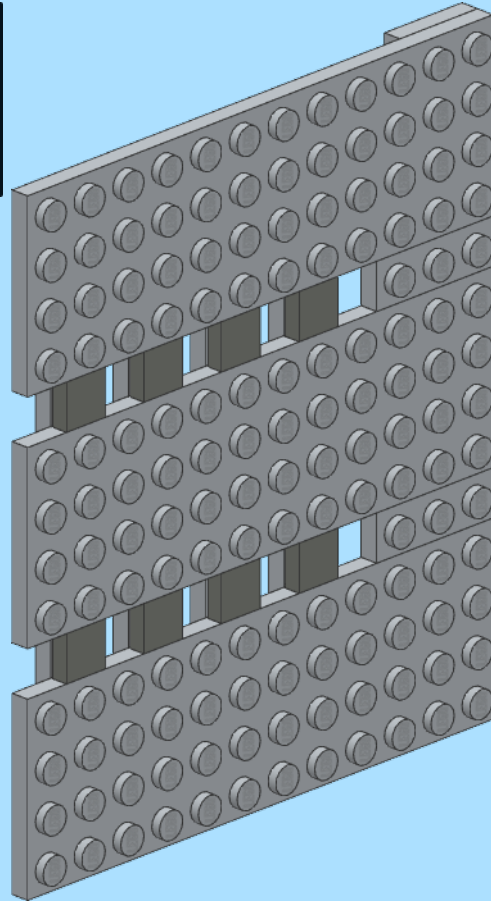
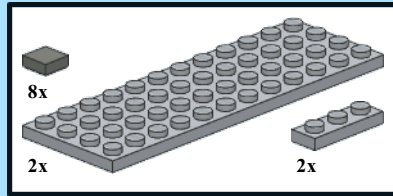

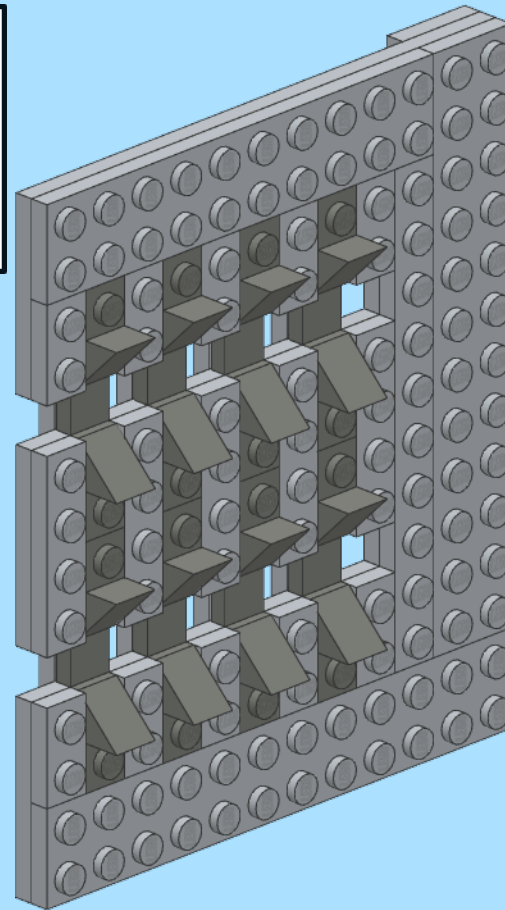
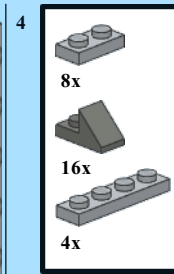
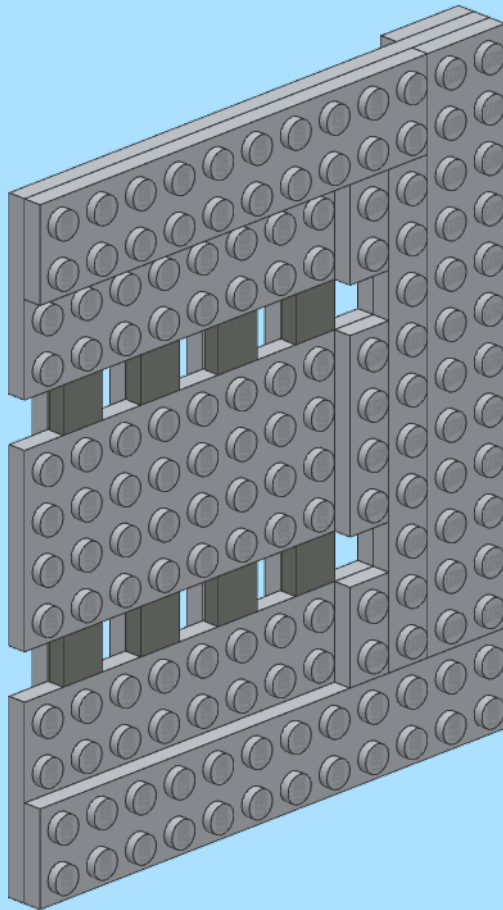
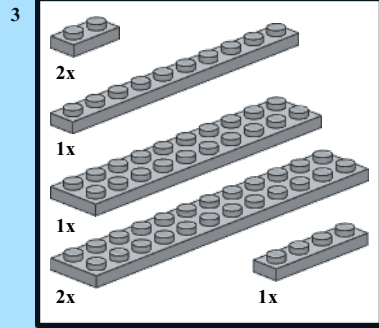

- 5
- 8x
  - 4x

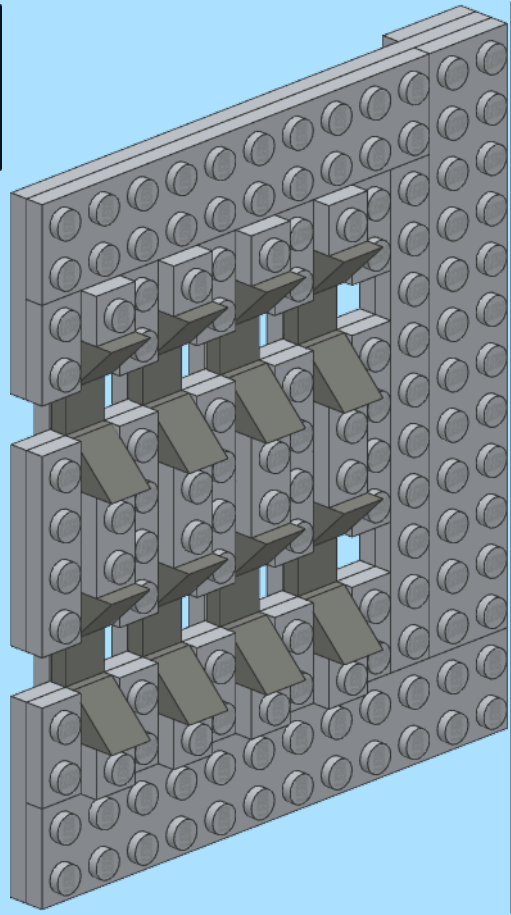

- 6
- 8x
  - 10x
  - 10x
  - 5x
  - 8x
  - 8x

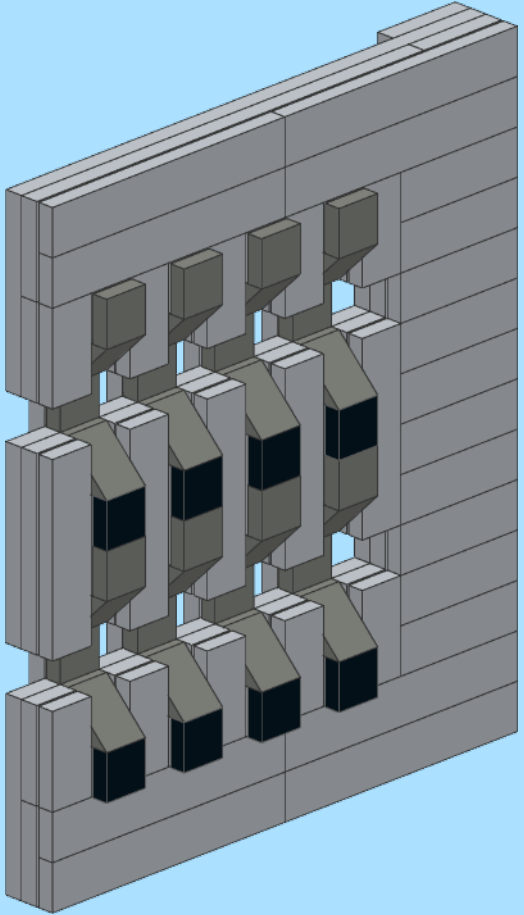



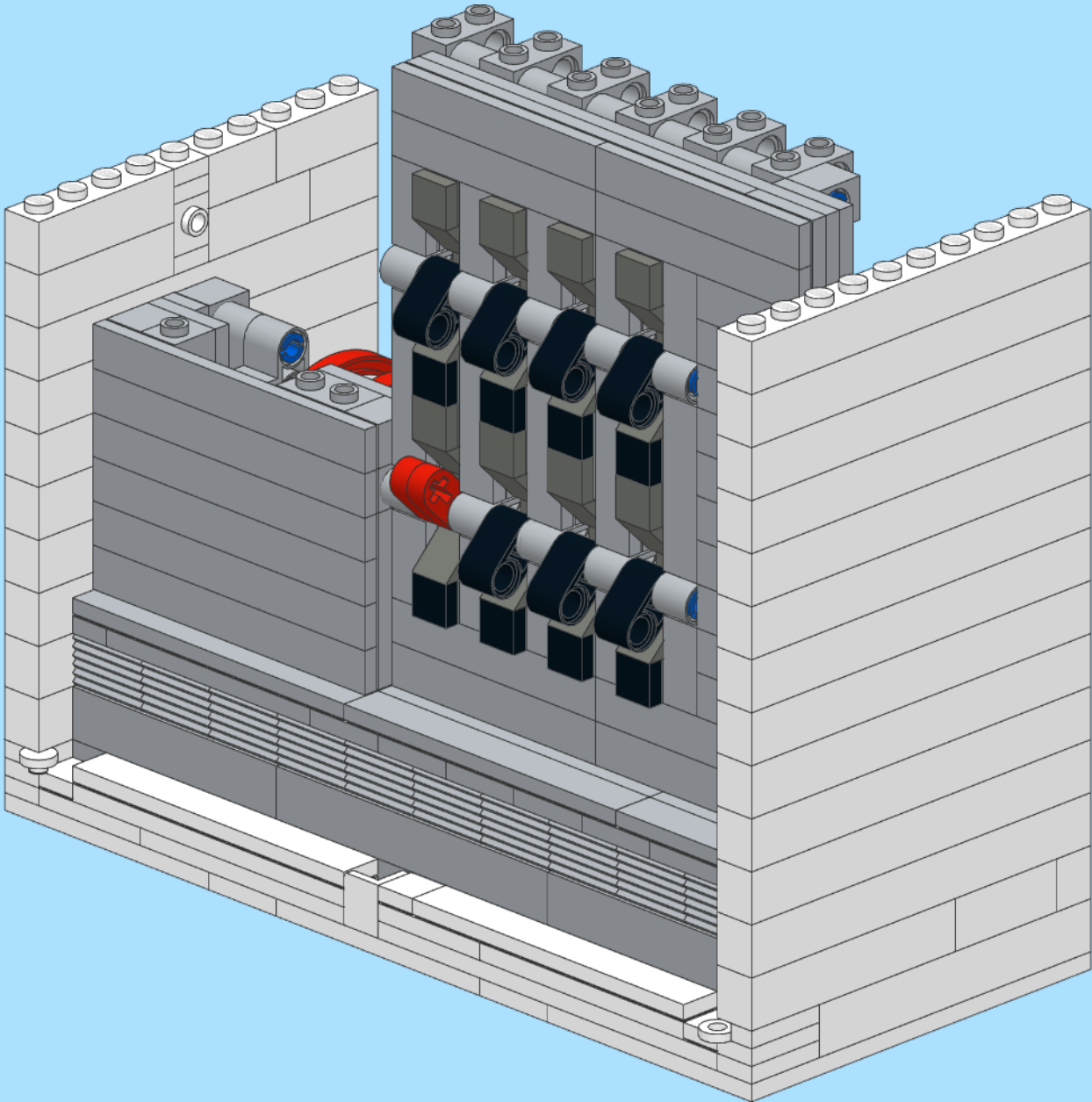

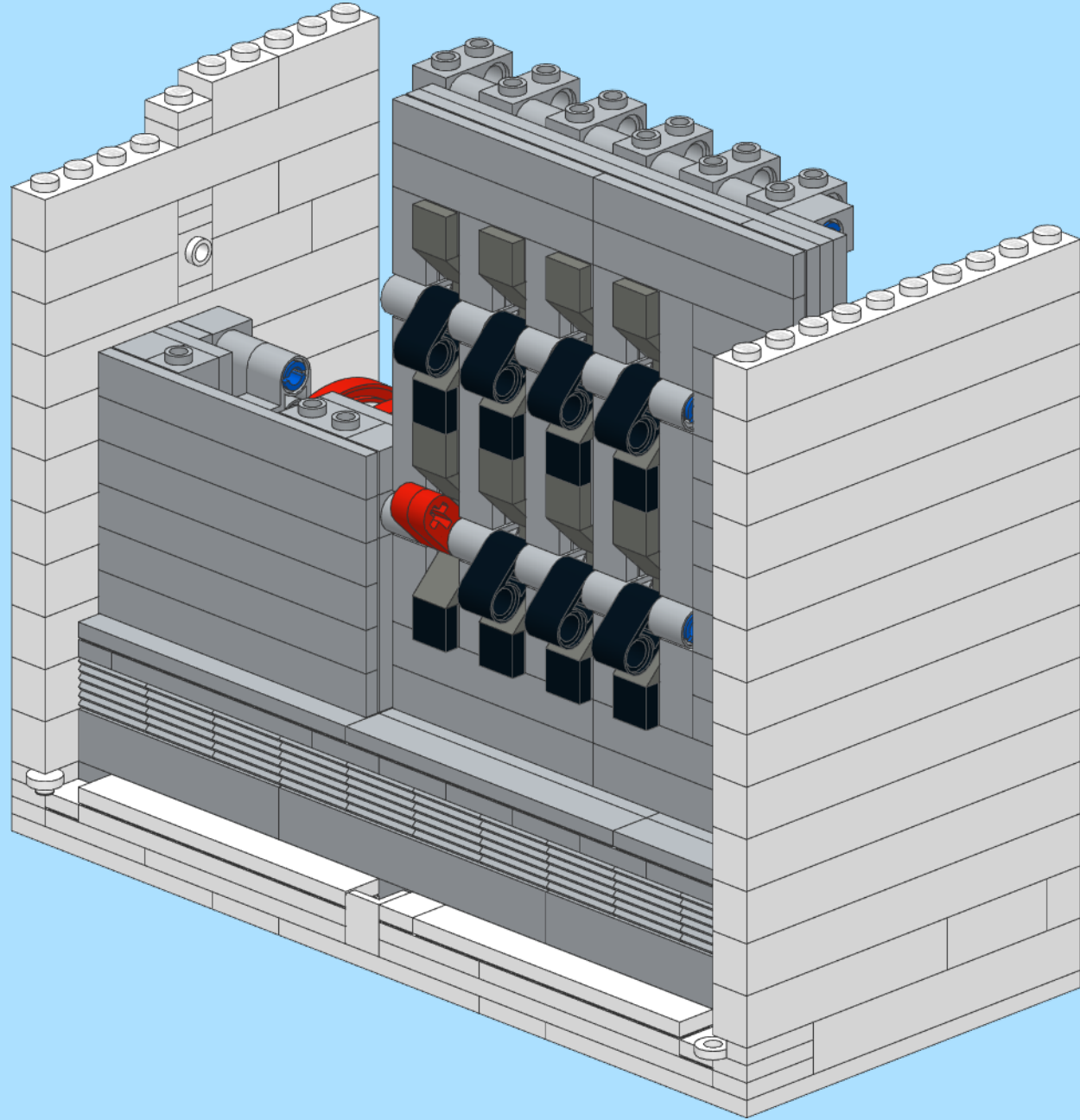
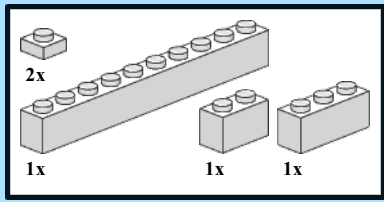

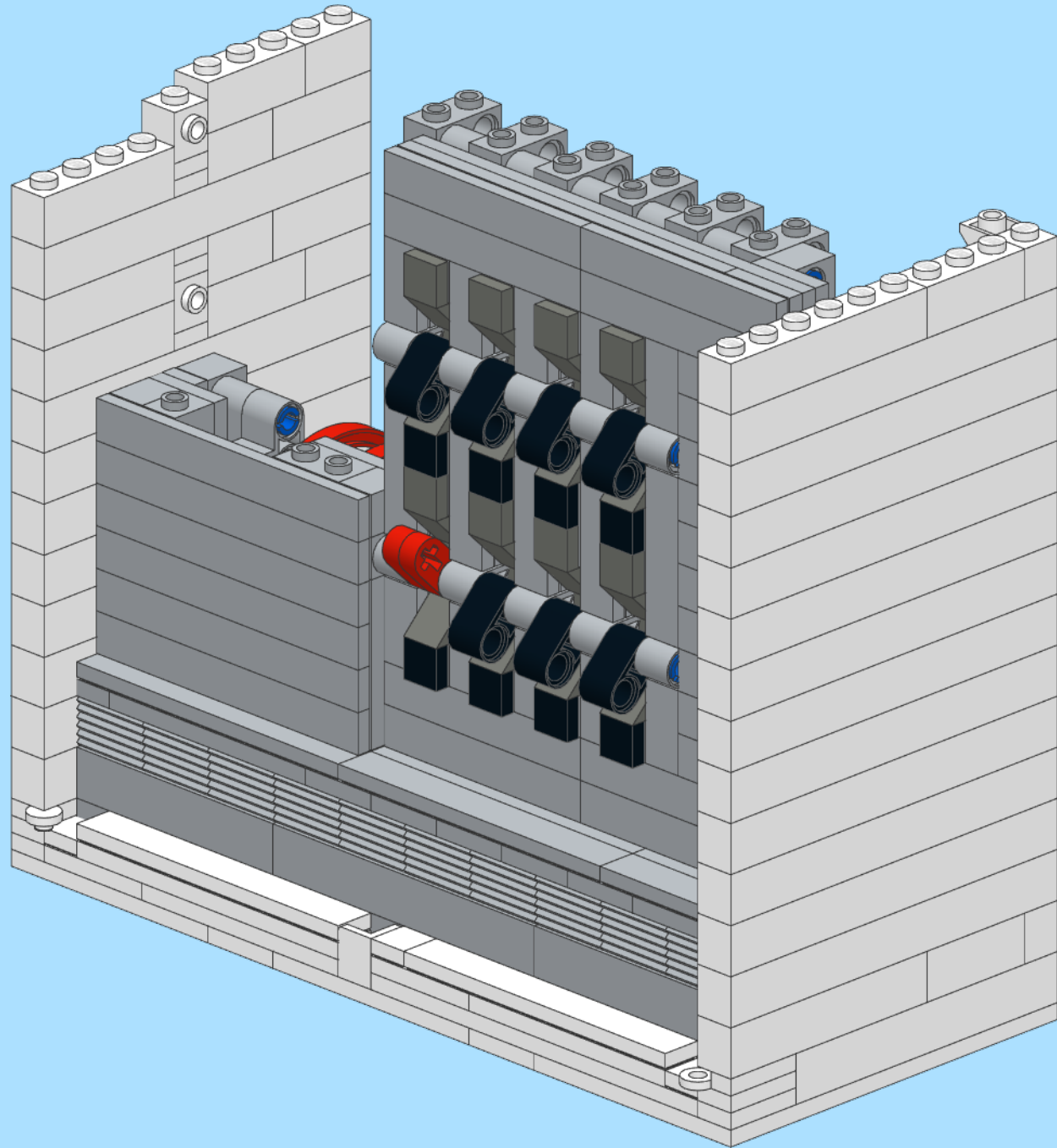
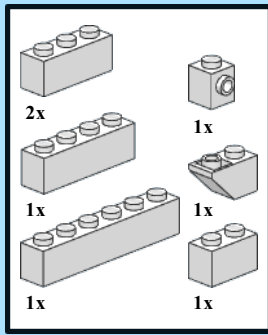

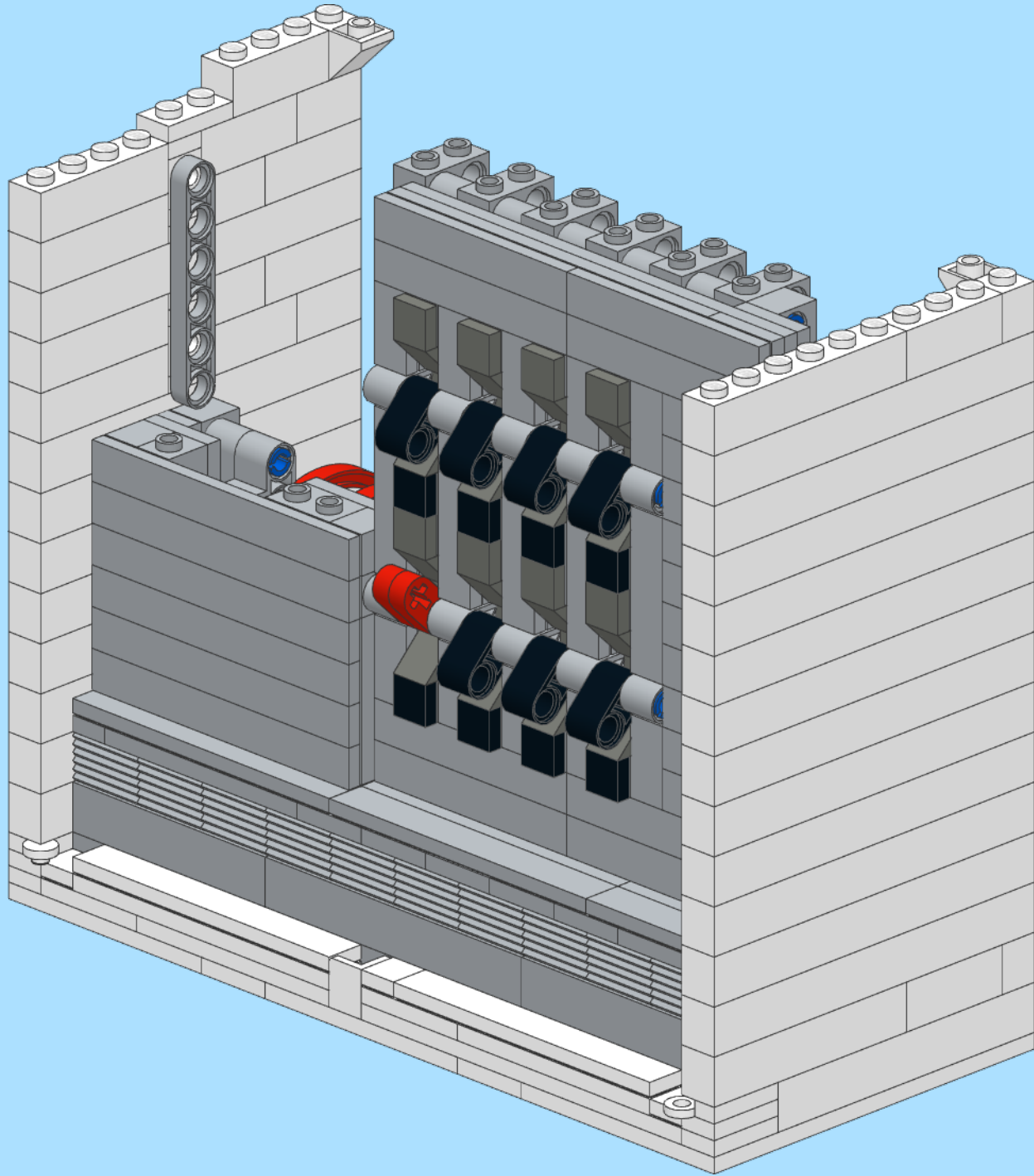
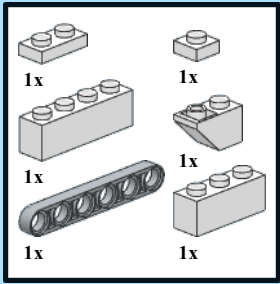

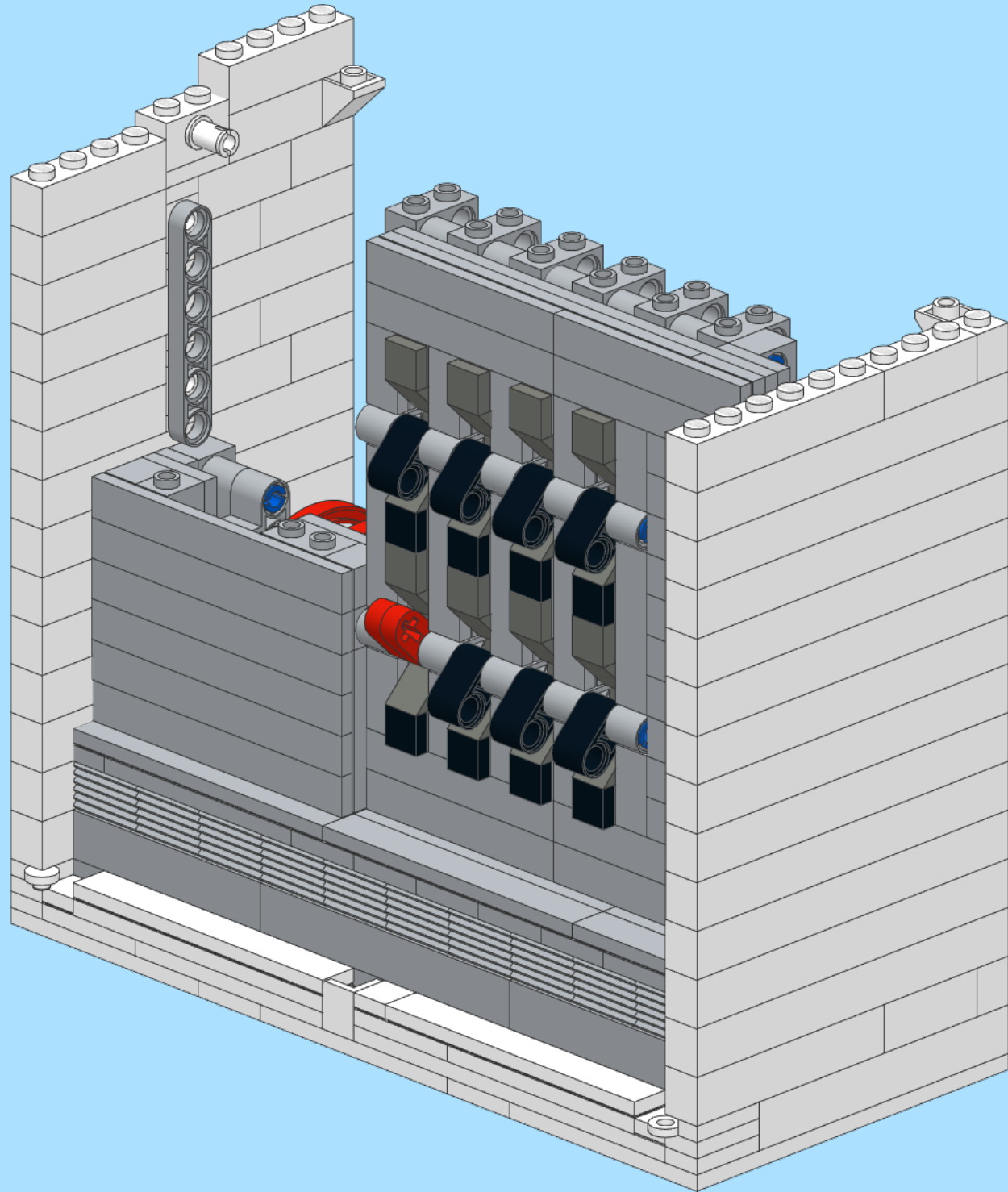
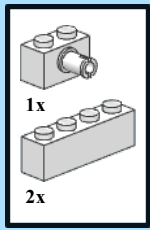

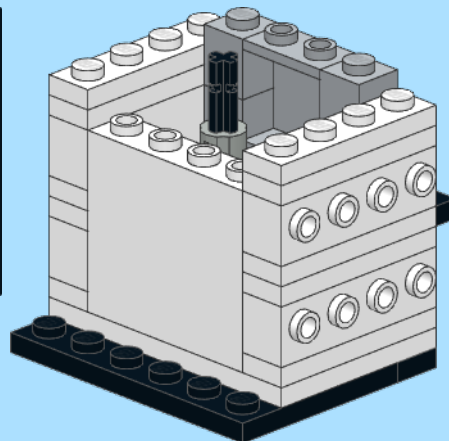
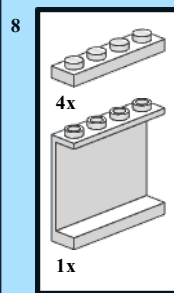
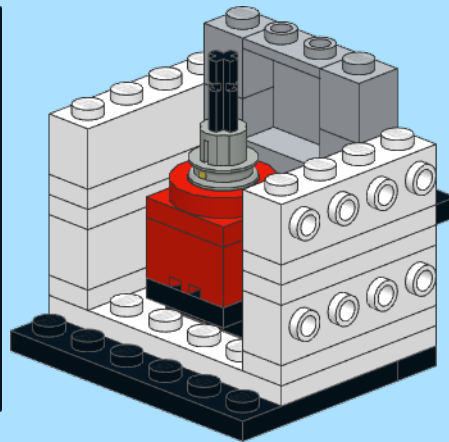
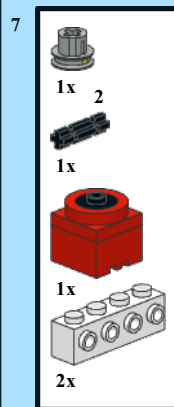
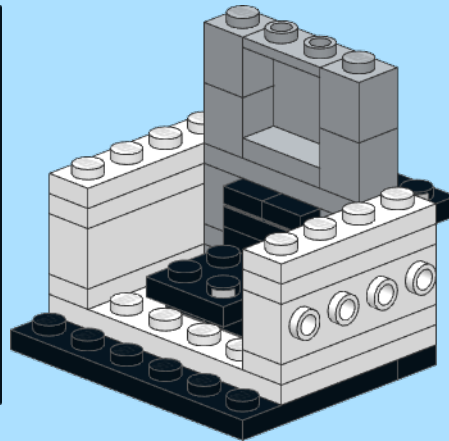
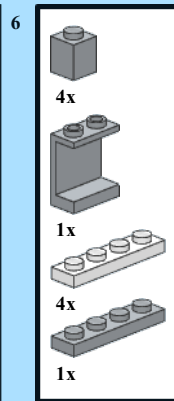
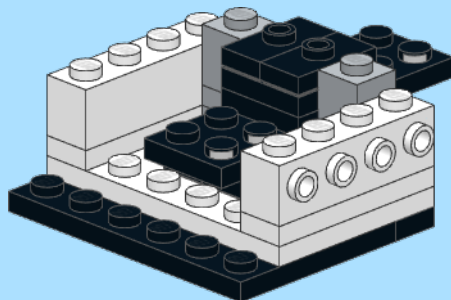
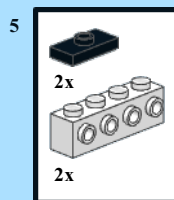
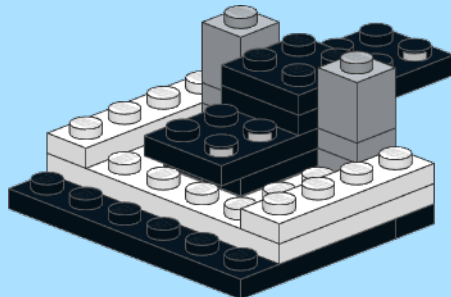
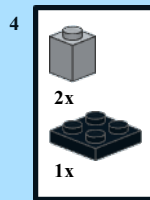
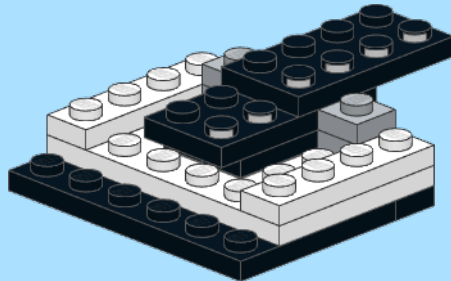
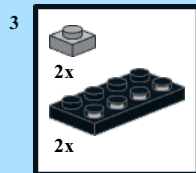
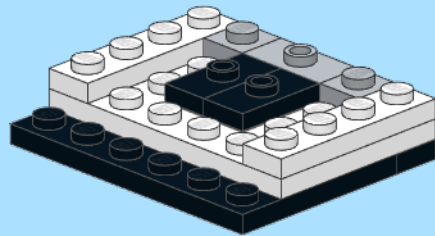
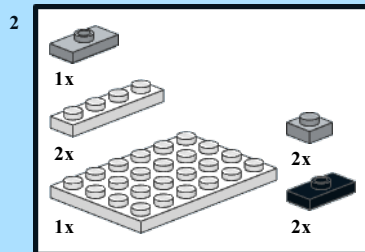
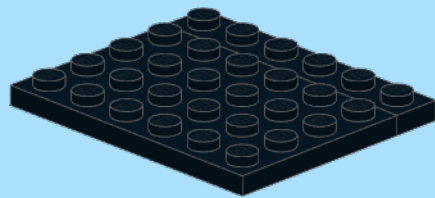
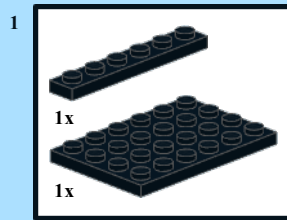

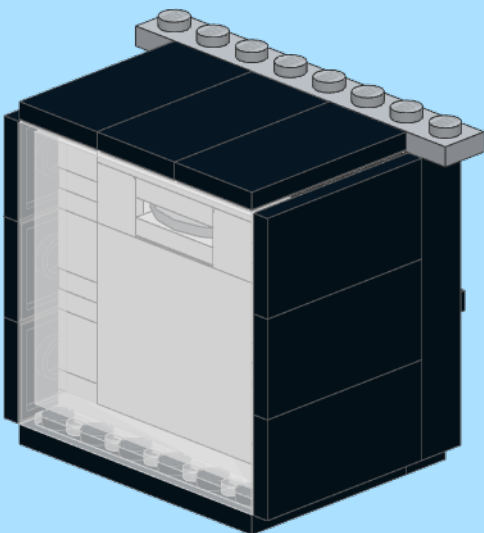
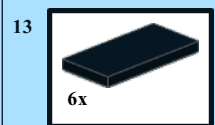
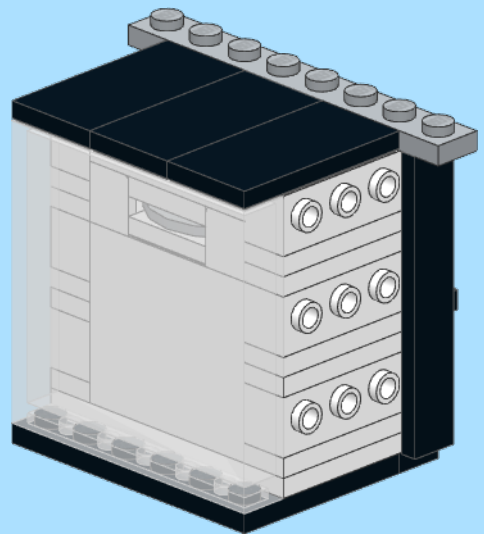
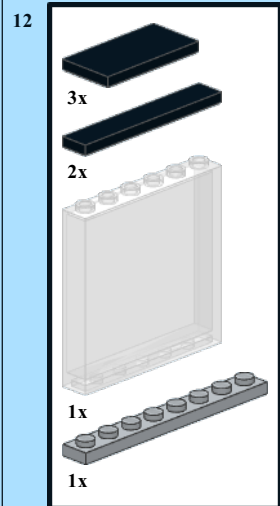
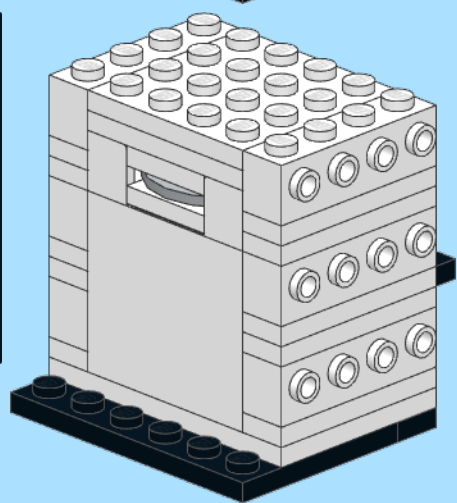
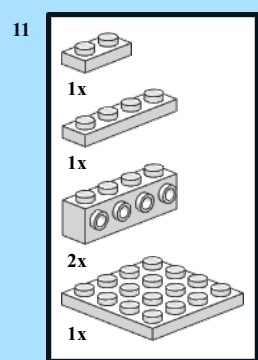
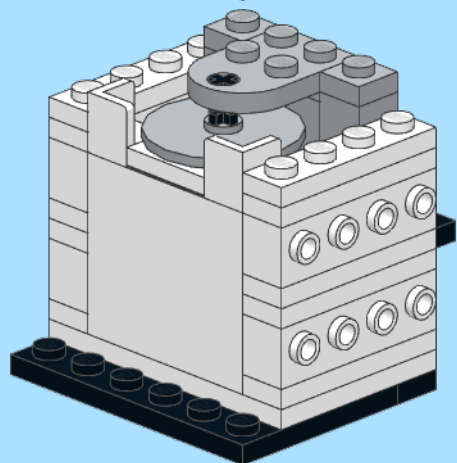
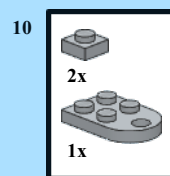
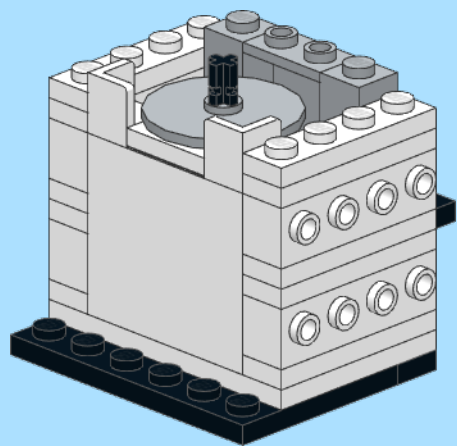
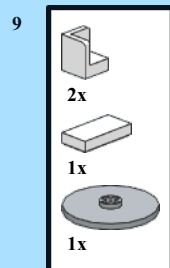

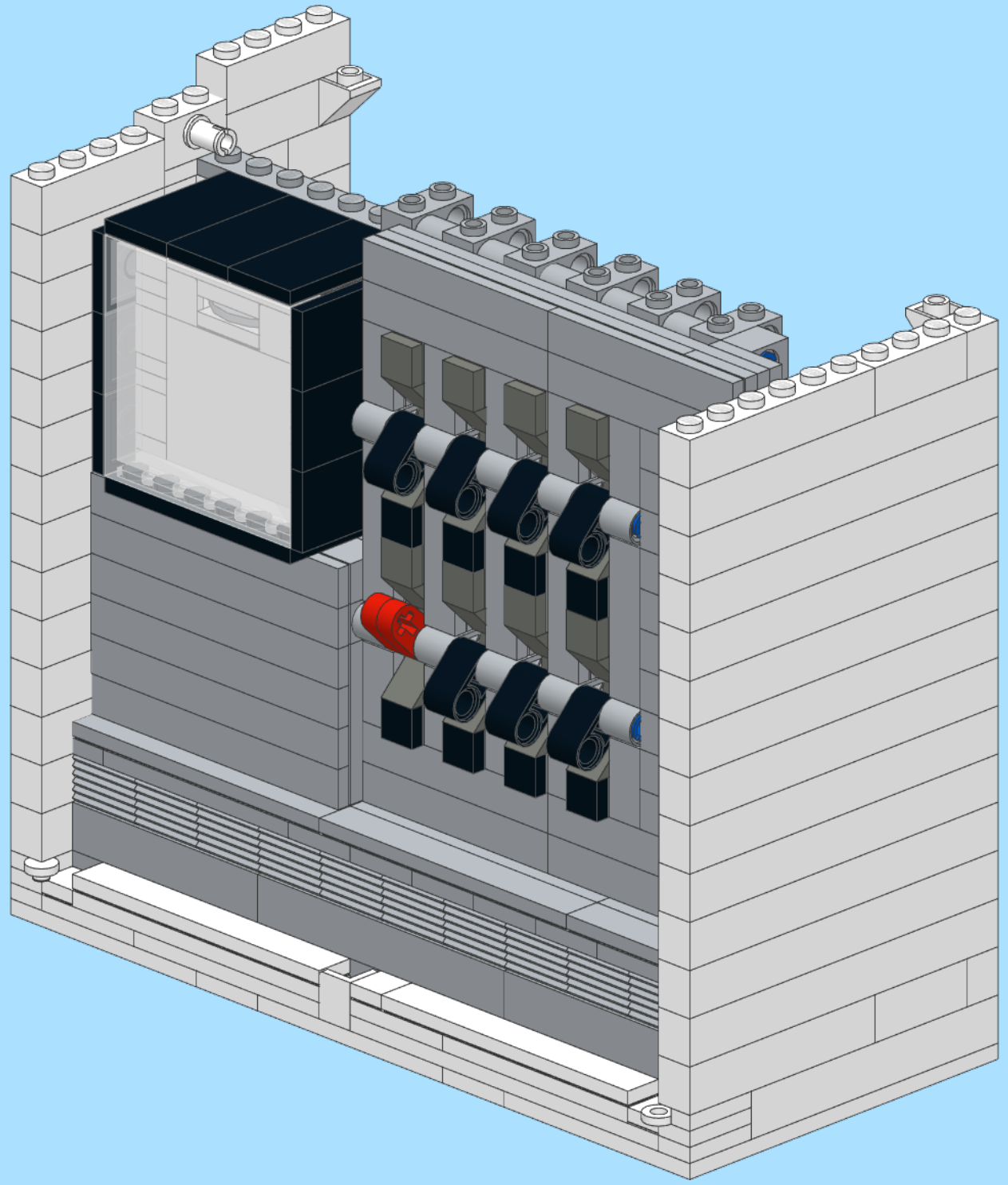



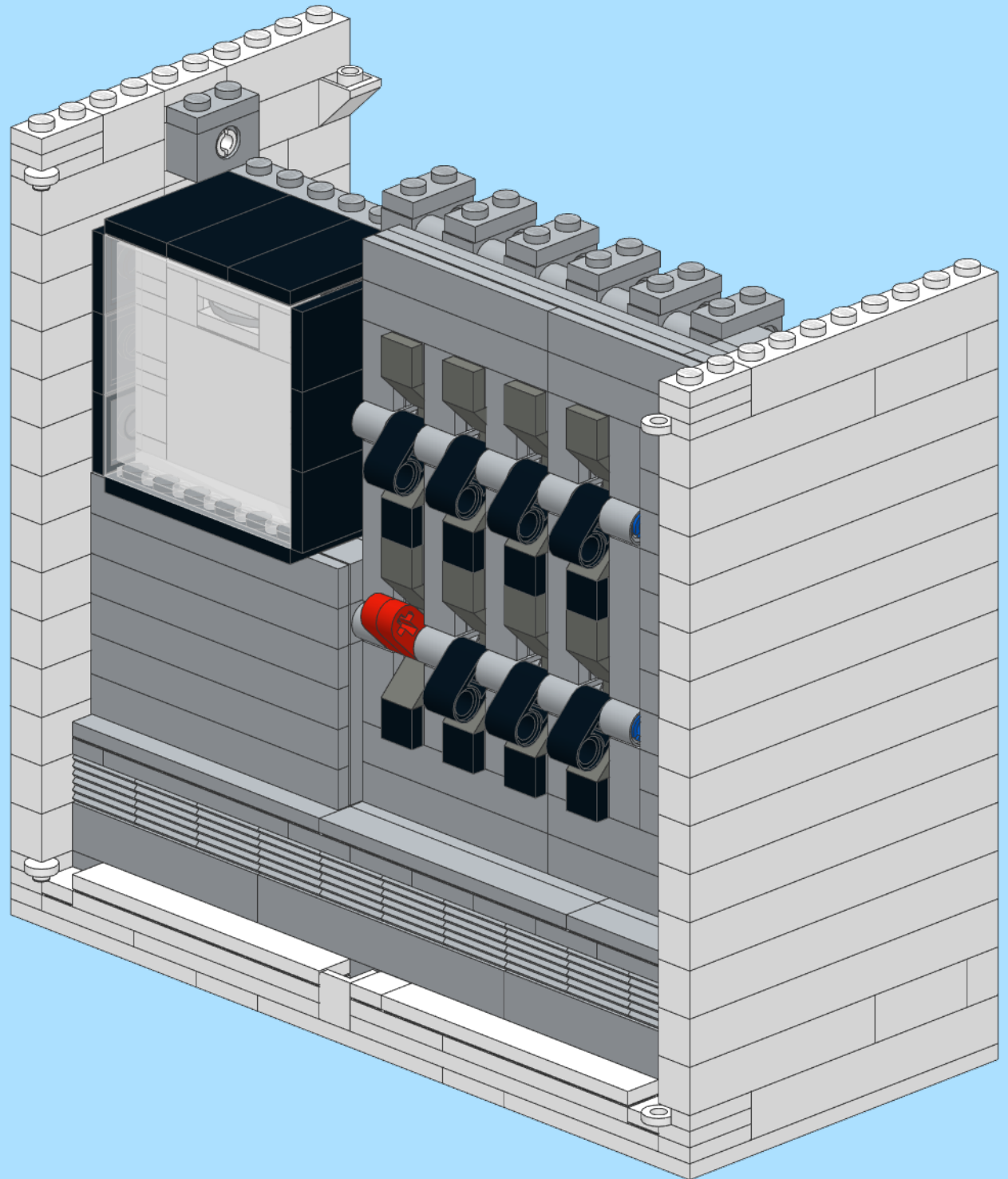
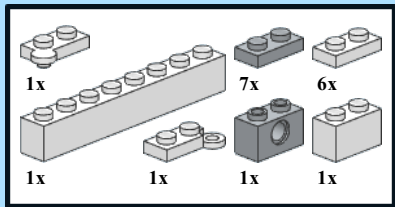

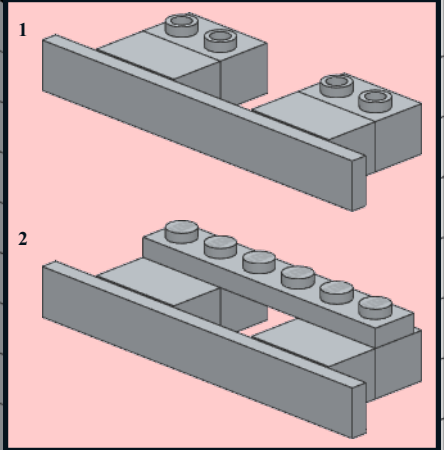
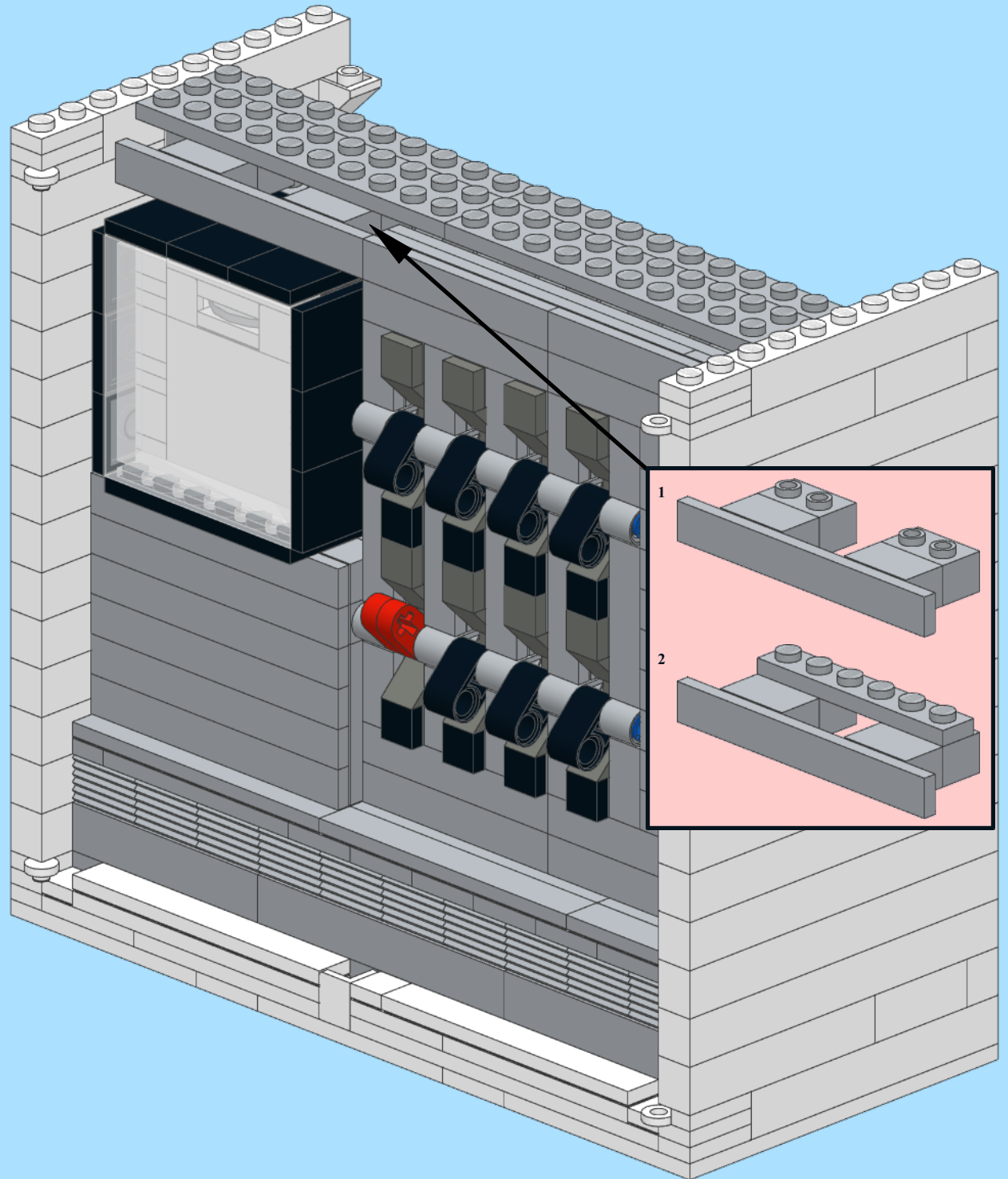
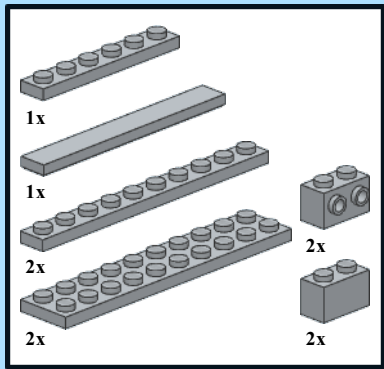

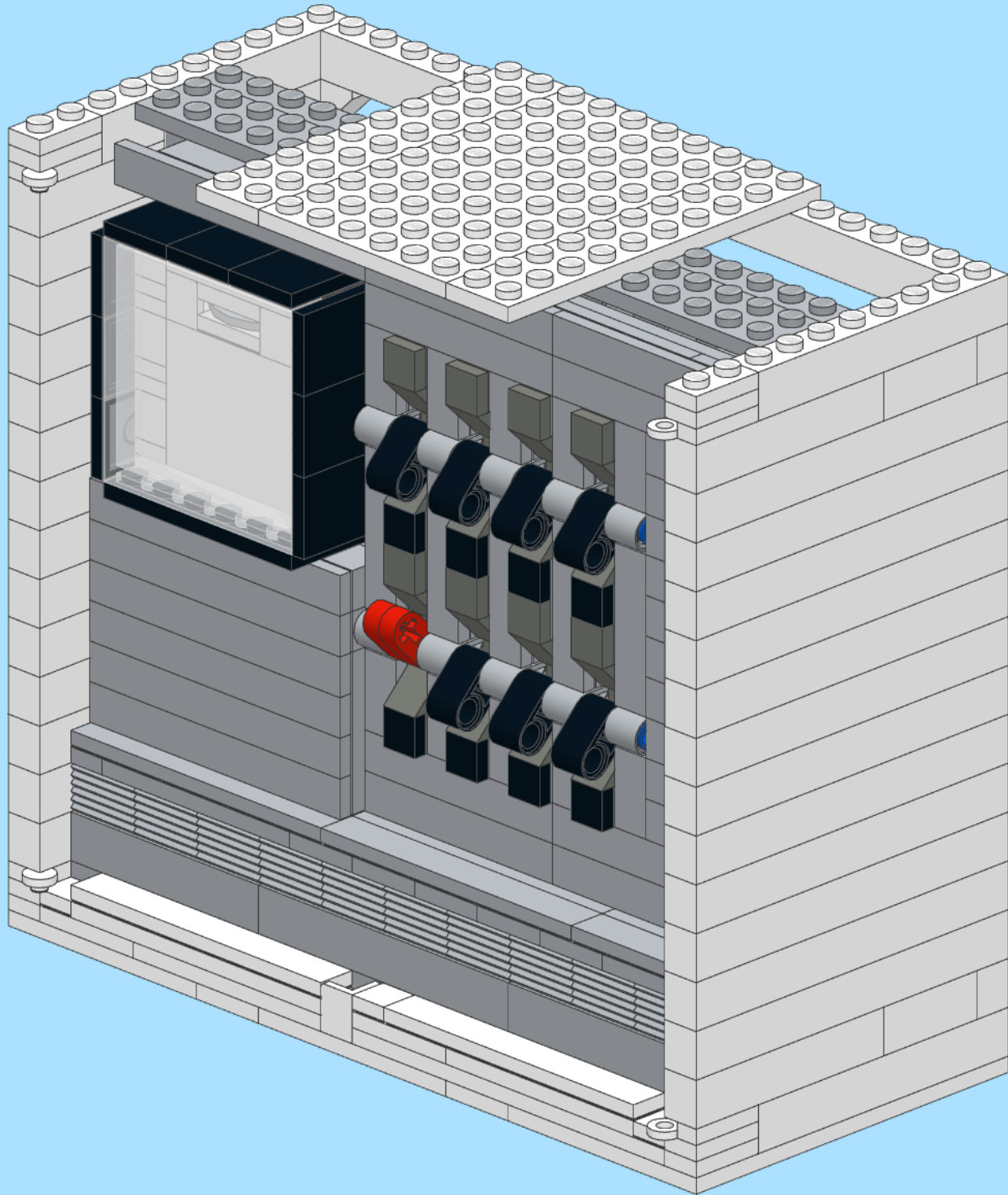
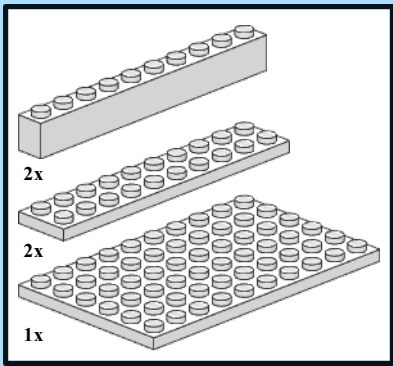

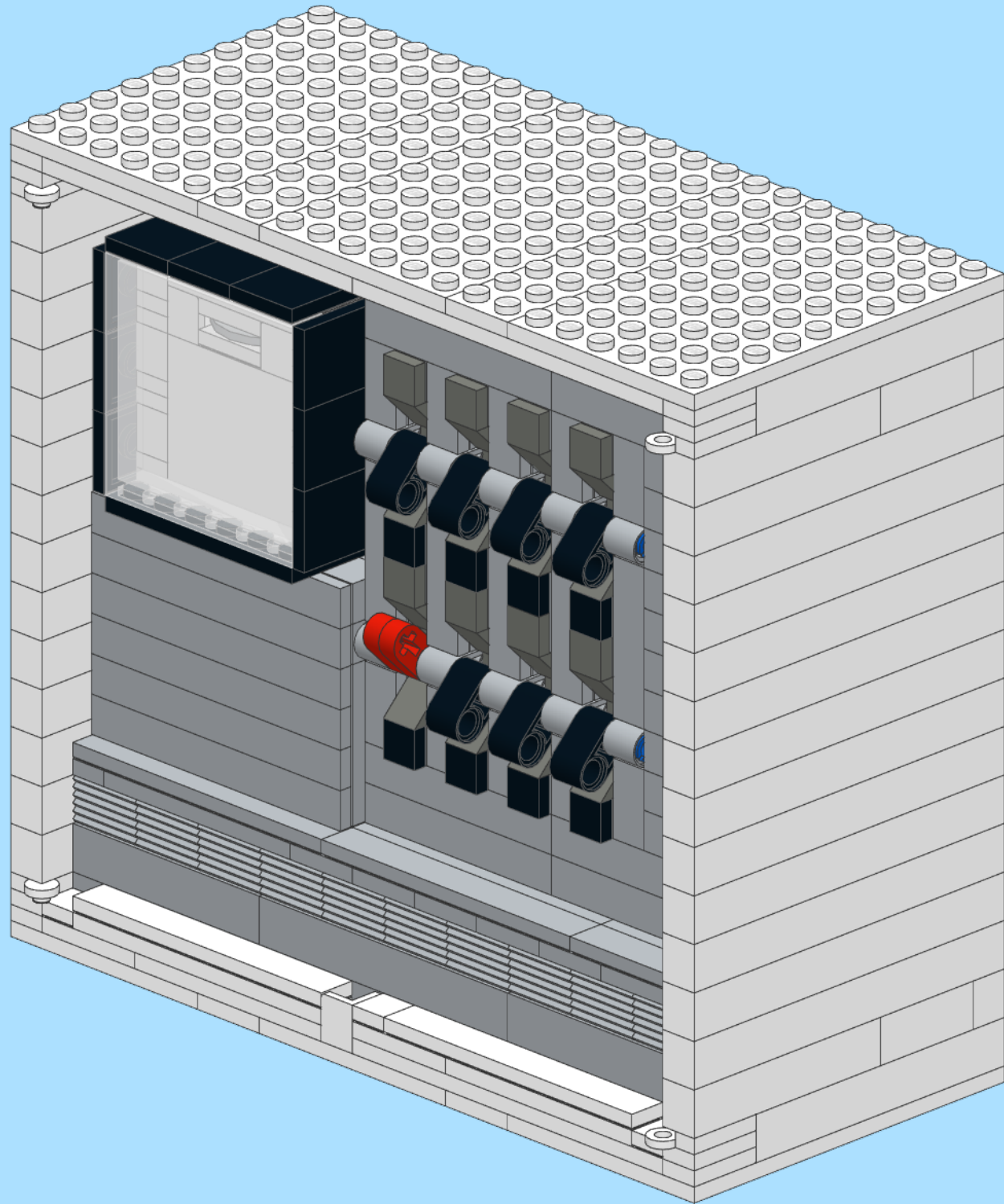
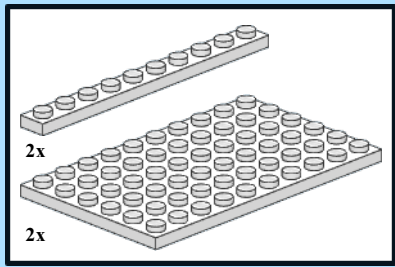

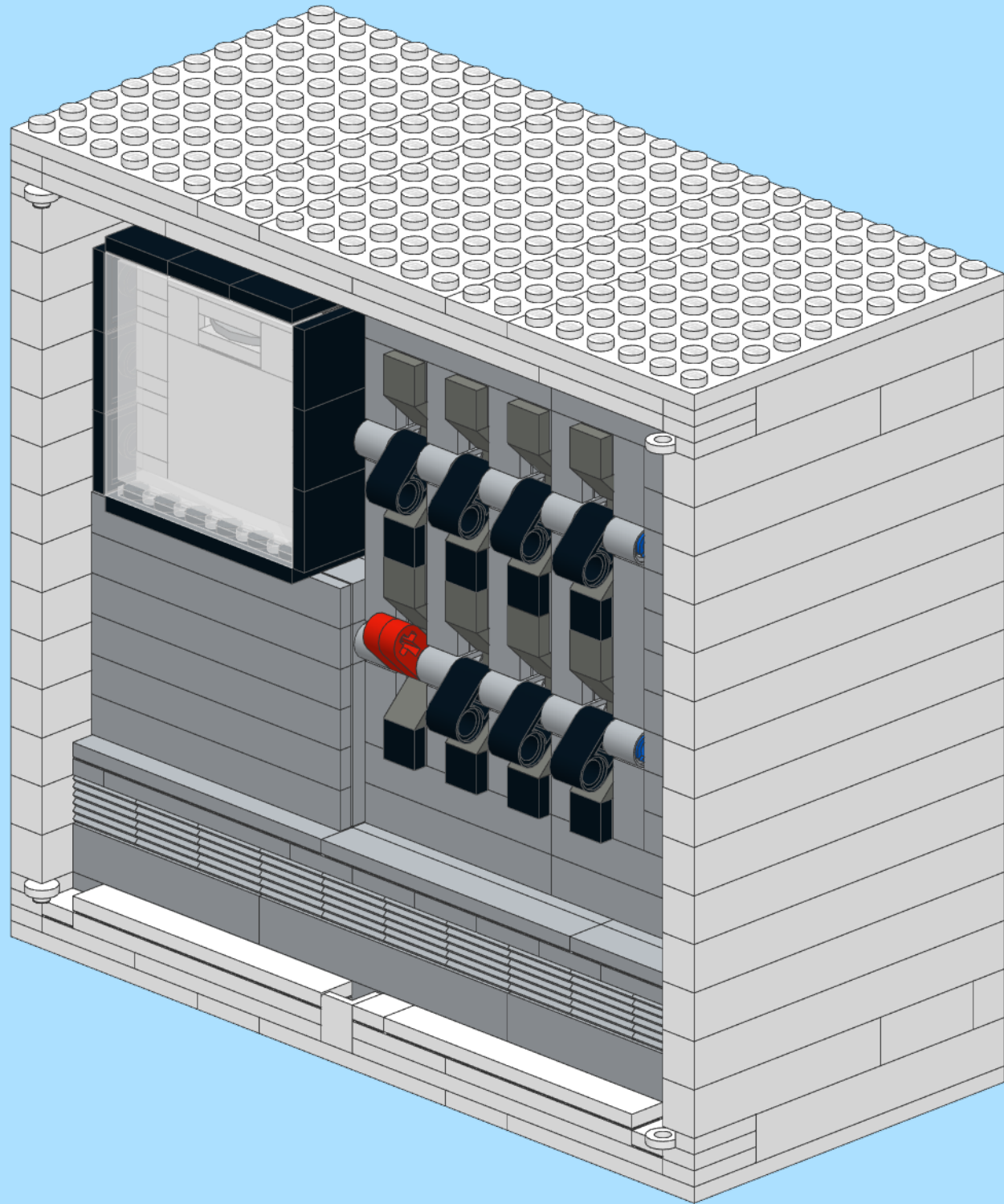
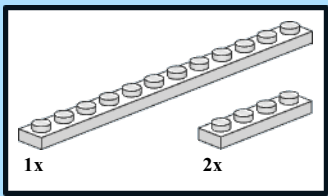

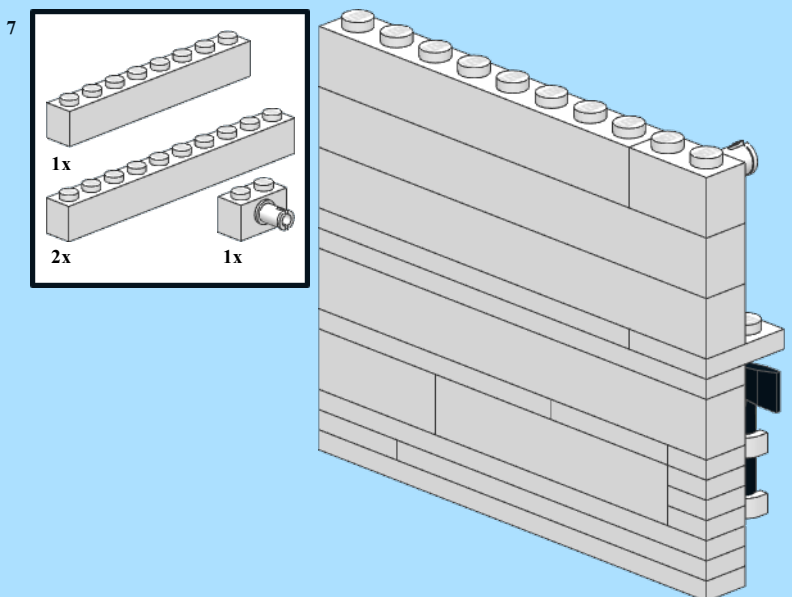
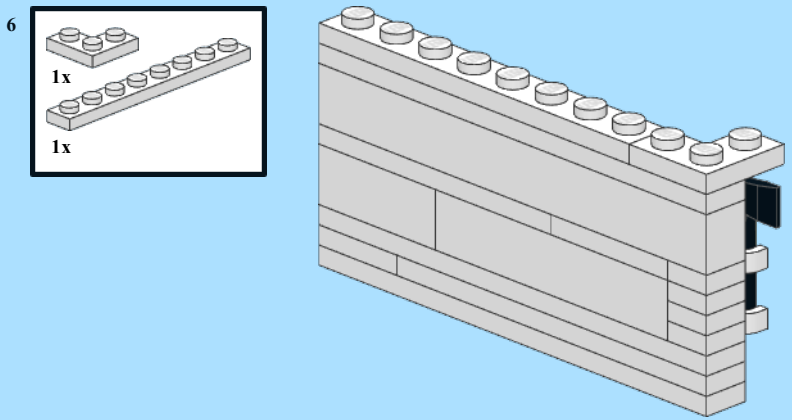
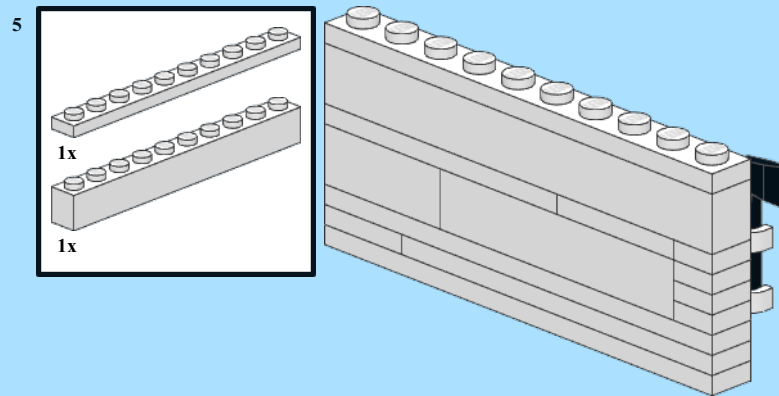
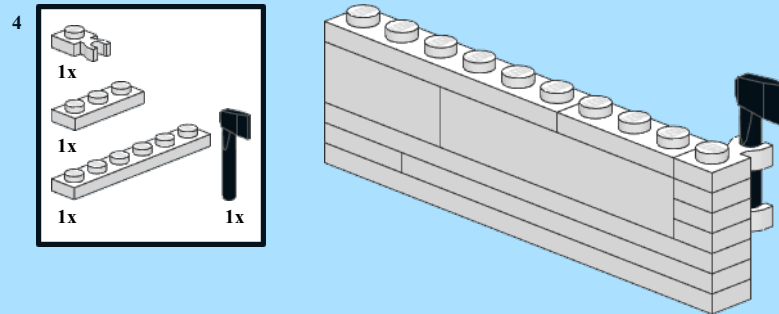
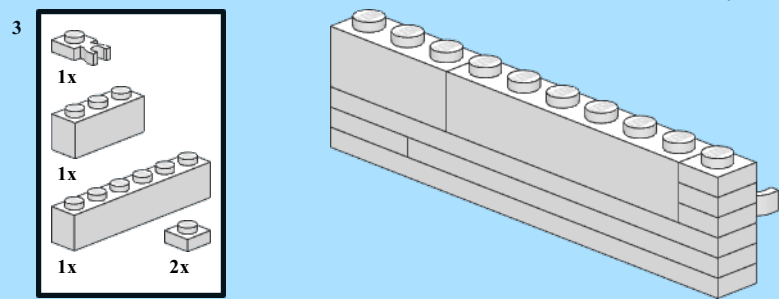
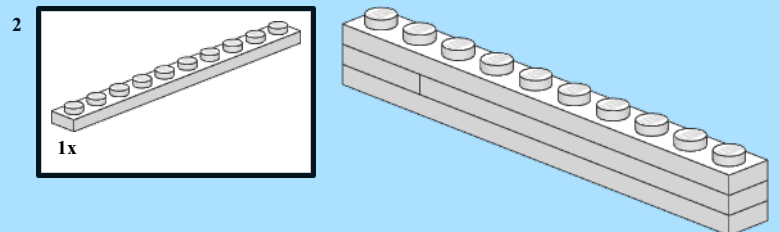
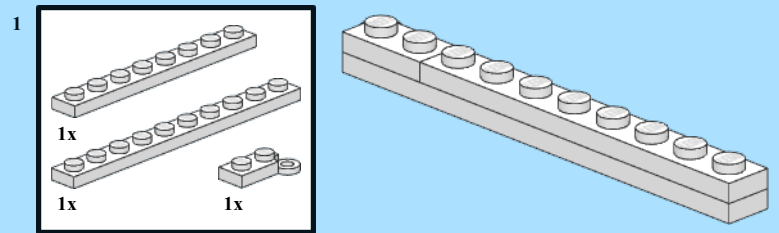

8

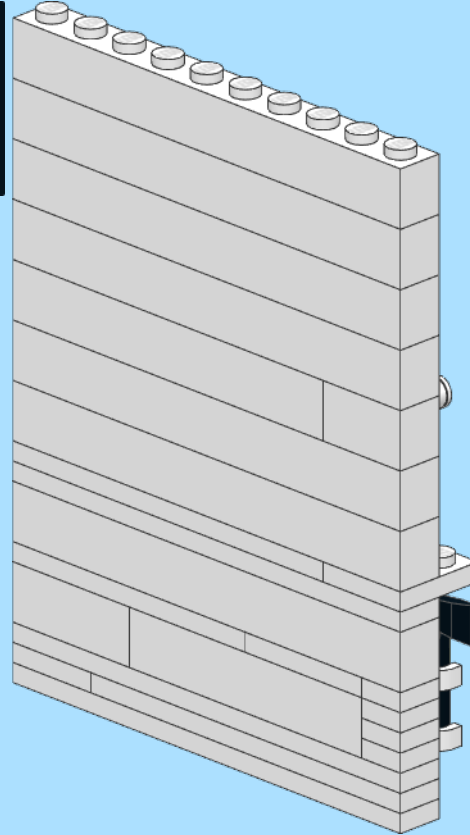
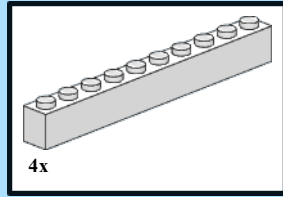

9

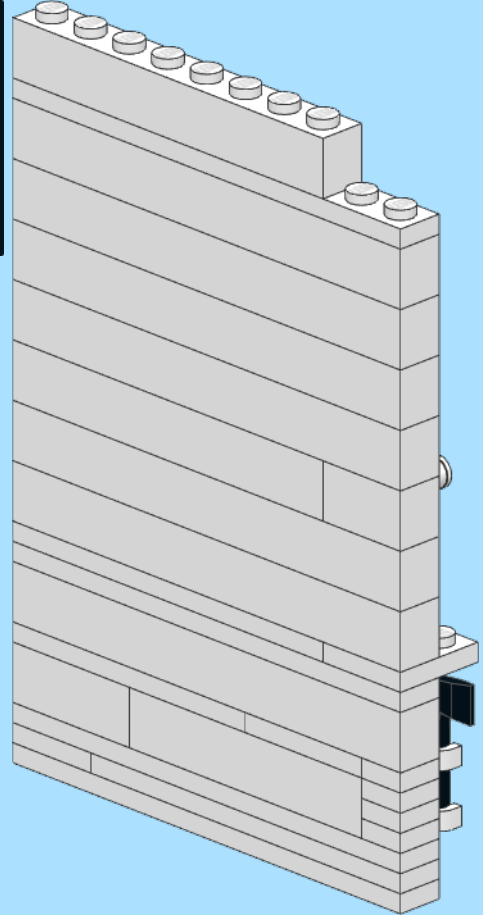
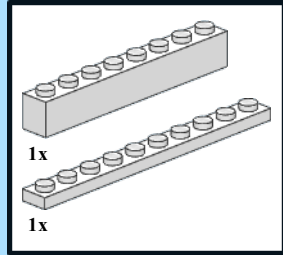

10

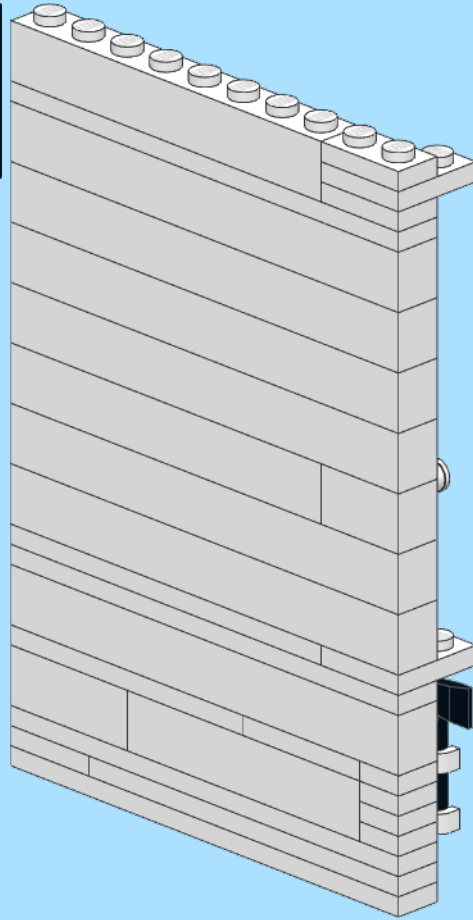
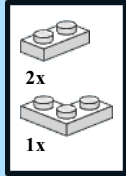

11

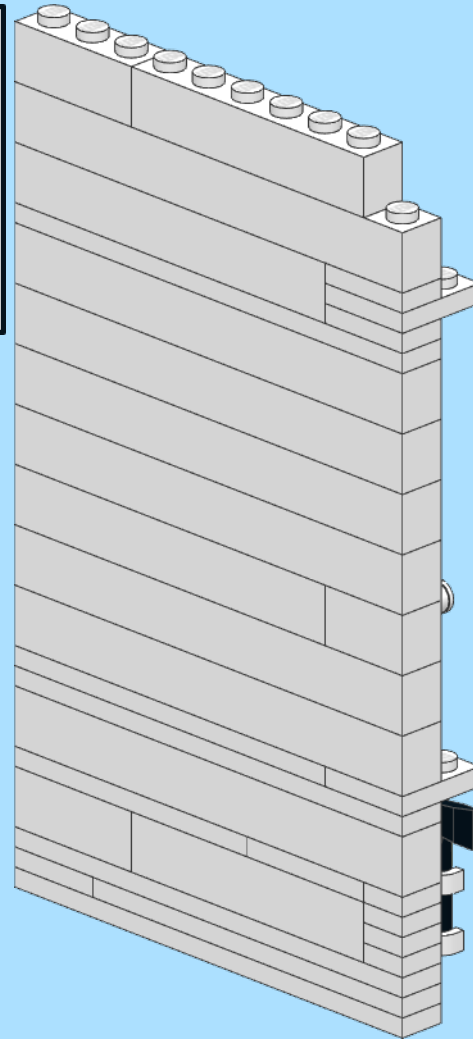
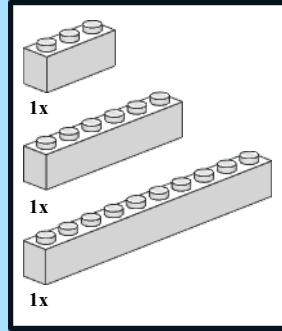

12

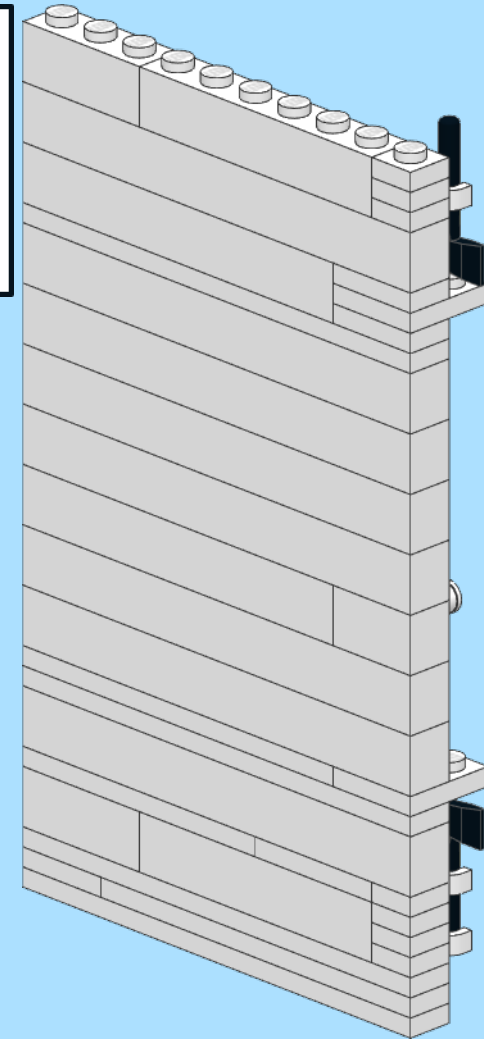
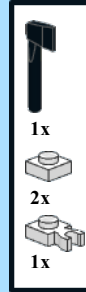



13

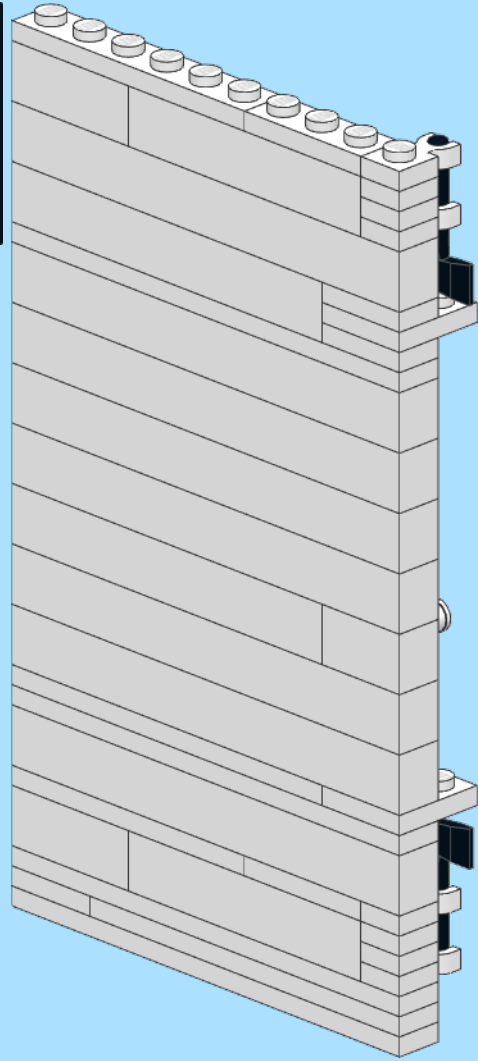
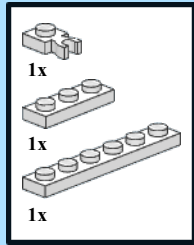

14

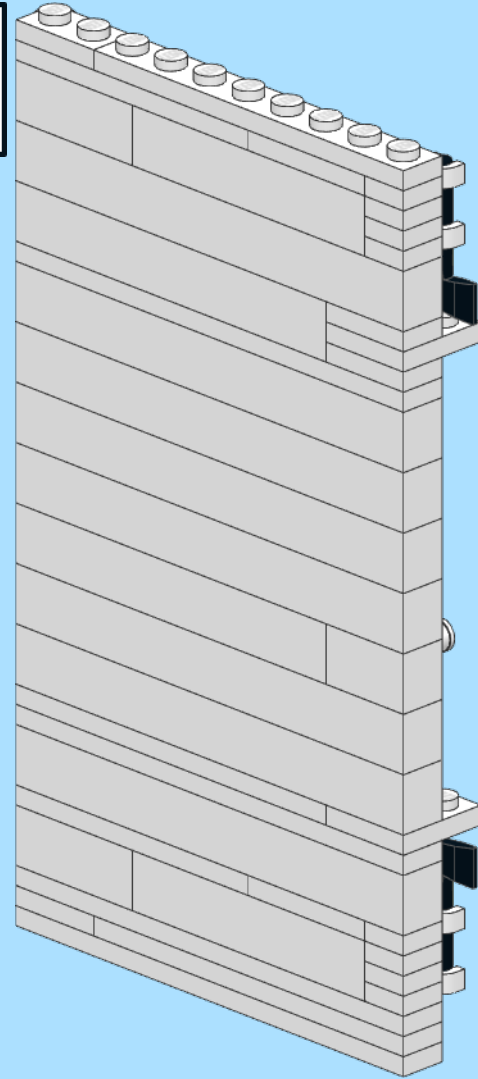
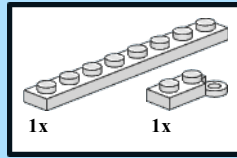

15

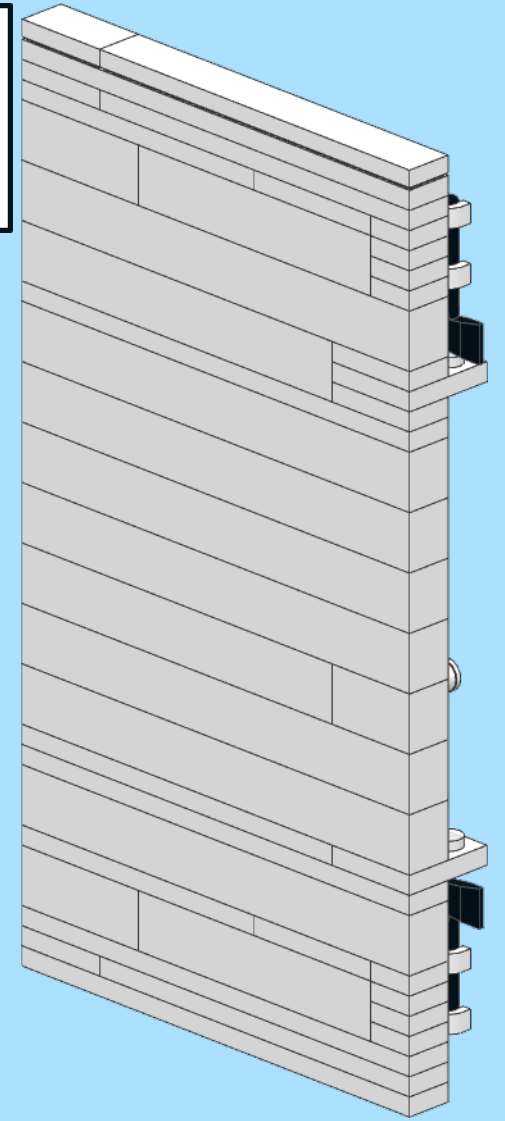
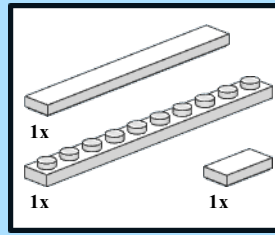

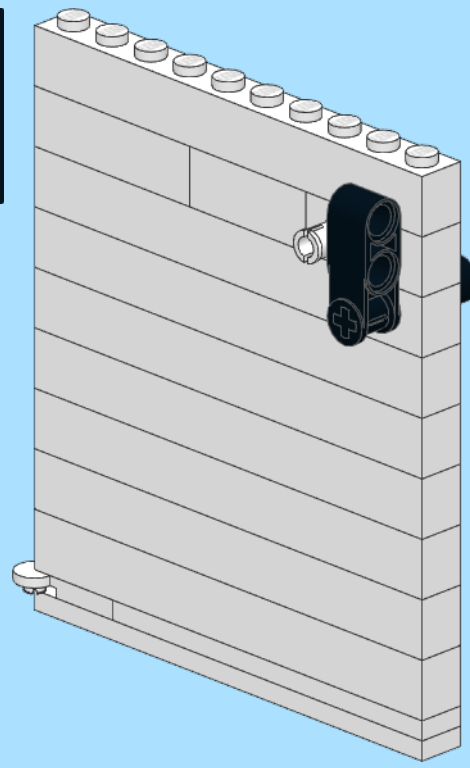
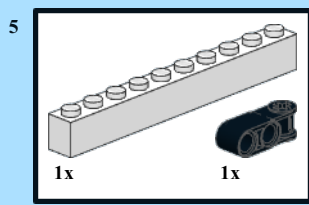
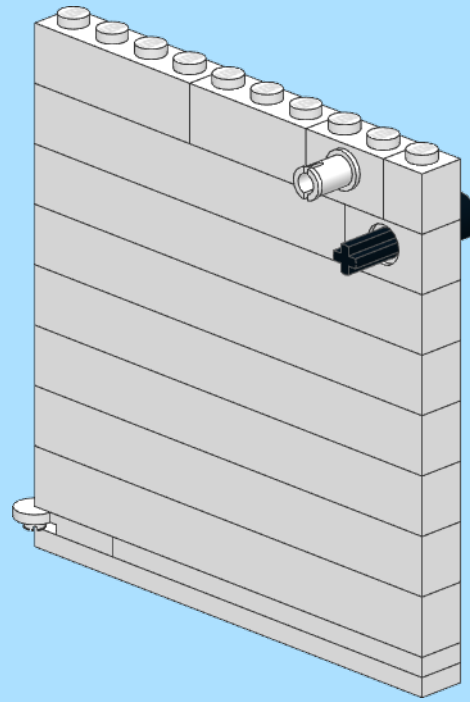
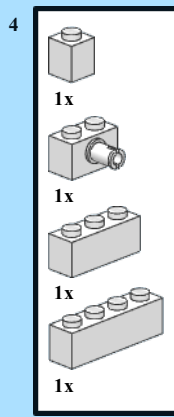
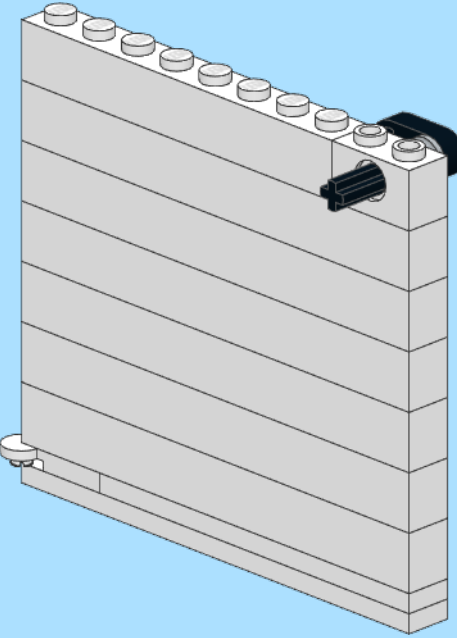
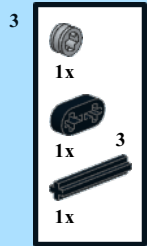
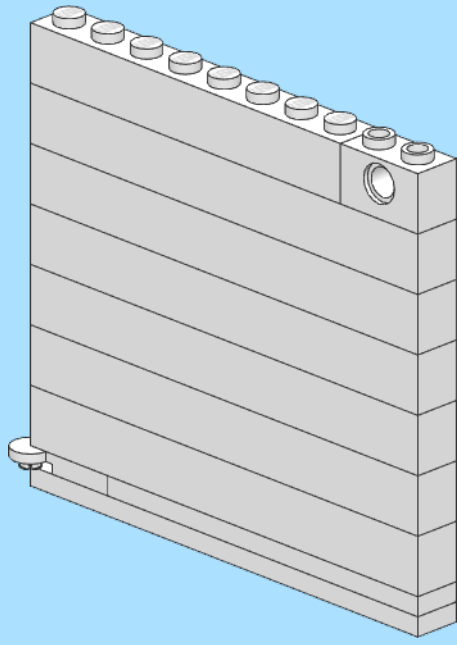
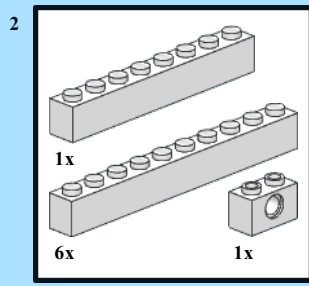
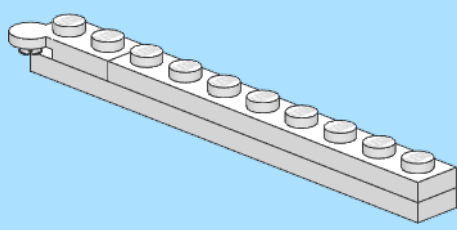
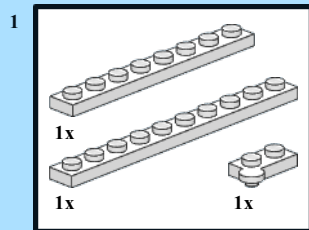

6

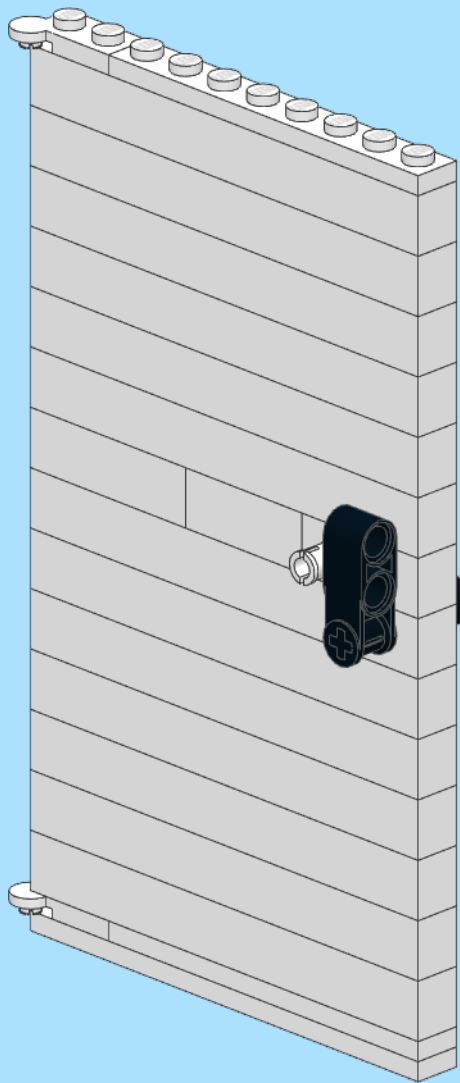
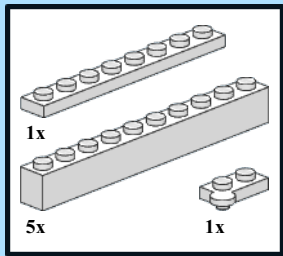

7

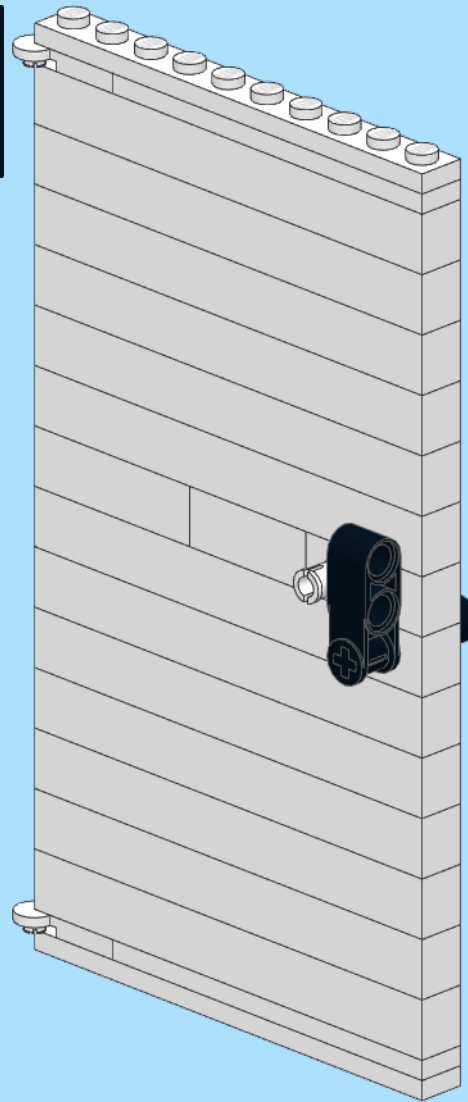
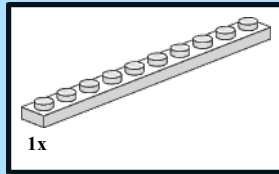

8

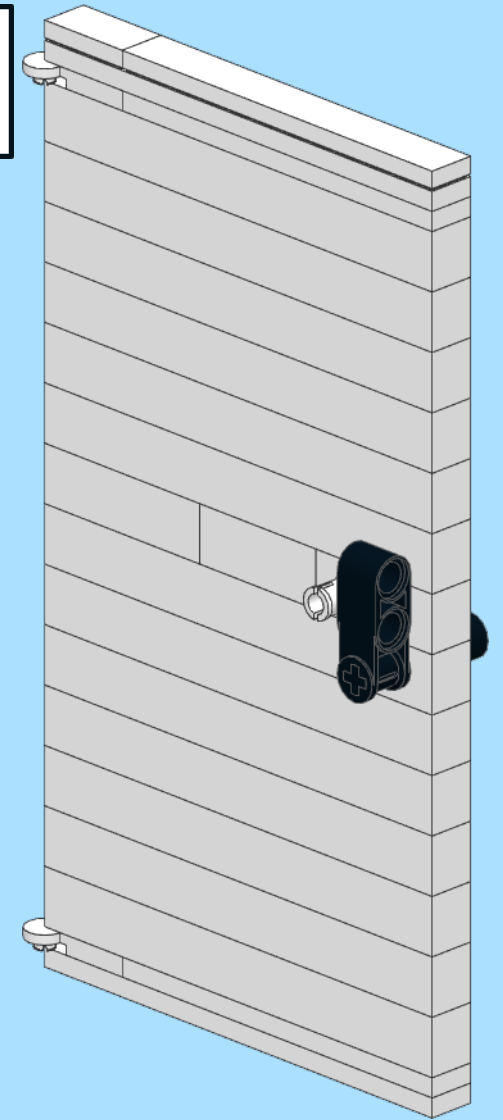
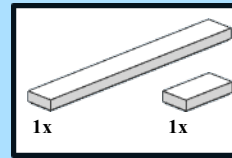

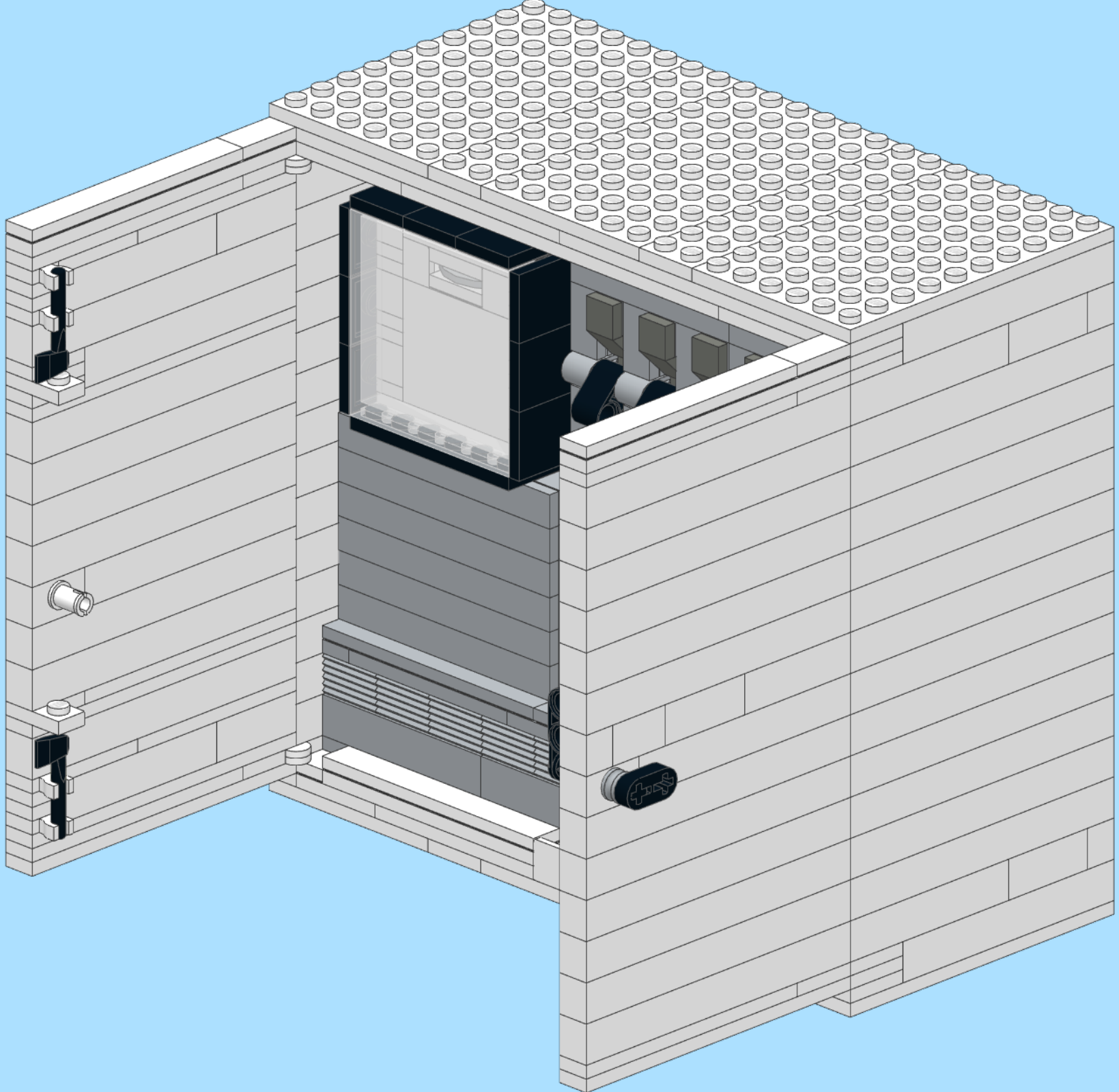

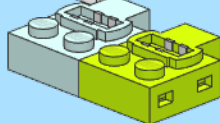
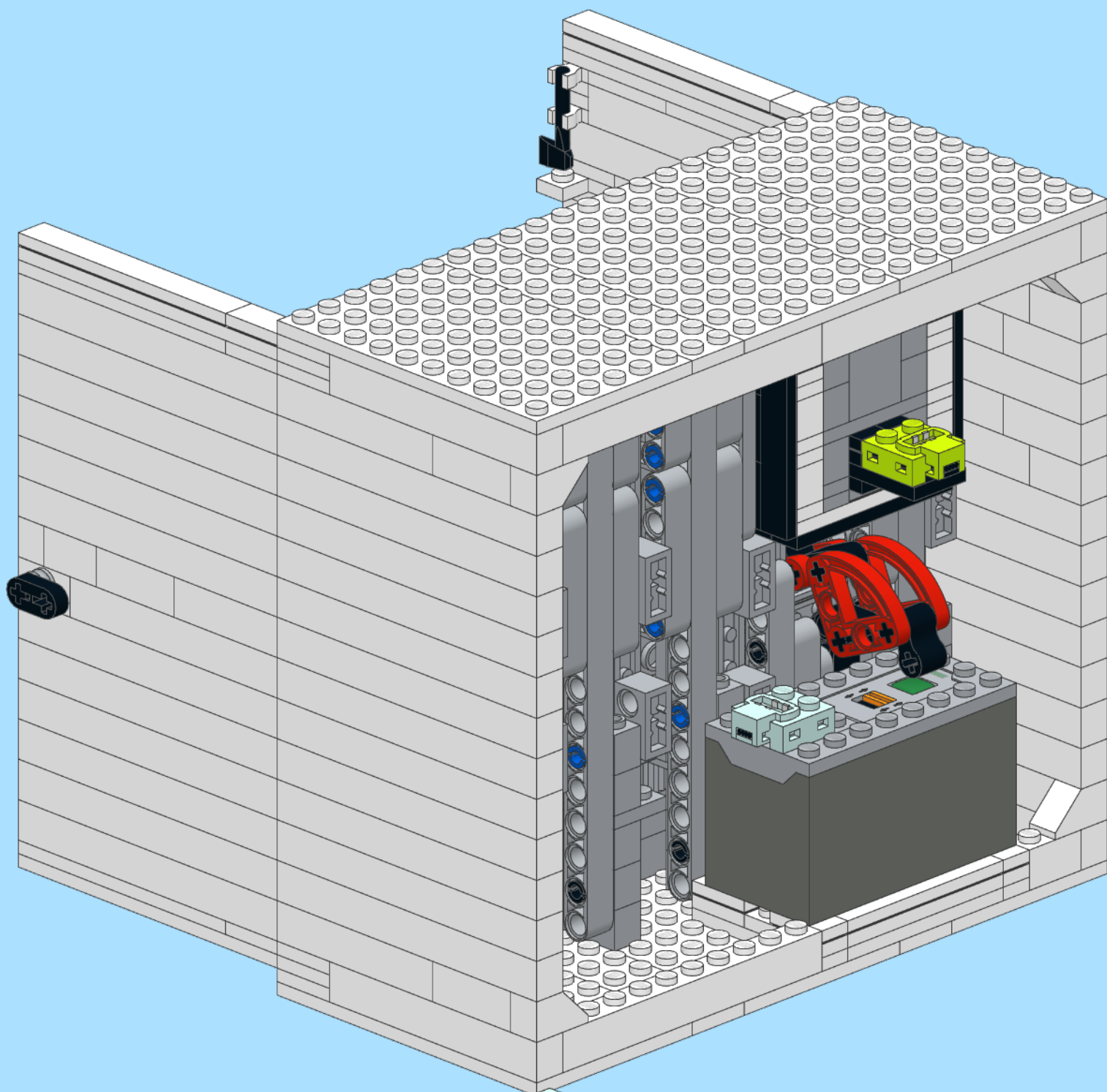

1

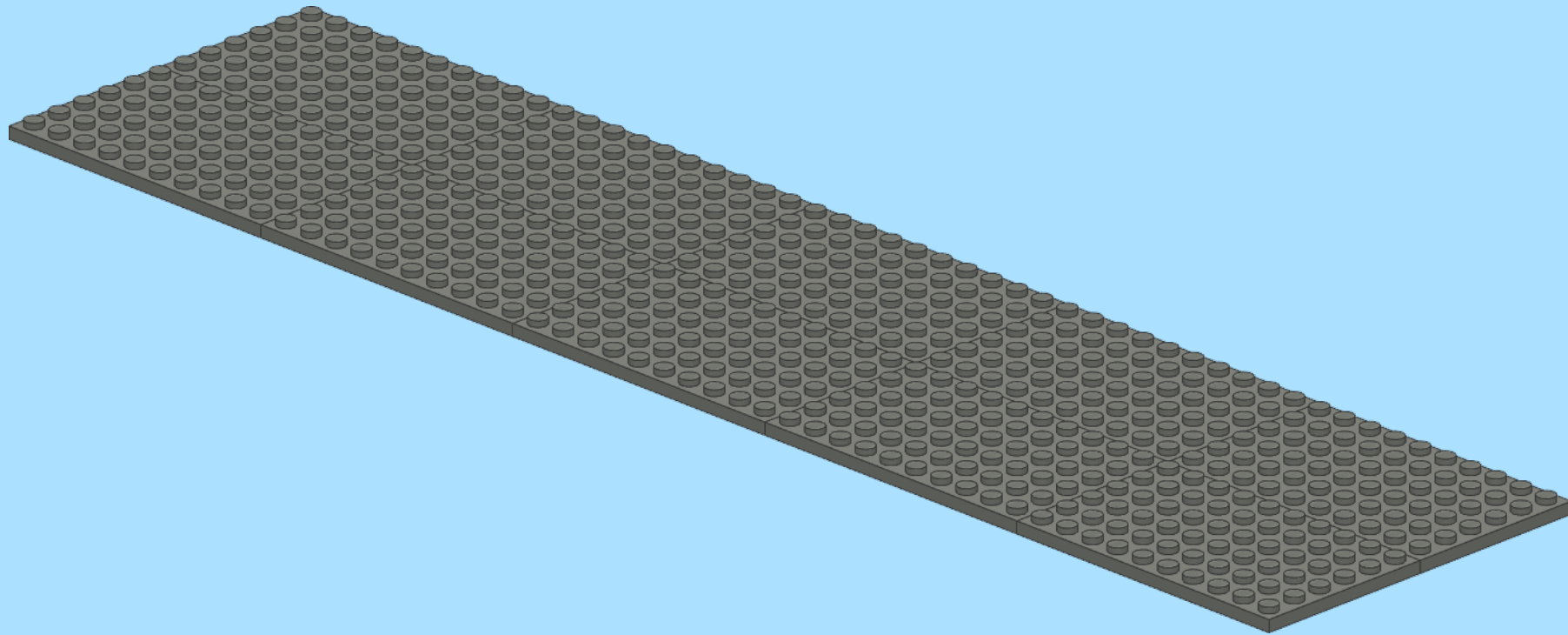
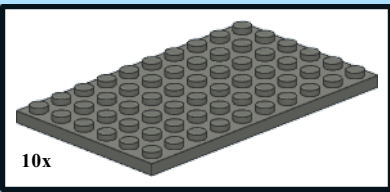

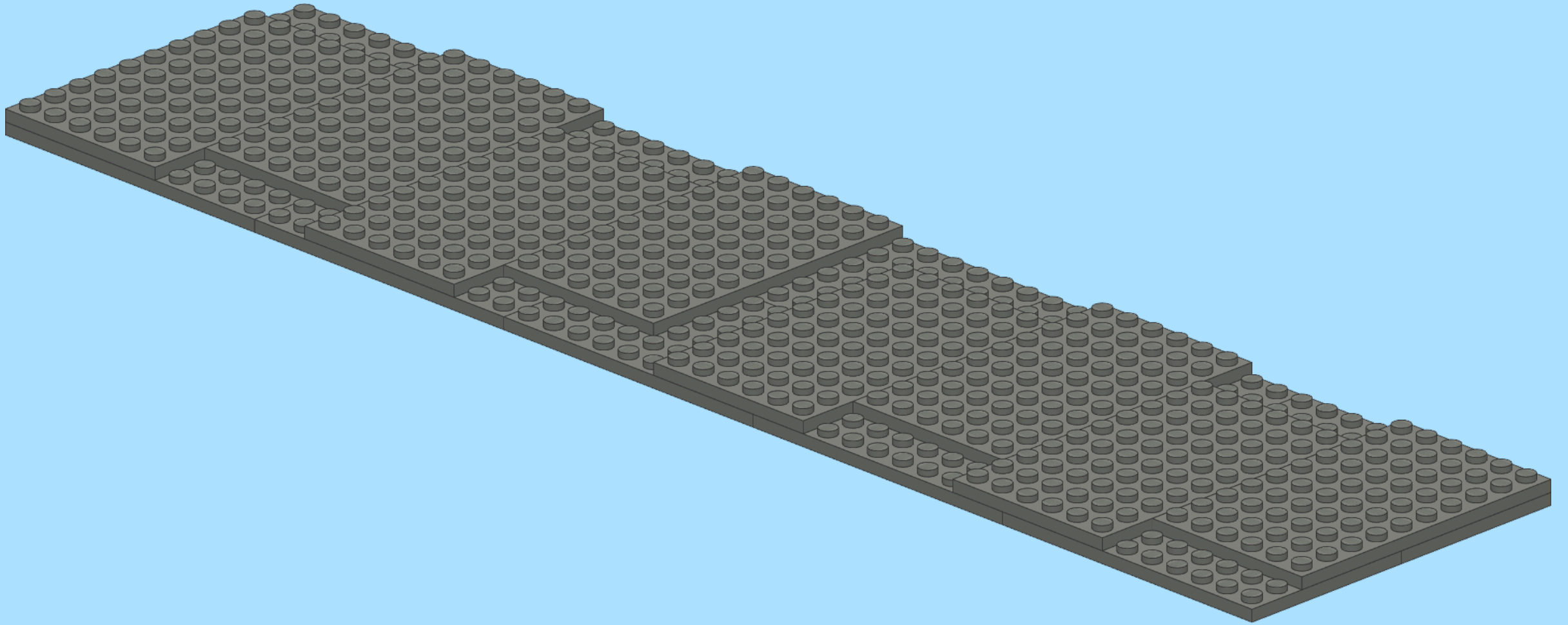
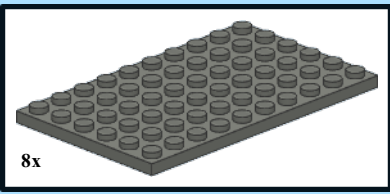

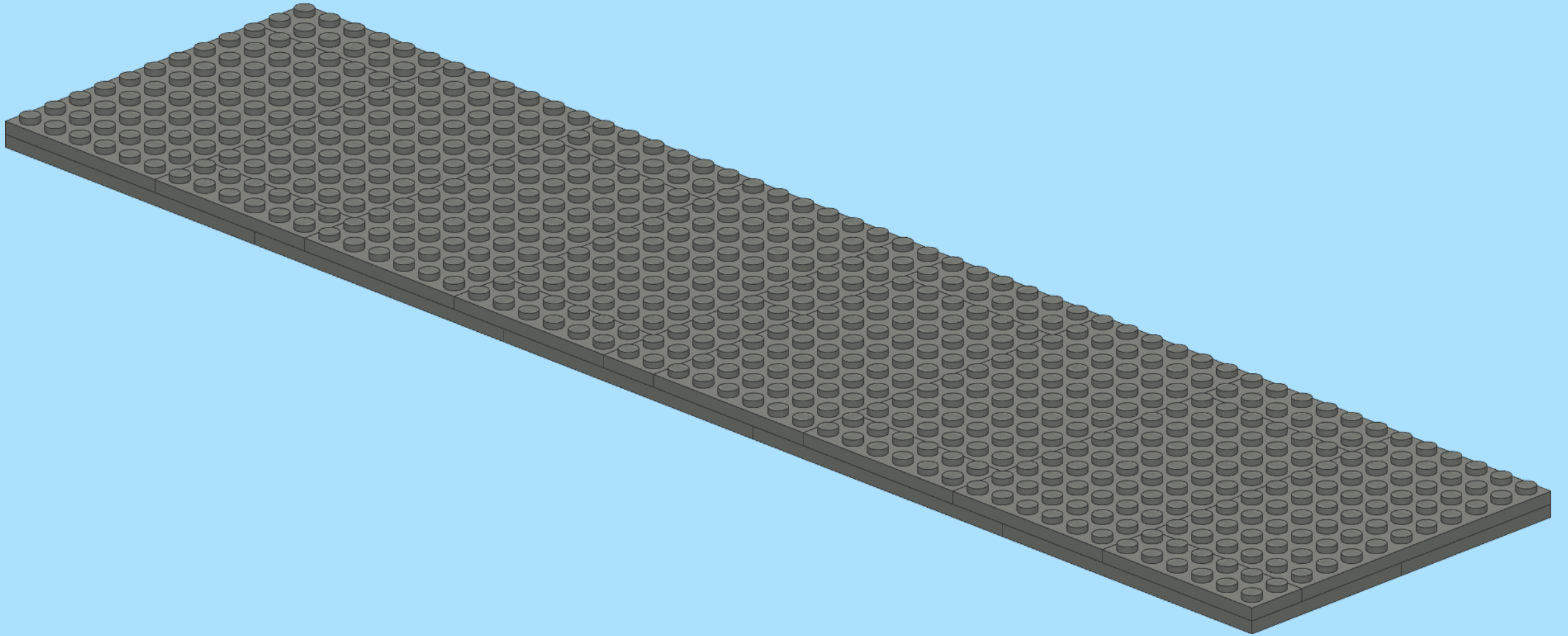
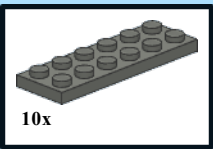



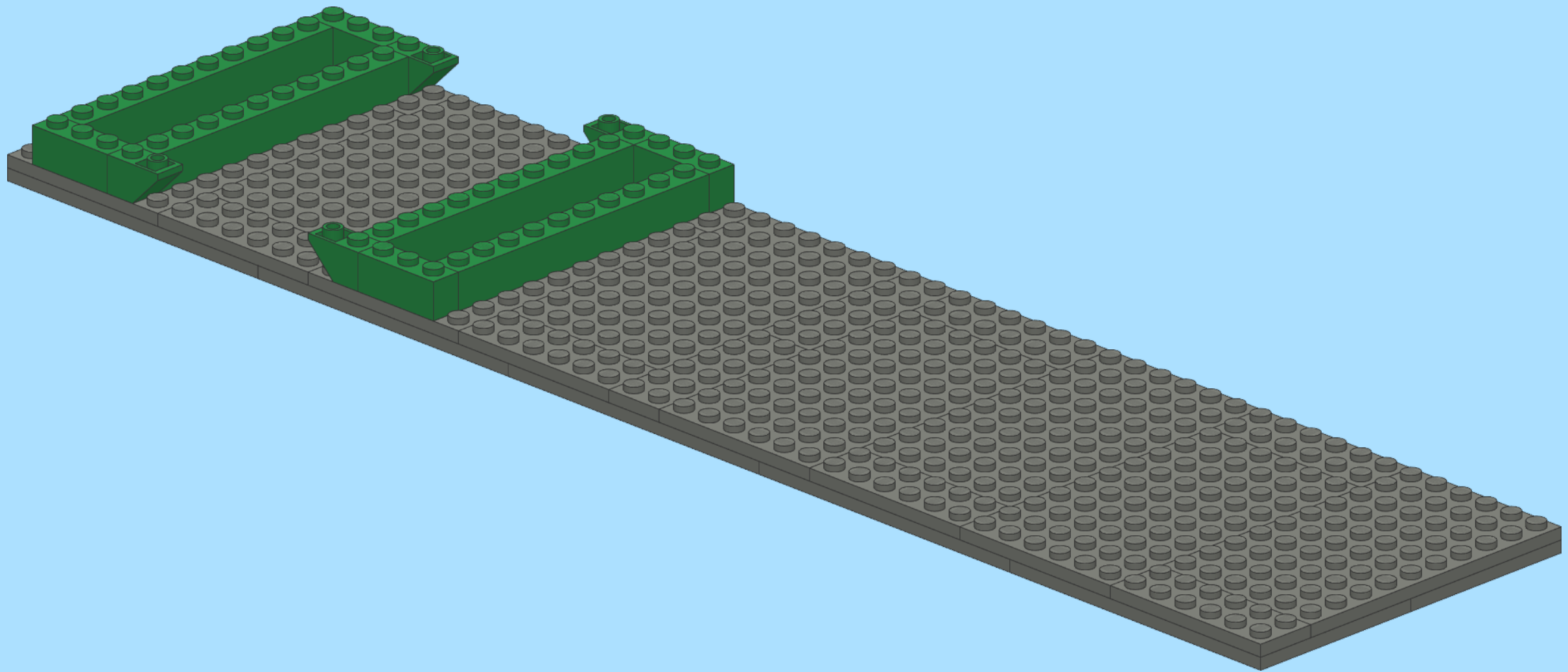
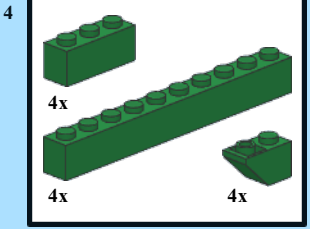

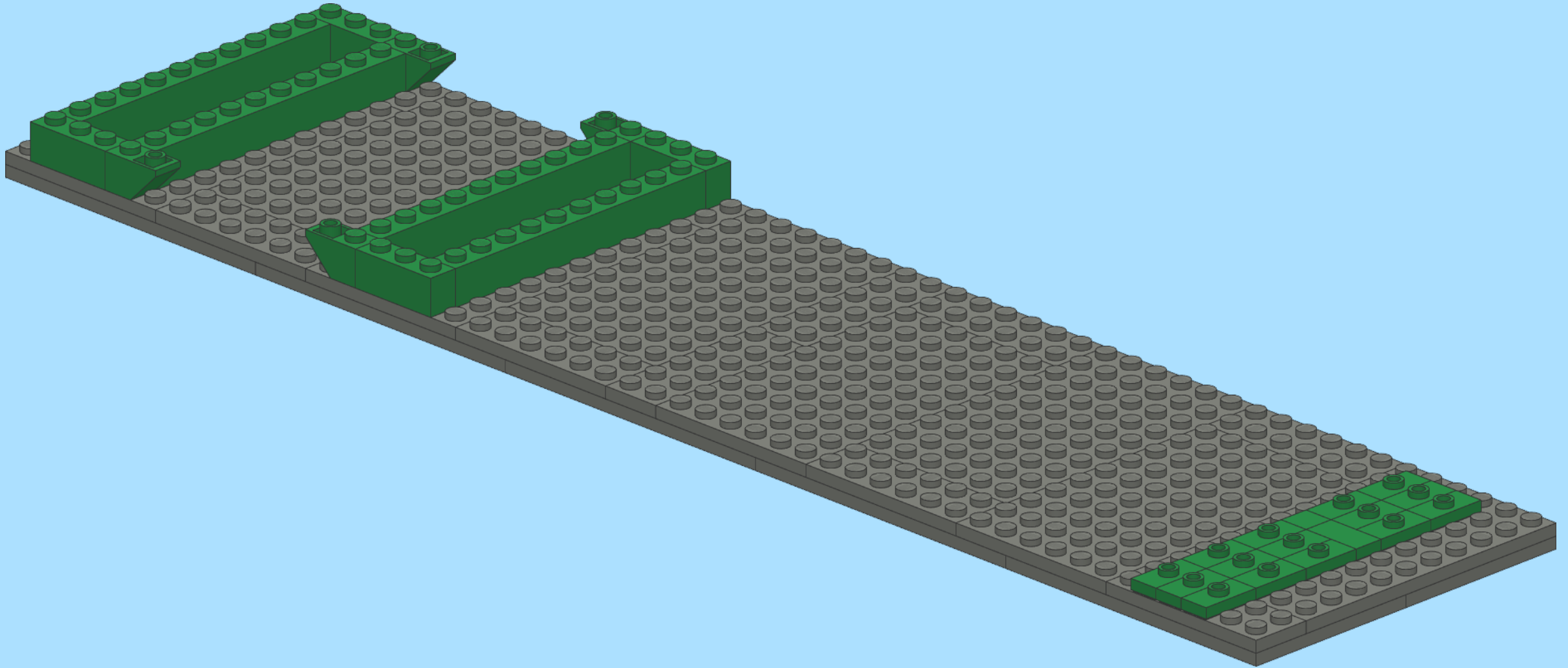
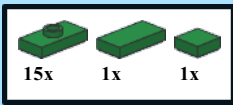



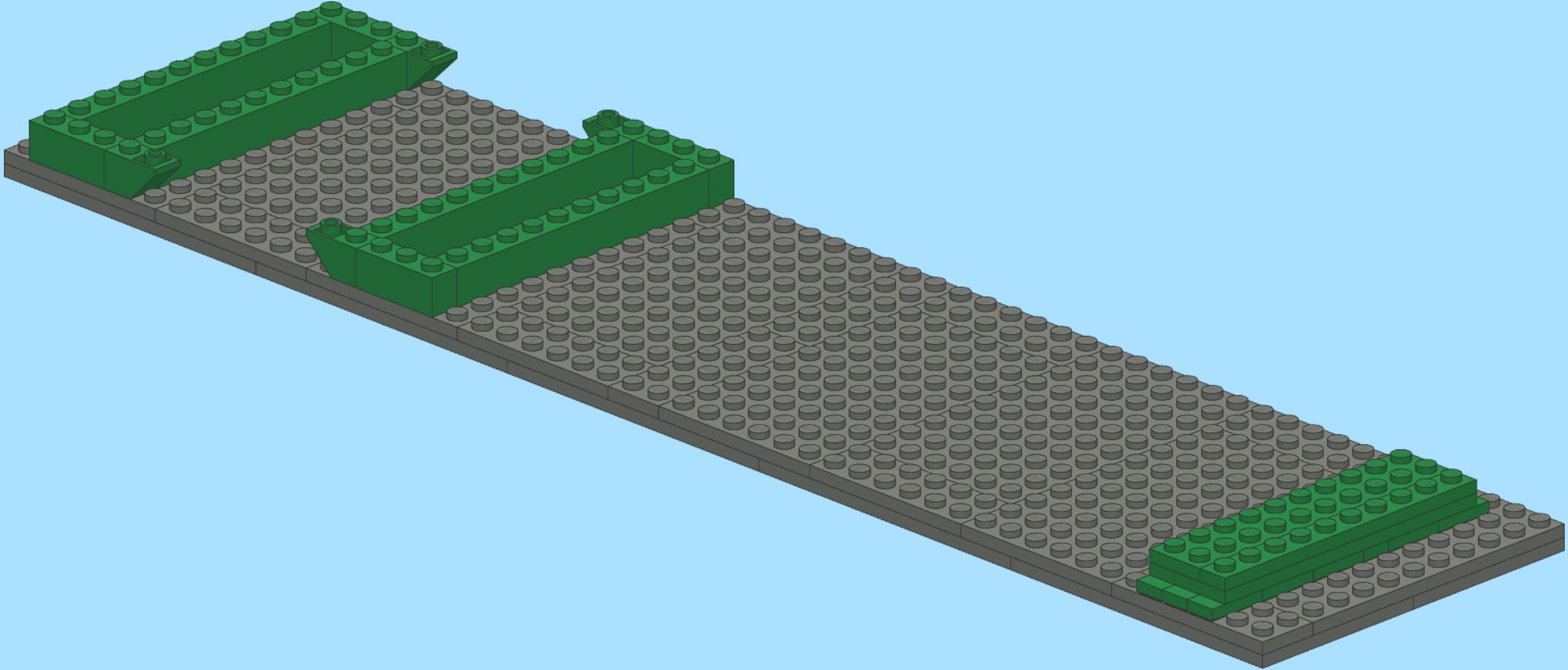
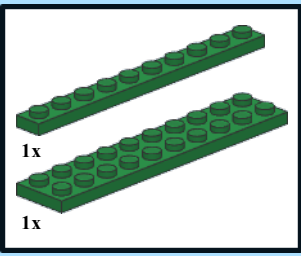

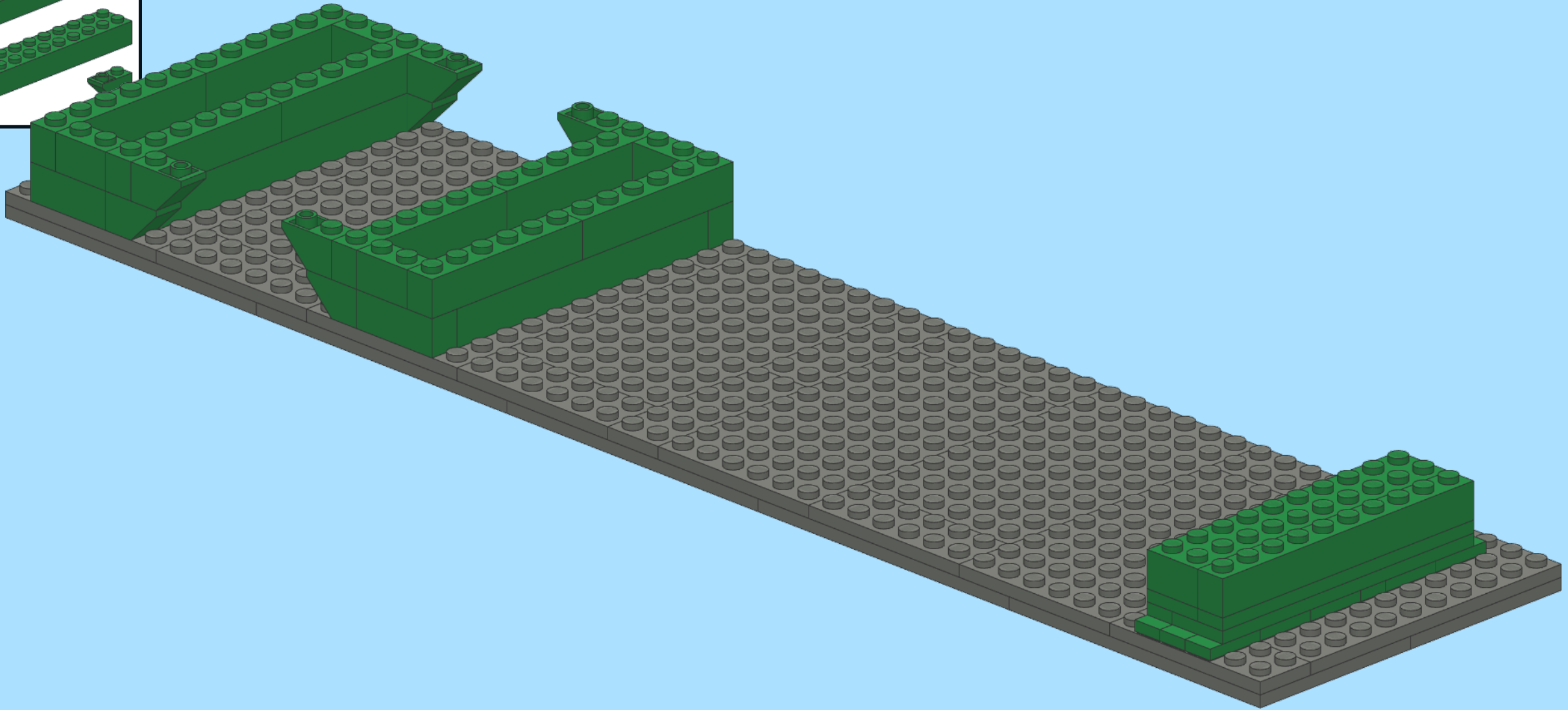
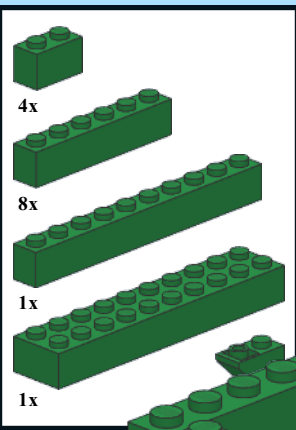

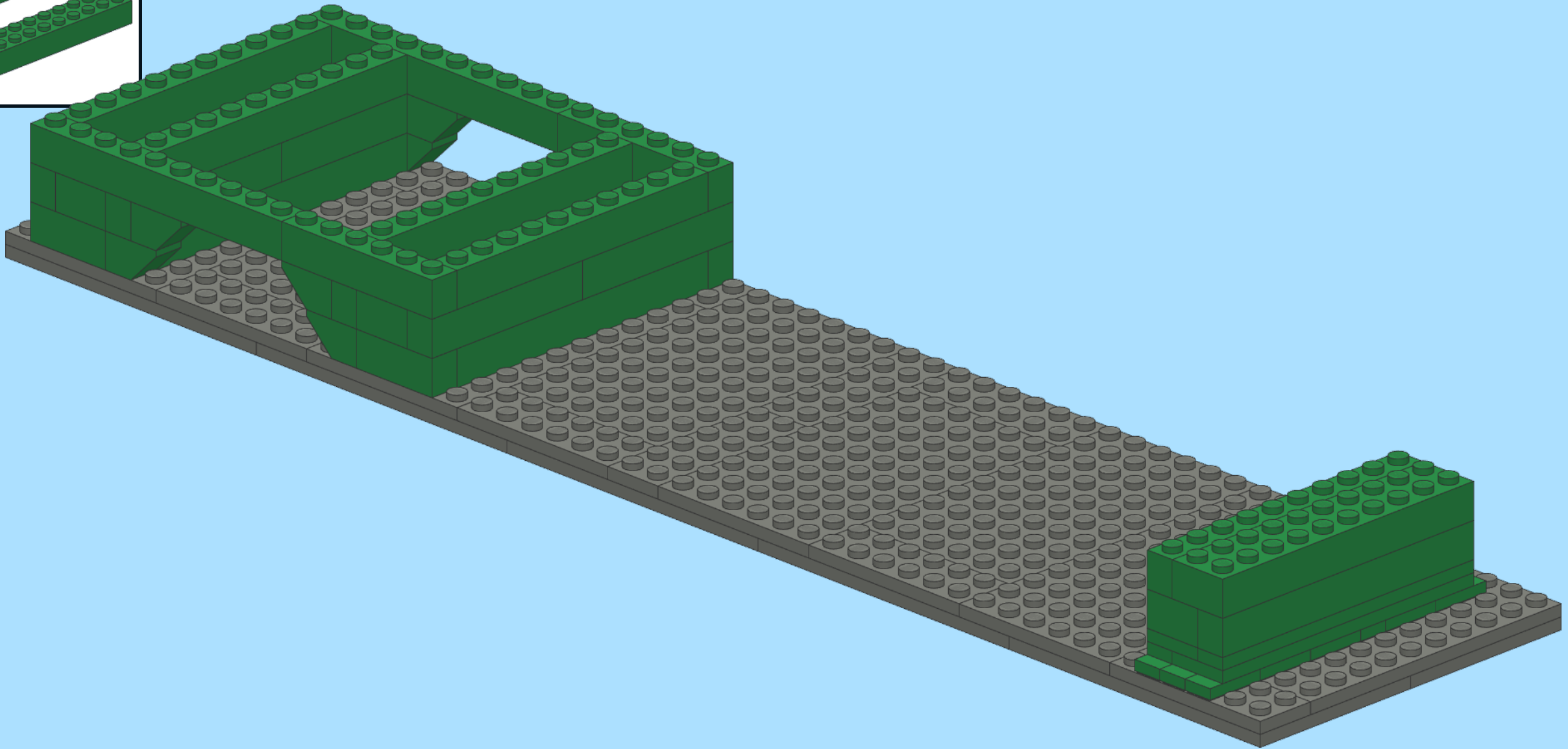
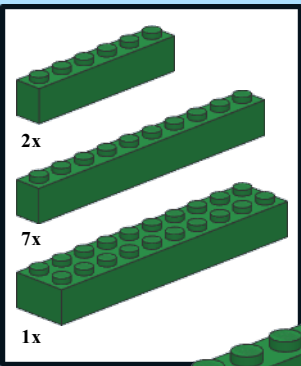

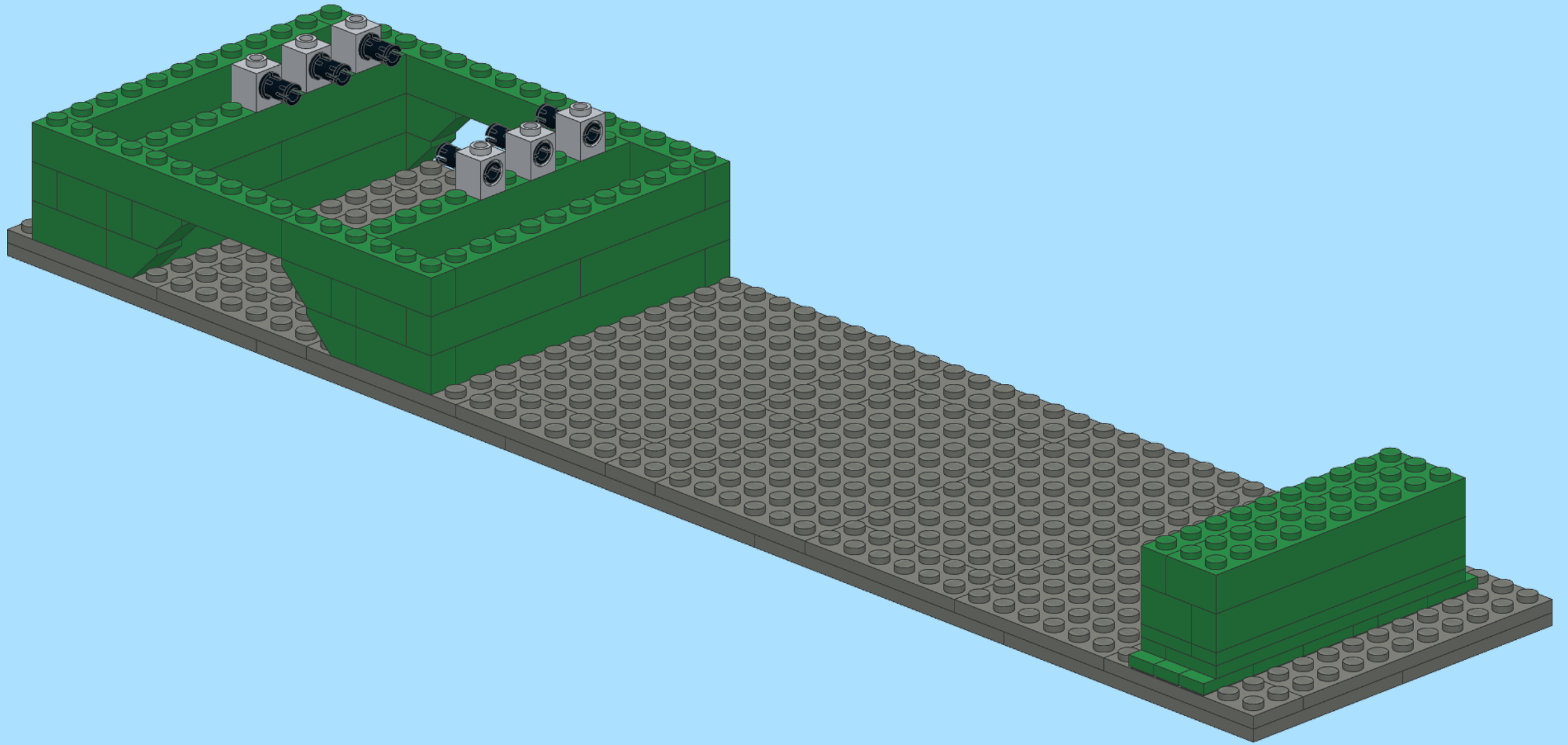

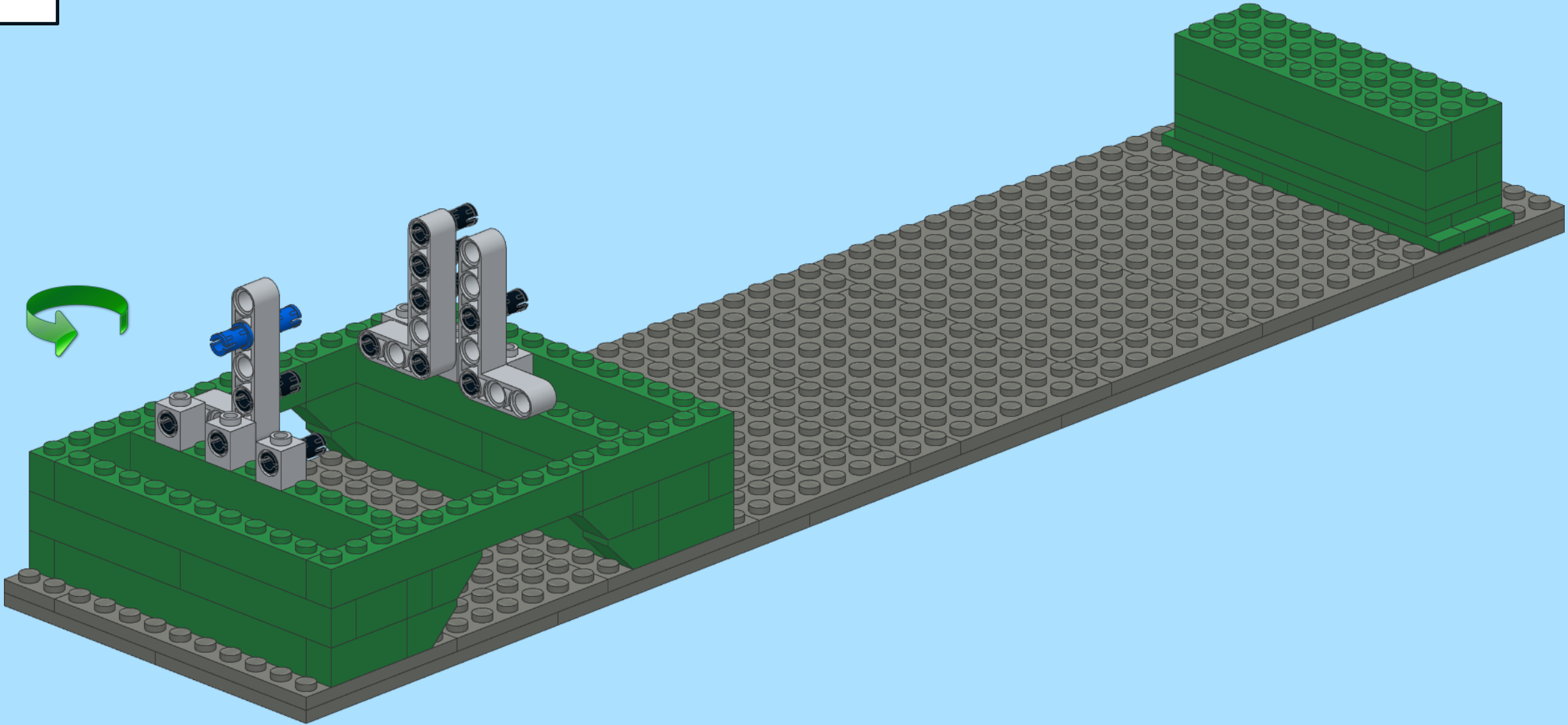
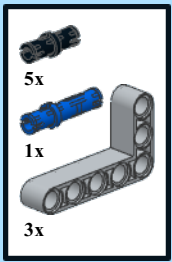



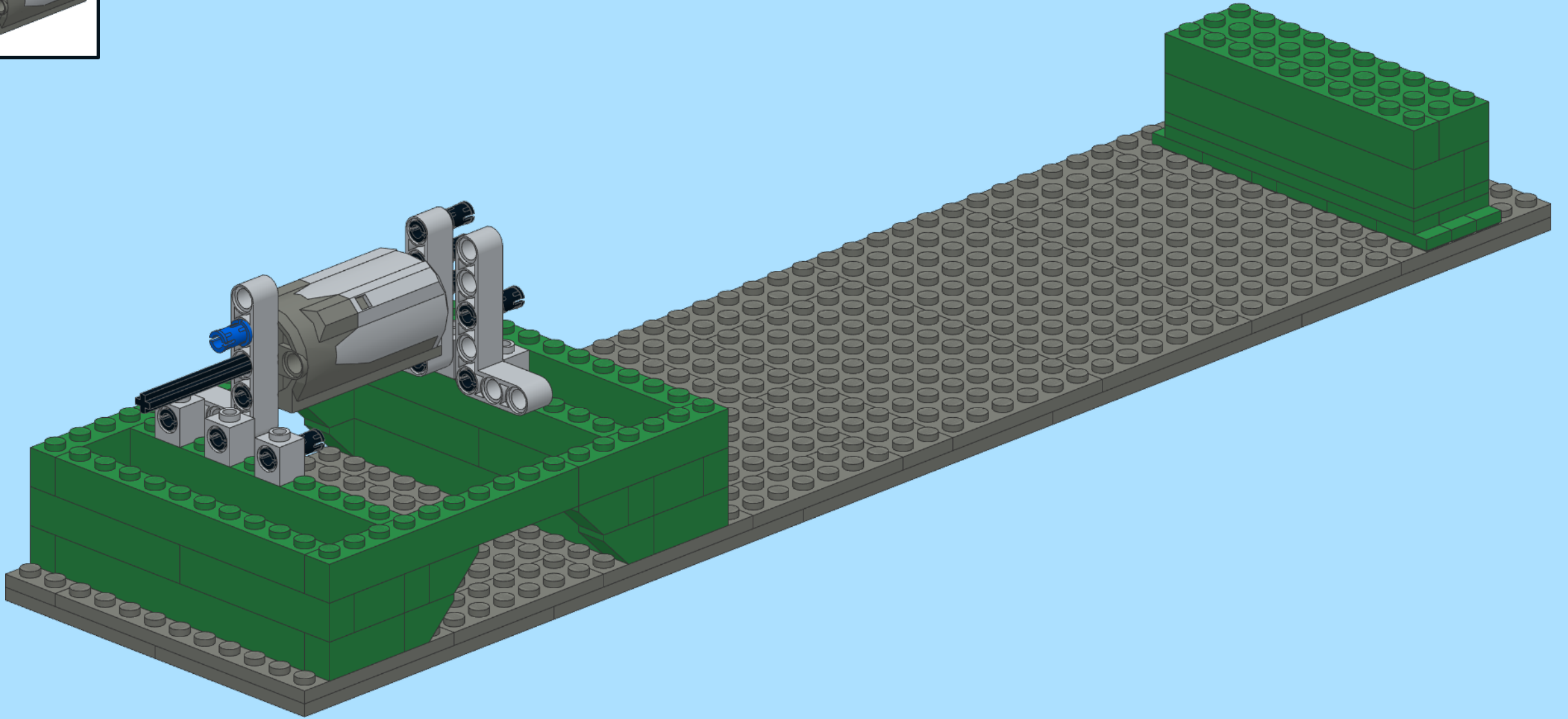
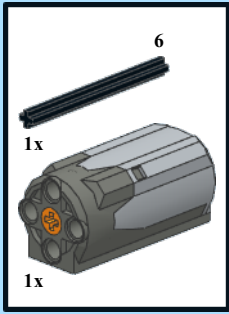

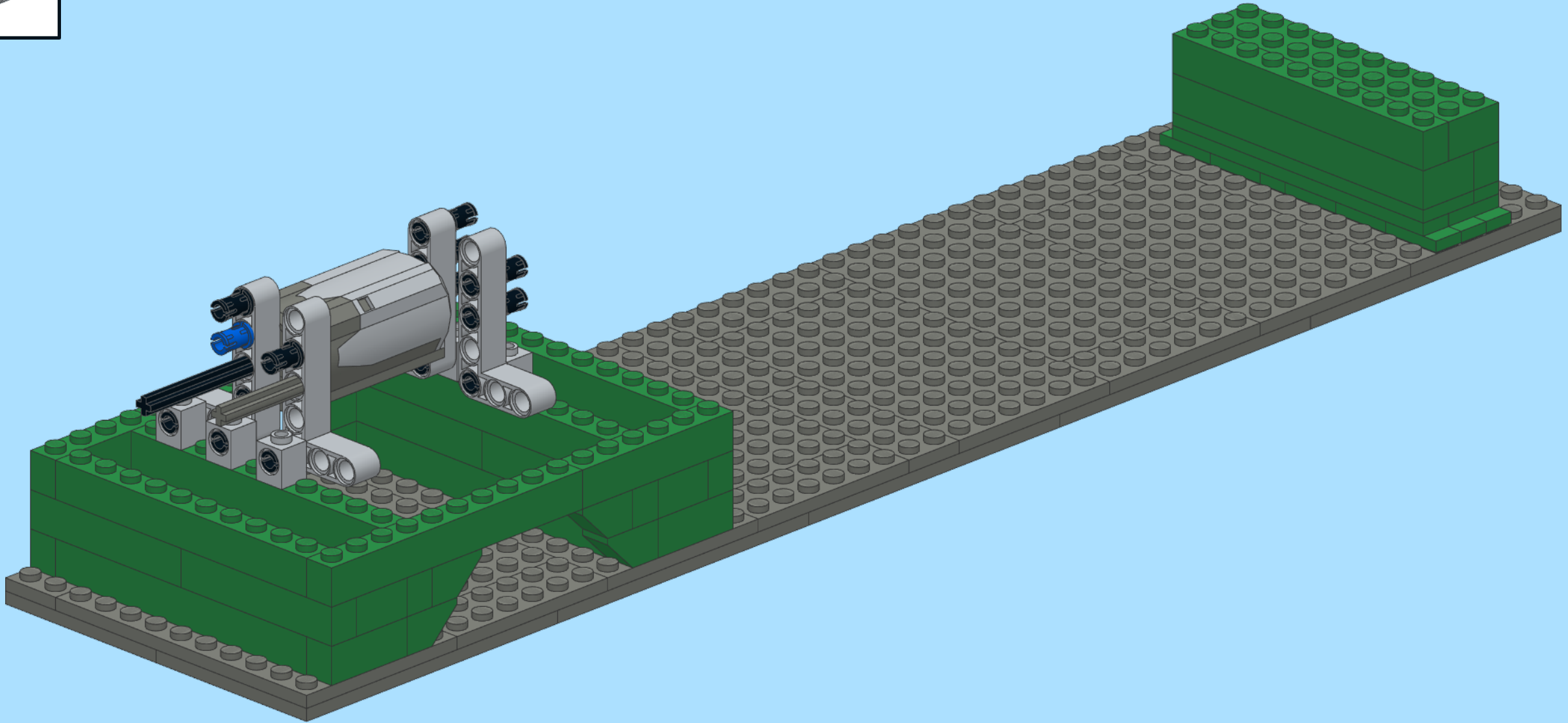
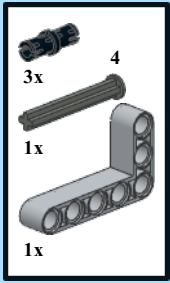

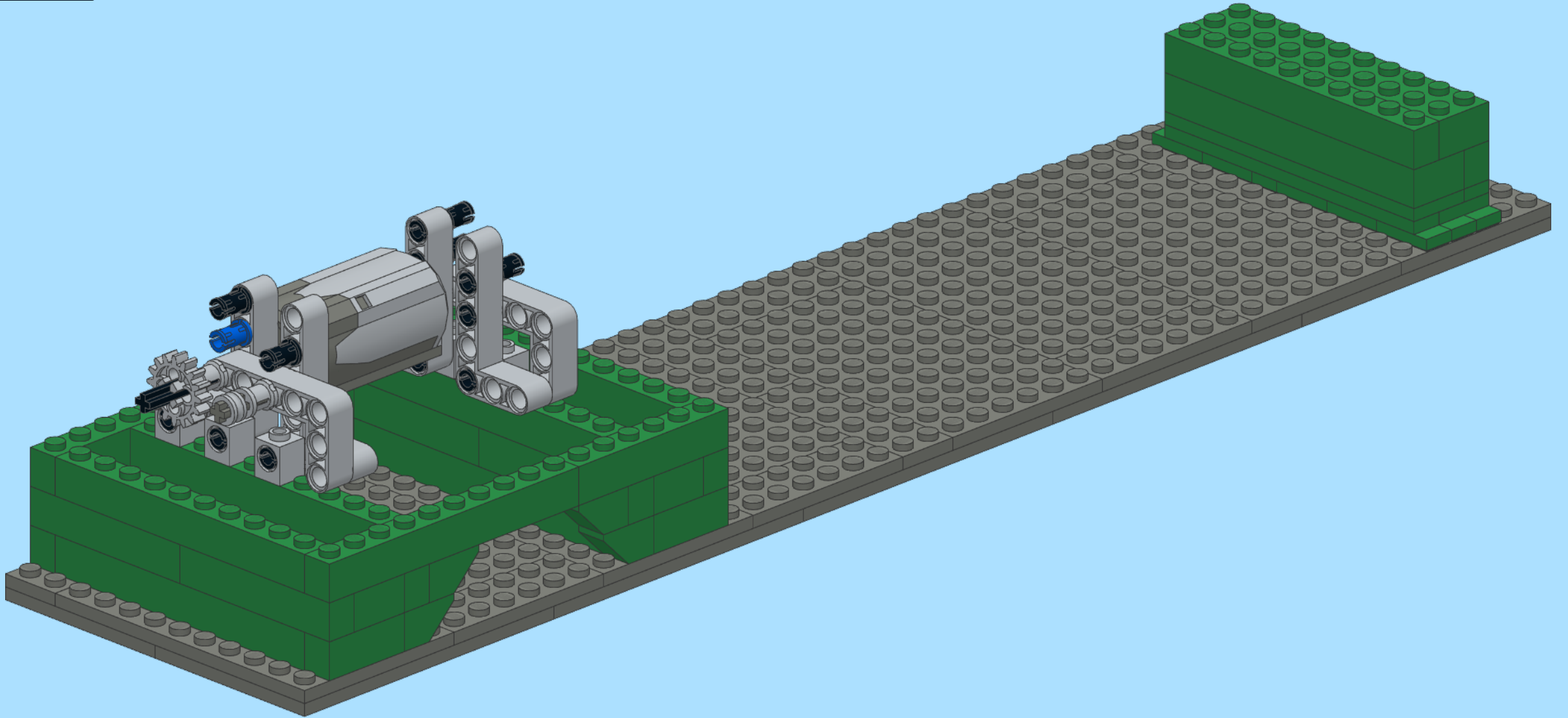
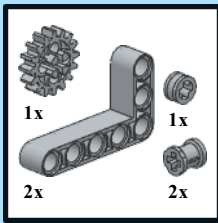

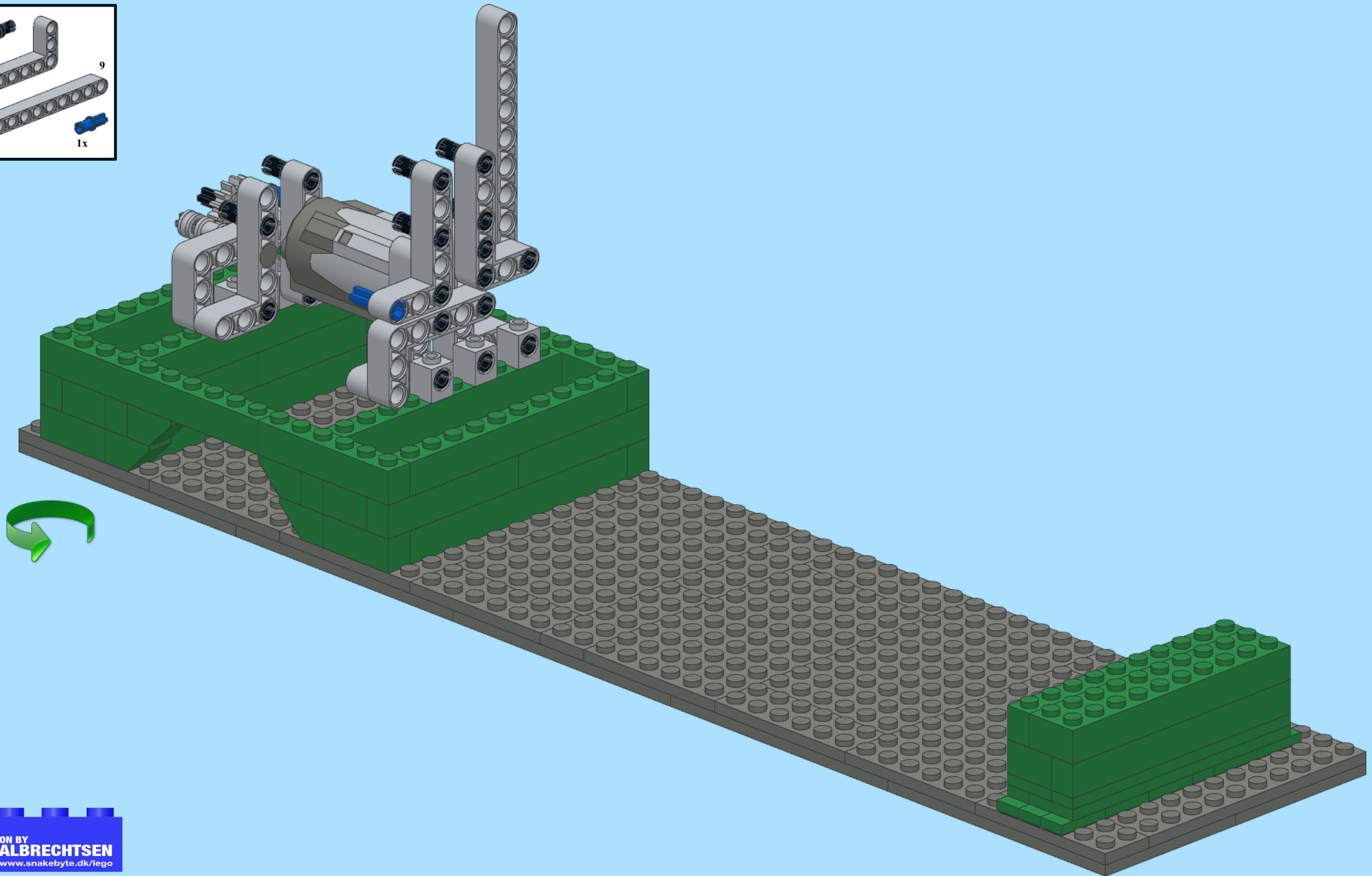
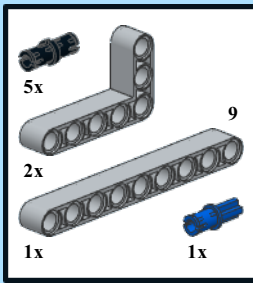

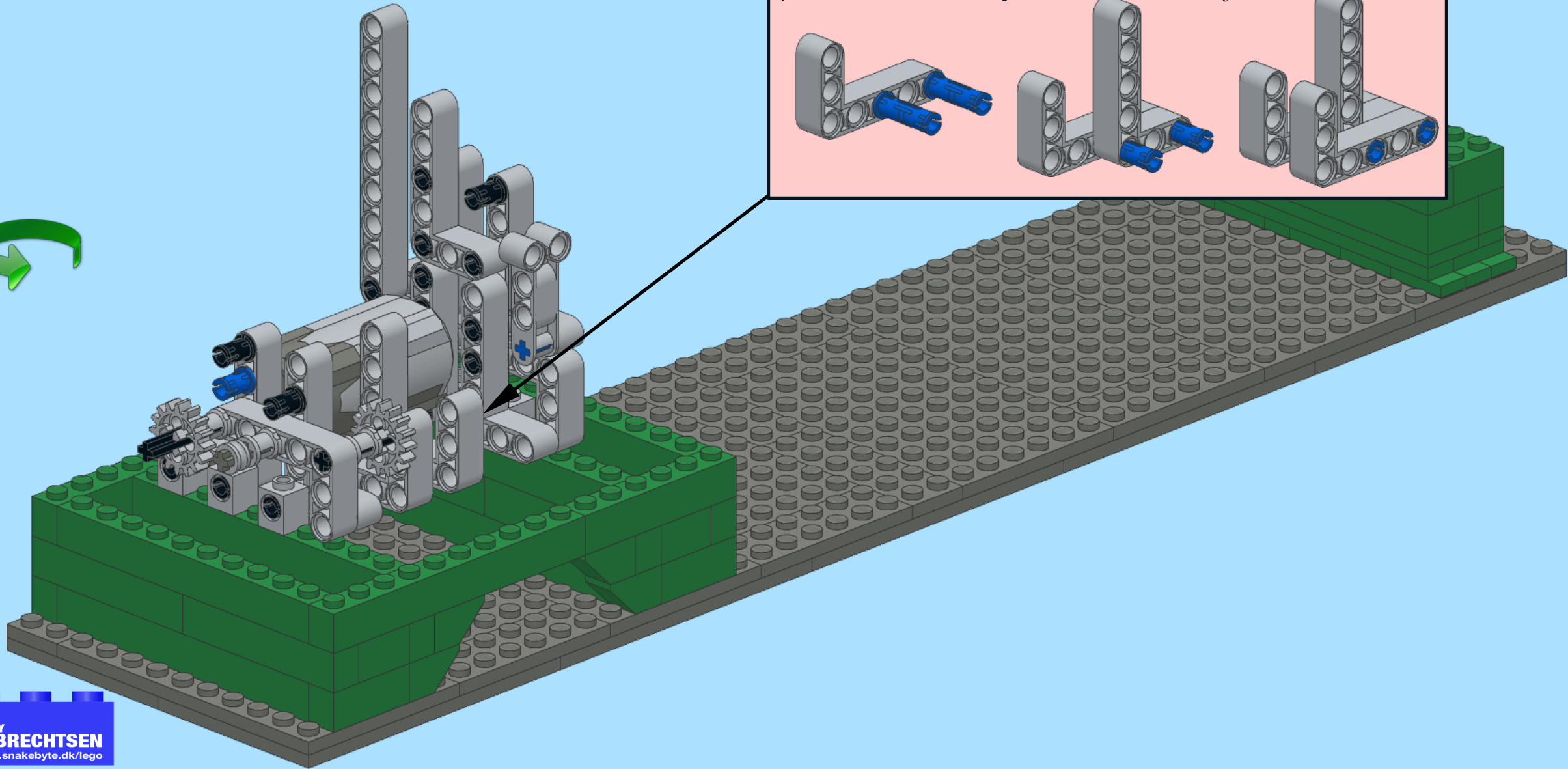
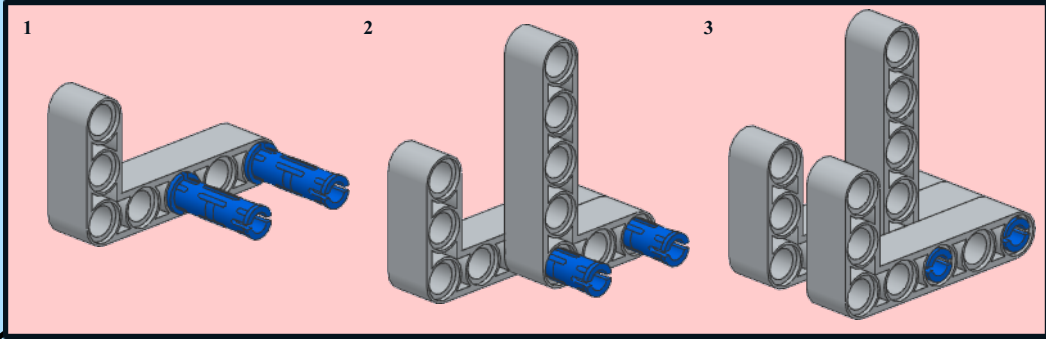
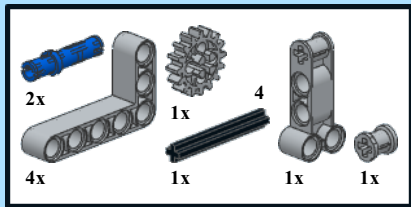

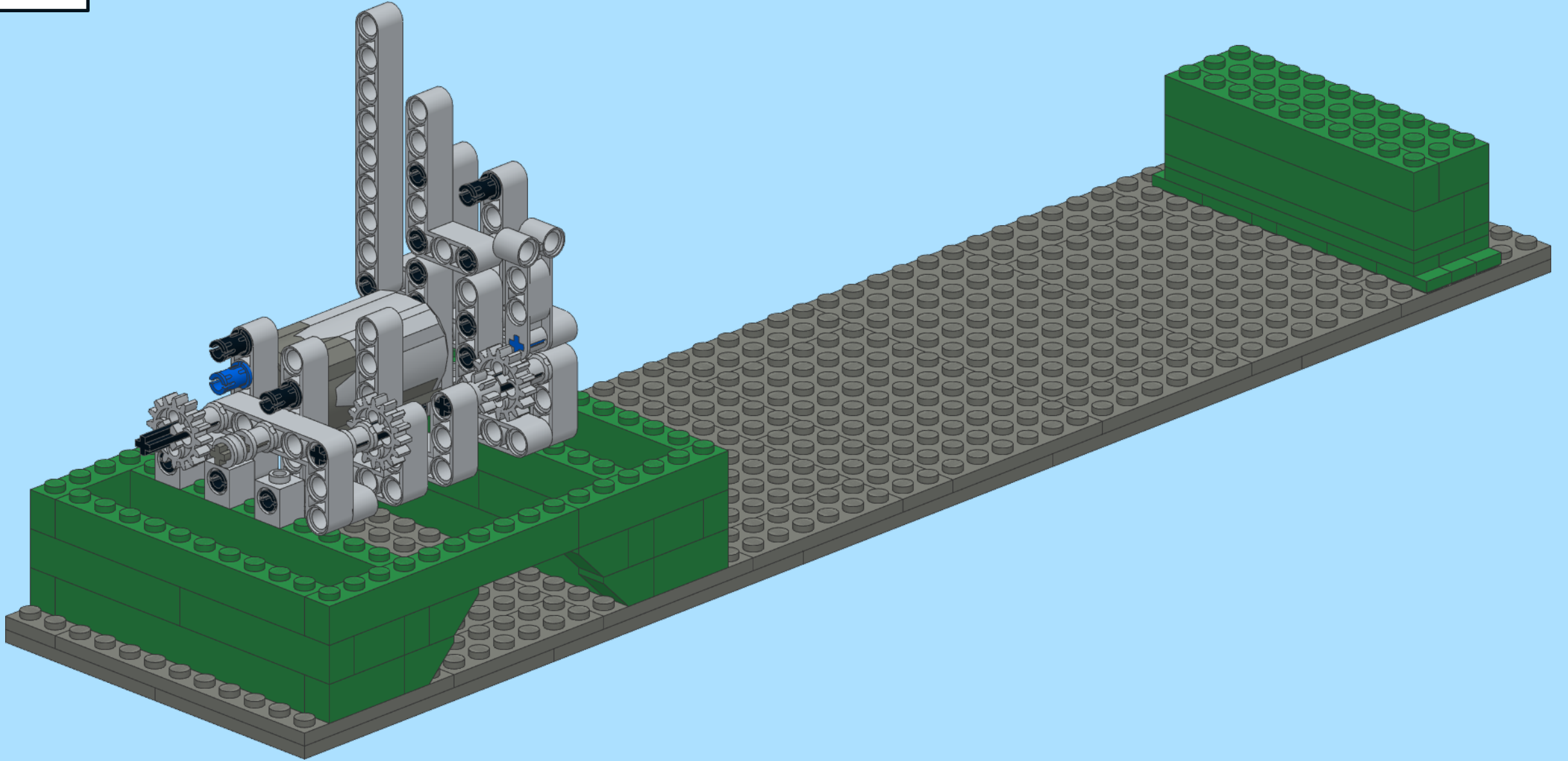
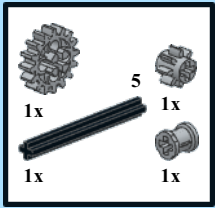

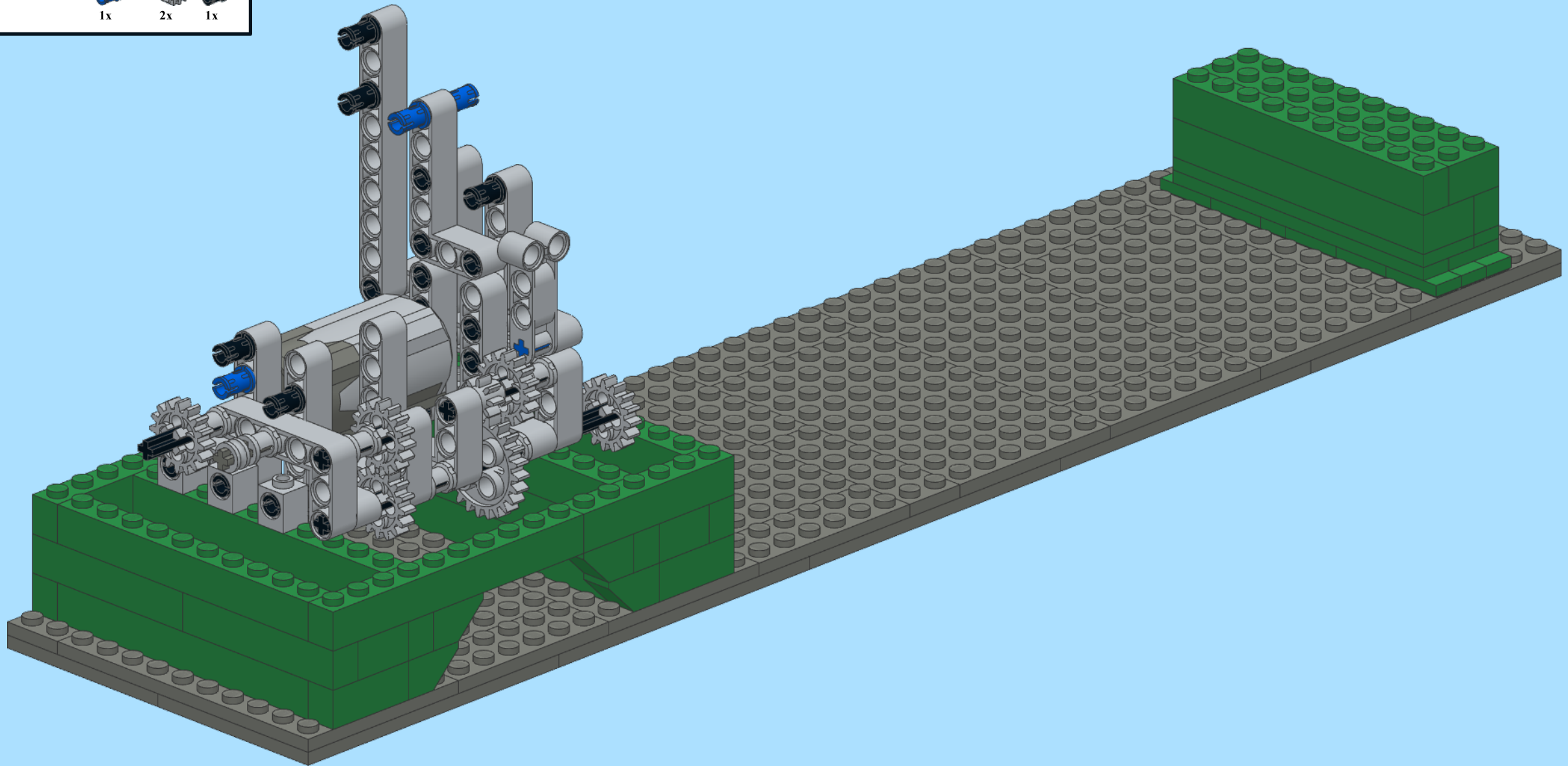
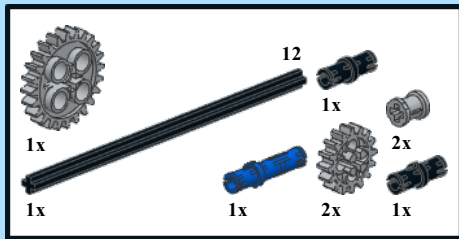

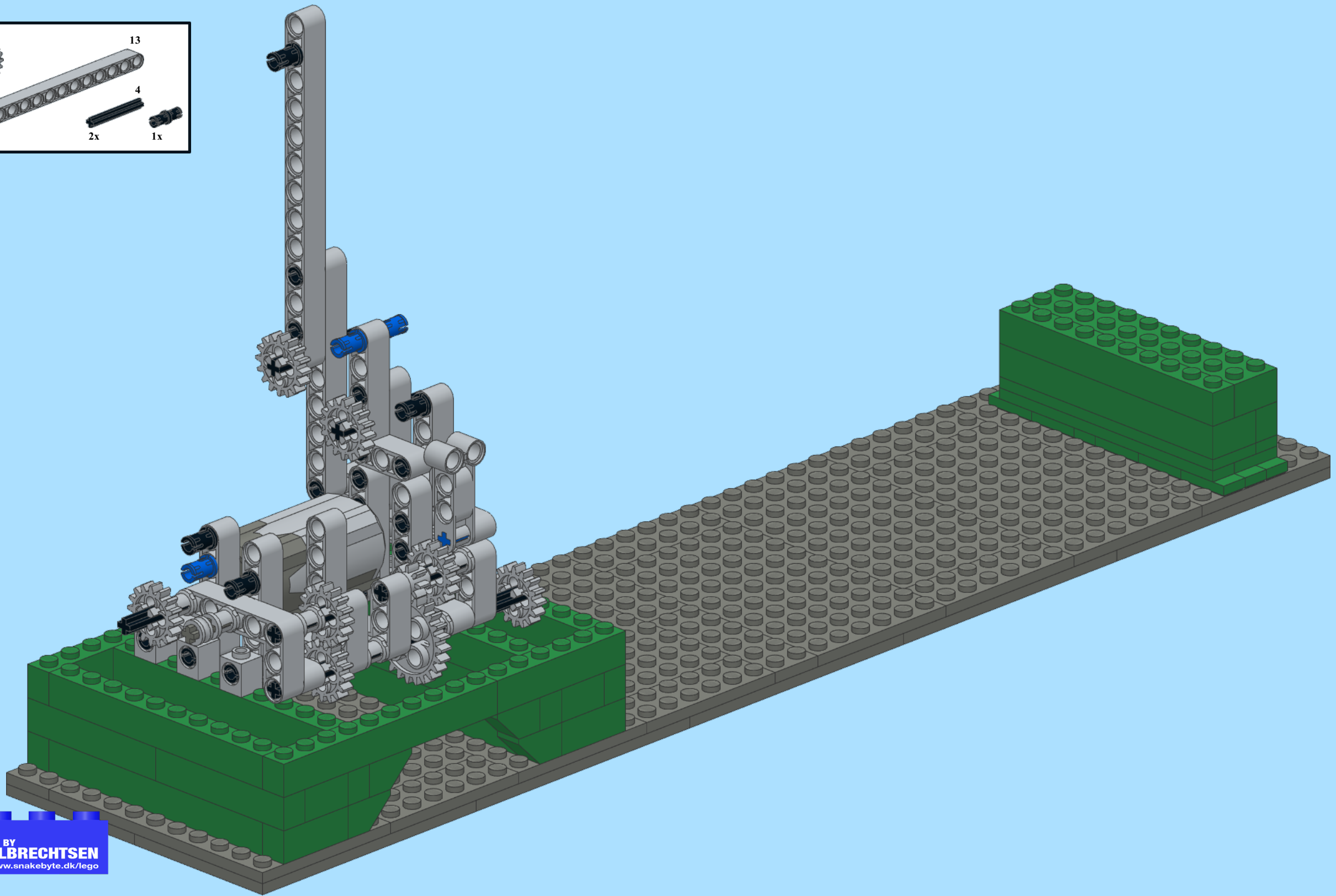
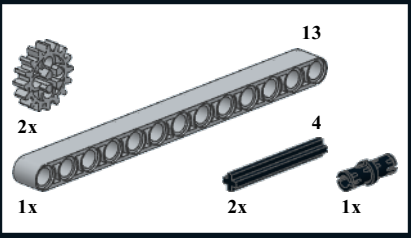



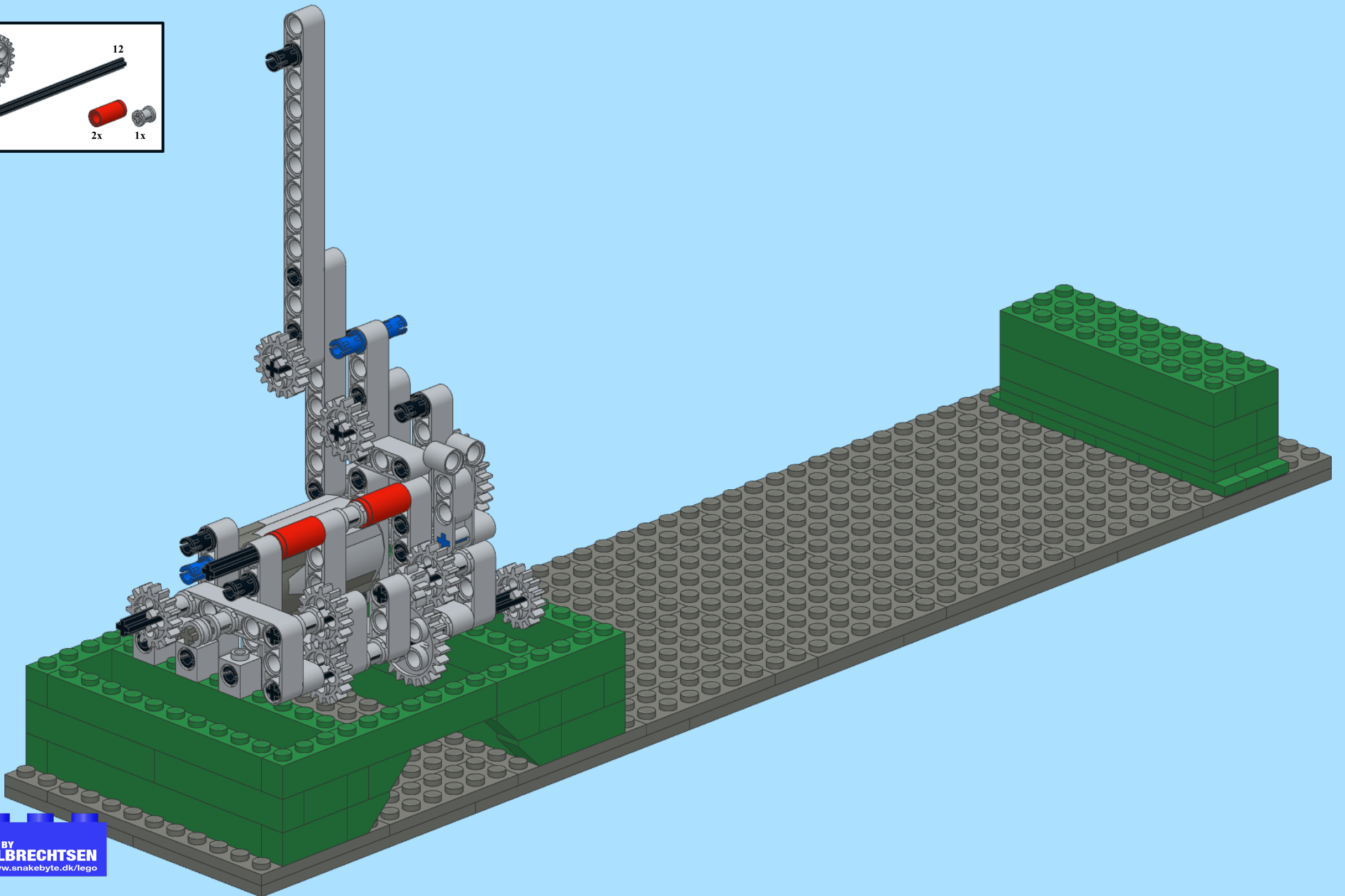
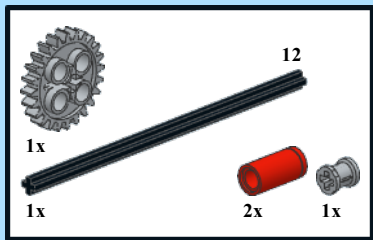

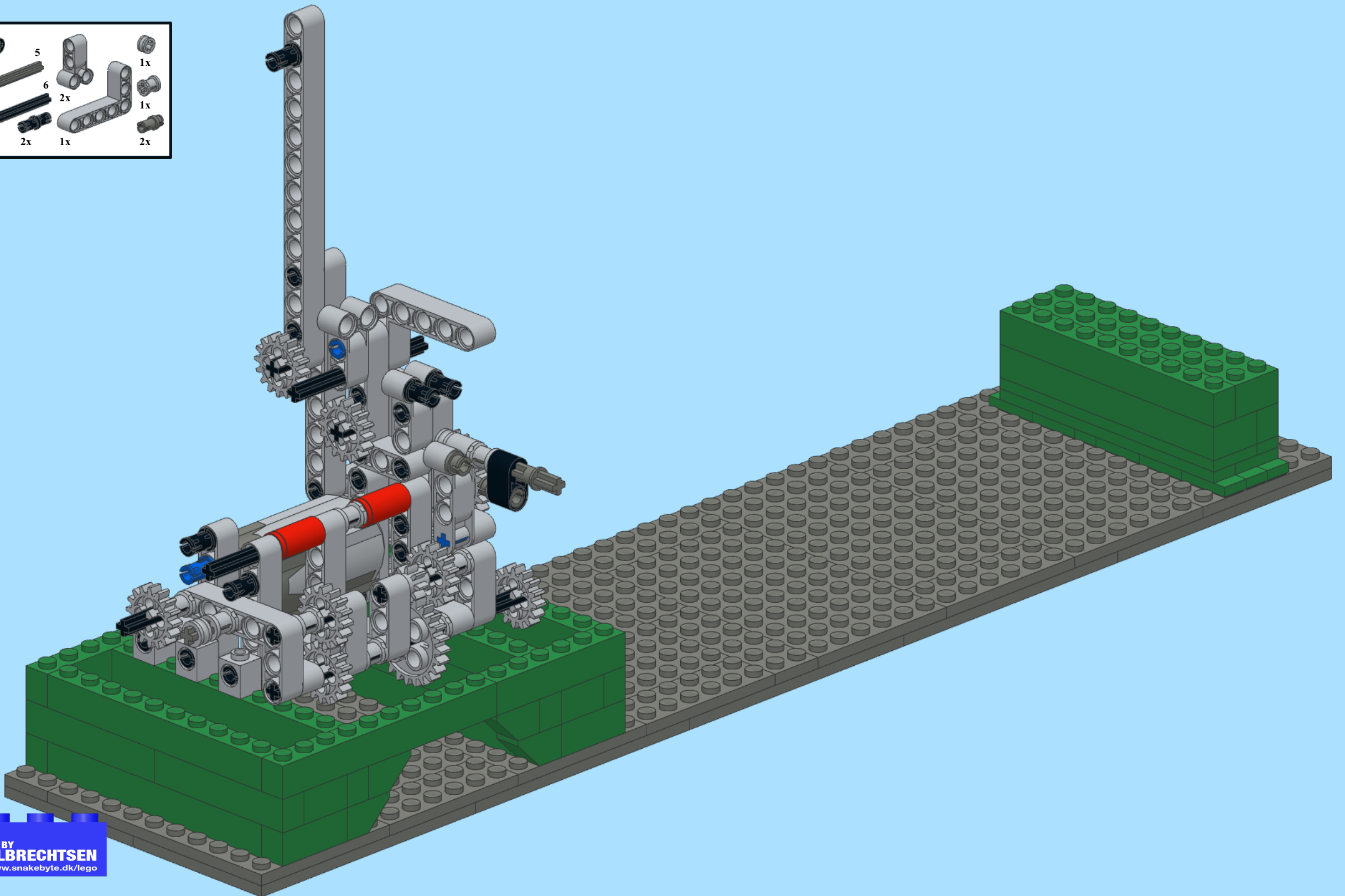
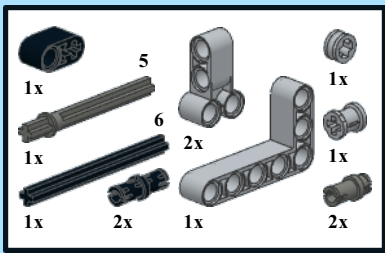

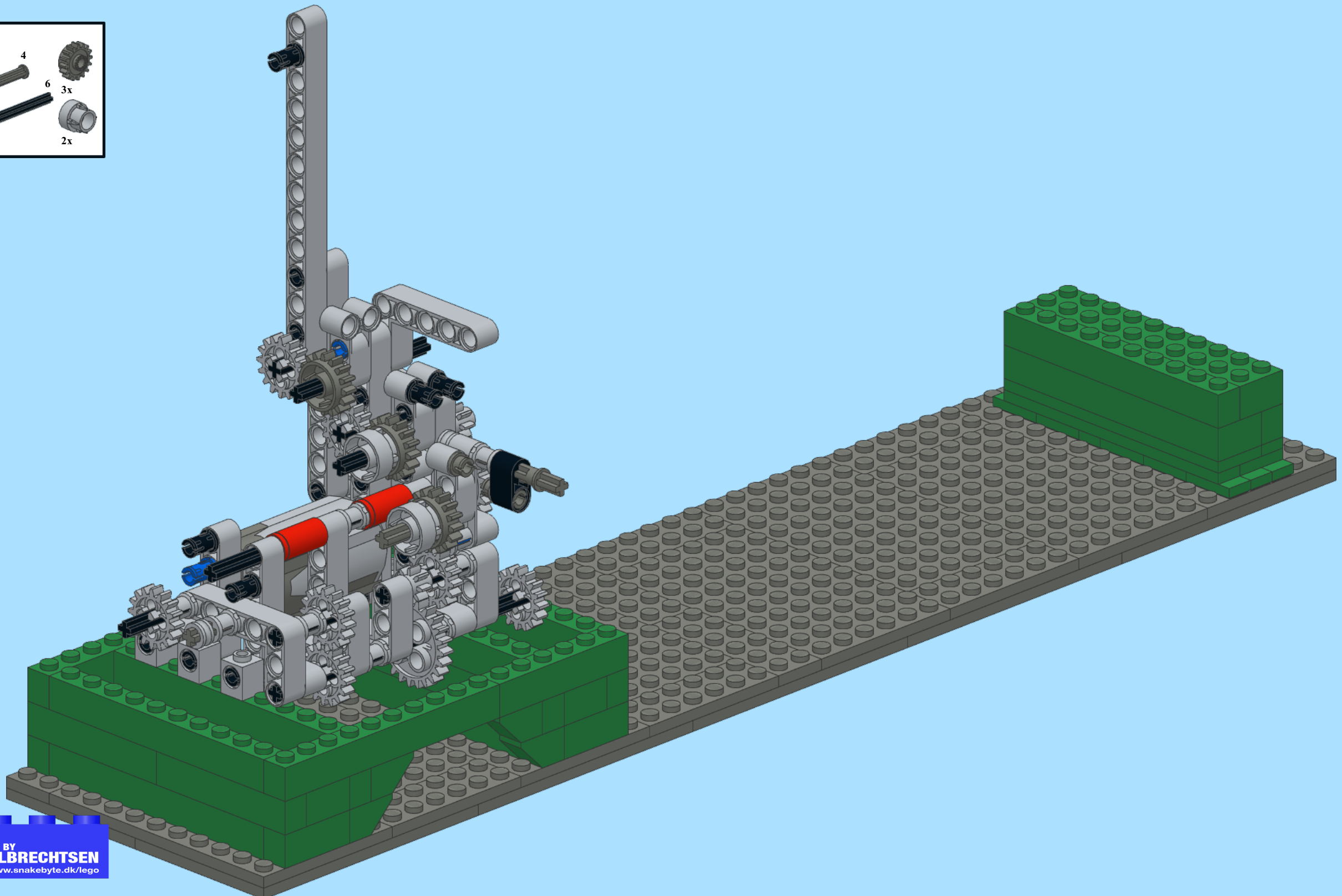
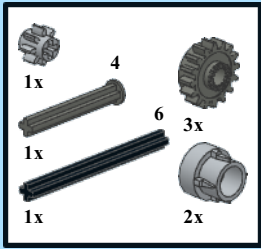

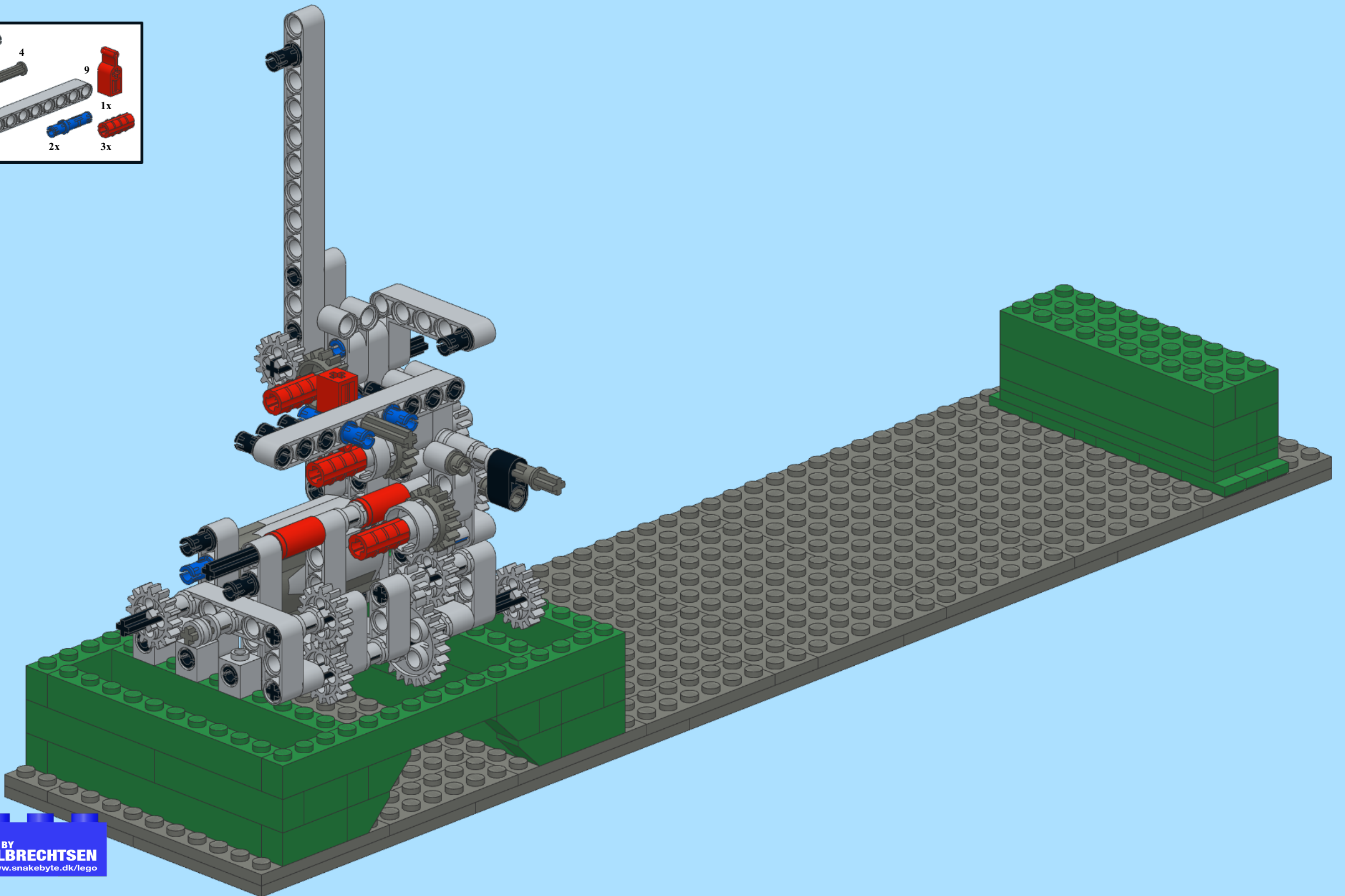
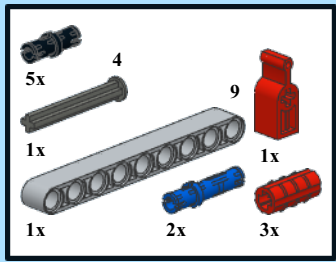

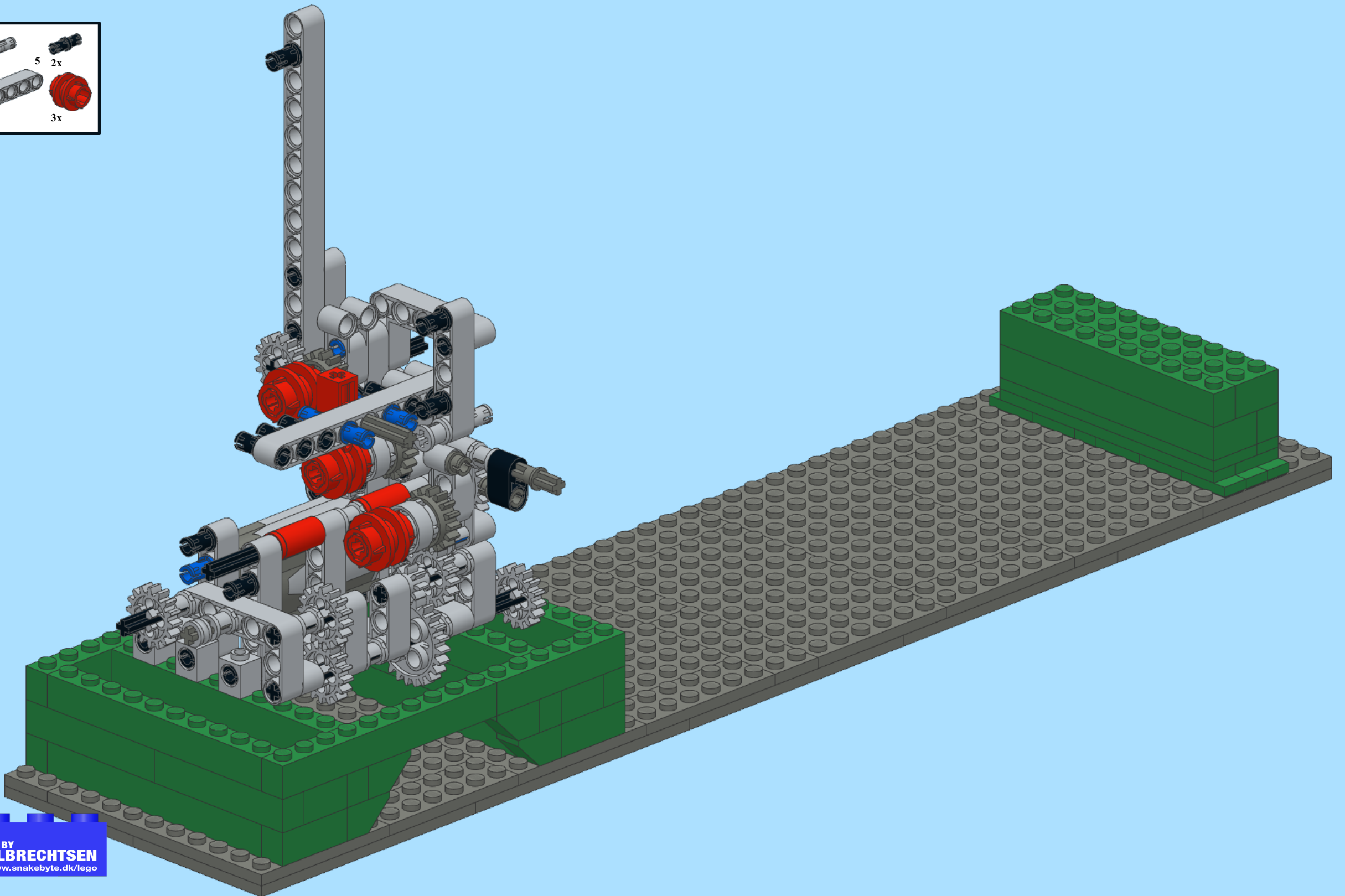
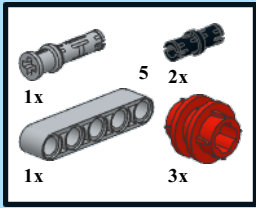

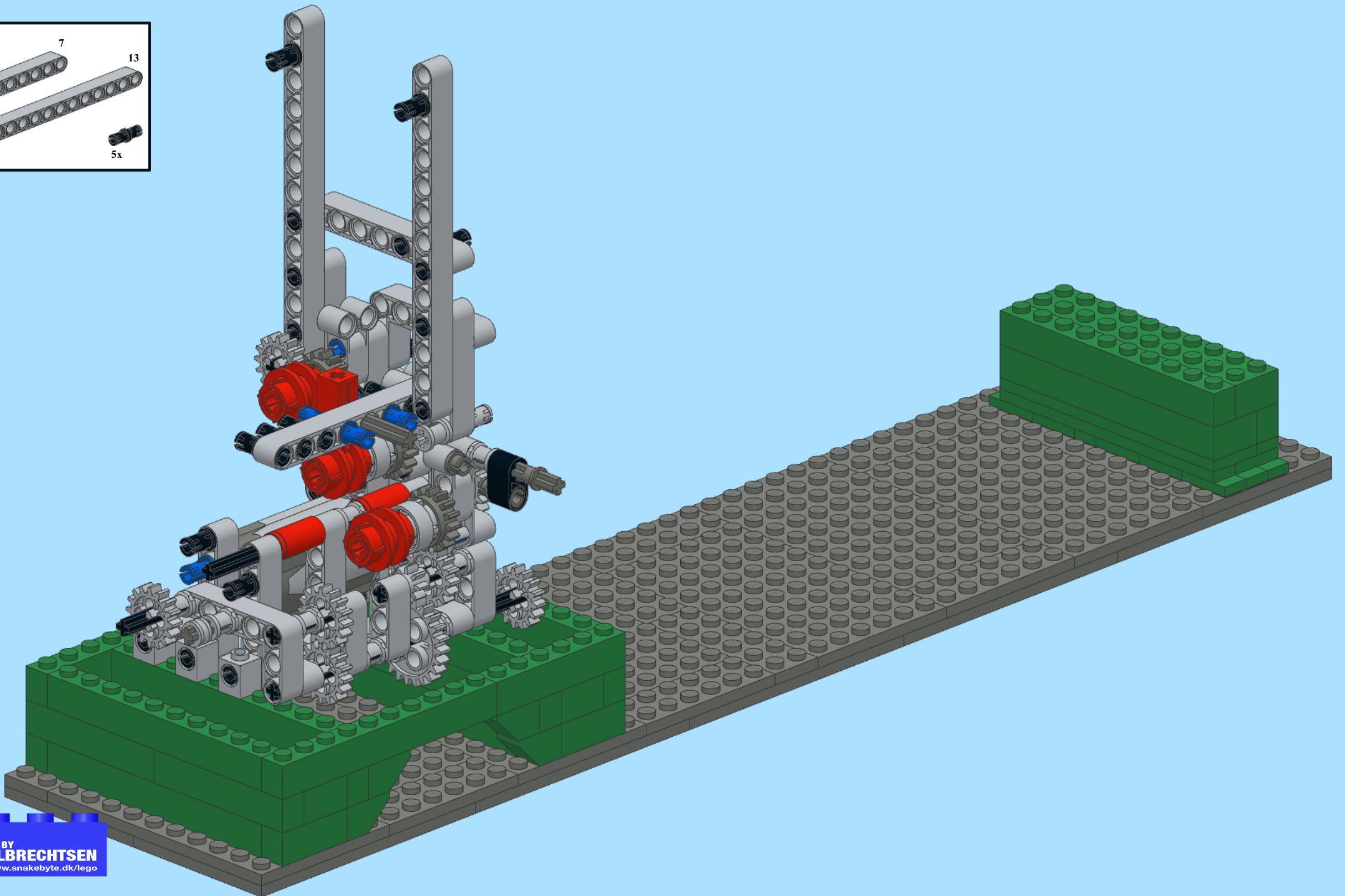
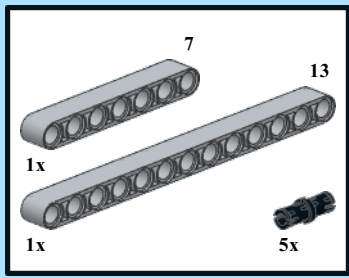

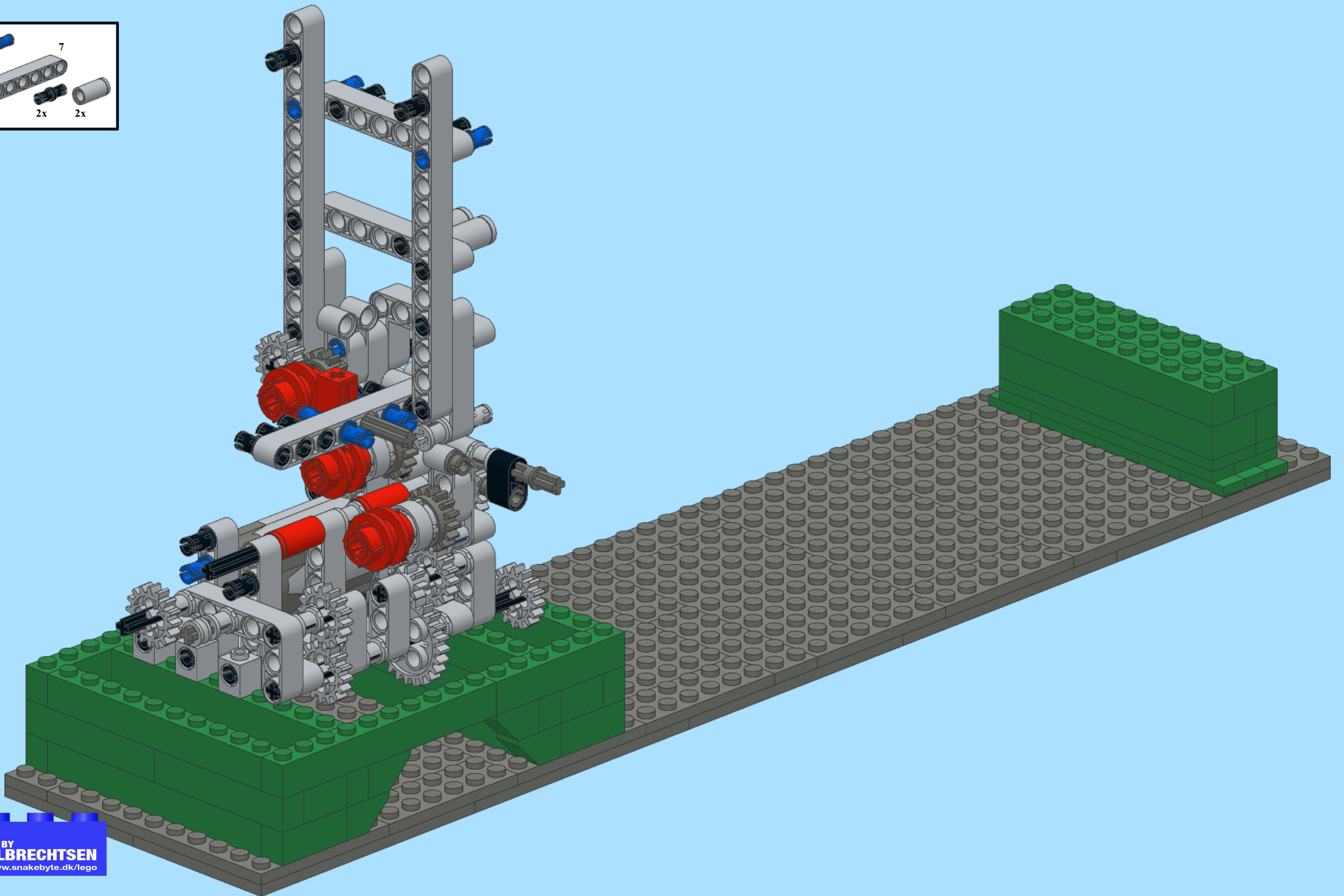
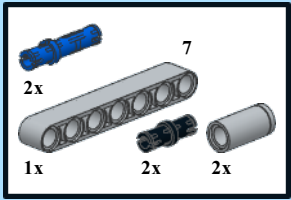

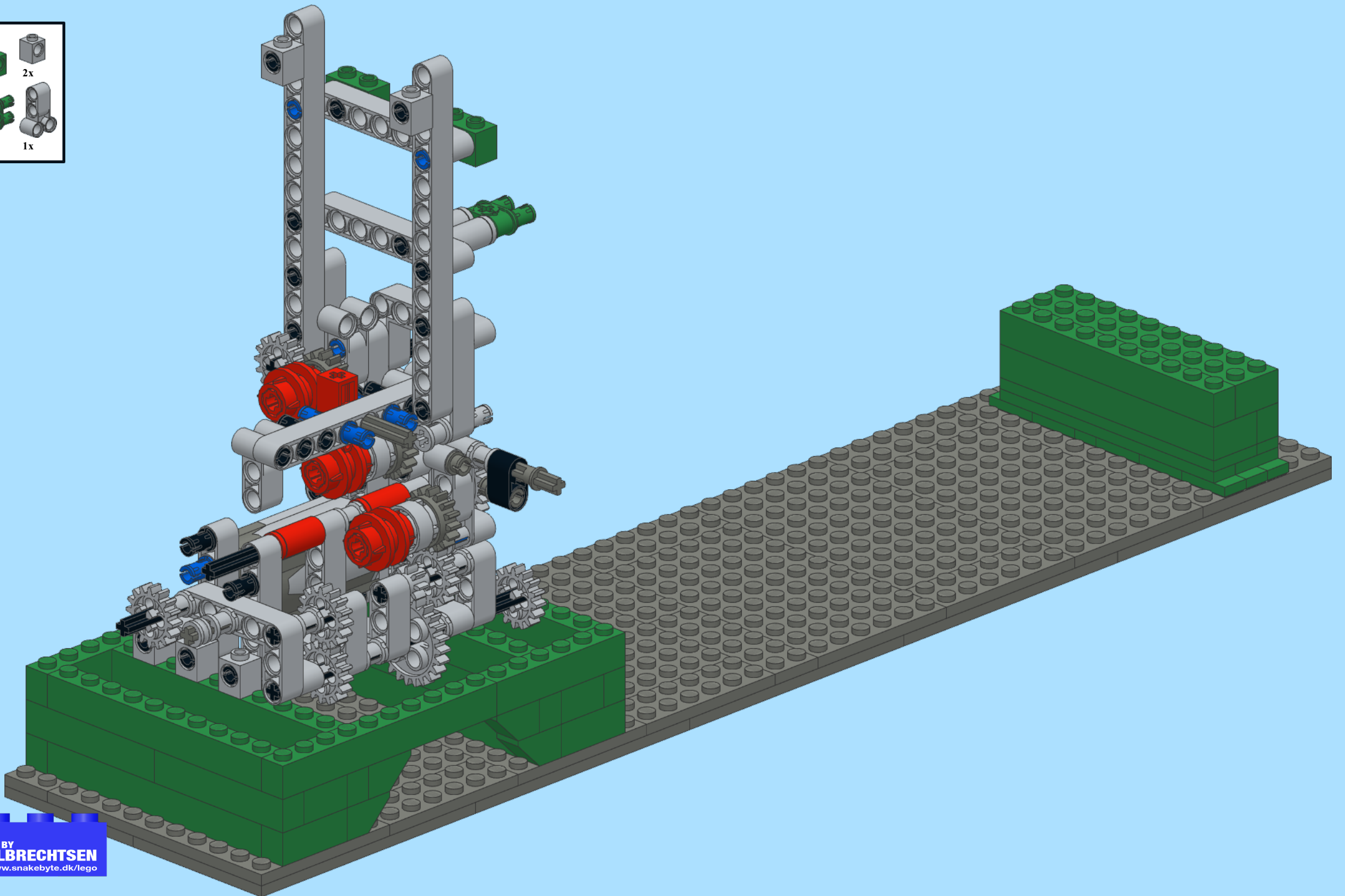
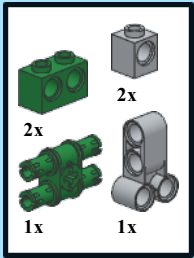



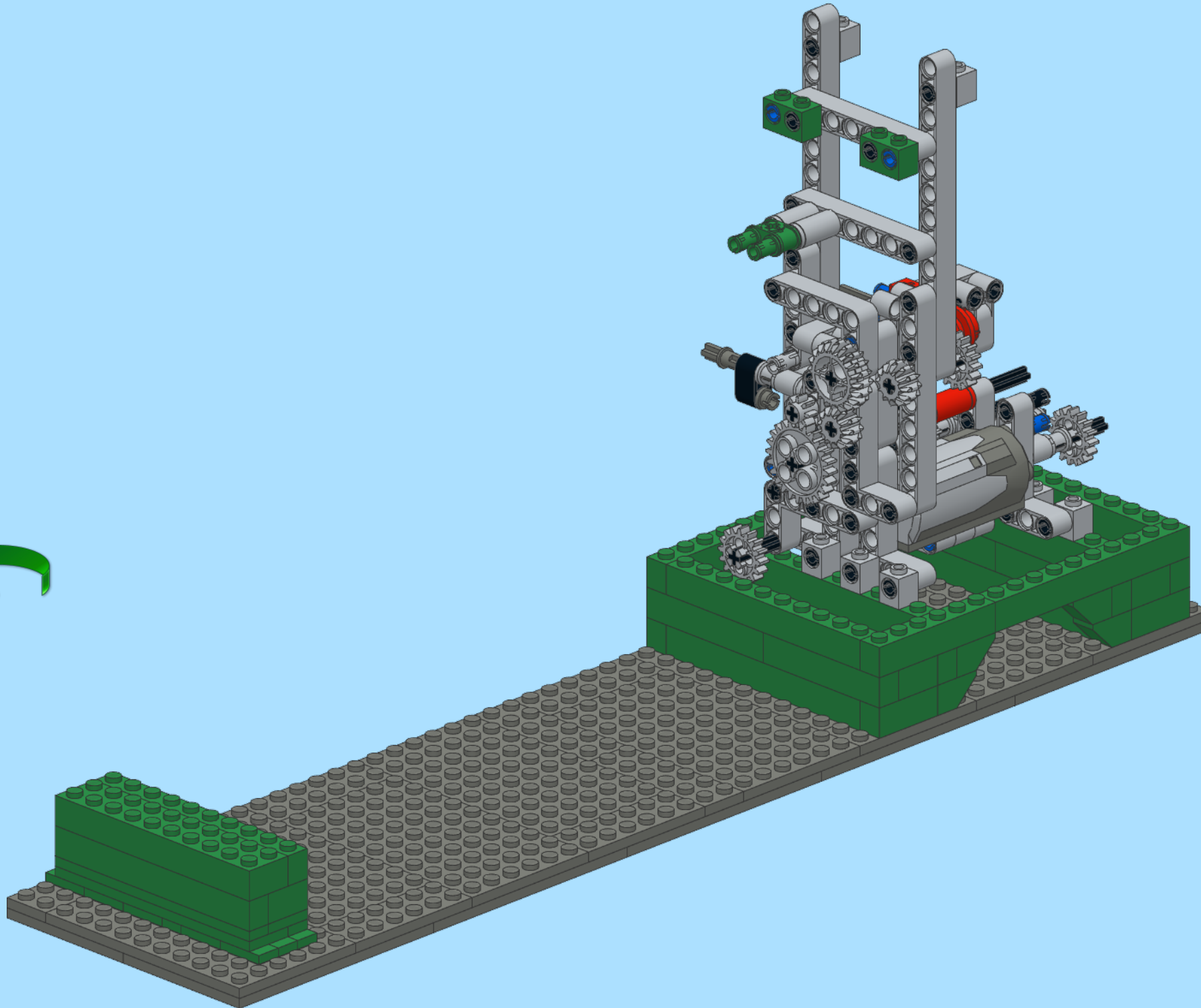

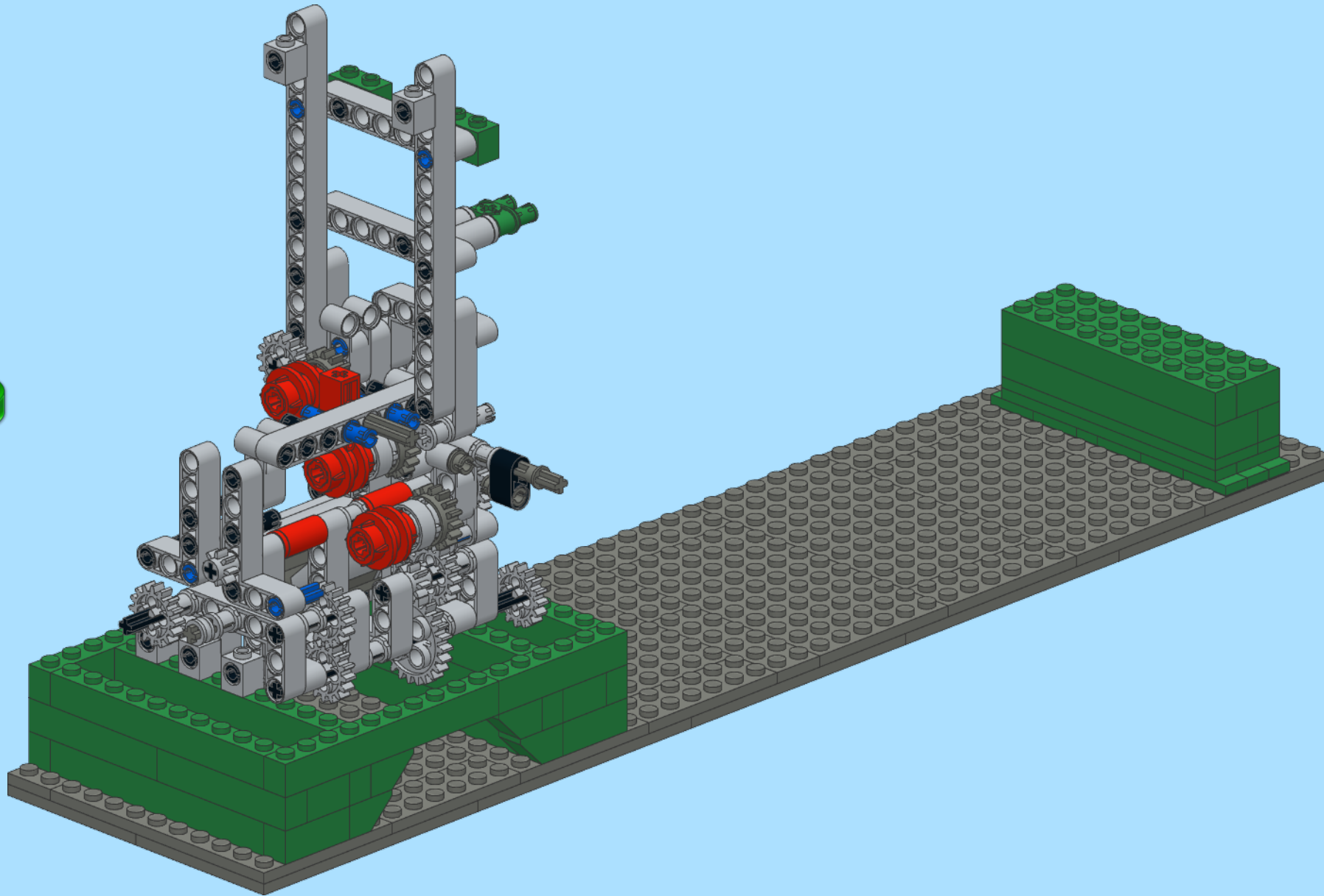
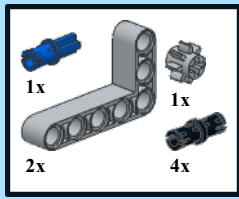

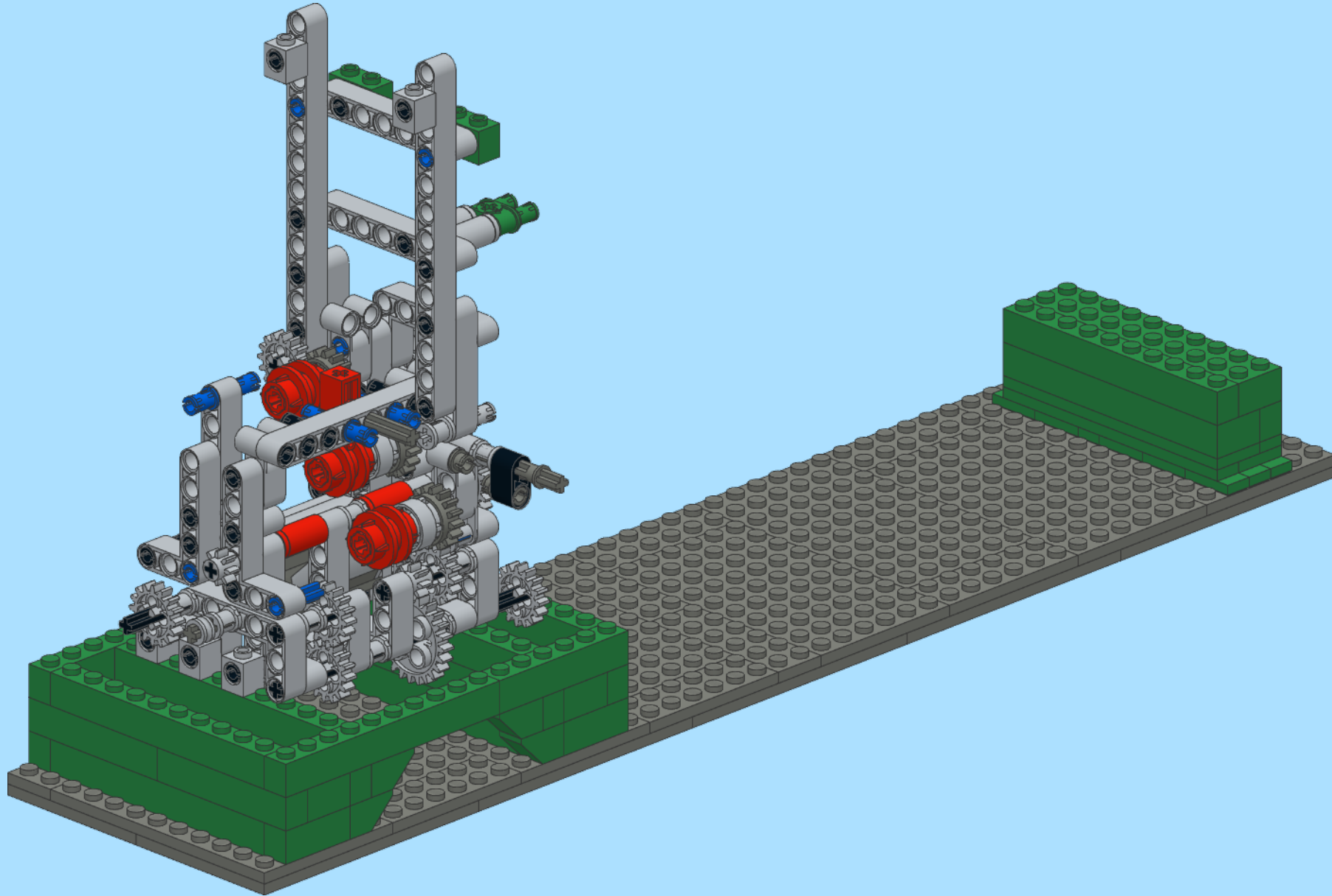
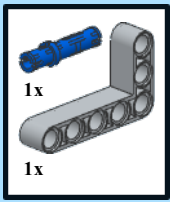

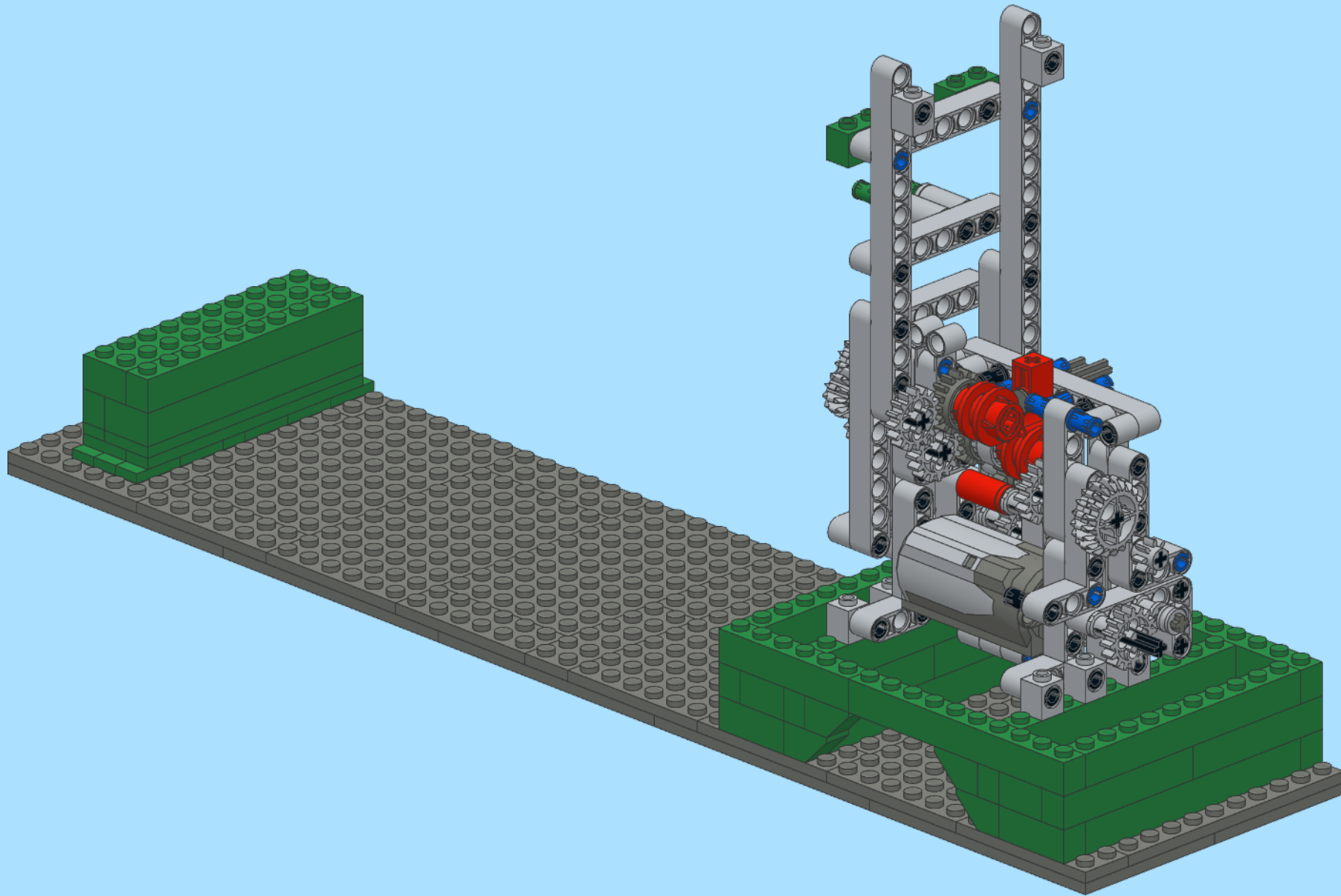

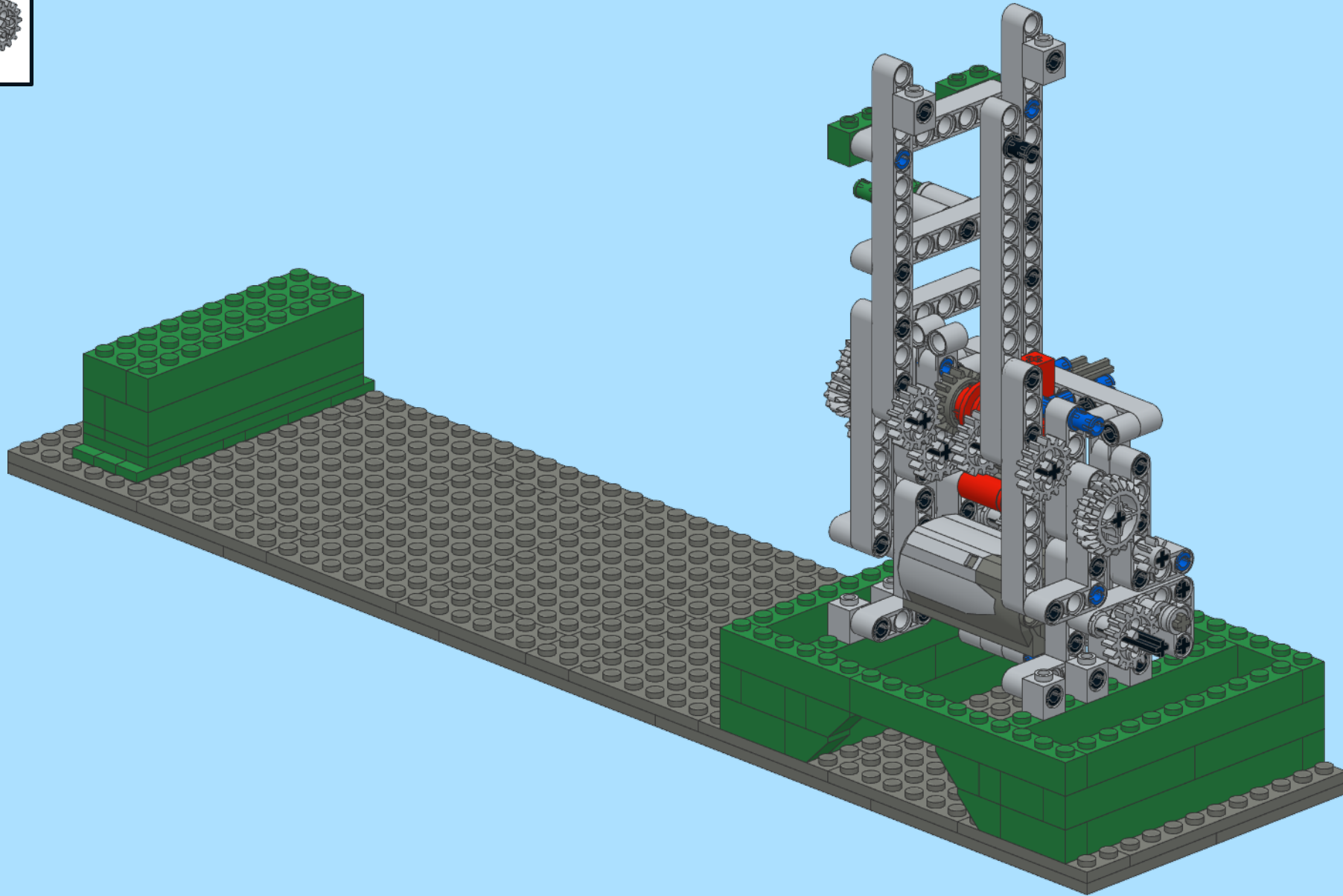
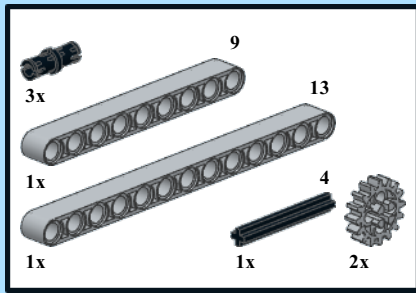

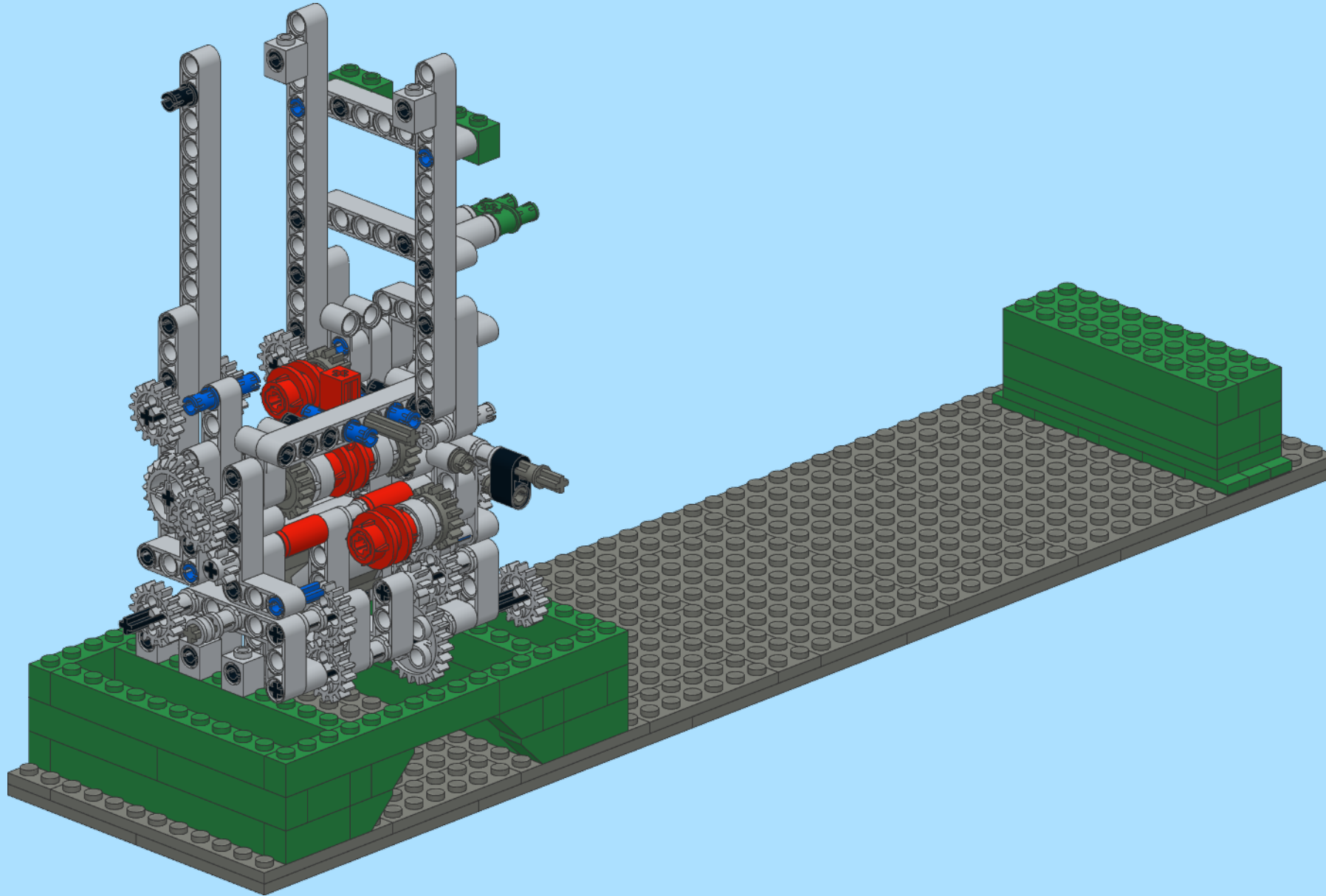
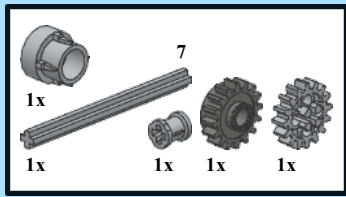

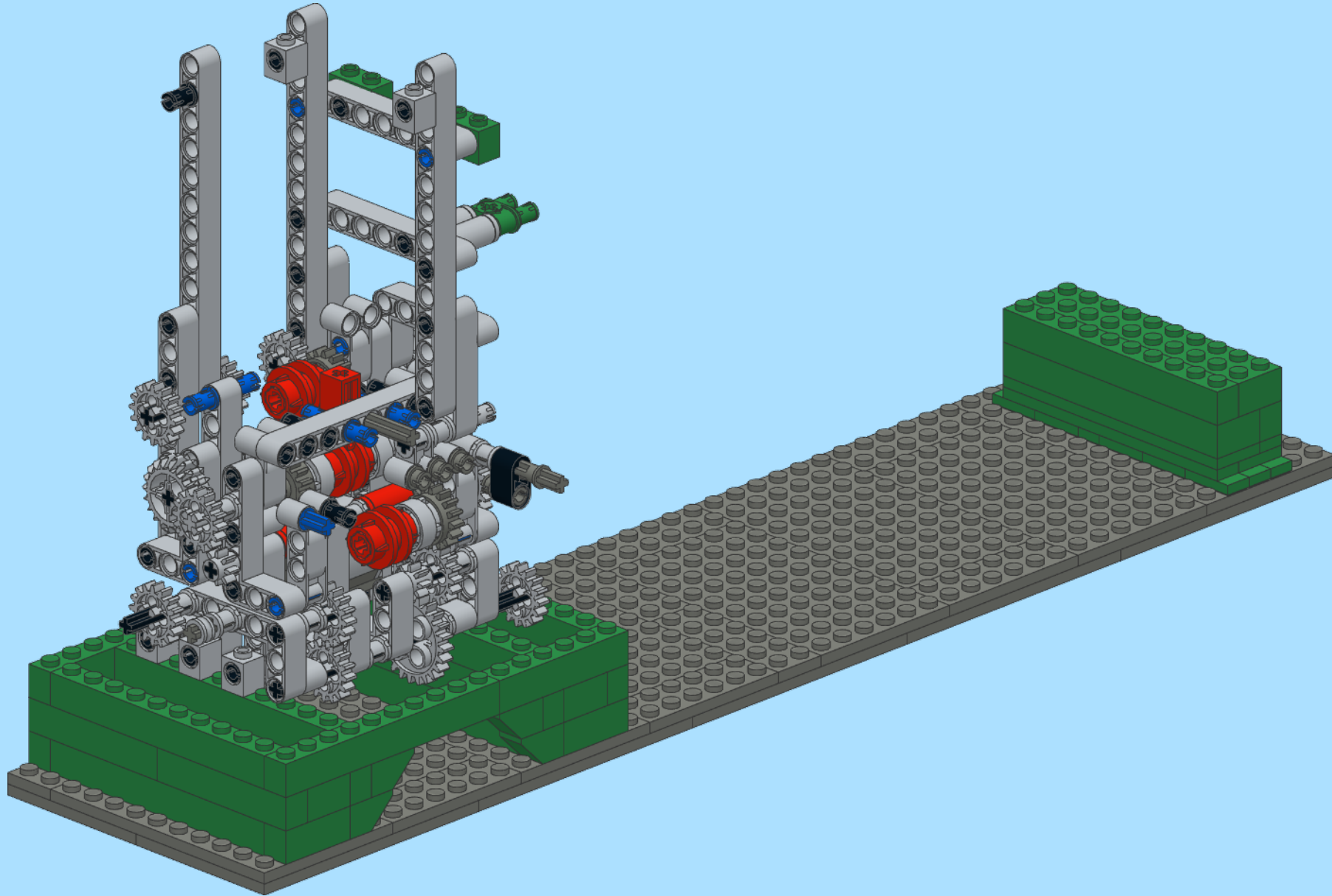
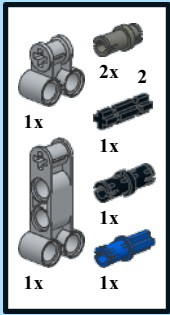

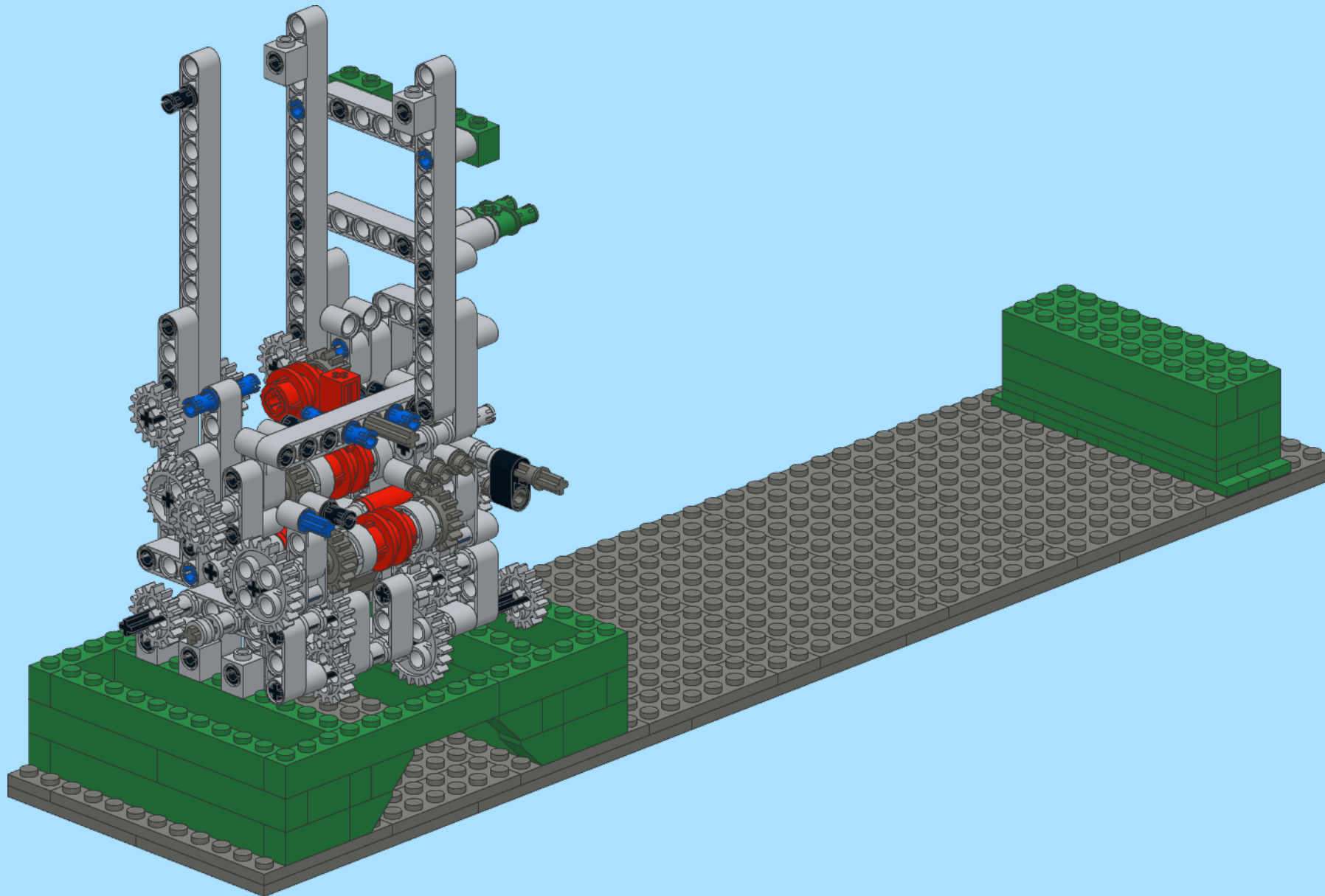
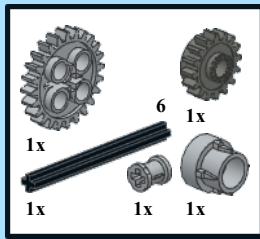



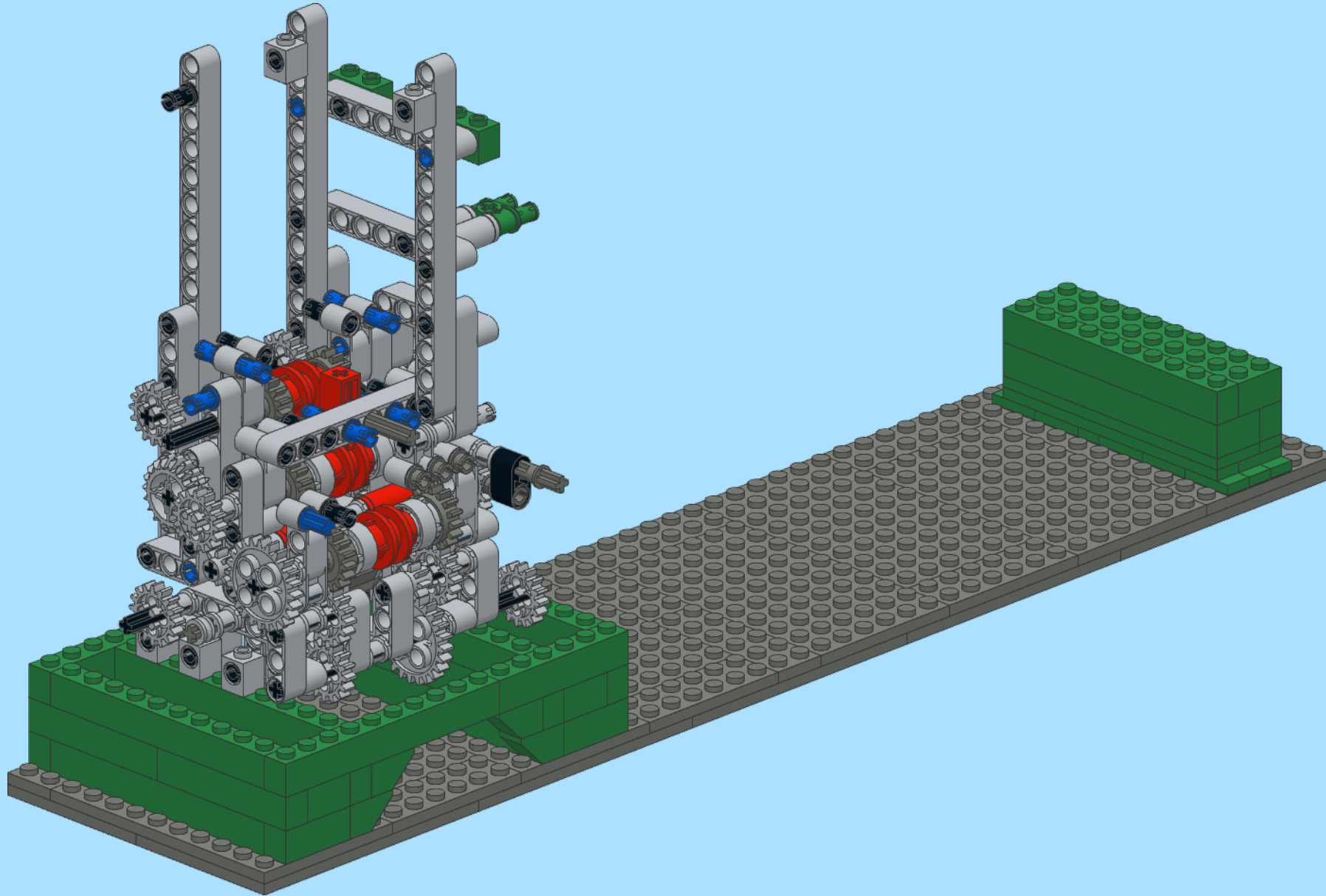

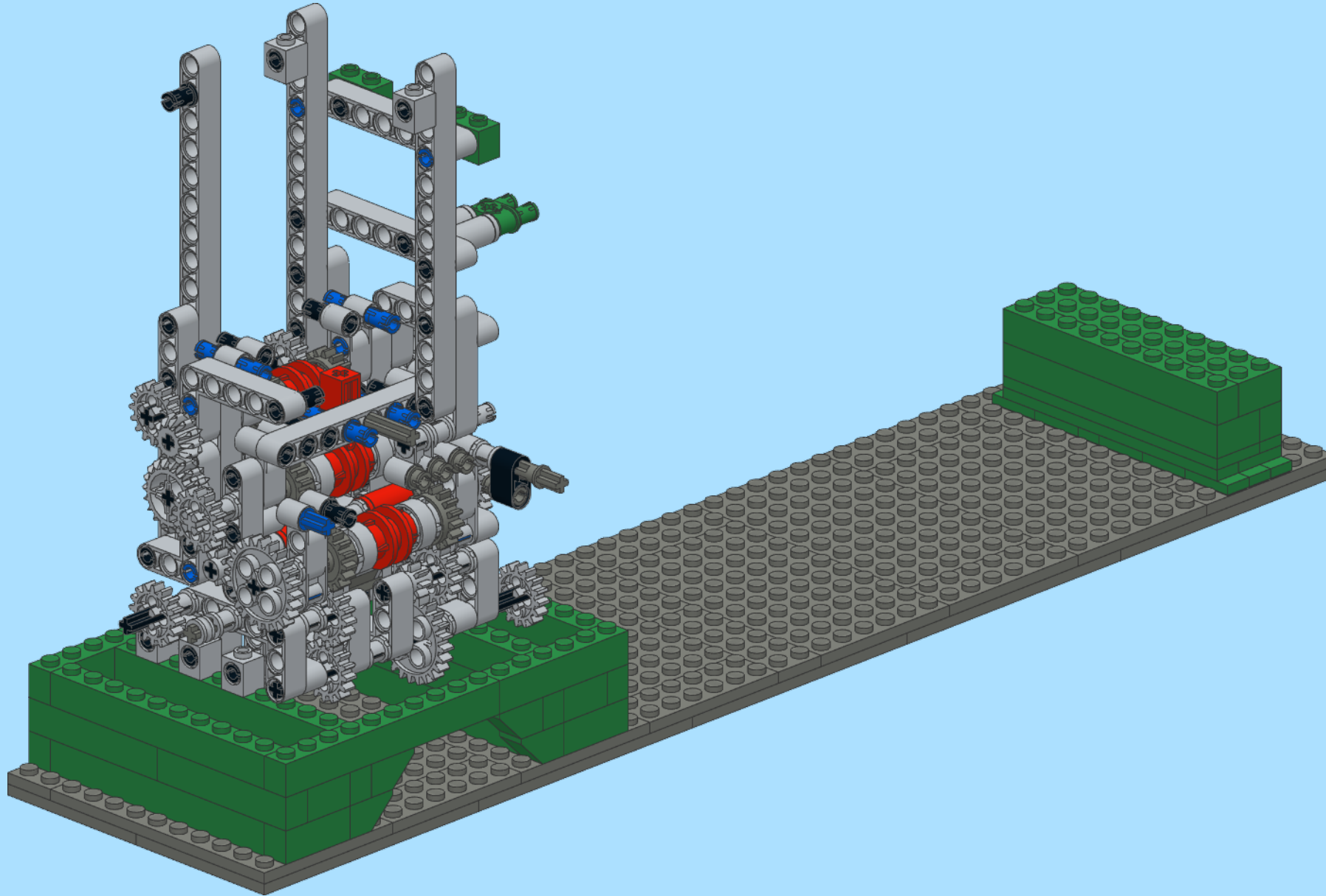
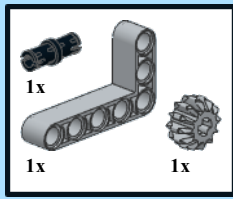

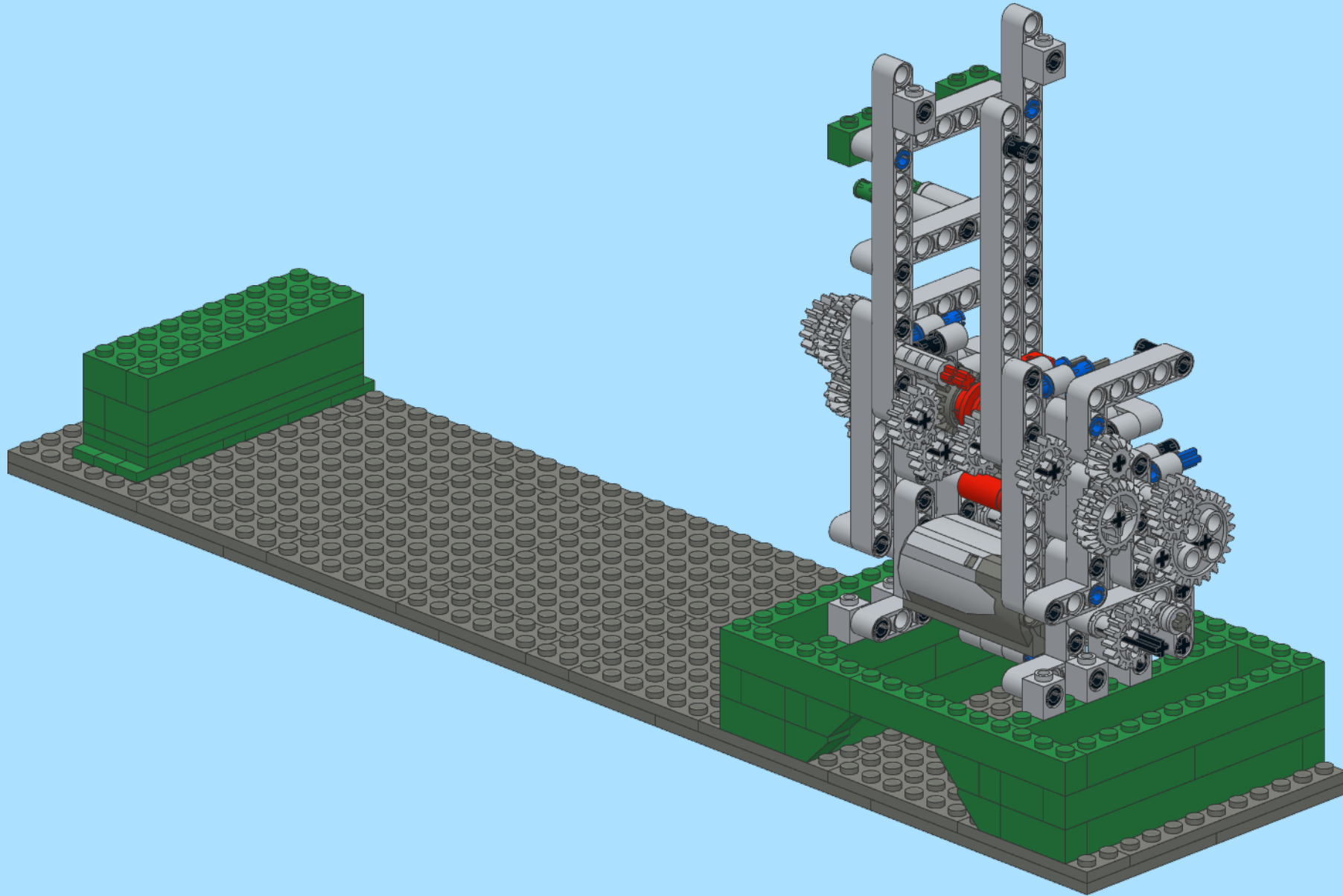
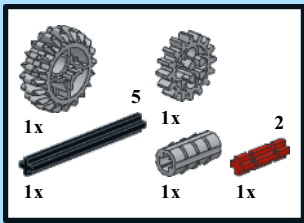

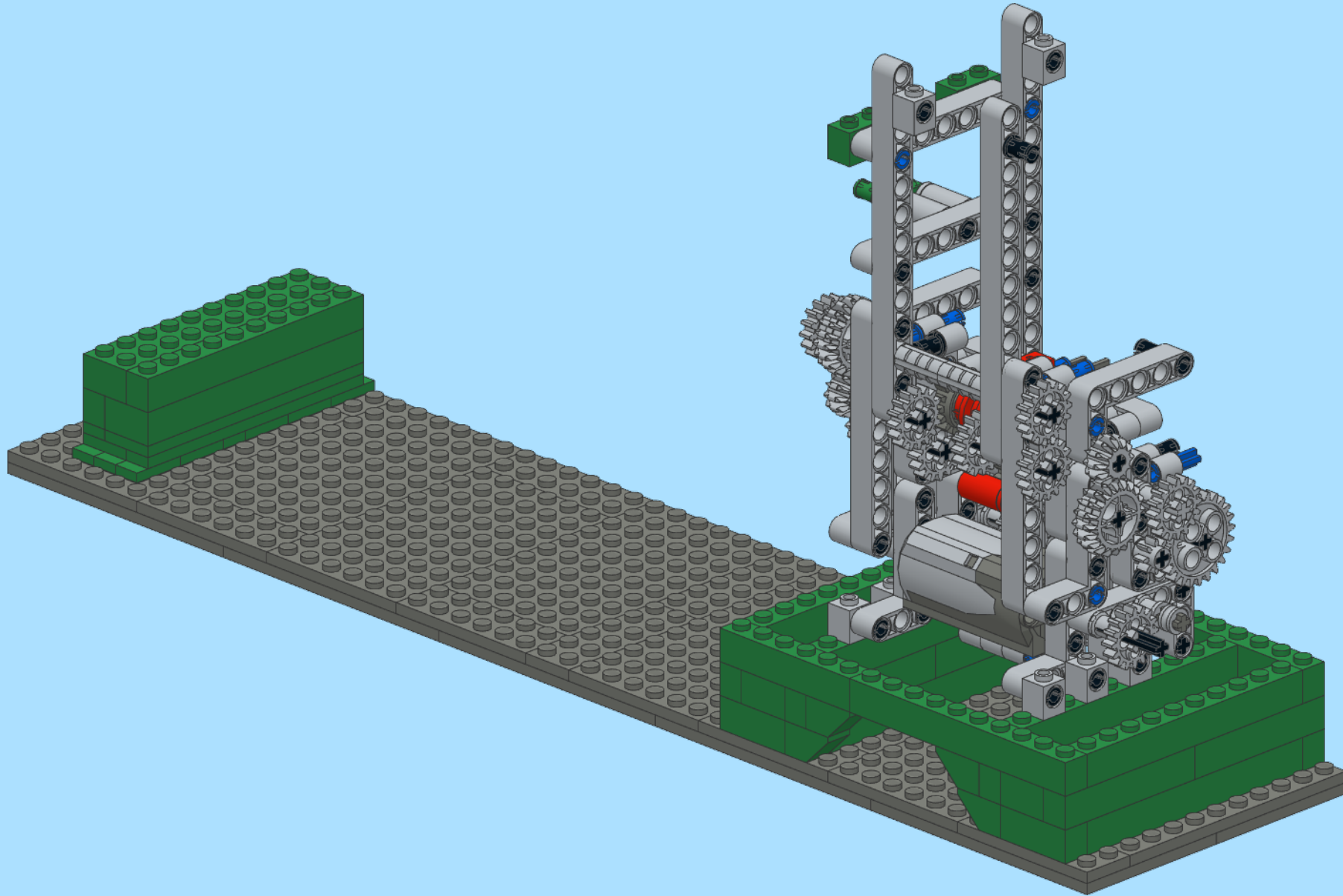
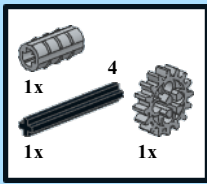

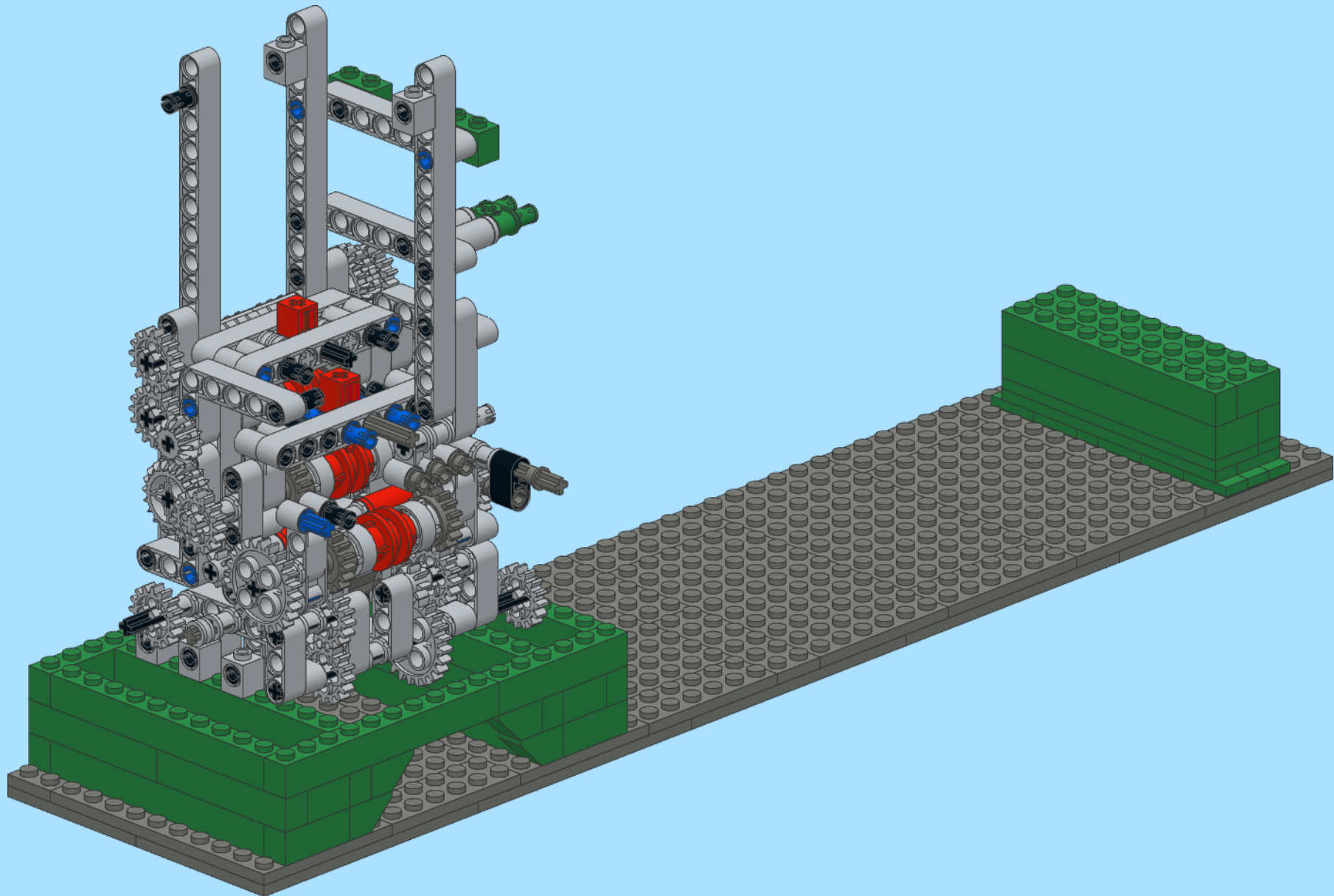
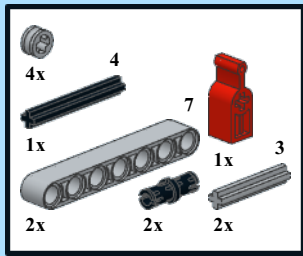

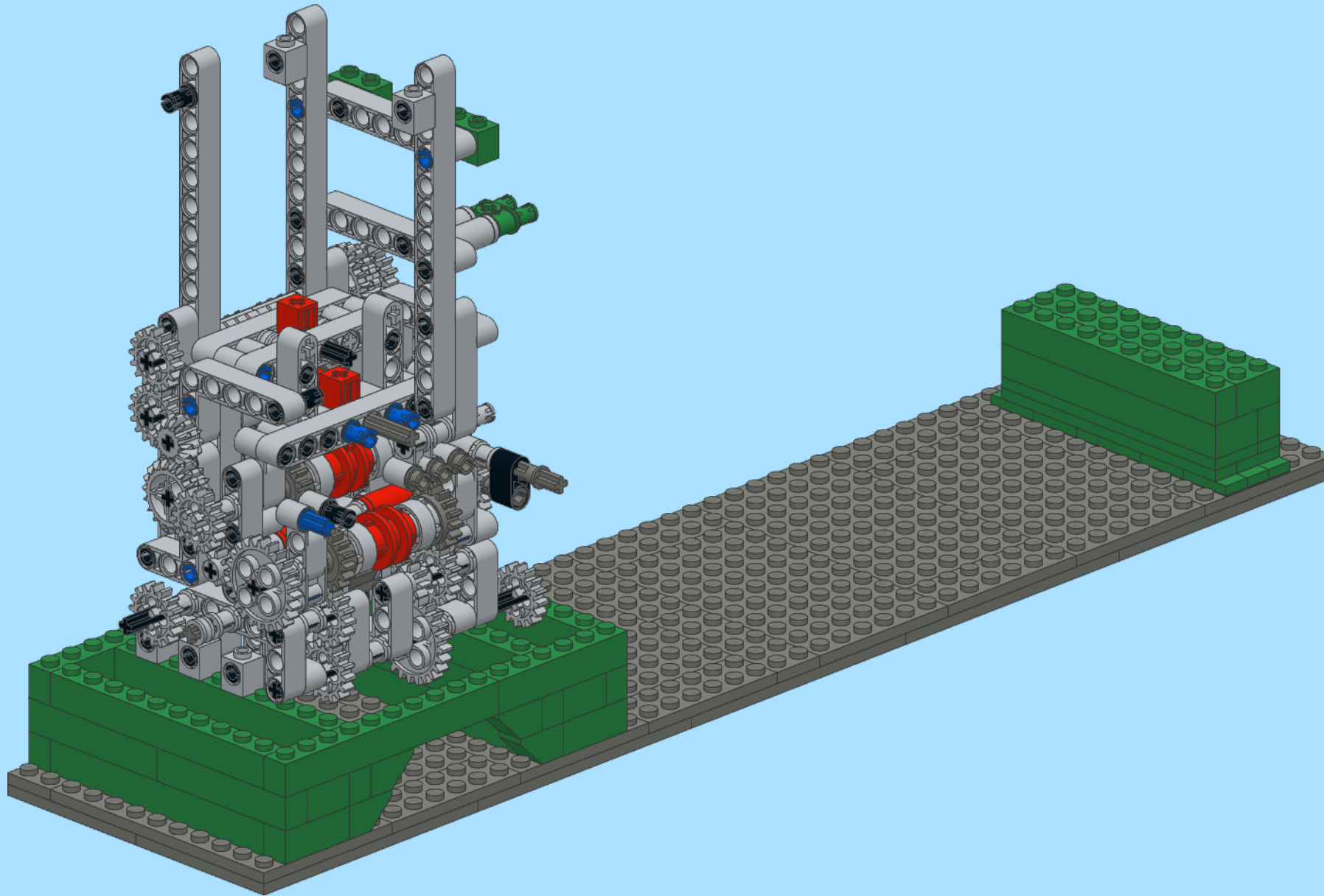
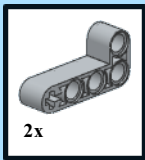

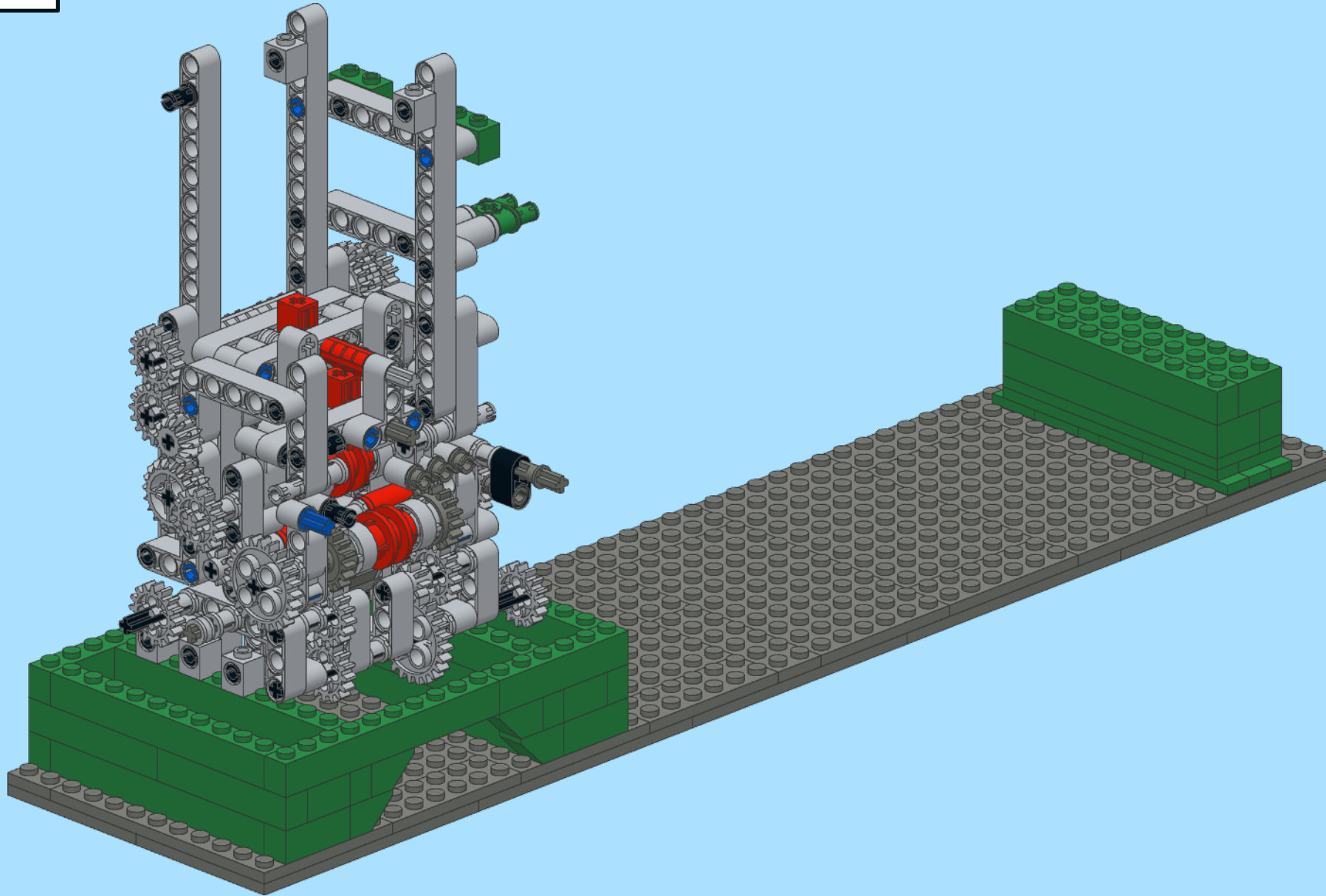
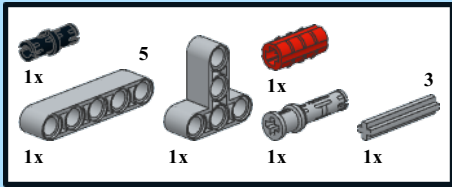





-  1x 2
-  1x
-  1x
-  1x

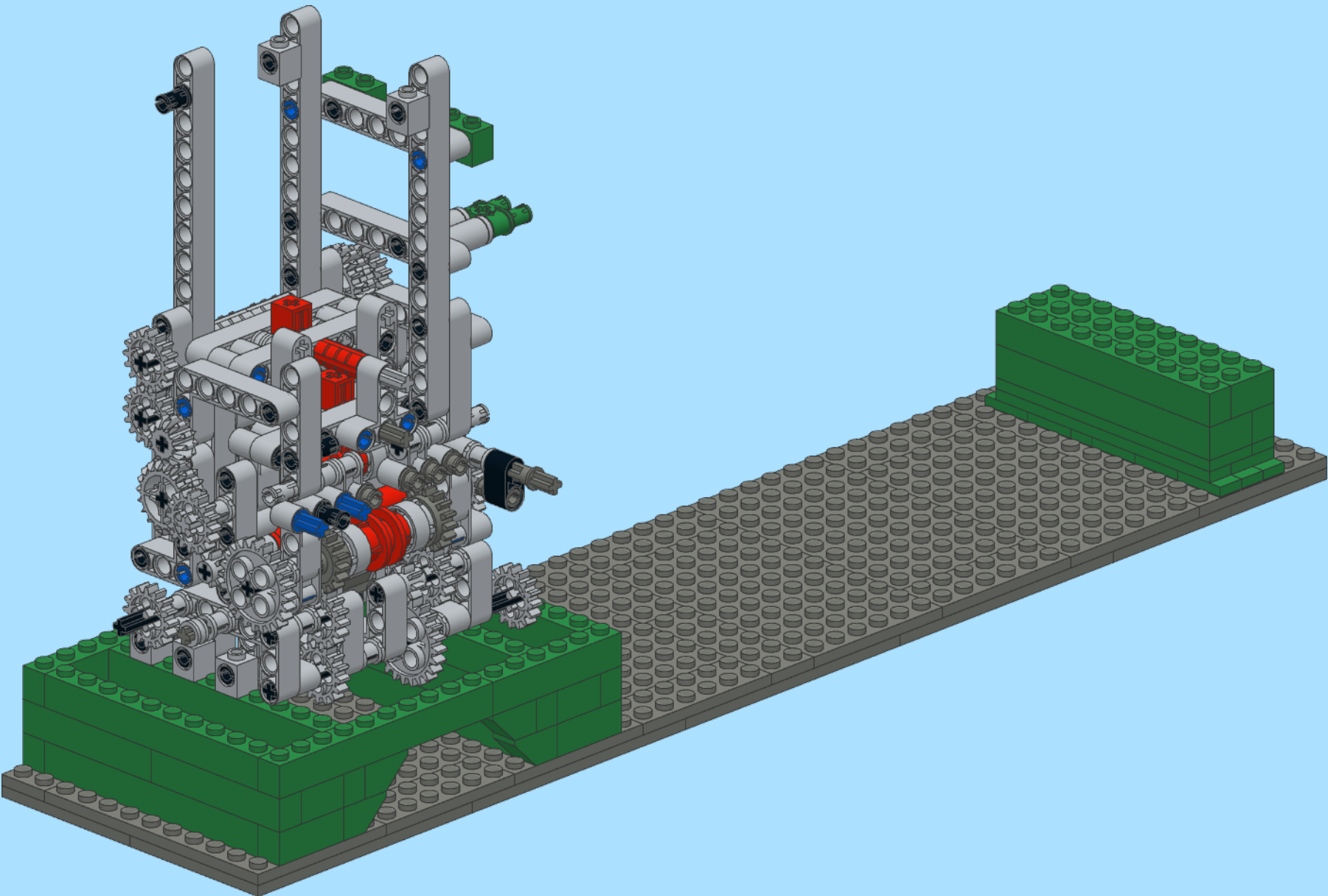



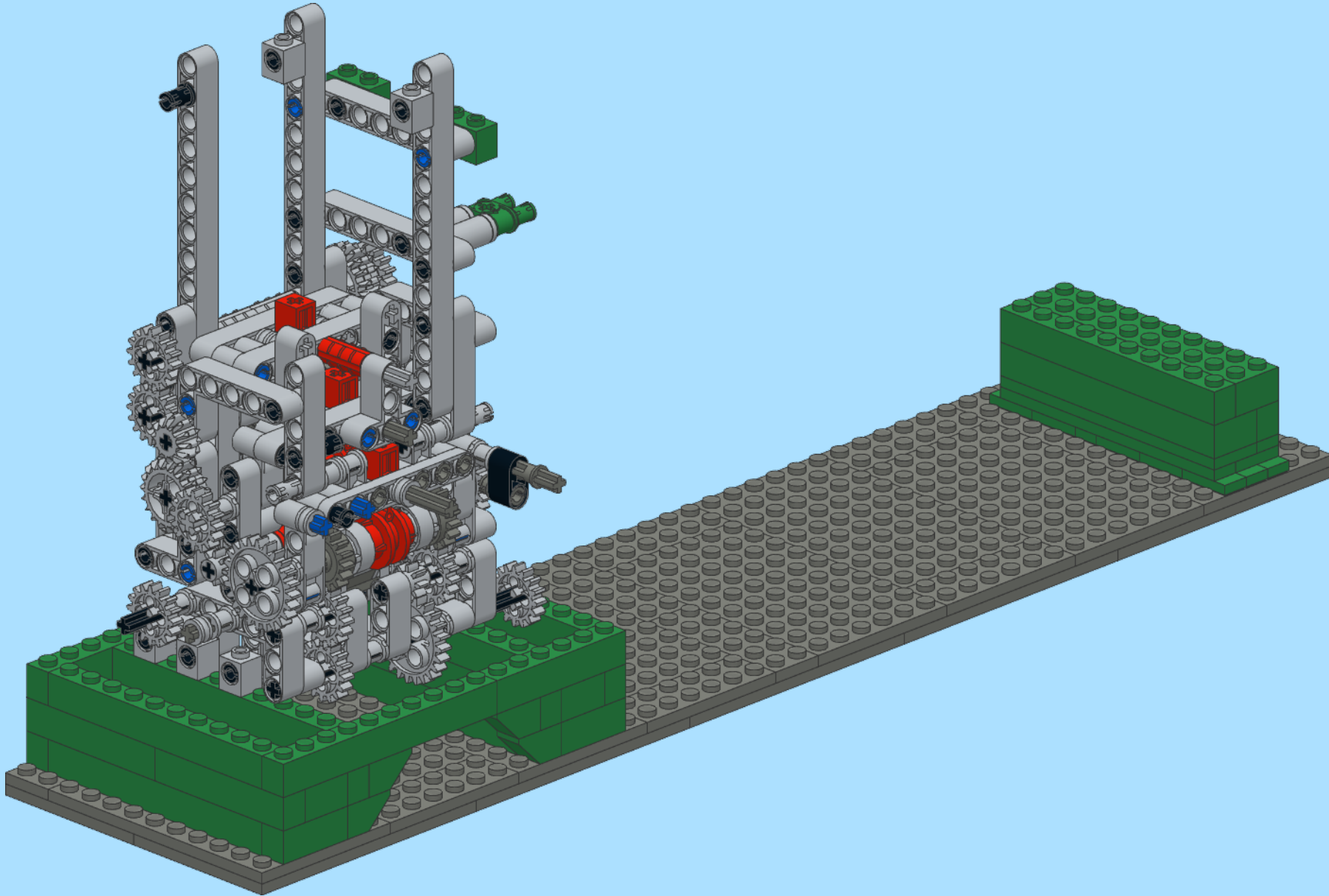
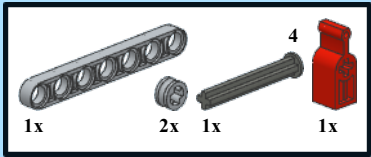

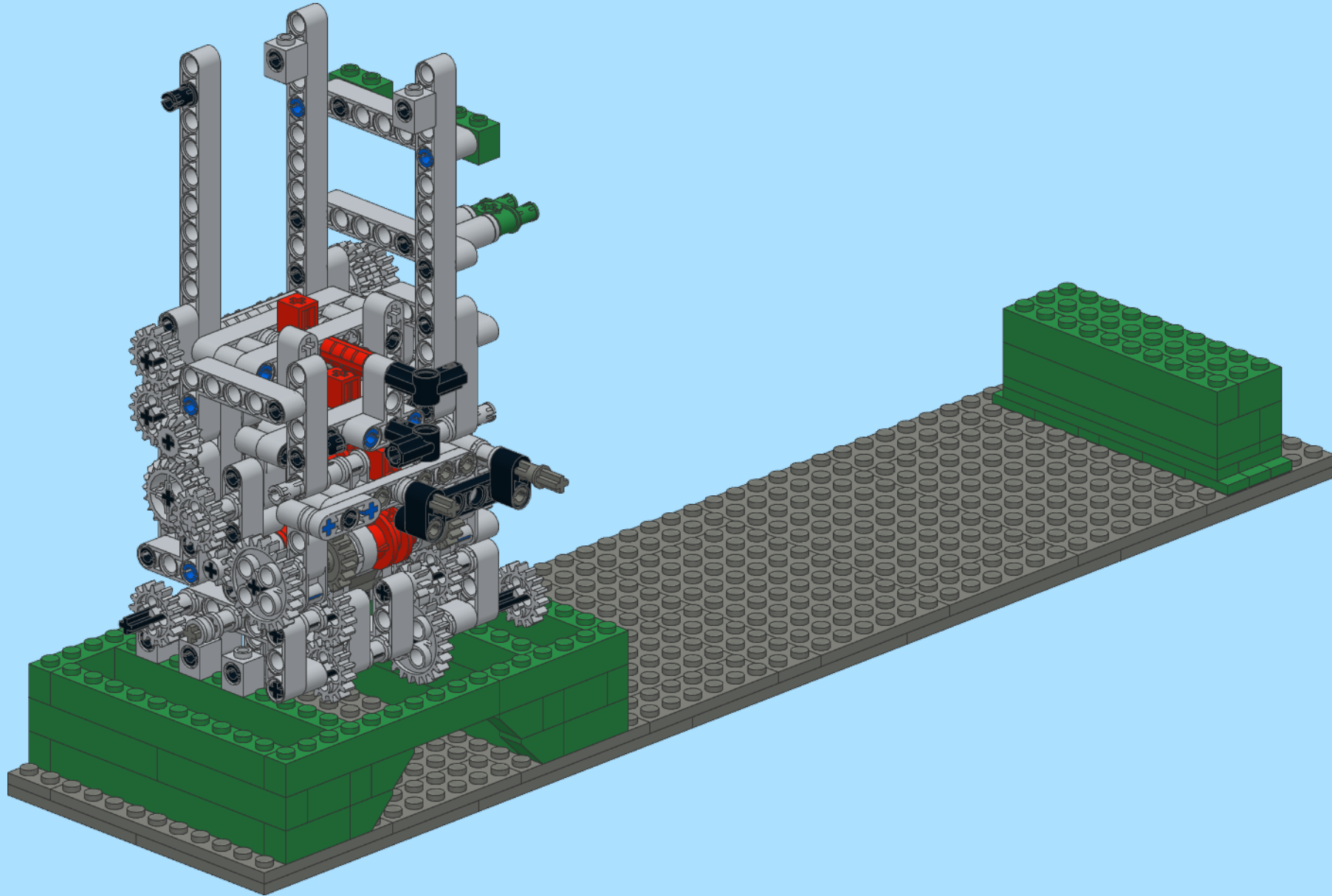
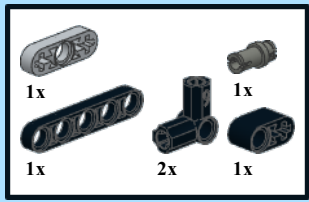

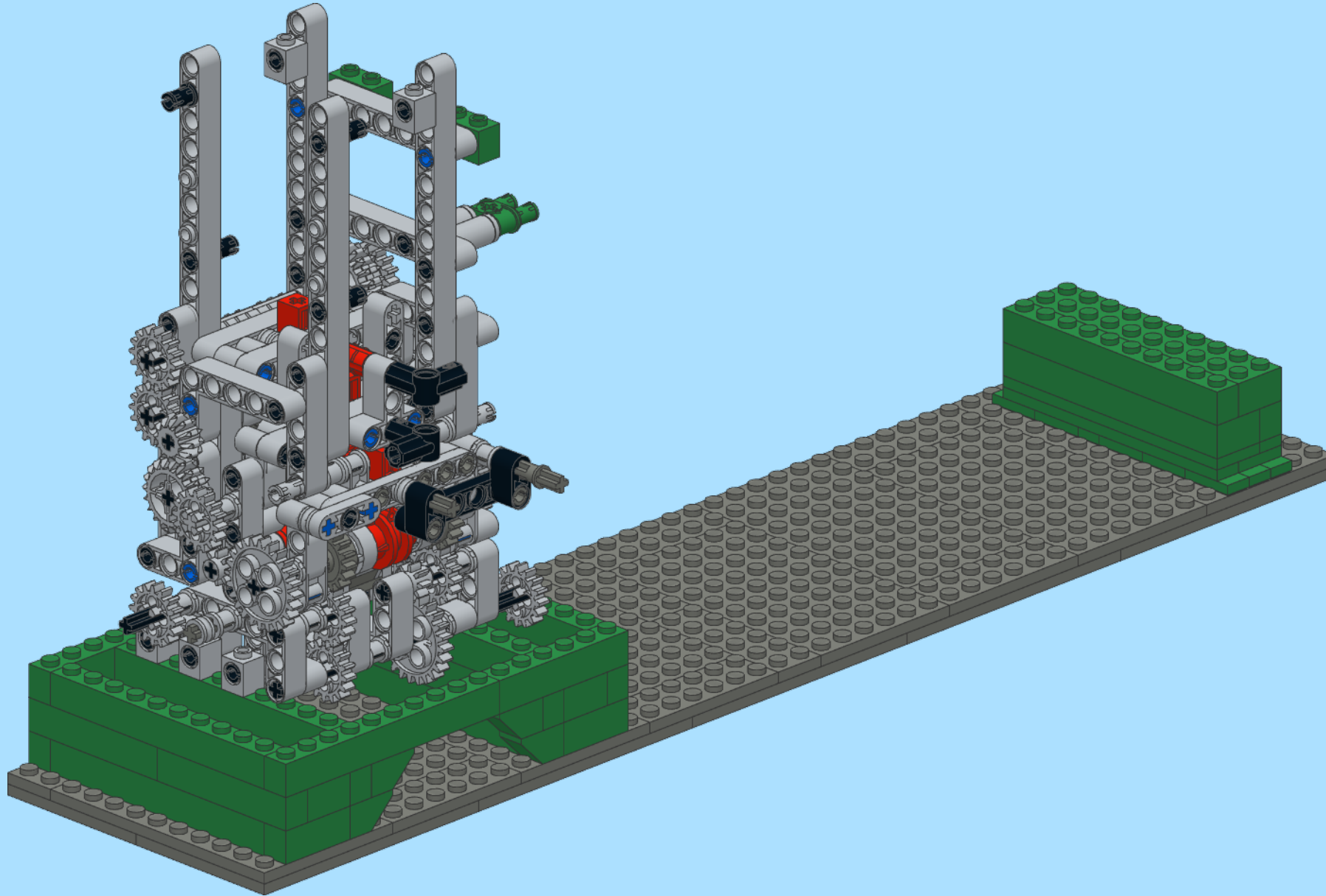
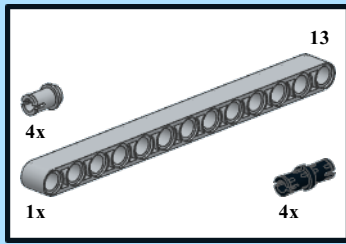

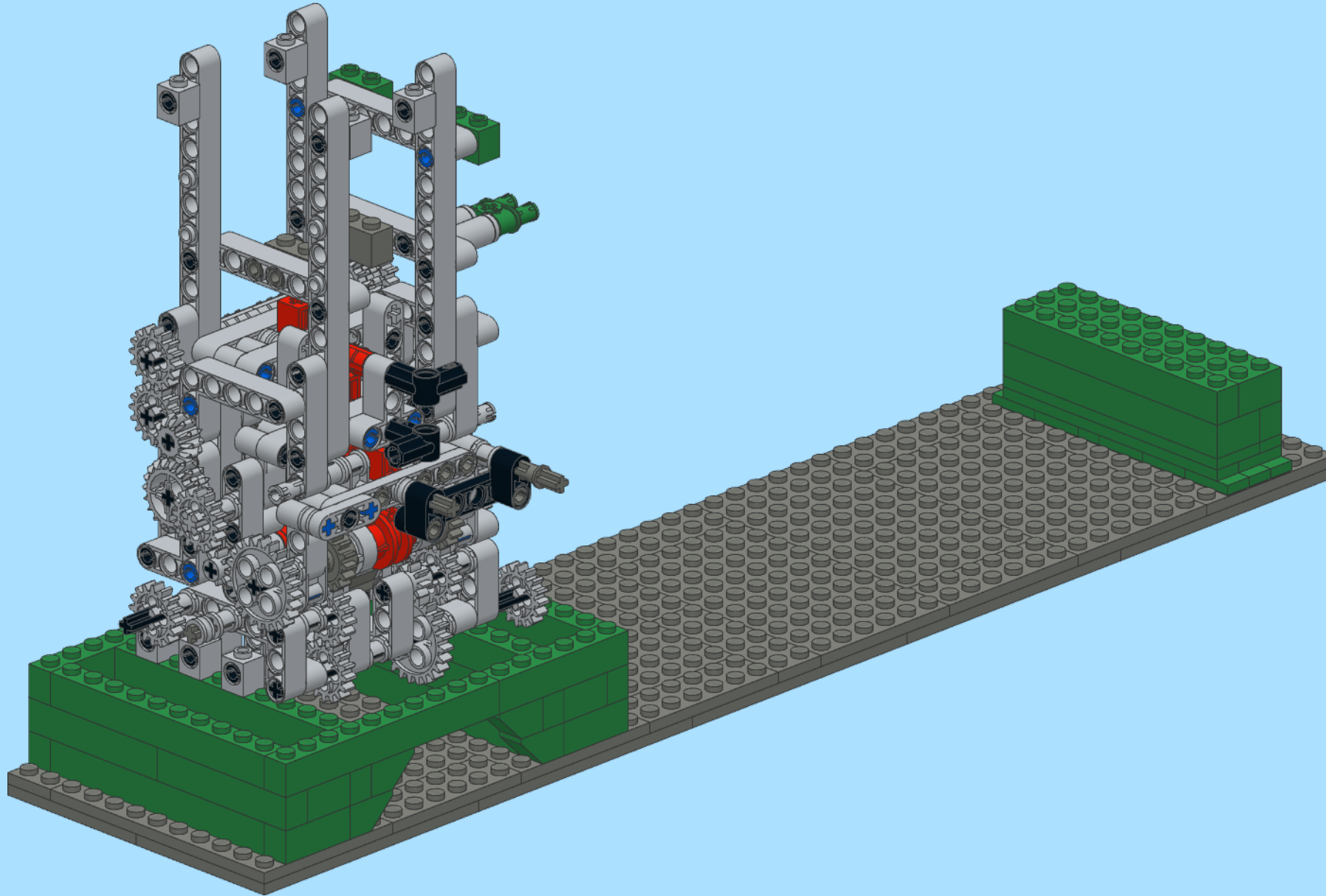
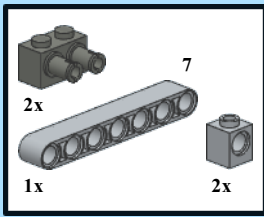

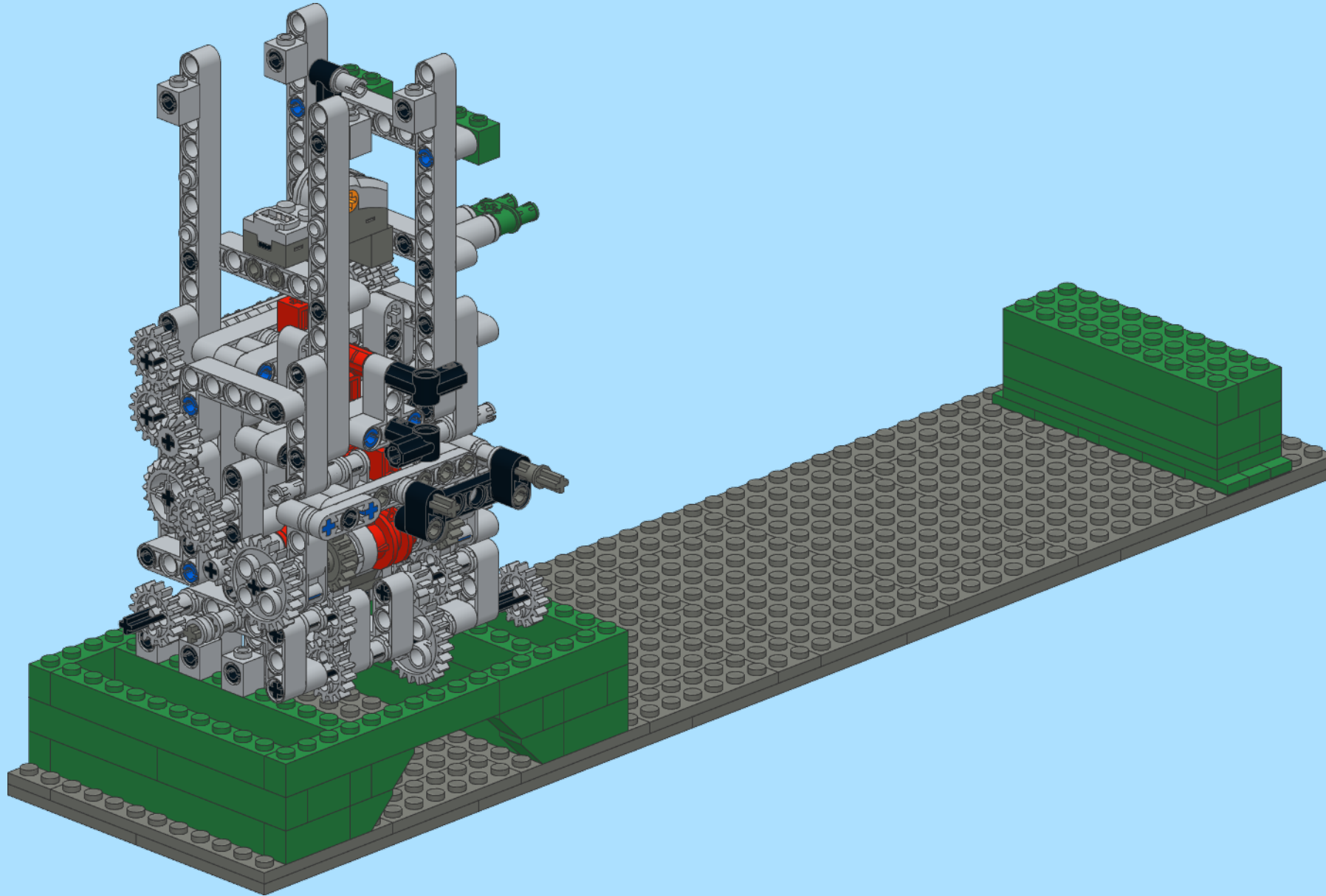
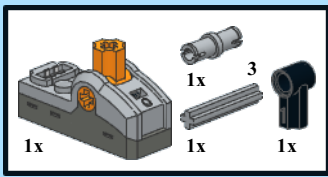

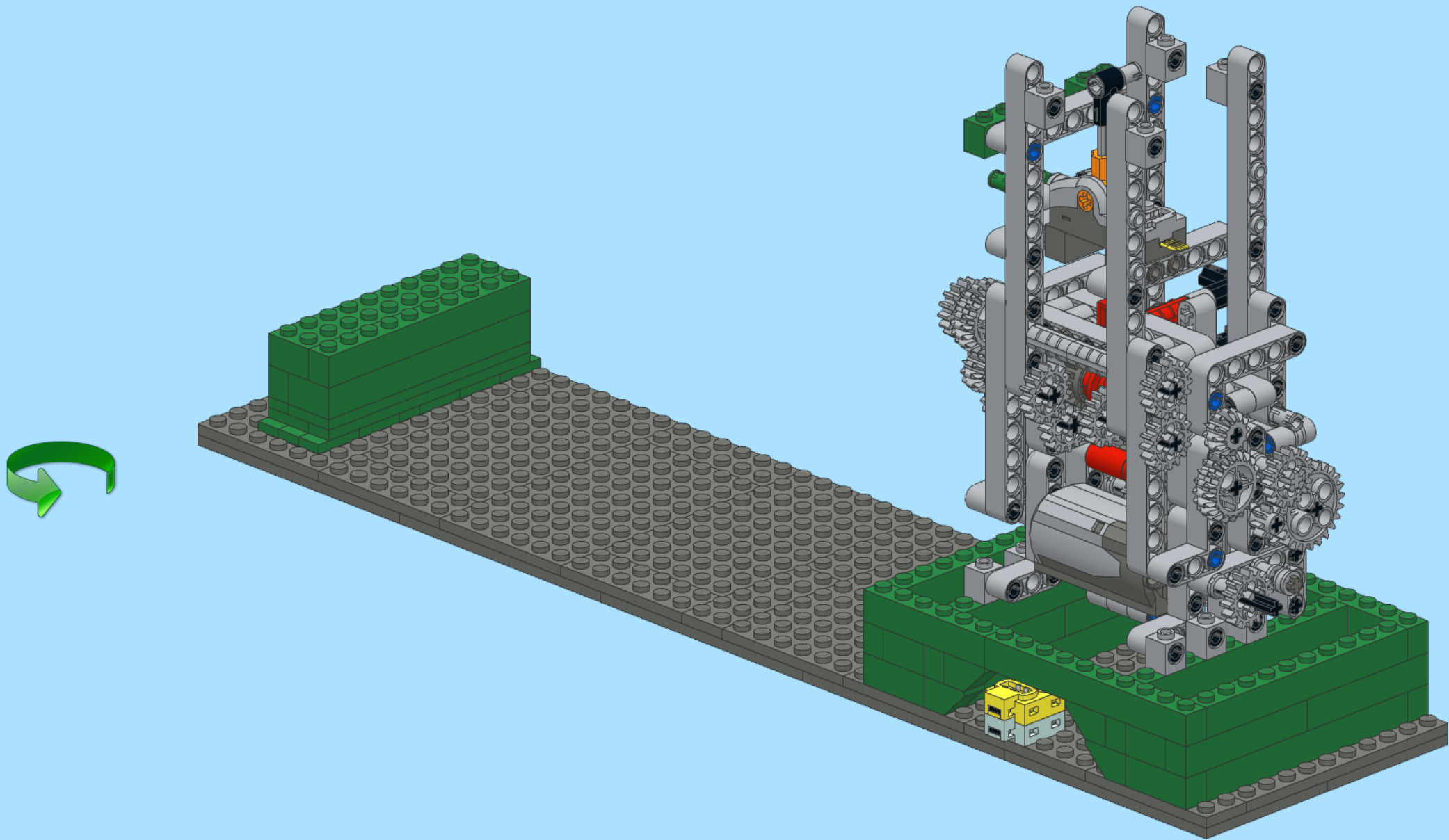

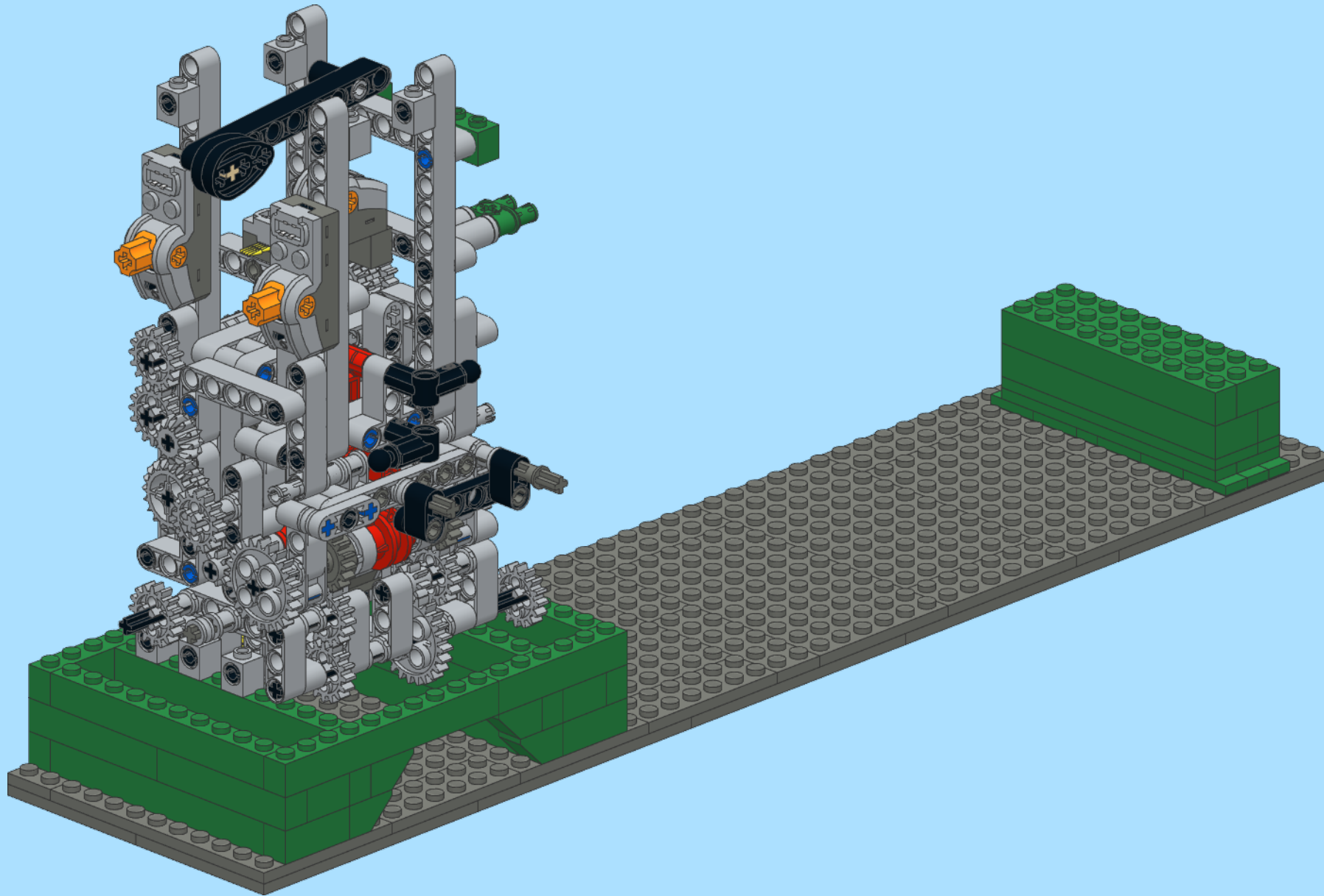
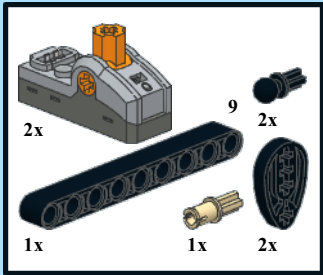

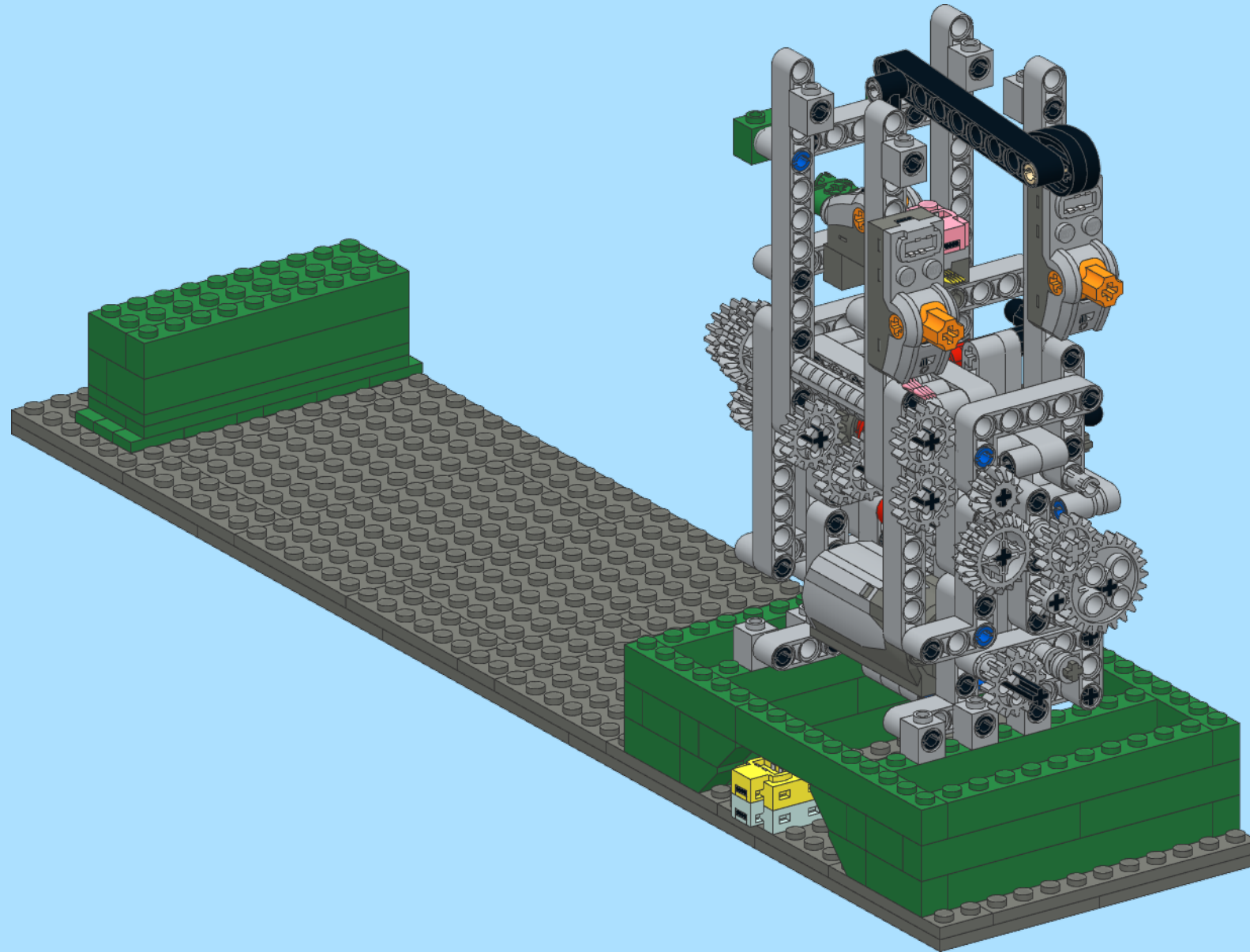



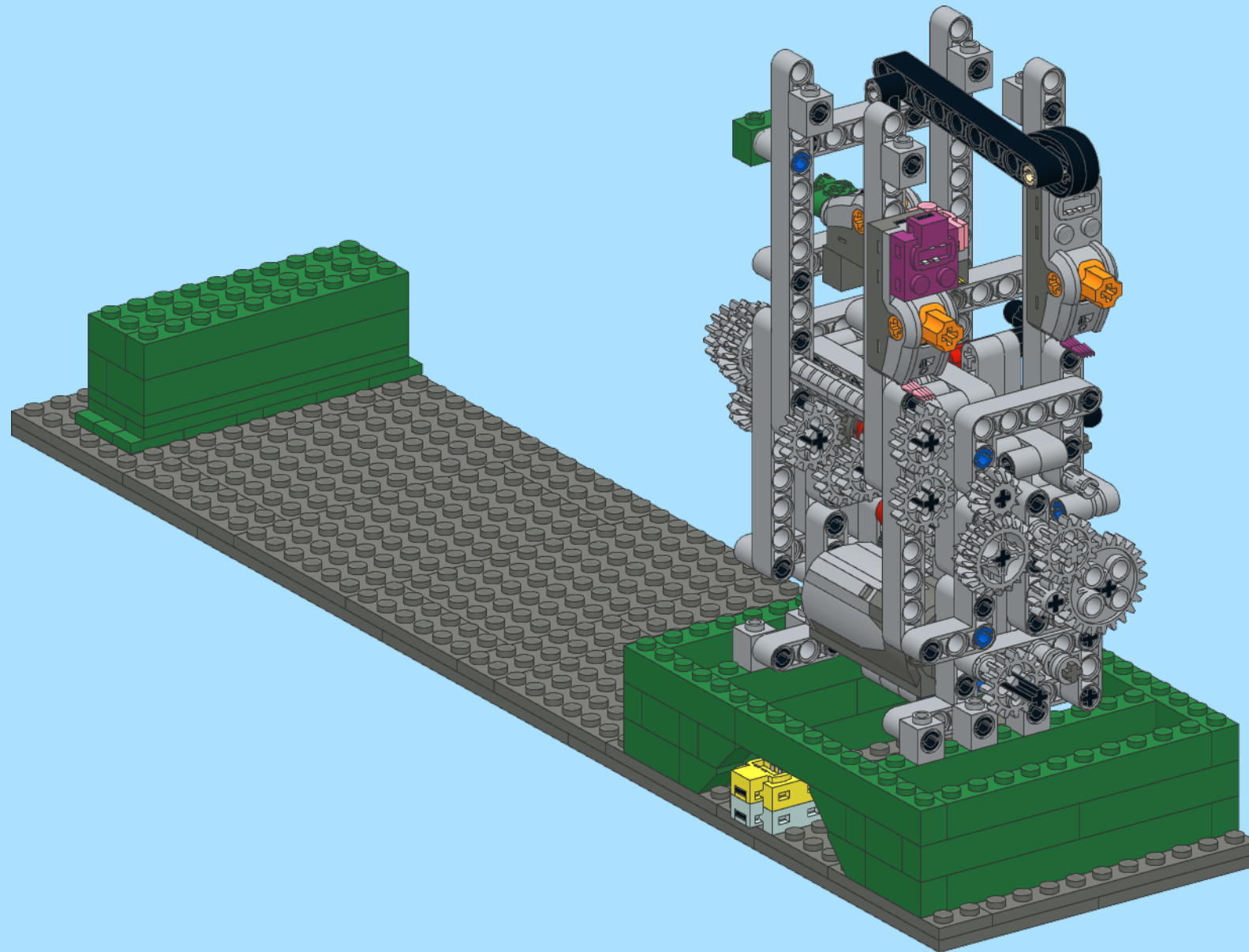

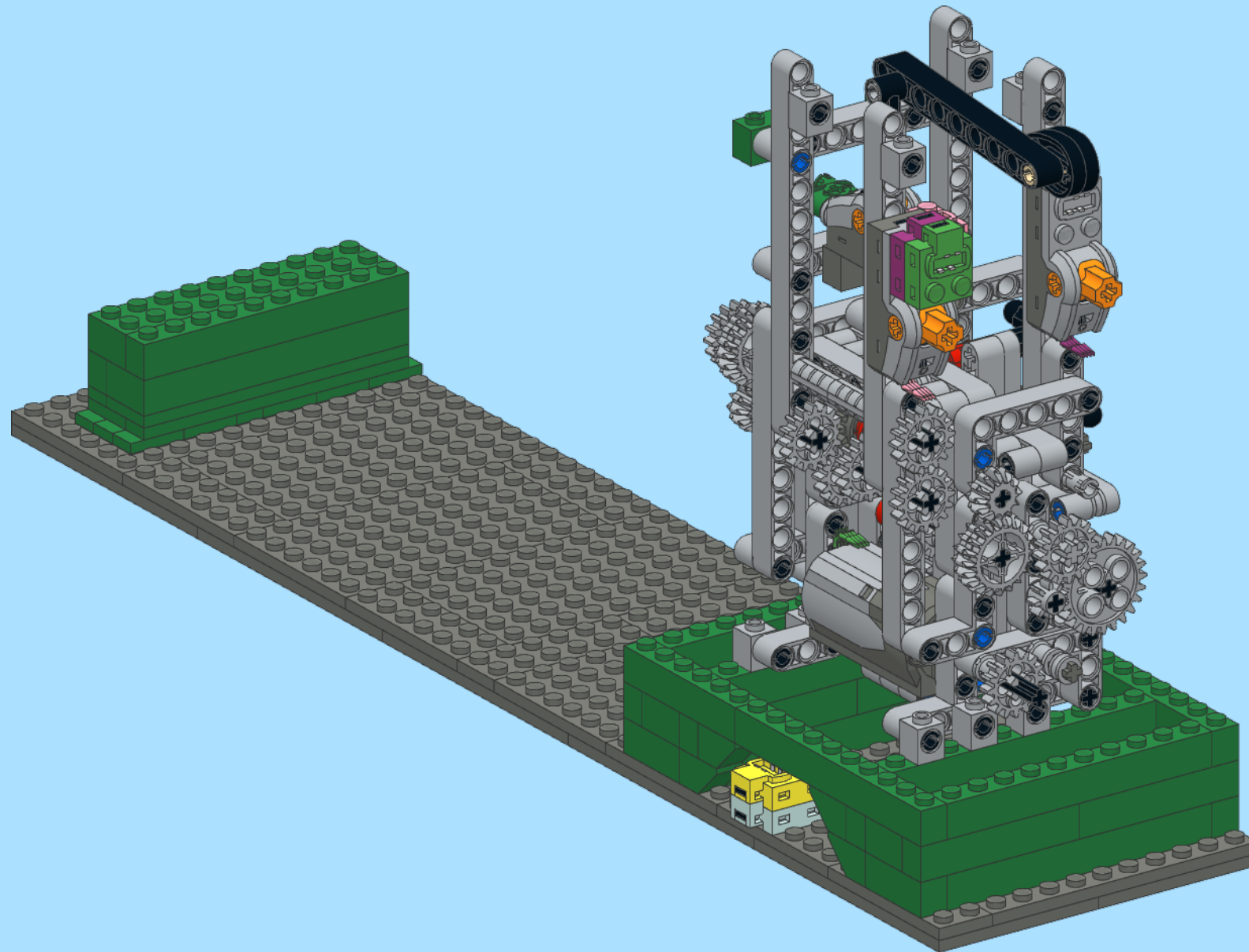

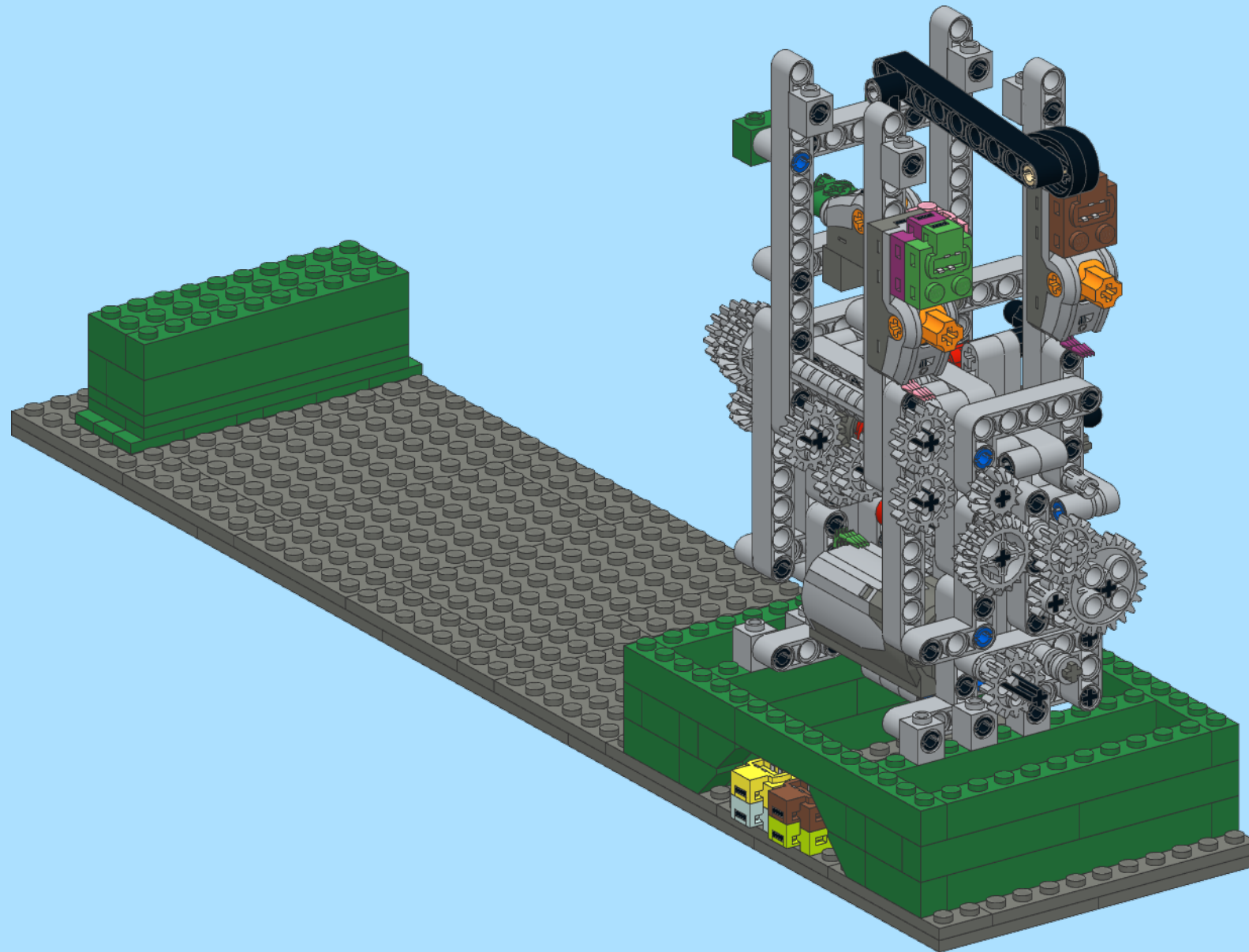

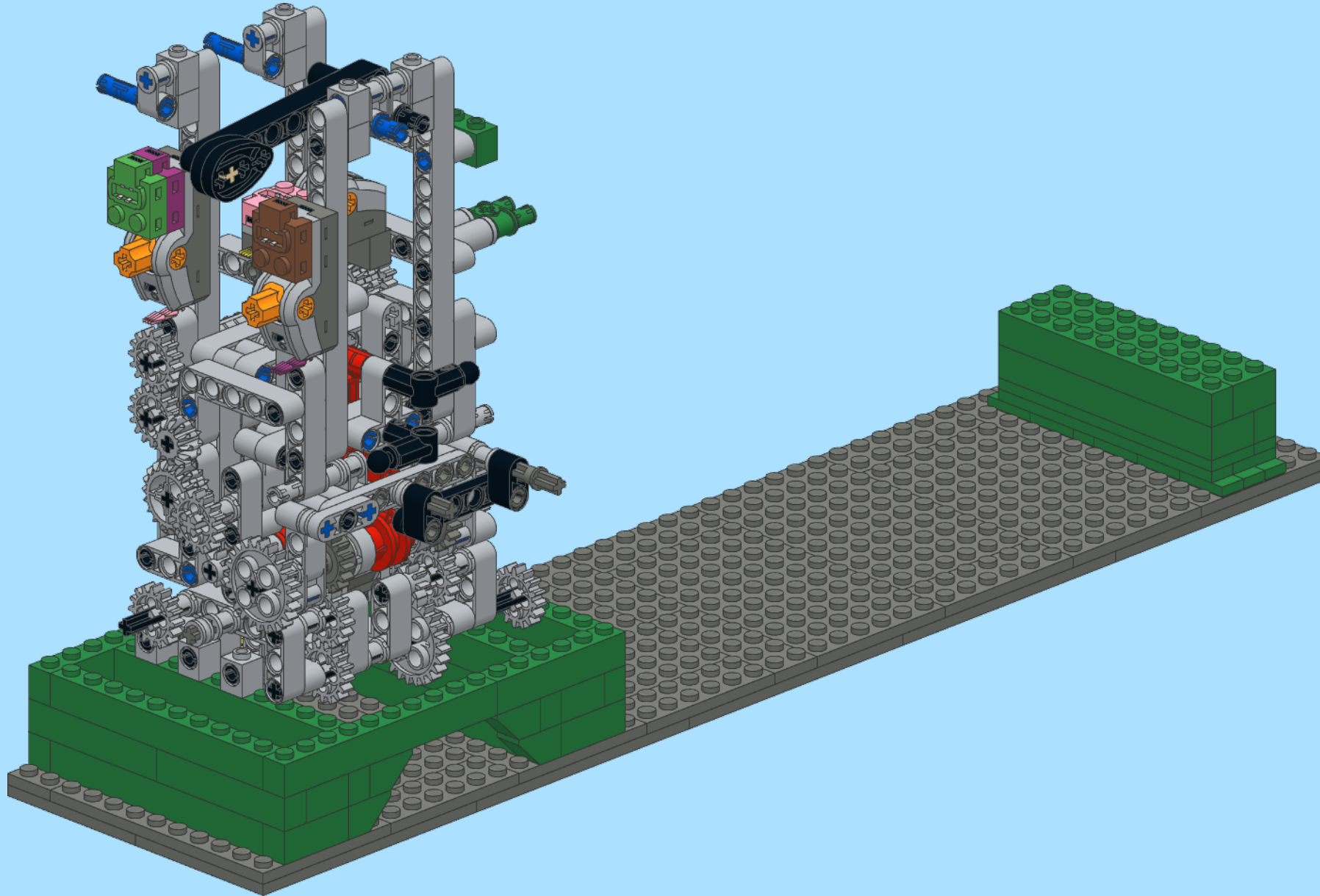
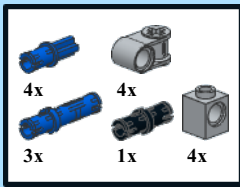

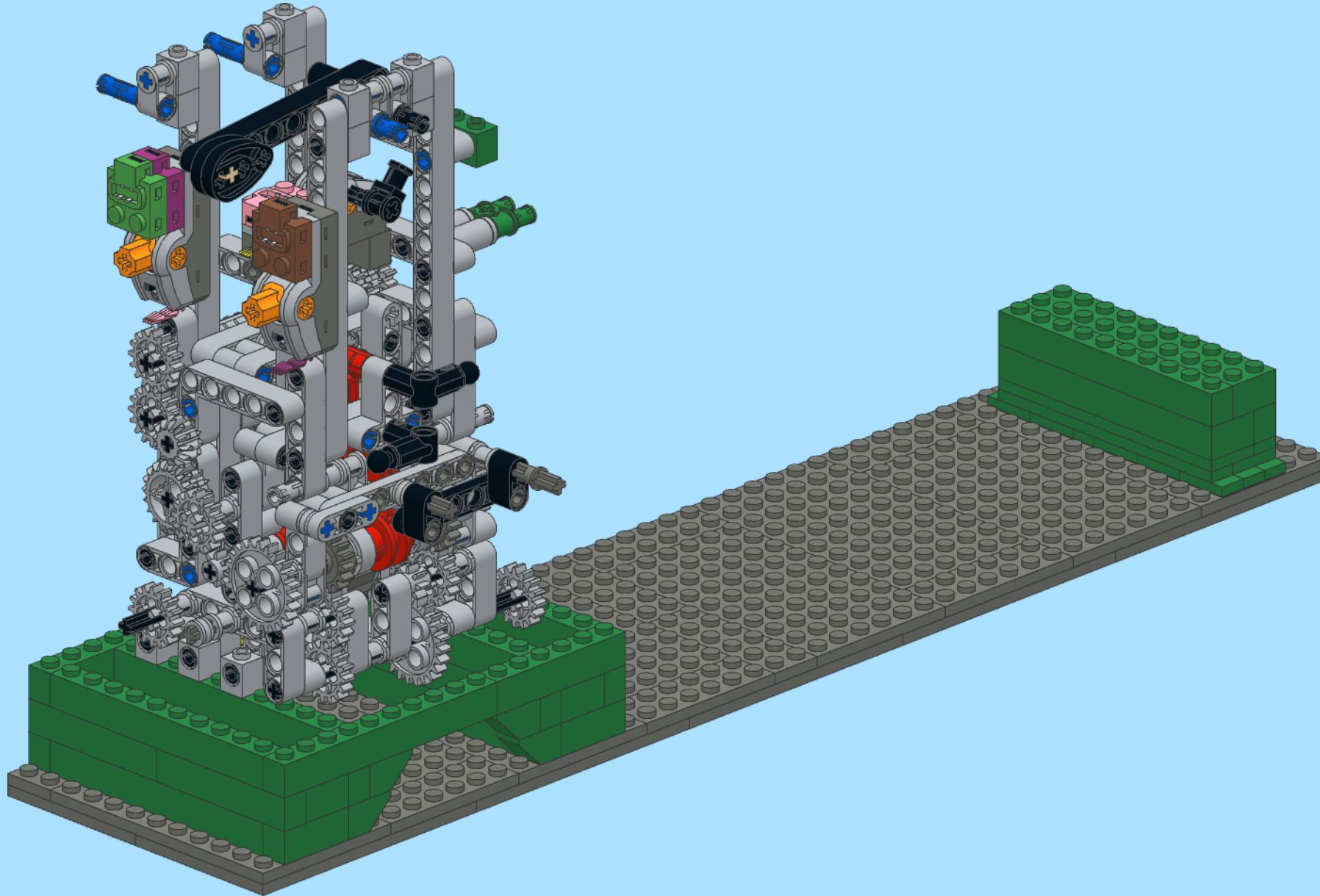
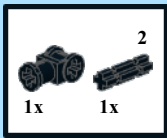

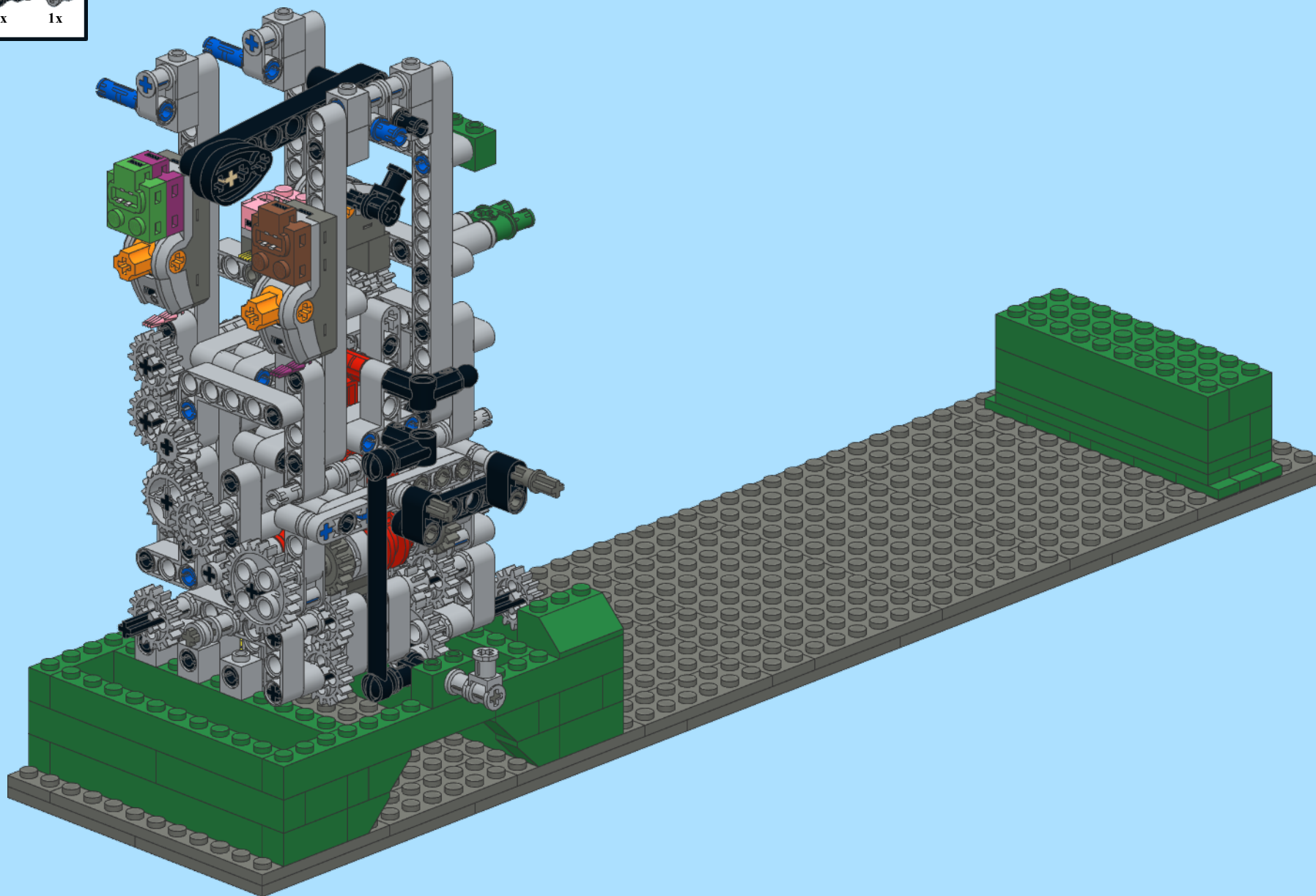
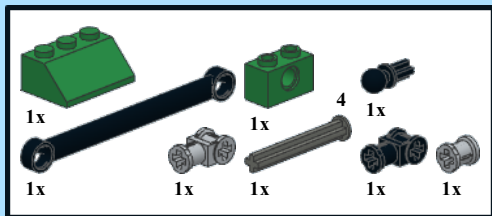

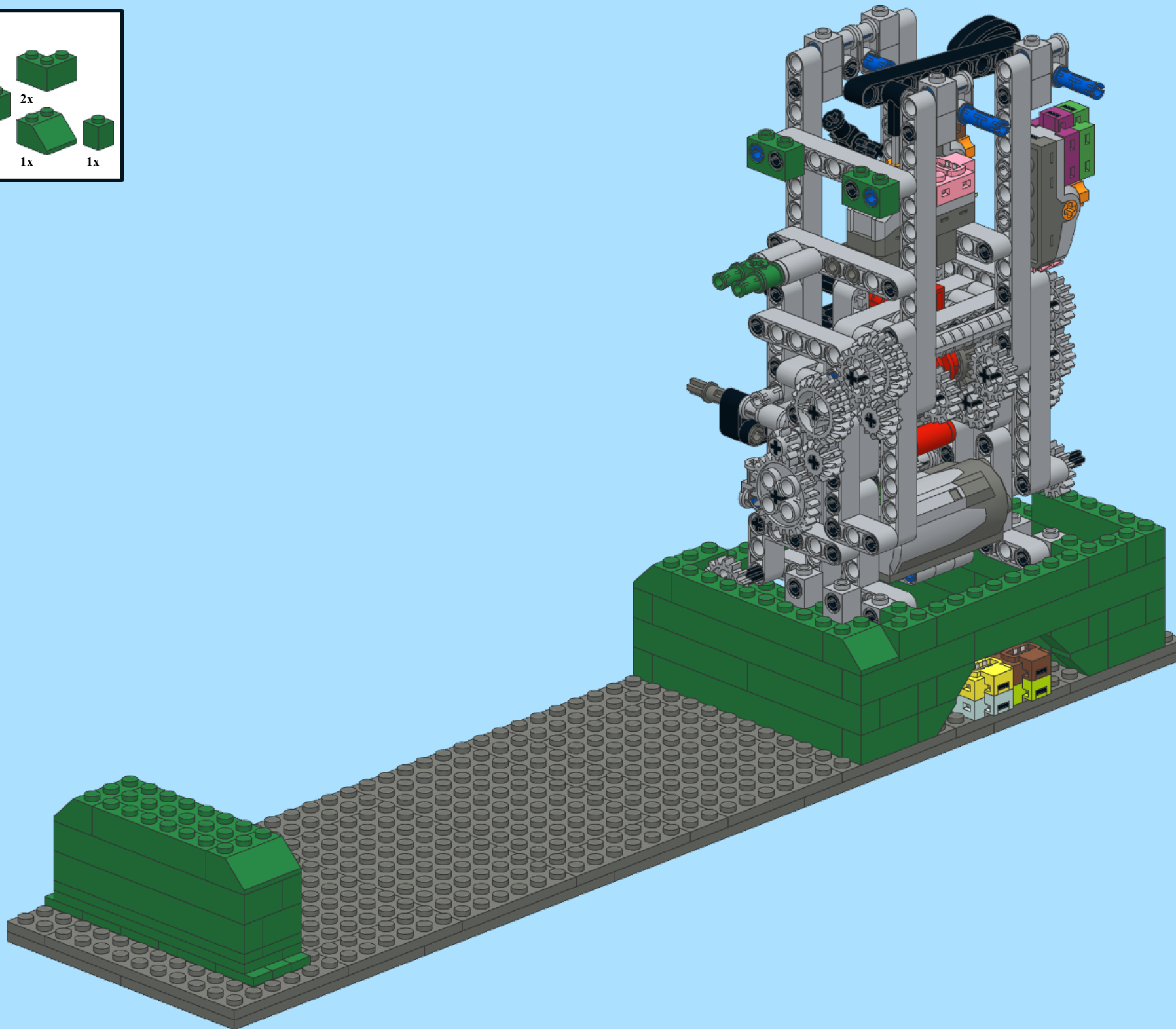
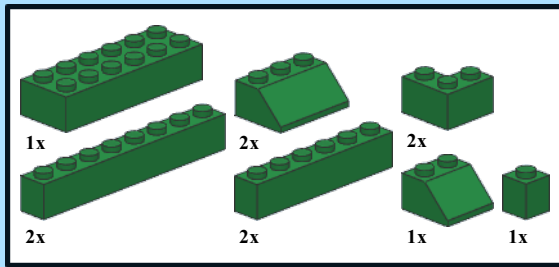

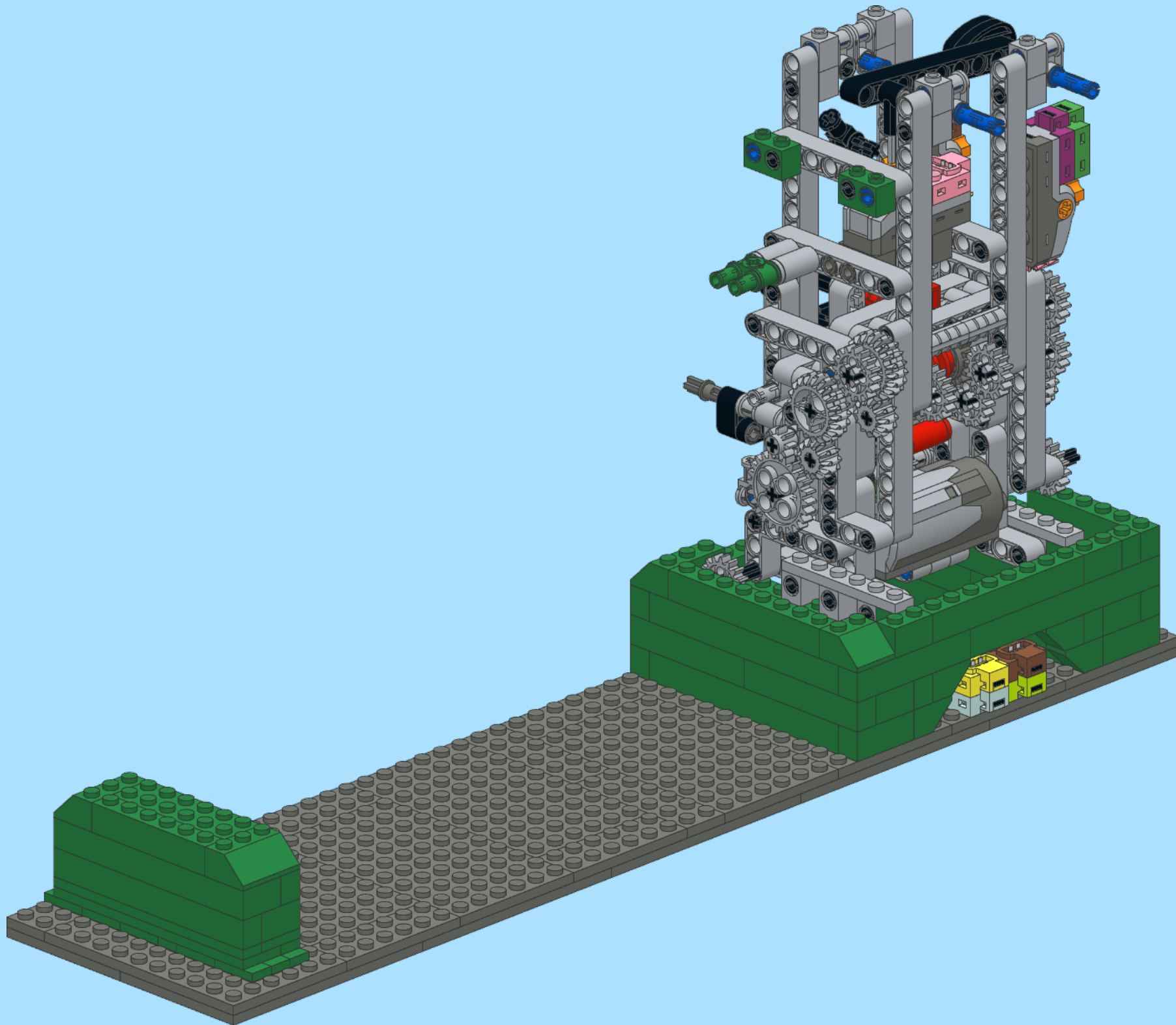
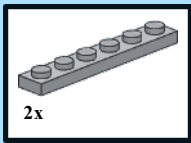



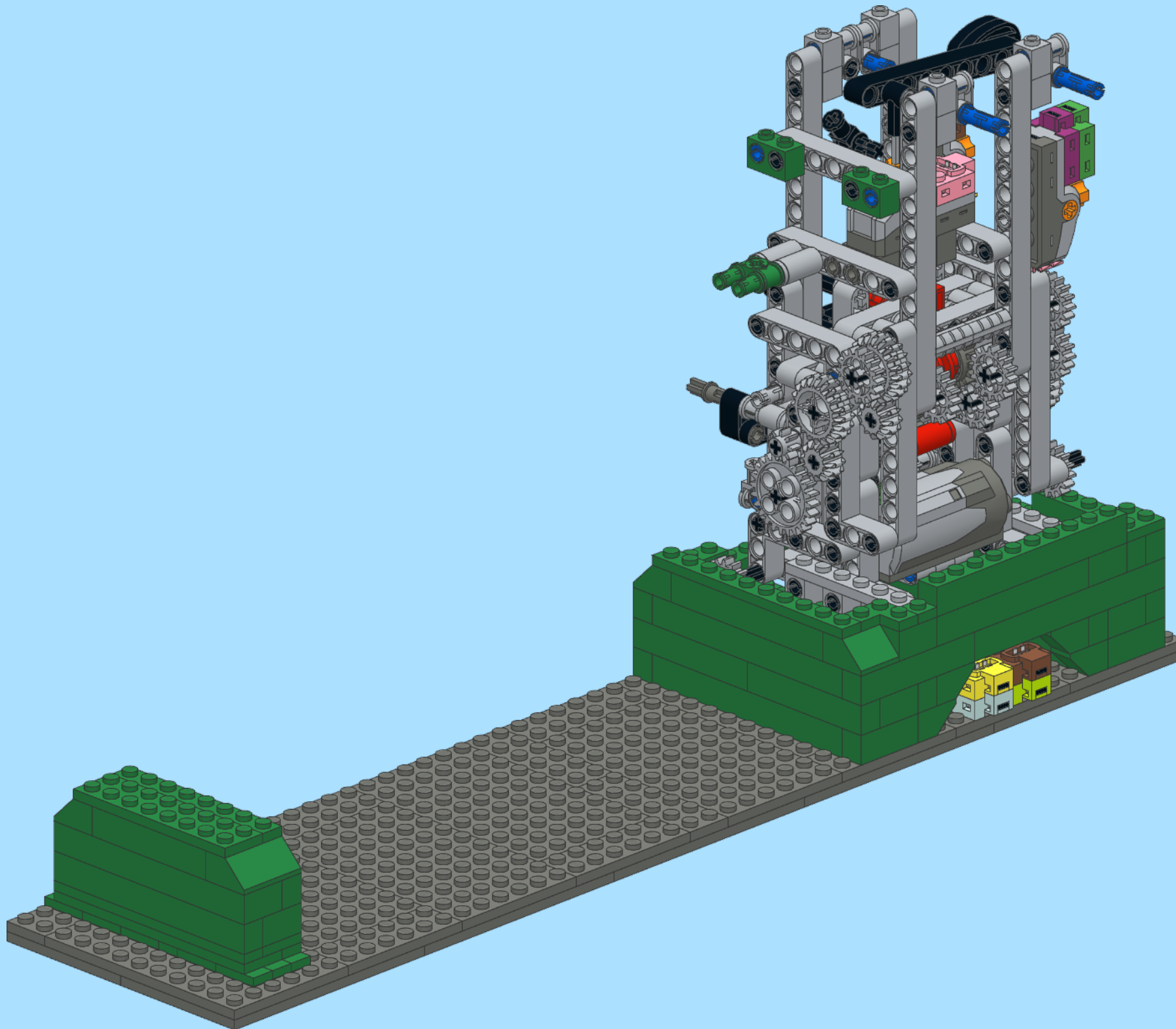
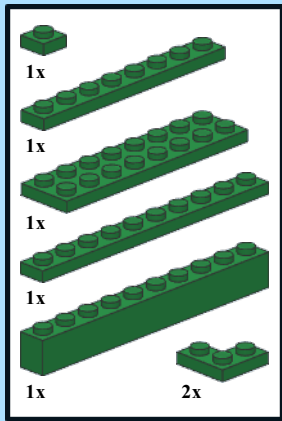

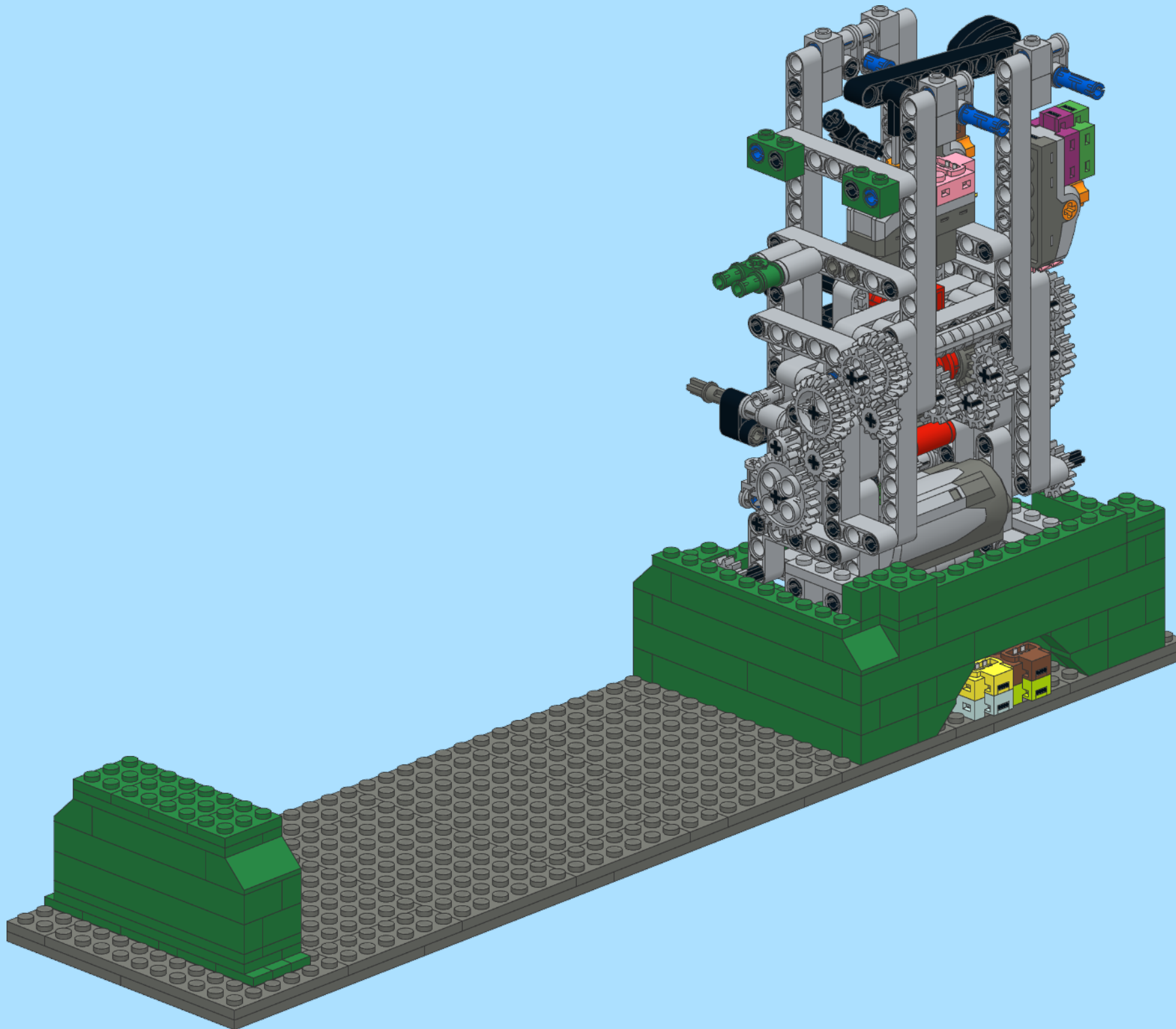
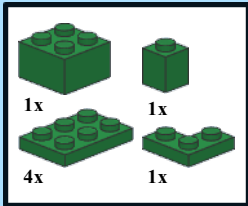

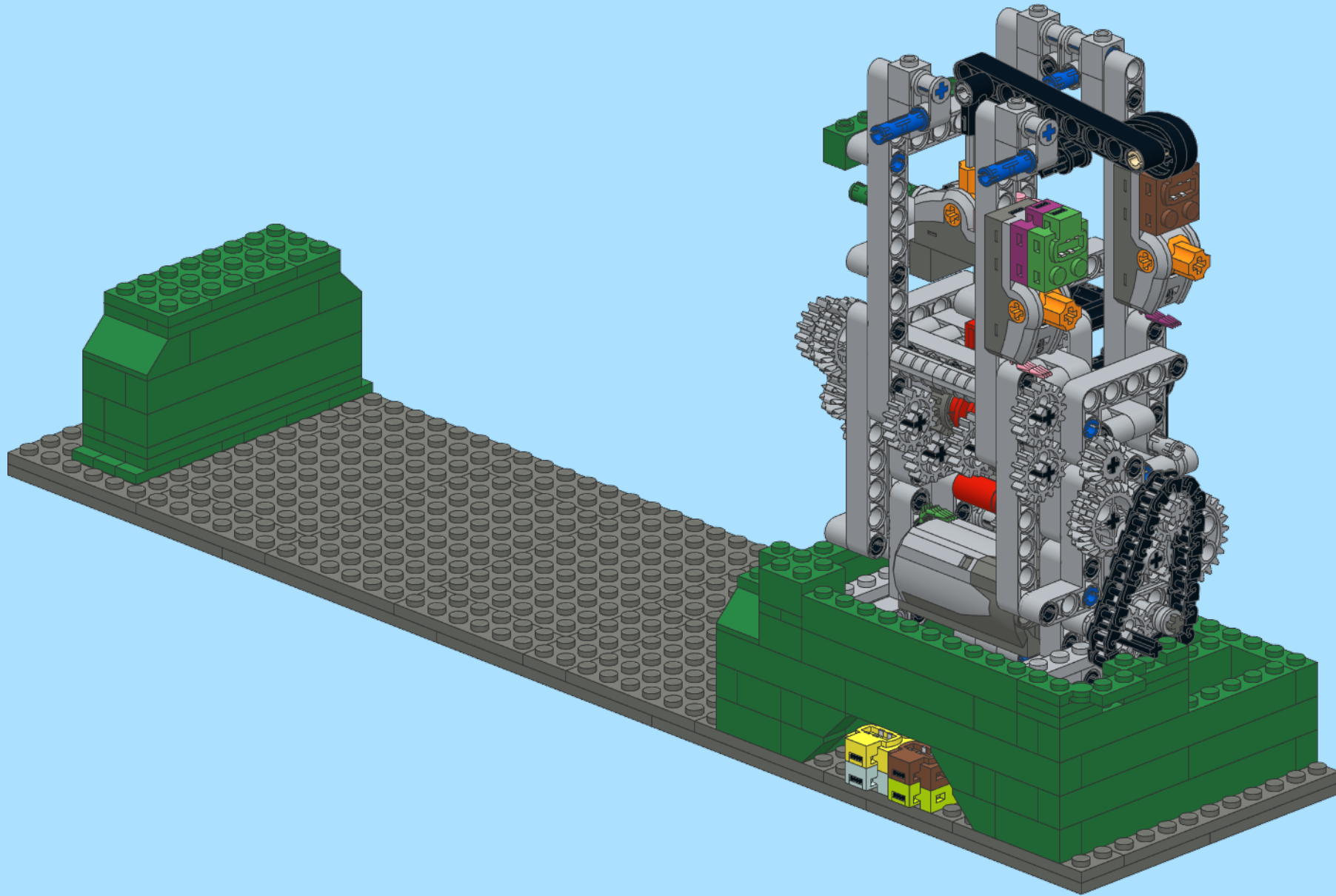
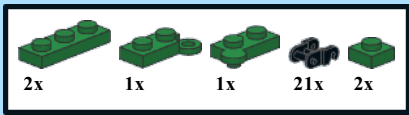

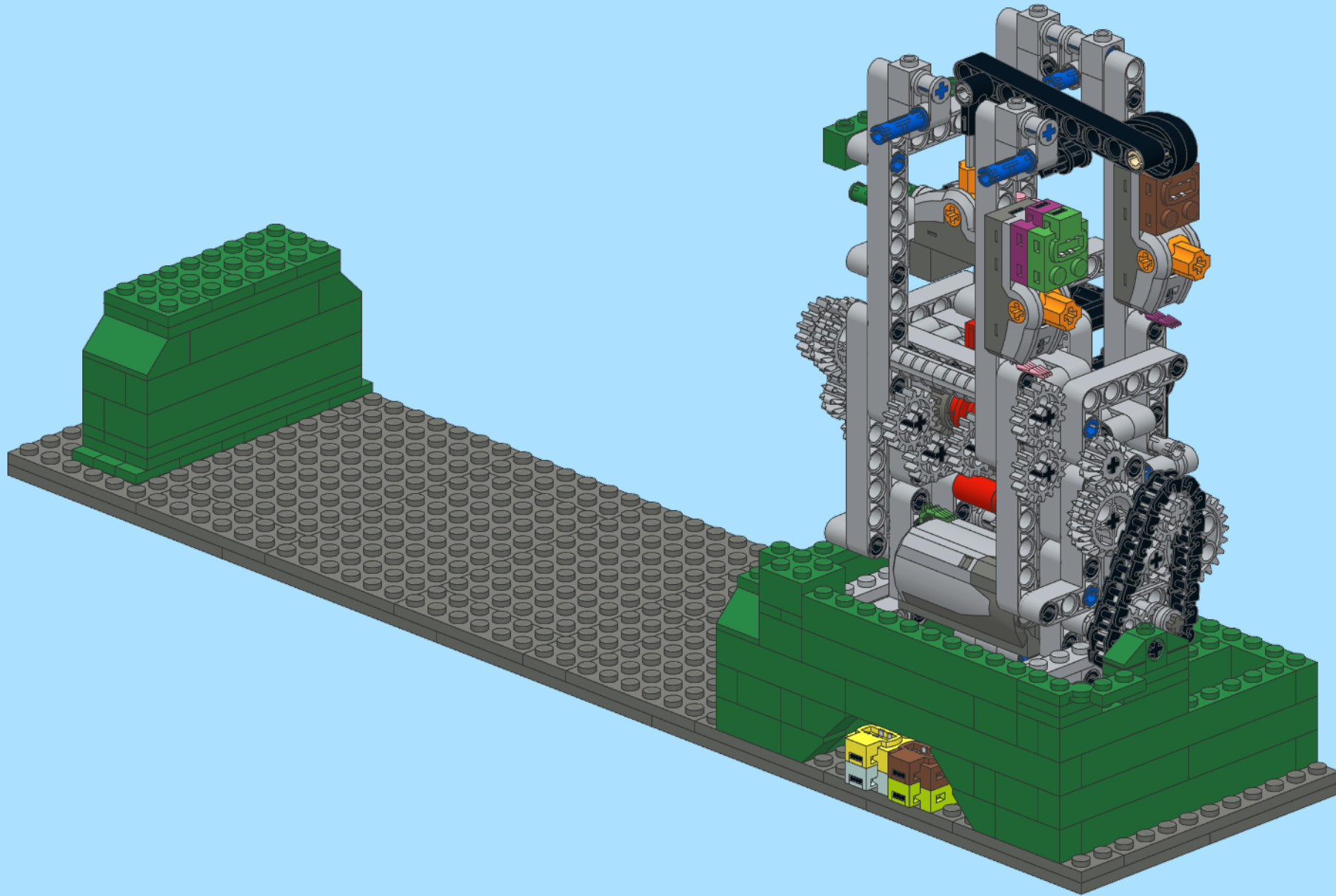
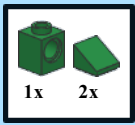

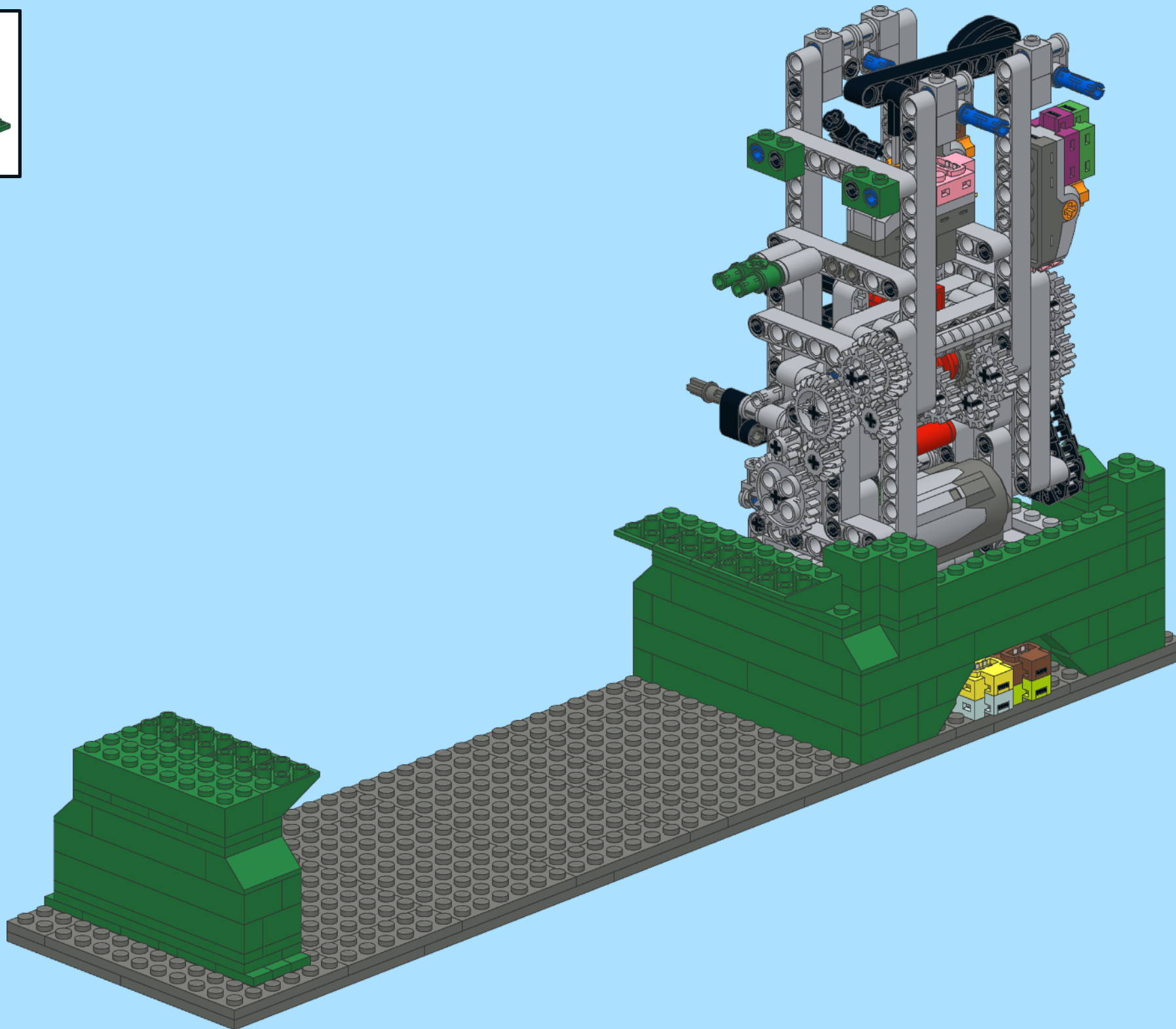
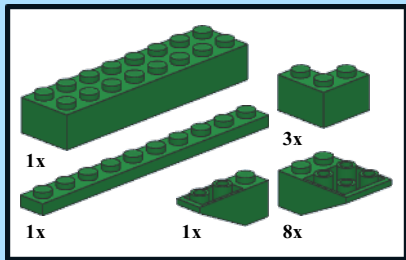

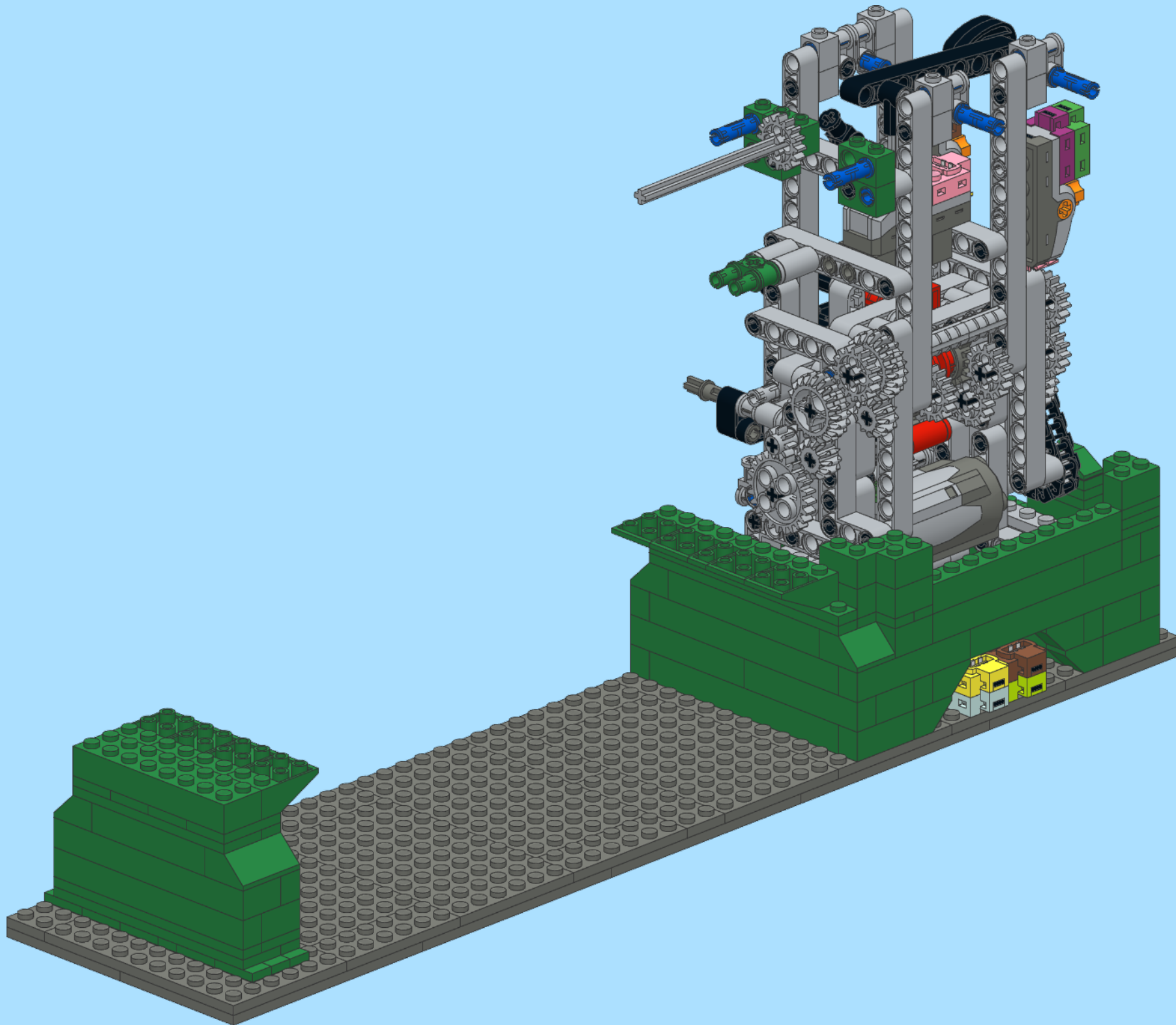
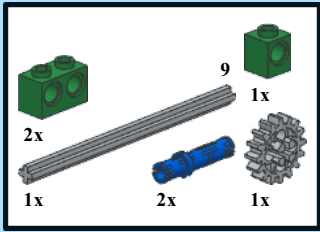

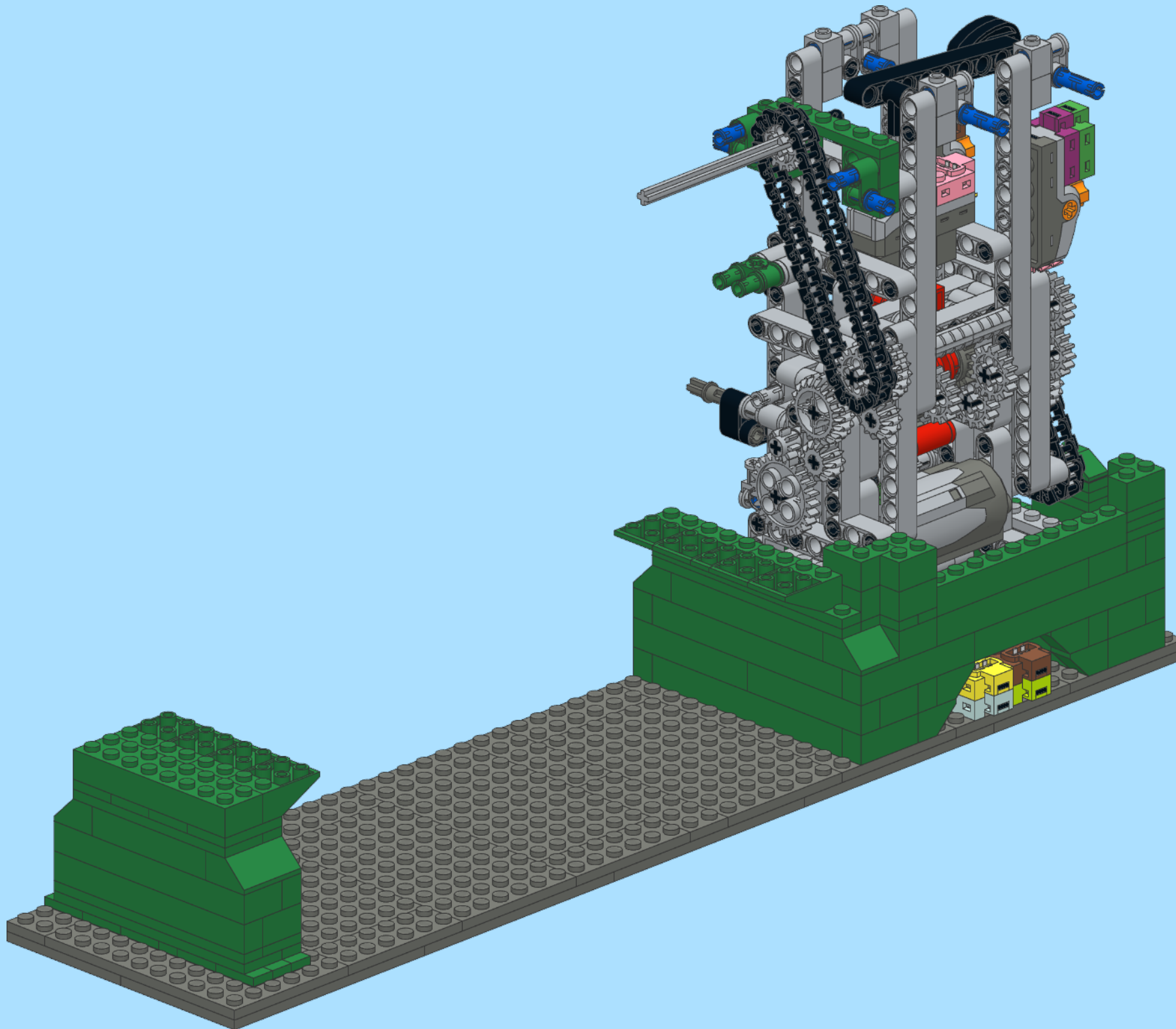
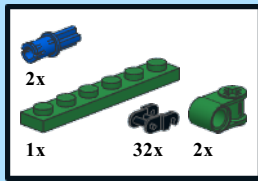



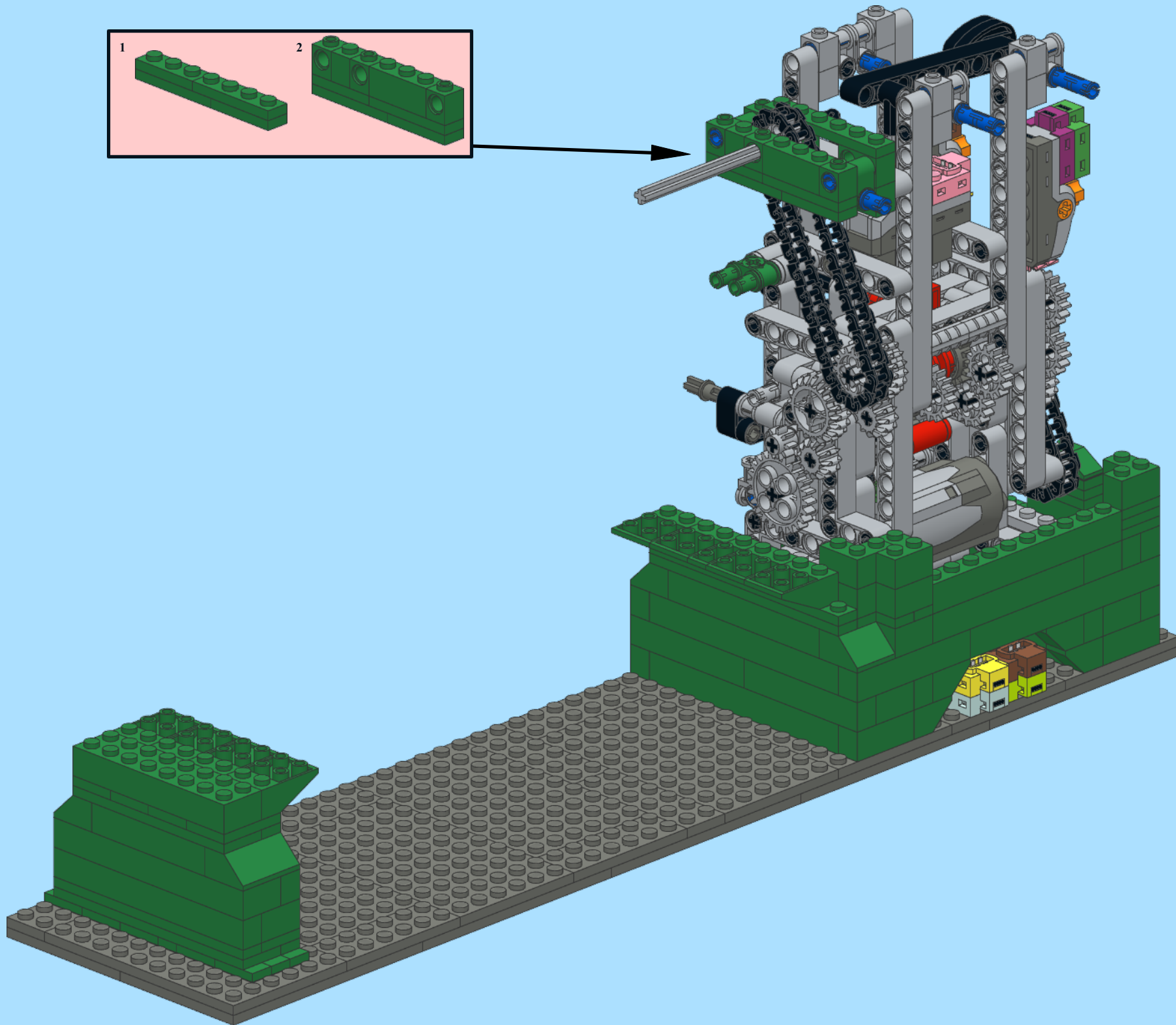
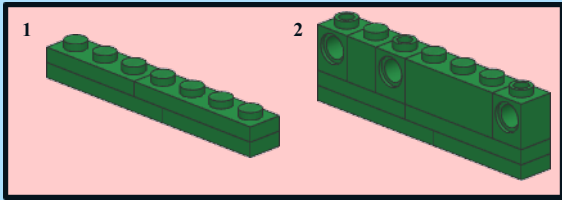



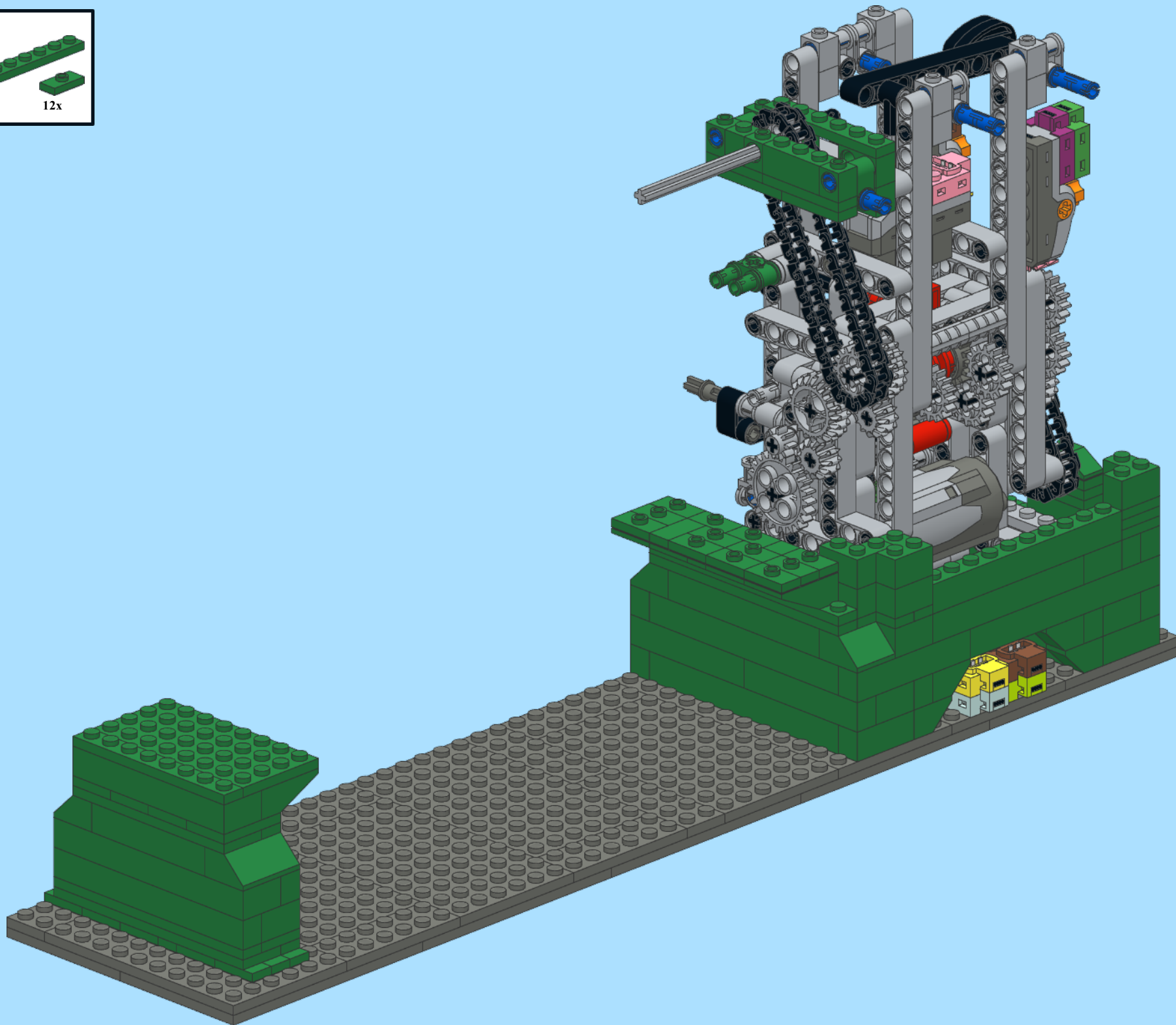
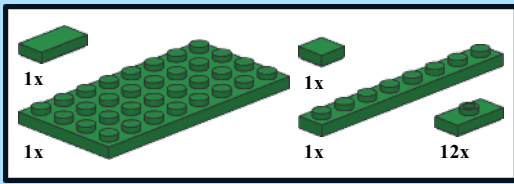

- 2x
- 1x
- 2x
- 1x
- 1x
- 3x







-  4x
-  1x
-  4x
-  1x
-  1x
-  4x
-  1x
-  2x

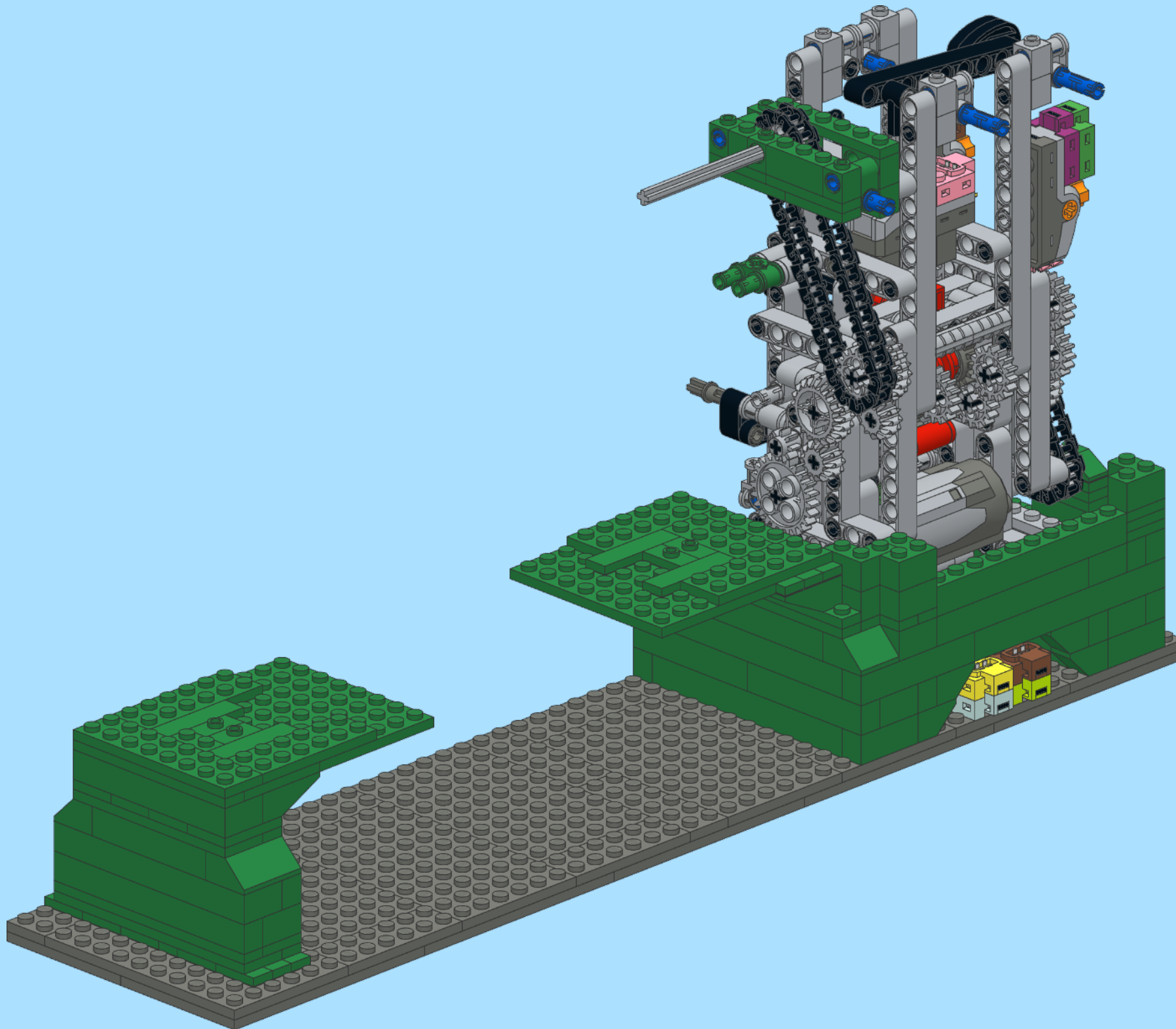

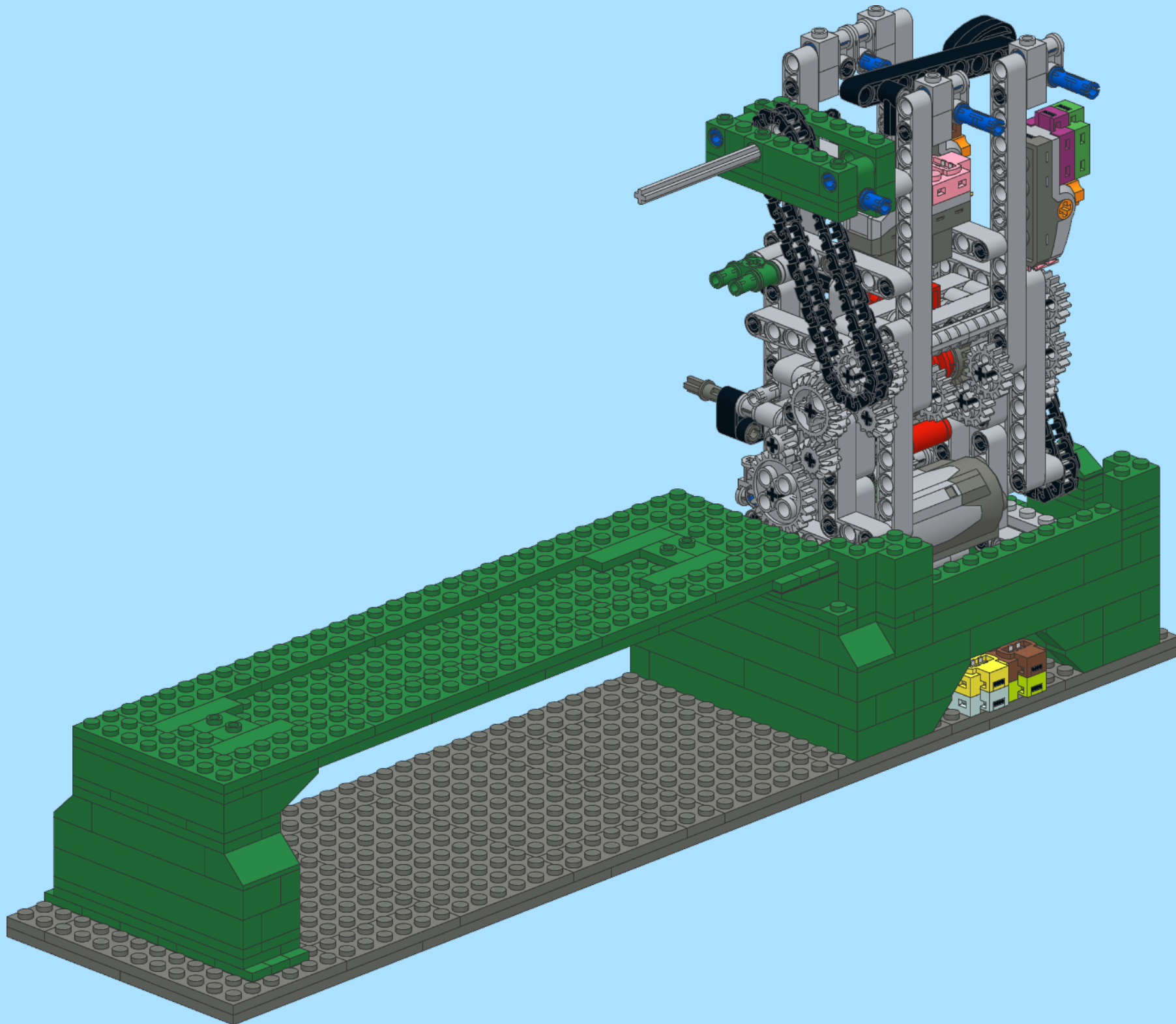
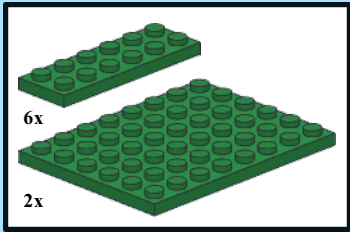

- 2x
- 1x
- 1x

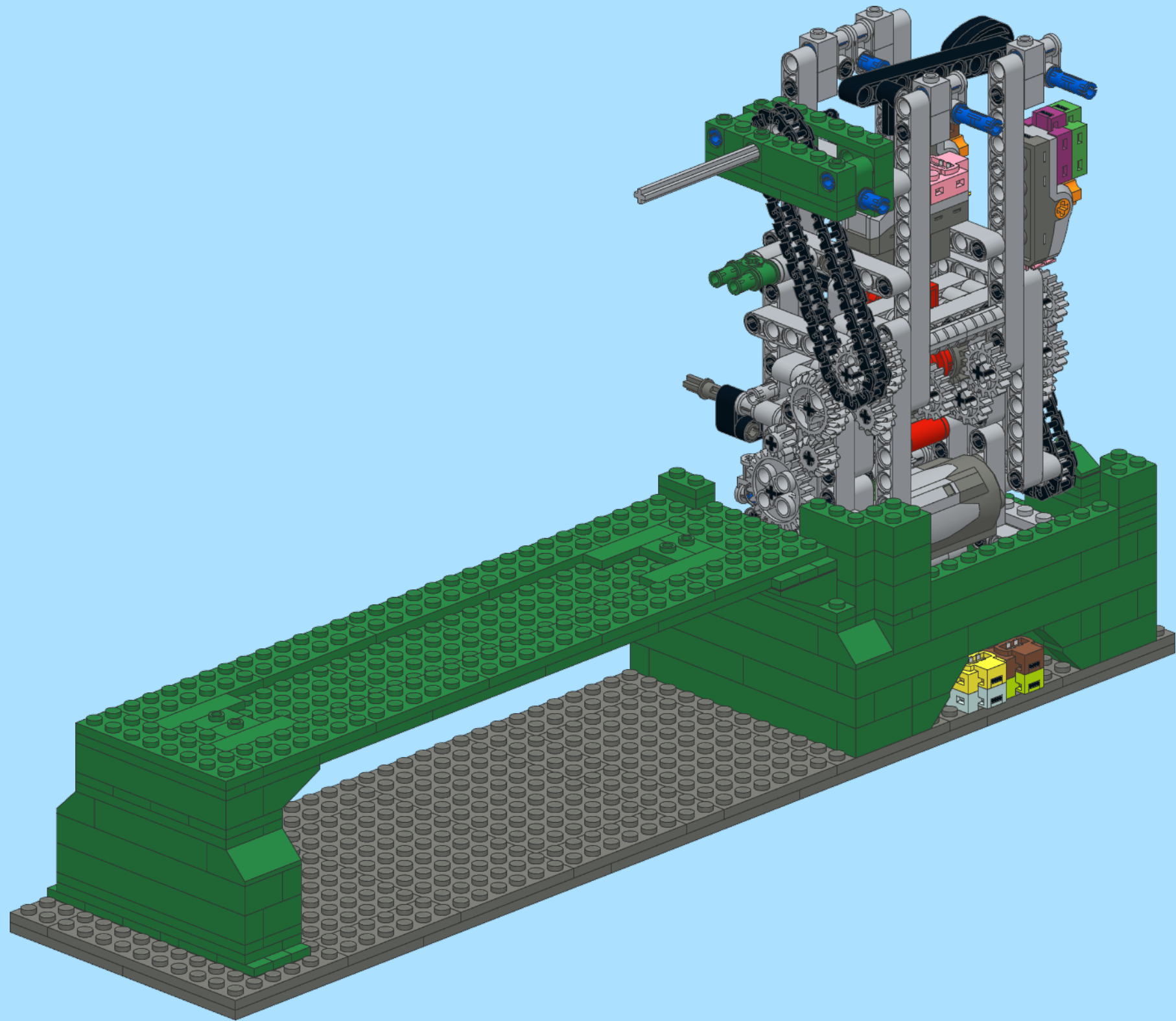

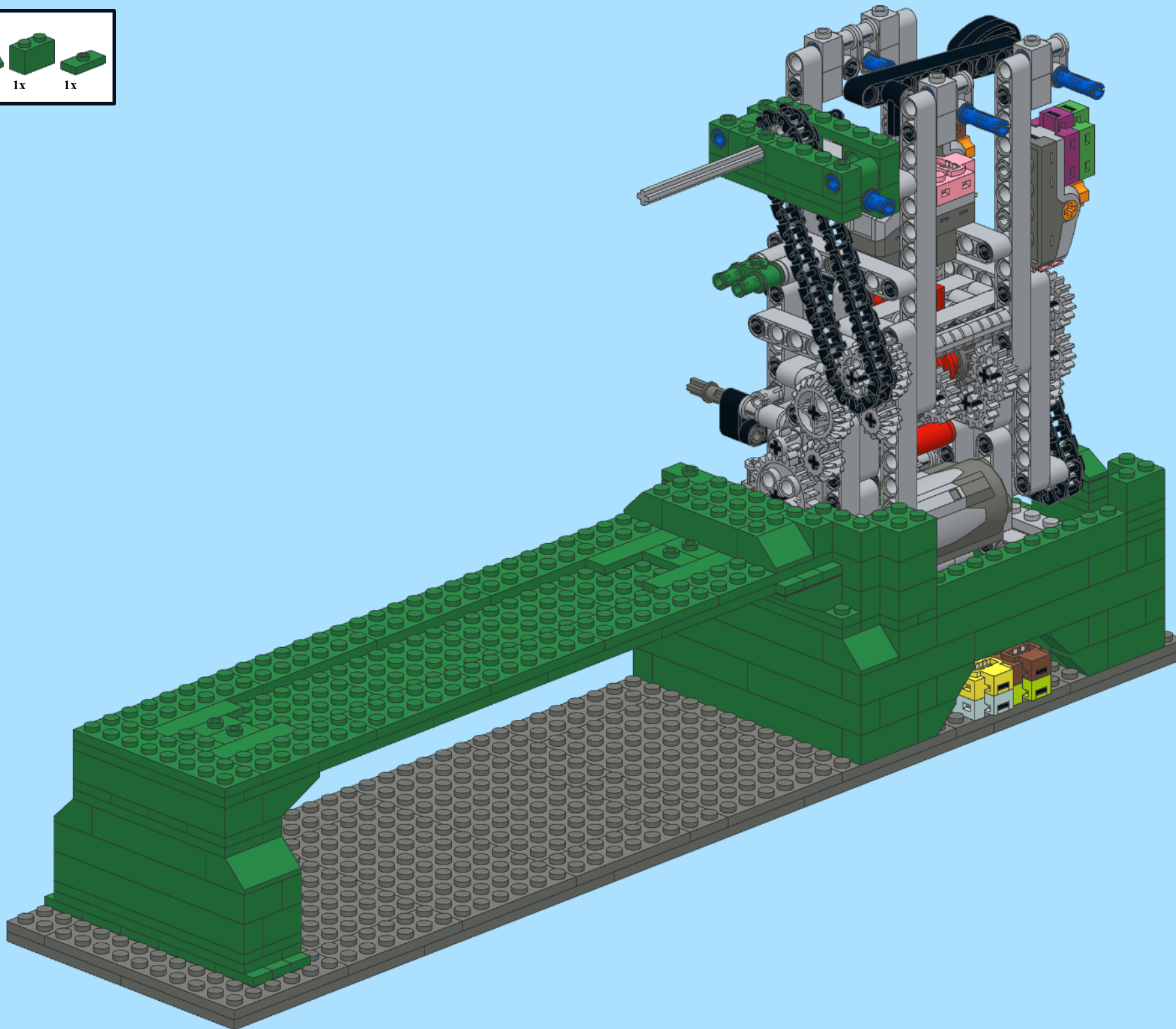
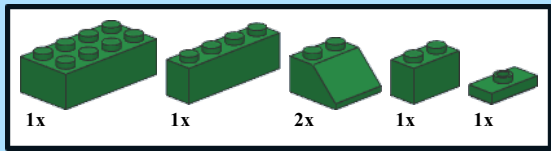

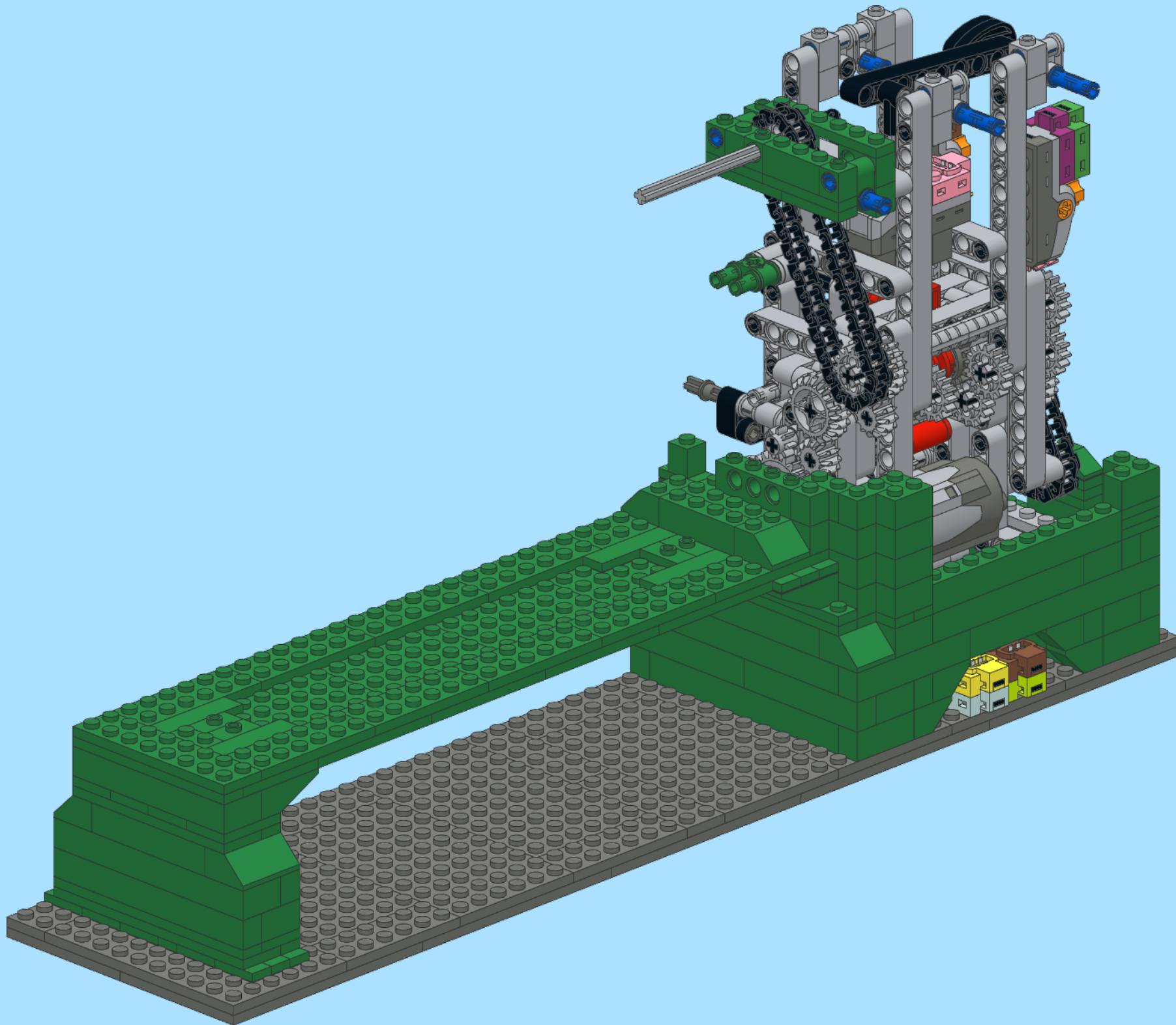
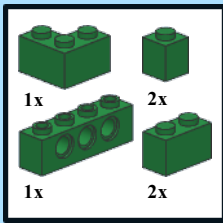

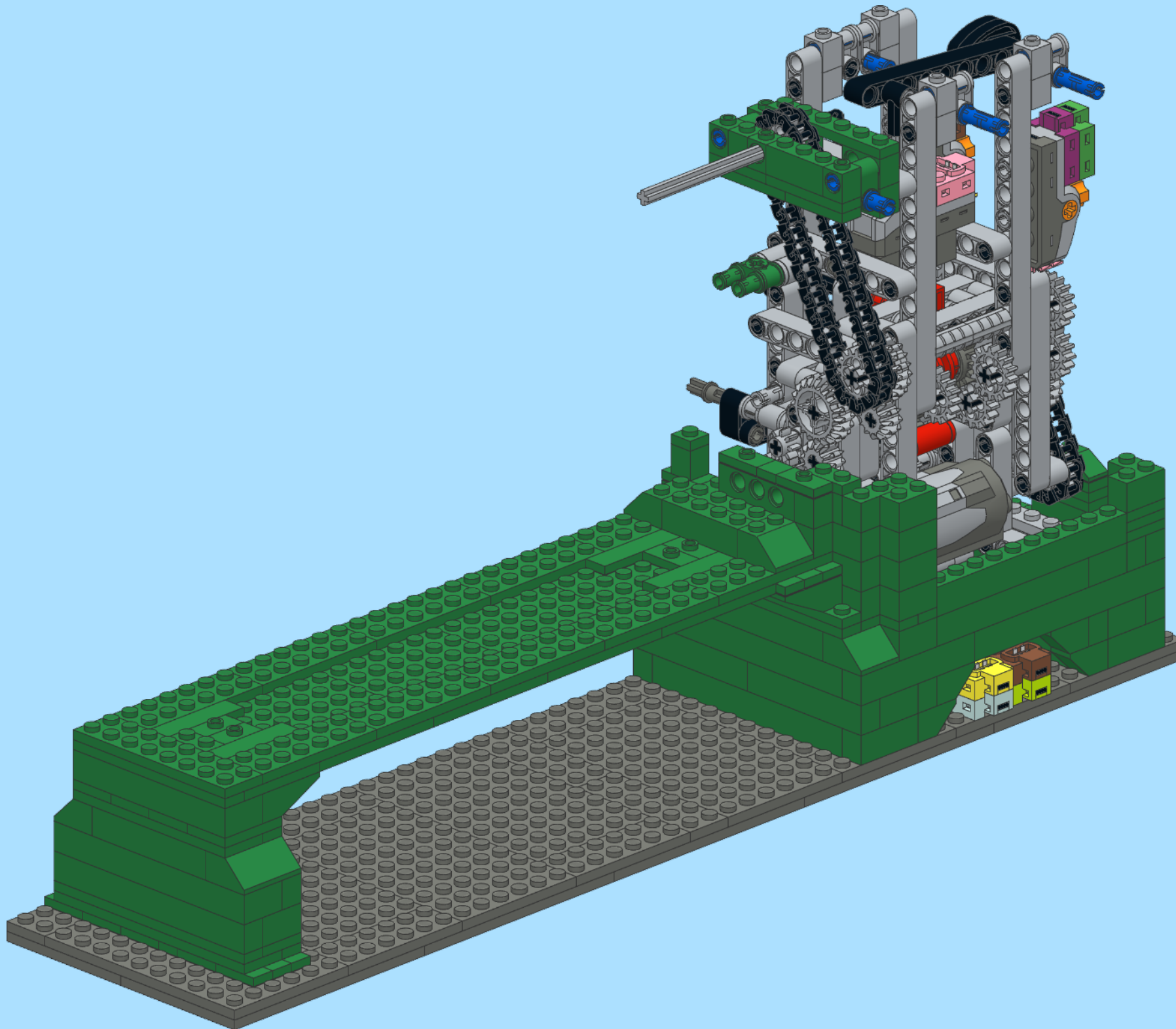
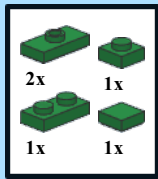

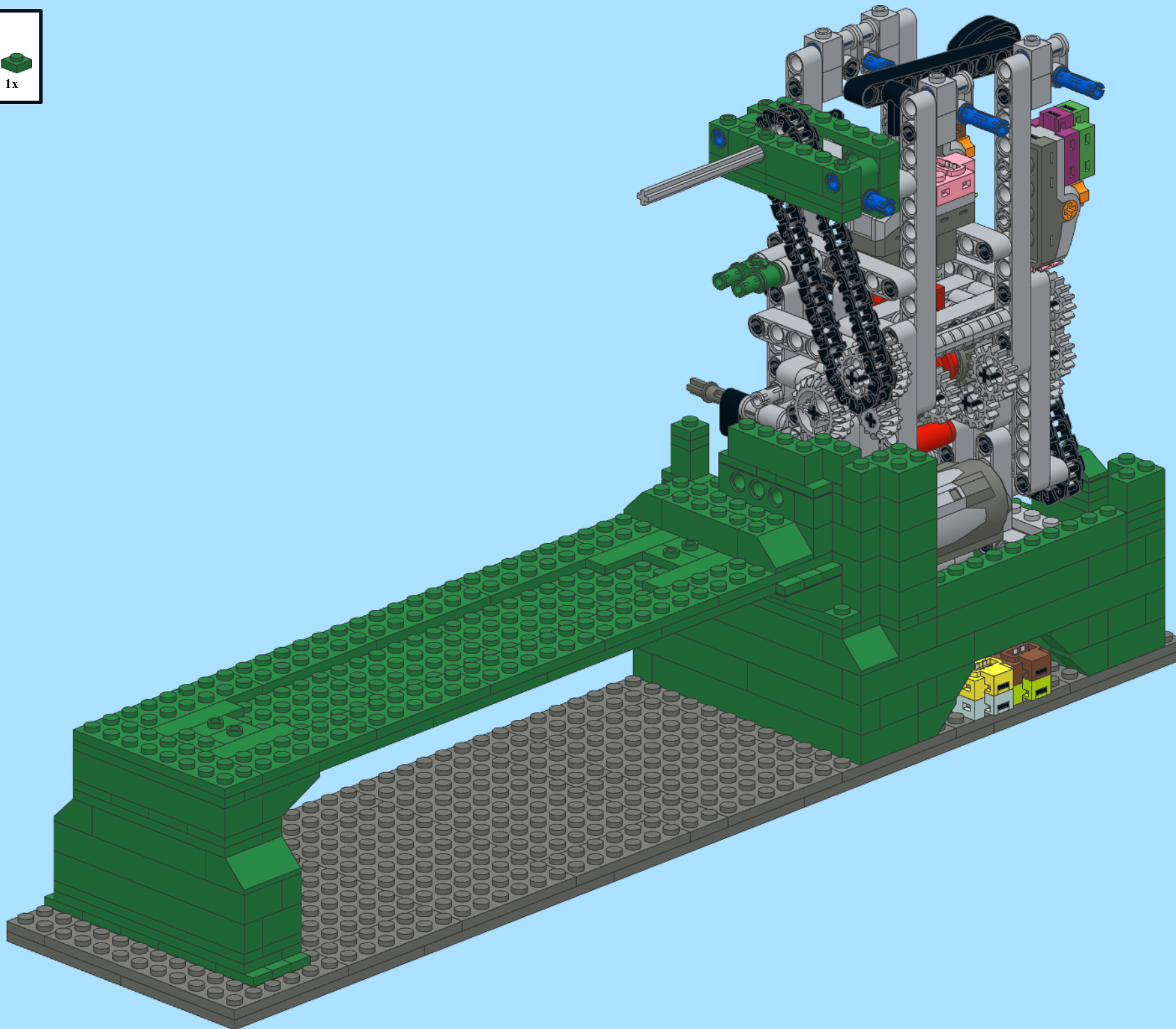
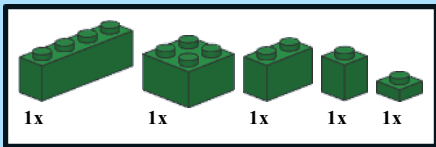



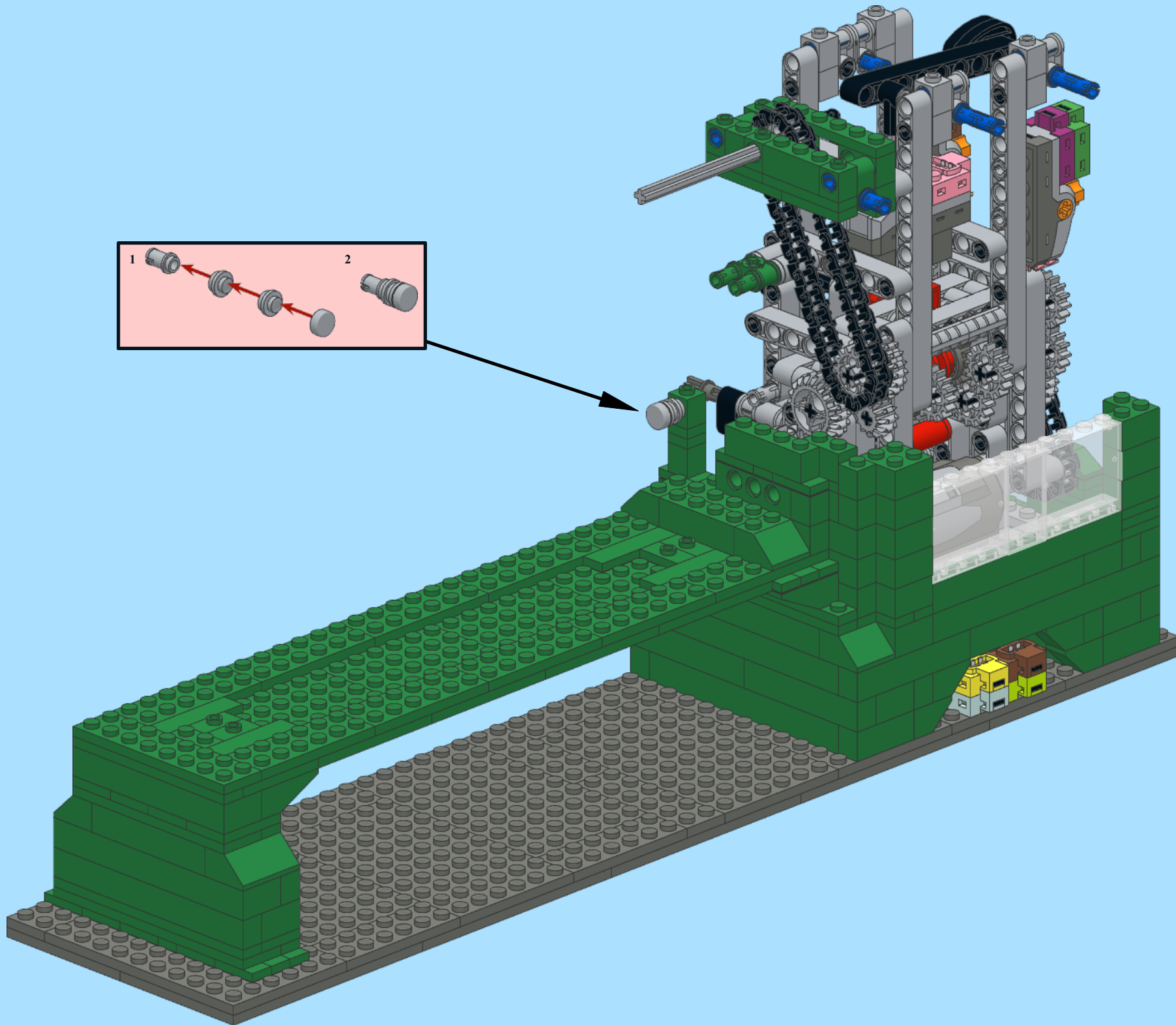
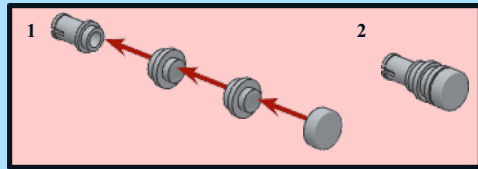
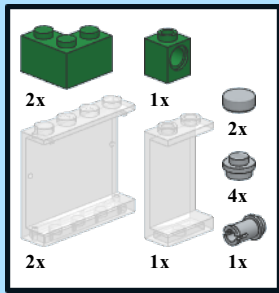

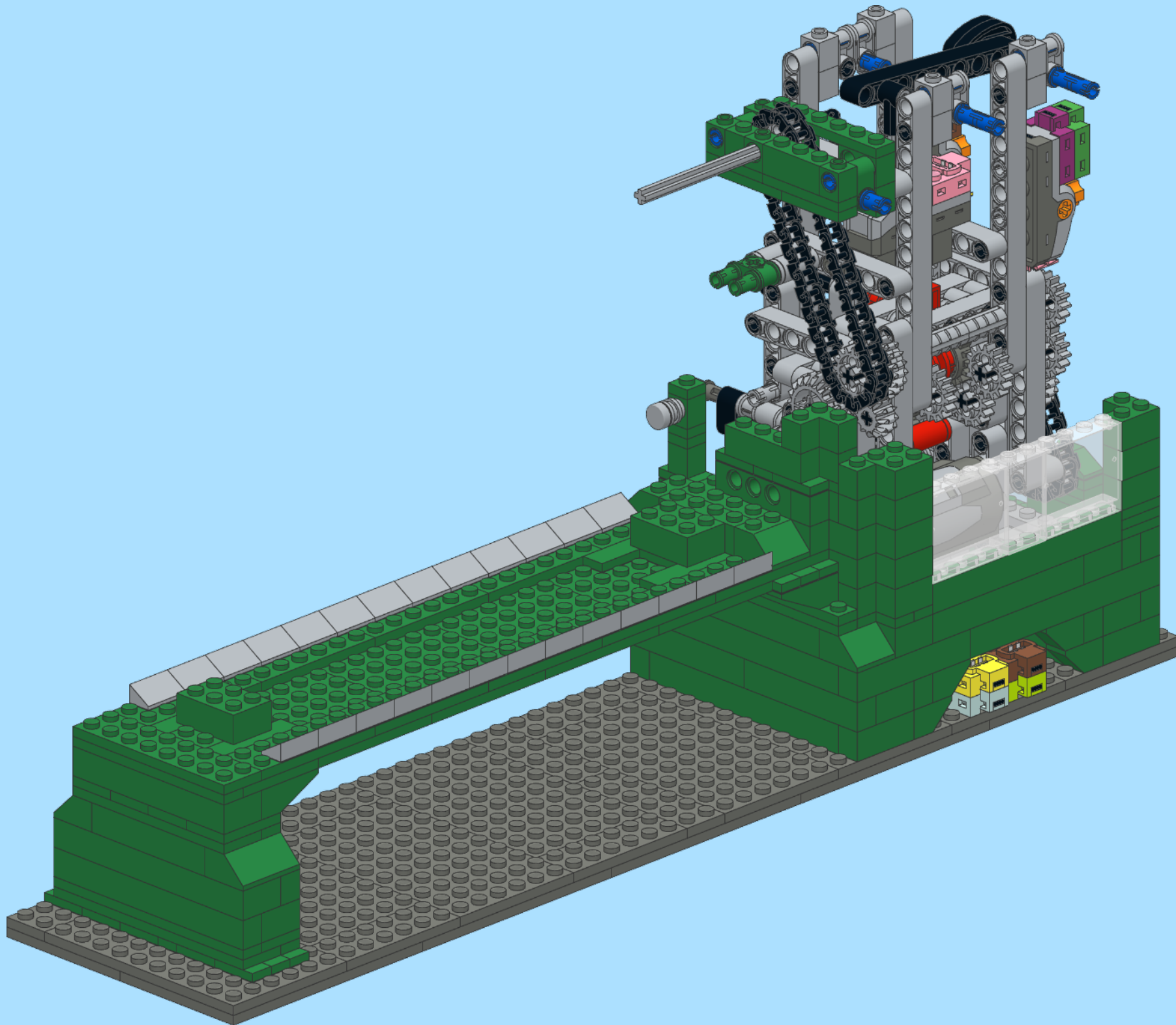
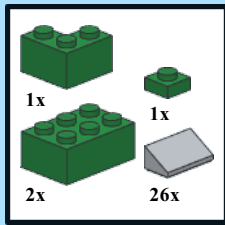

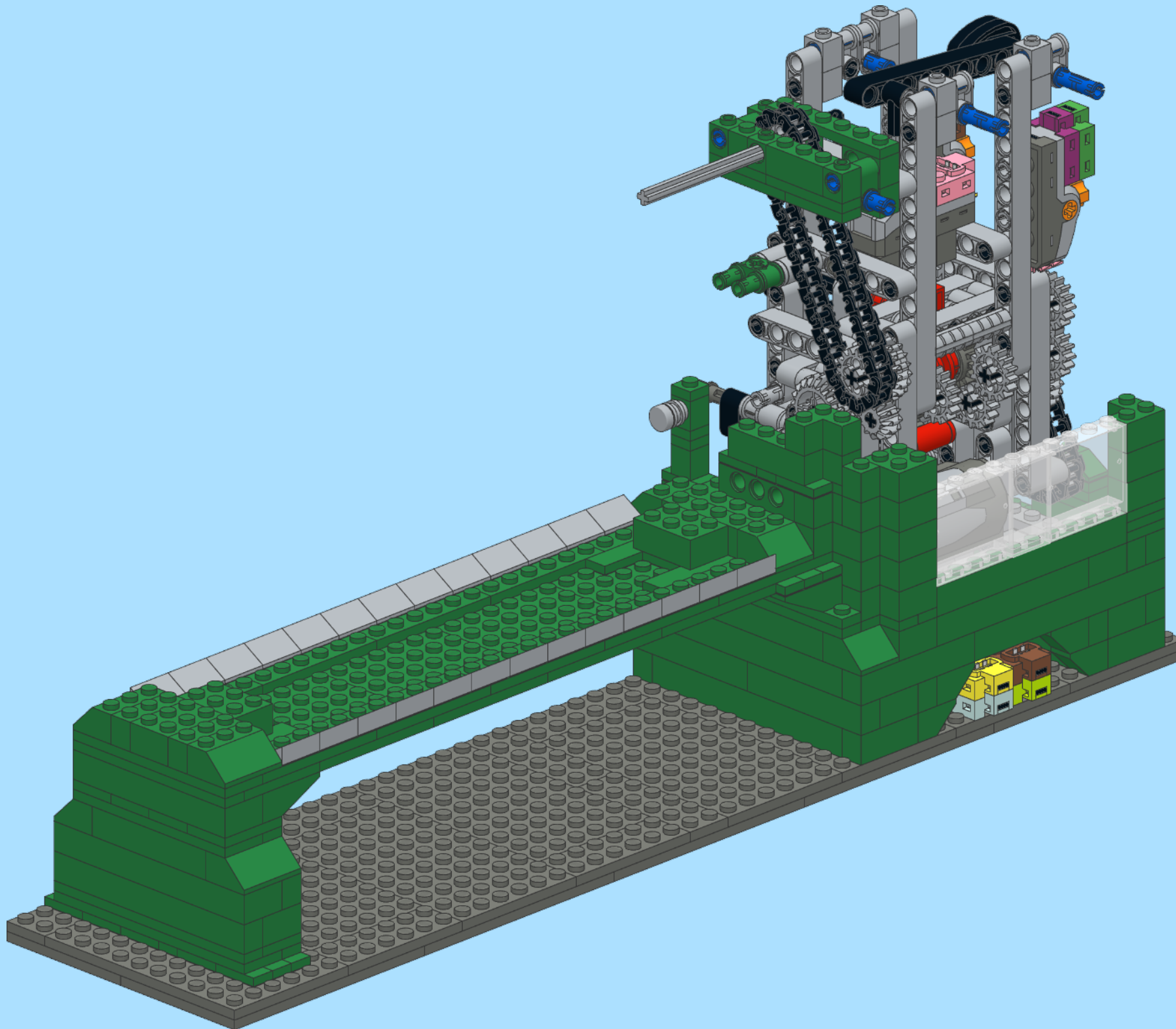
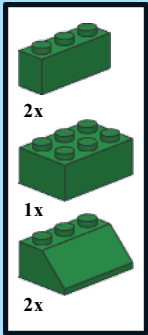

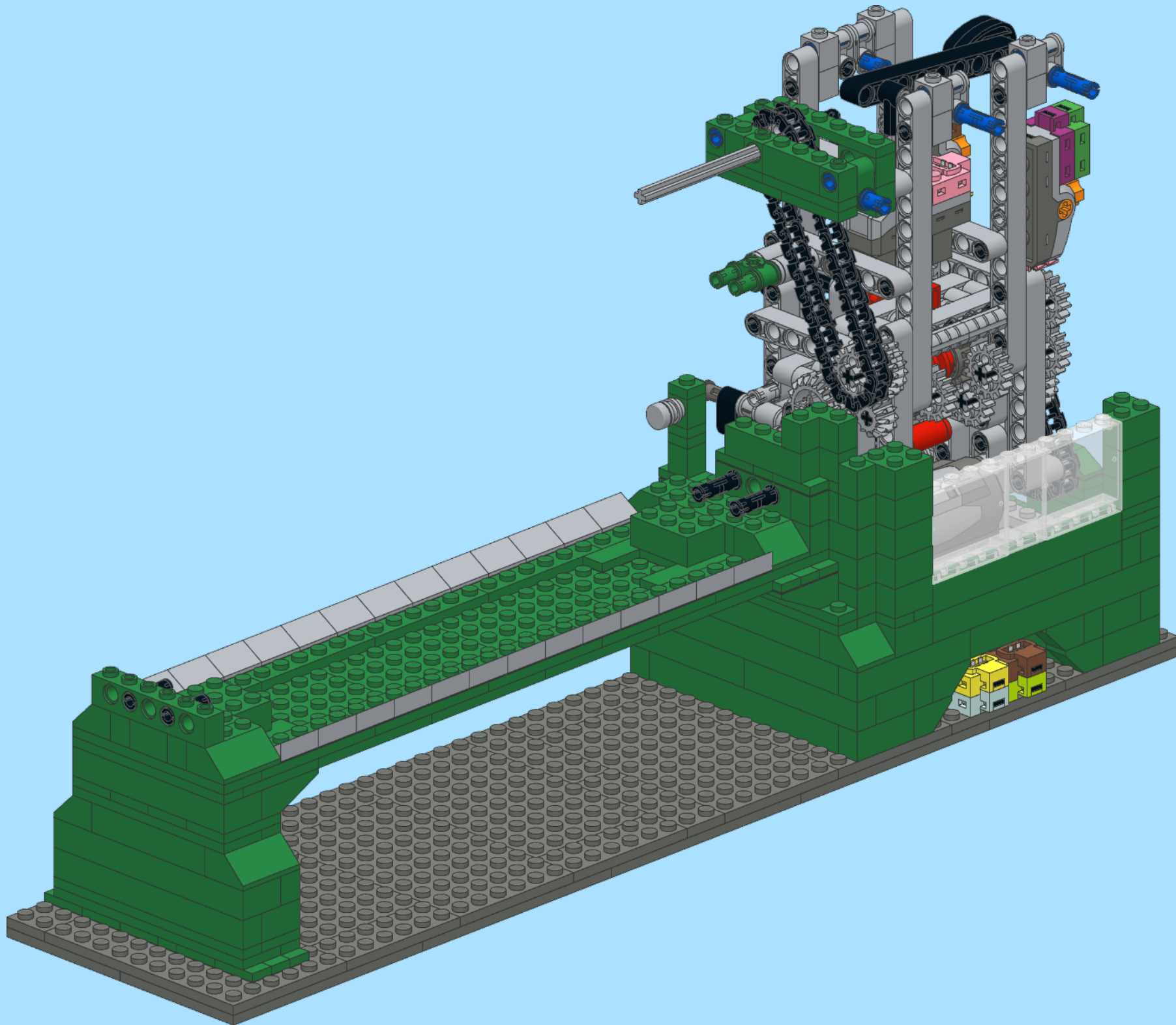
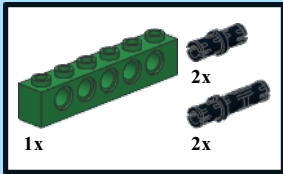

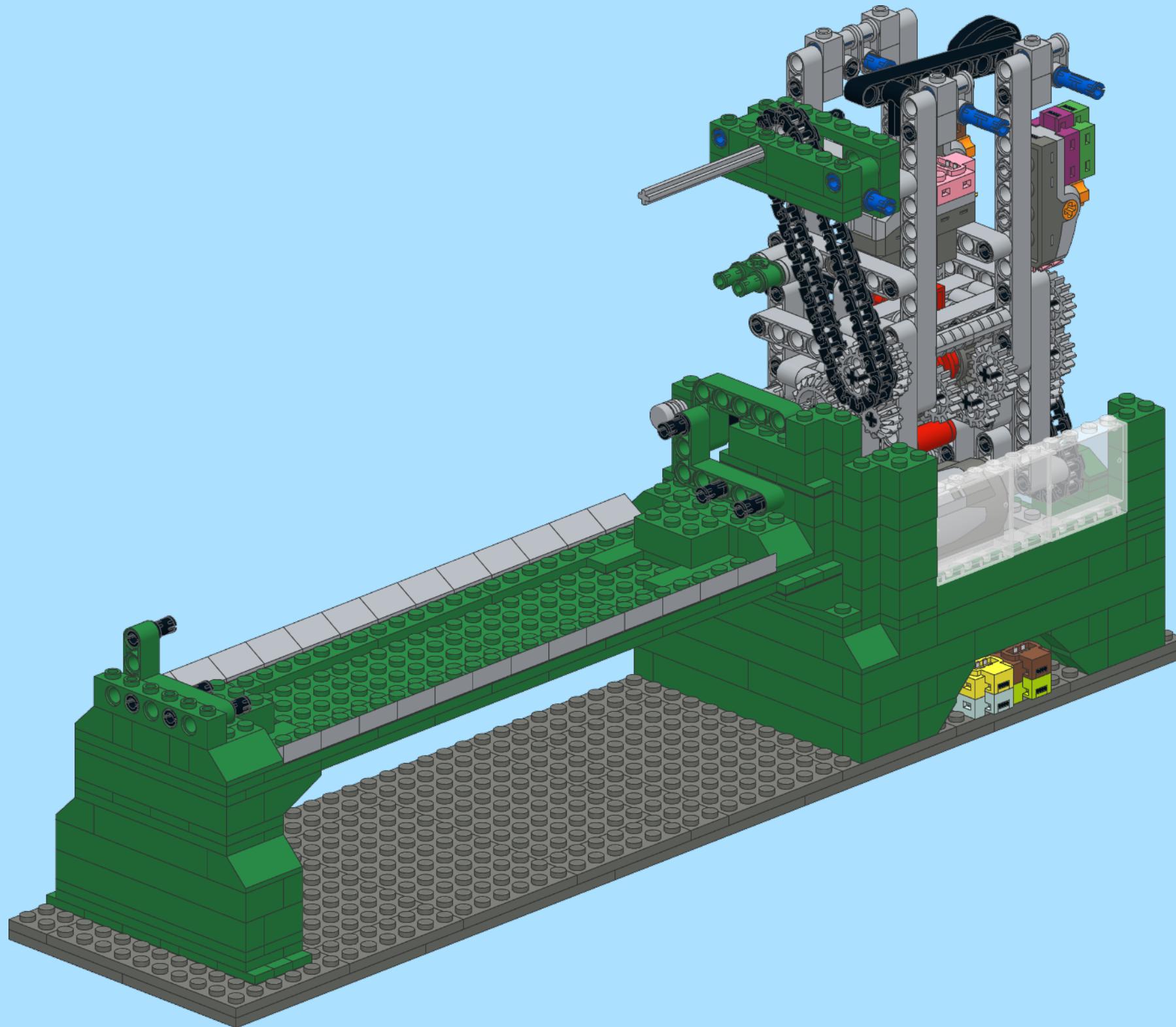
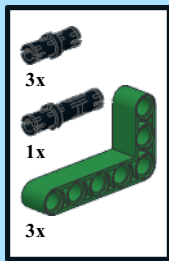

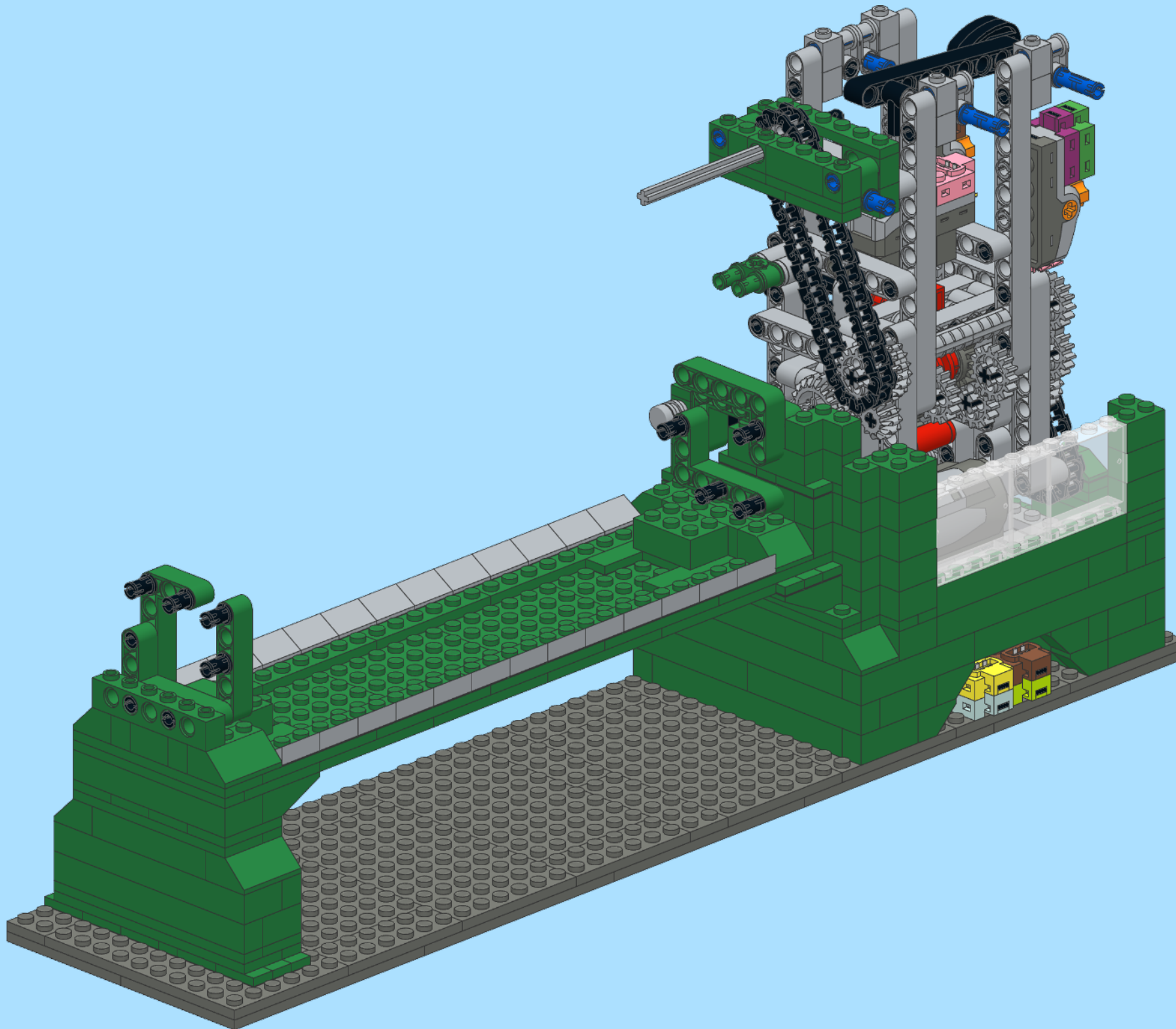

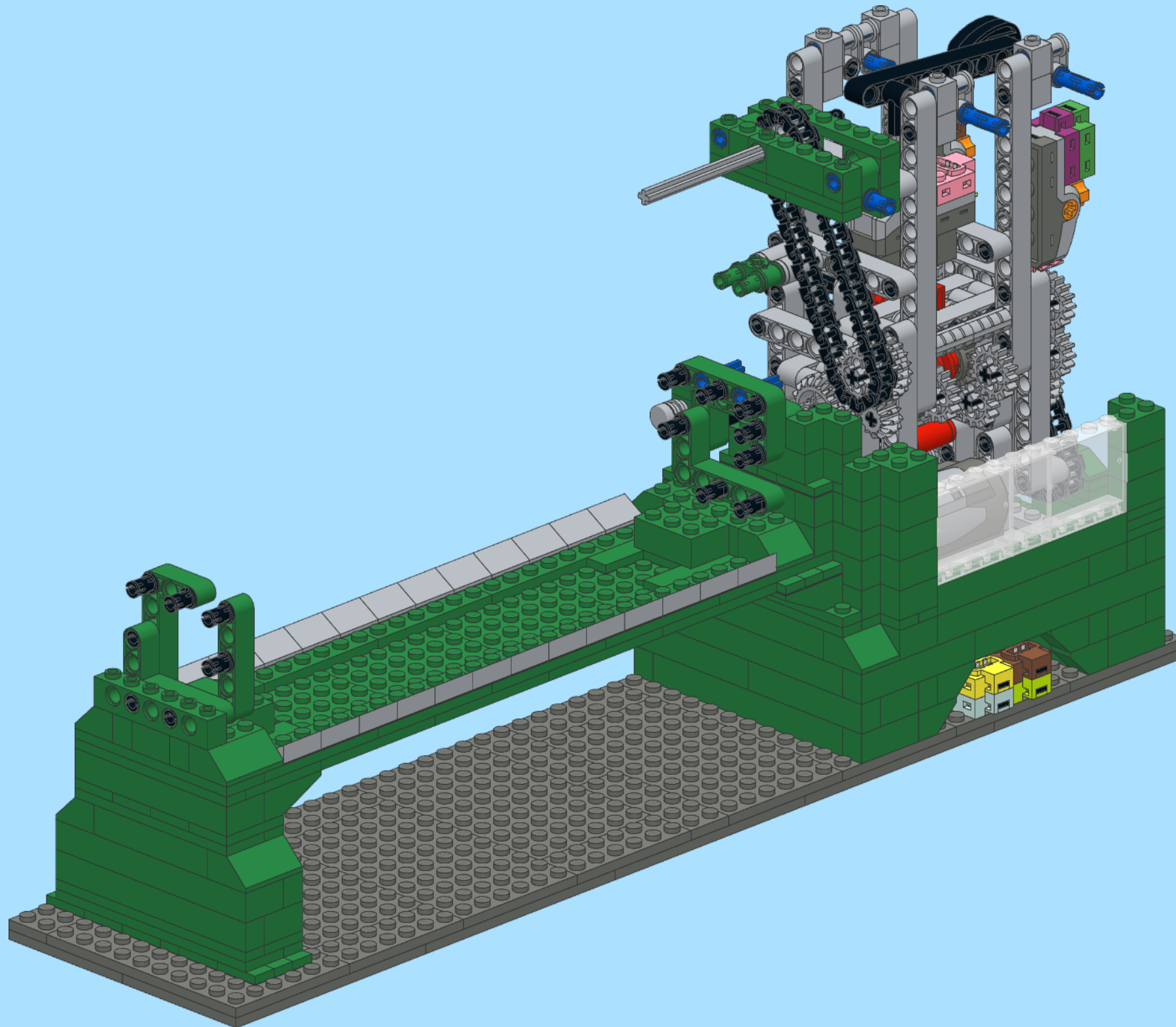

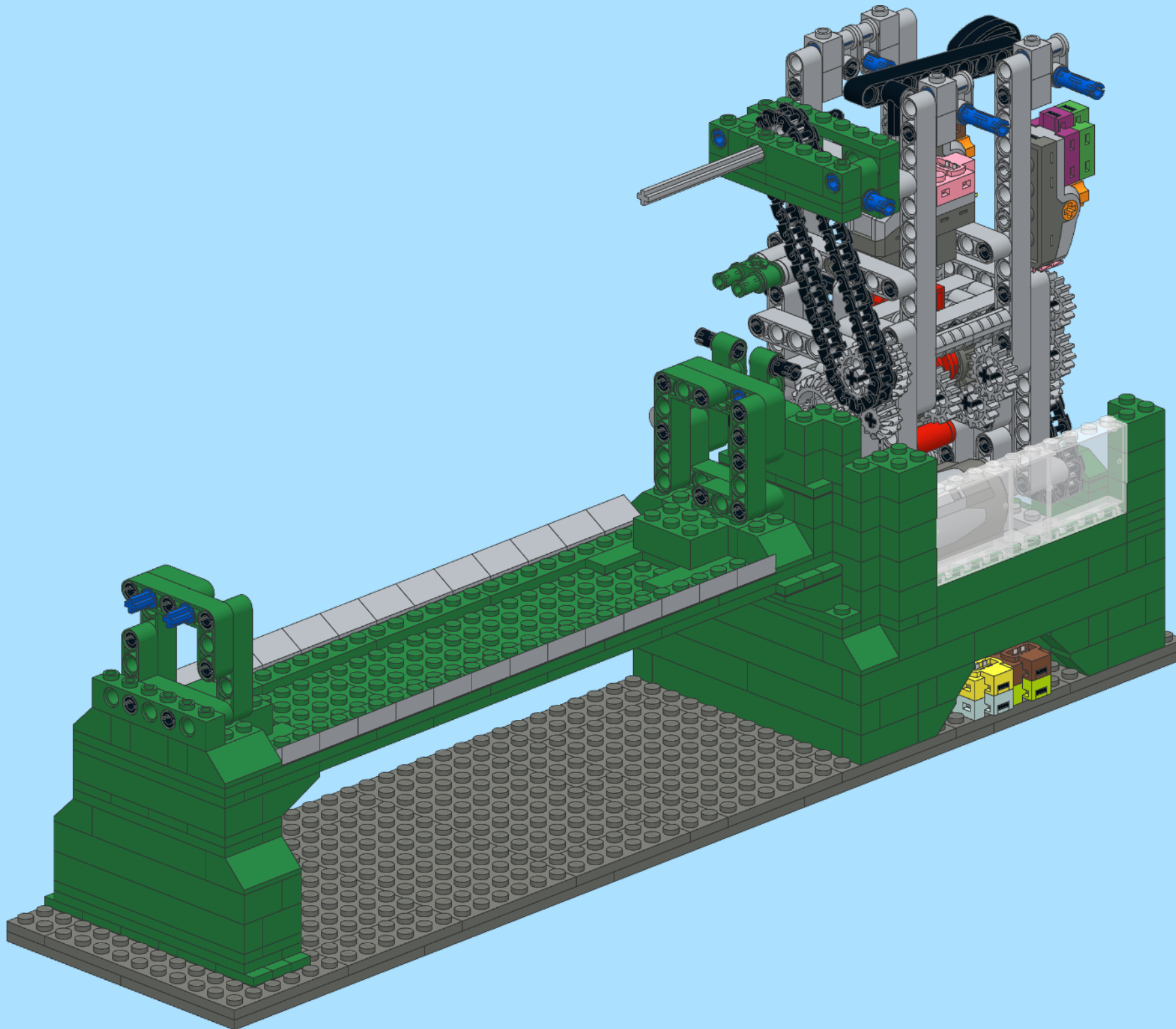
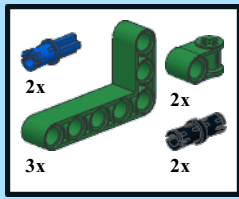



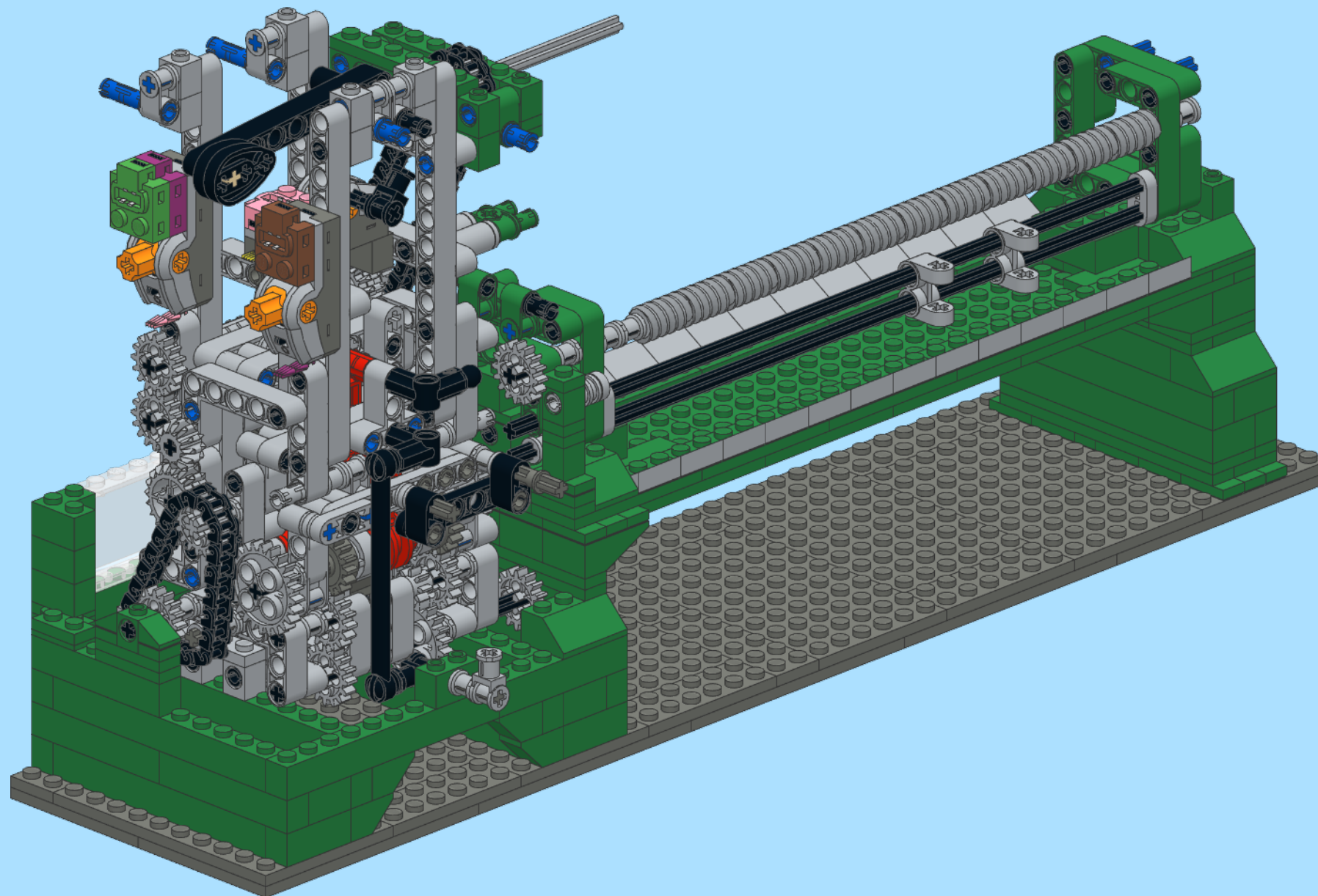
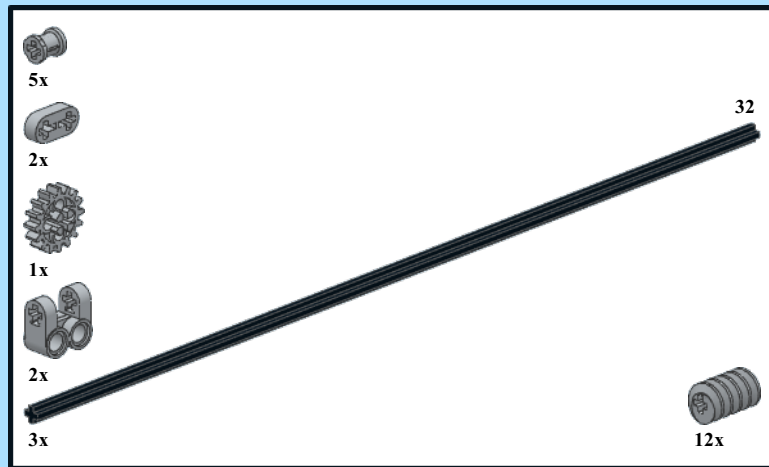

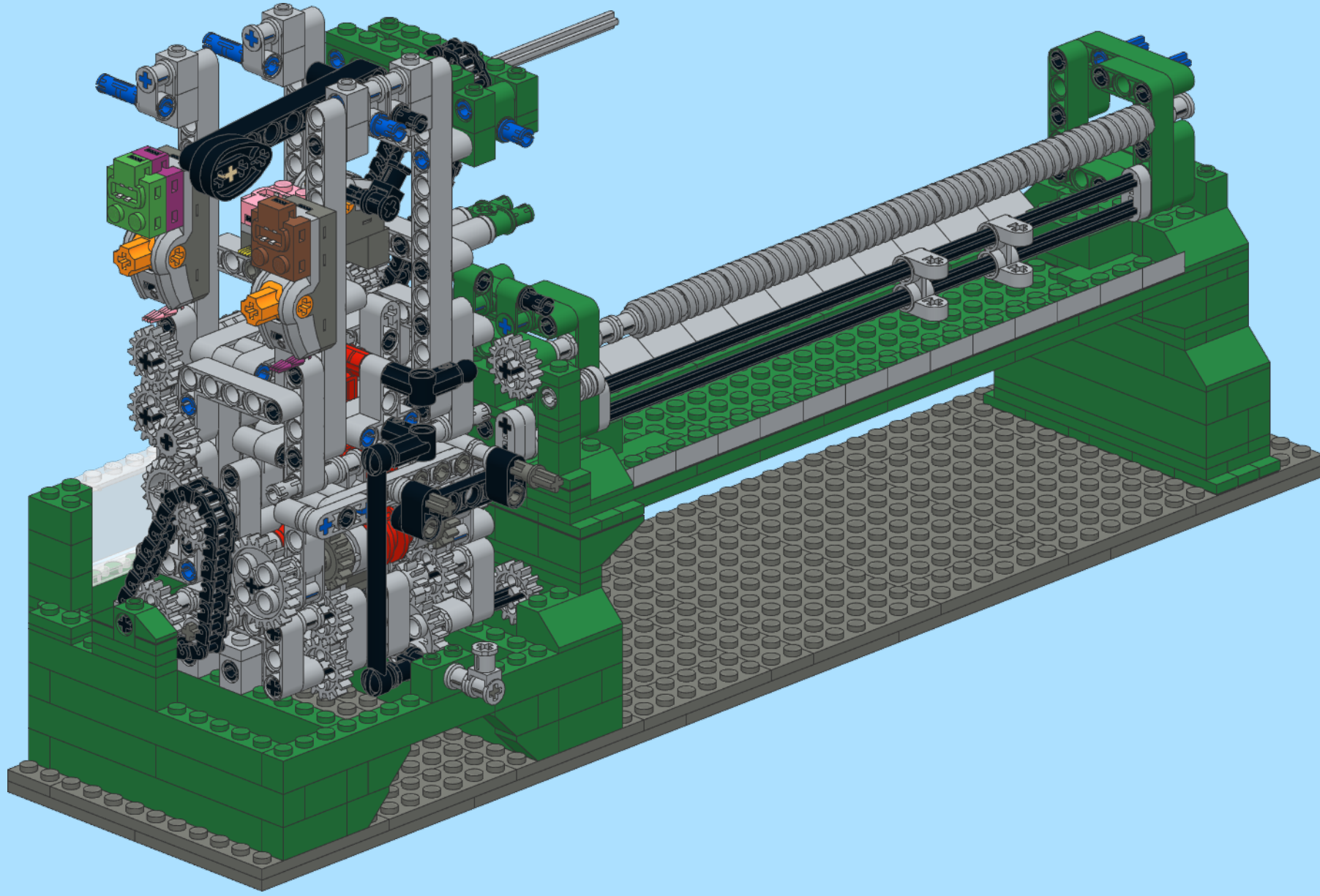
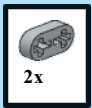

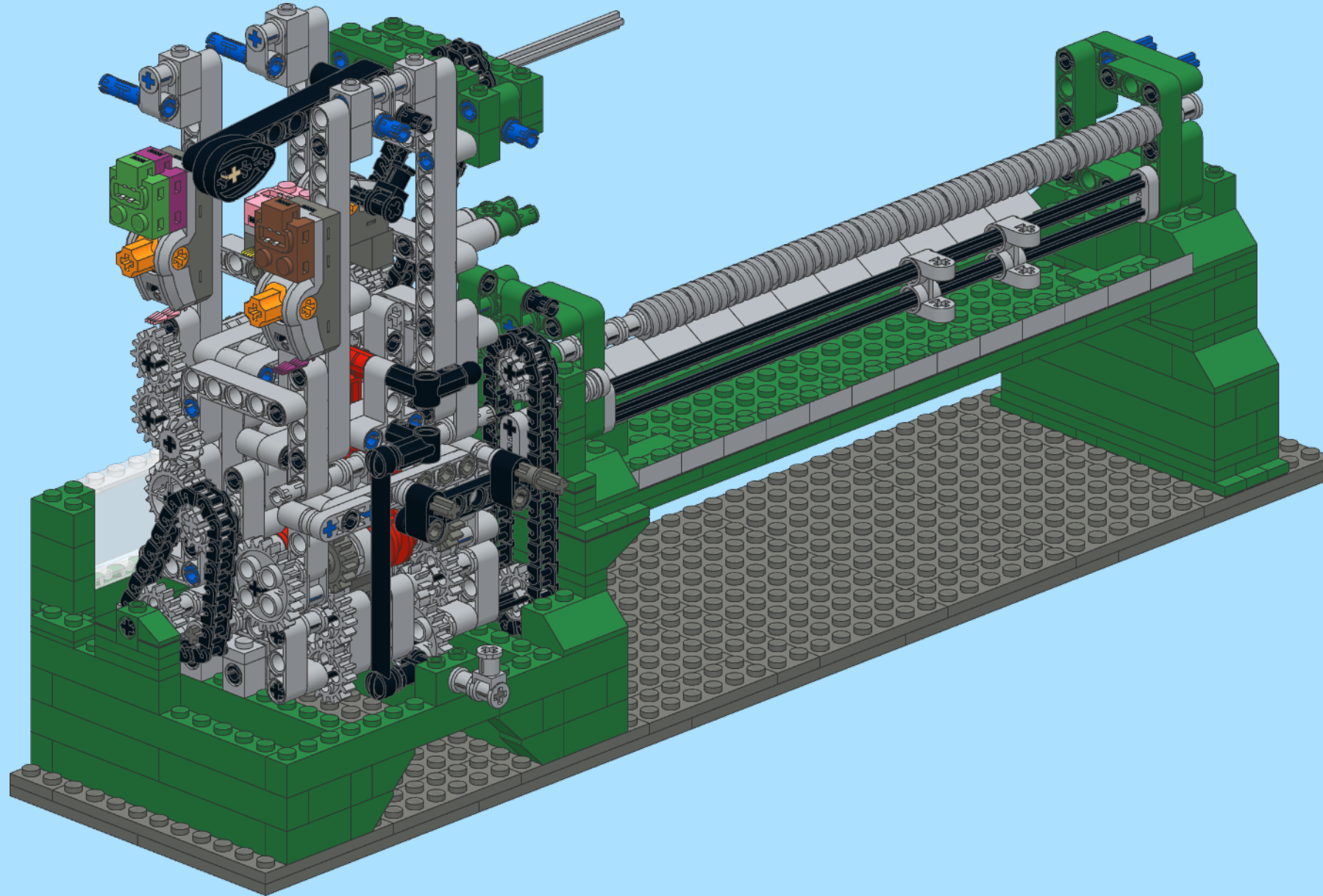

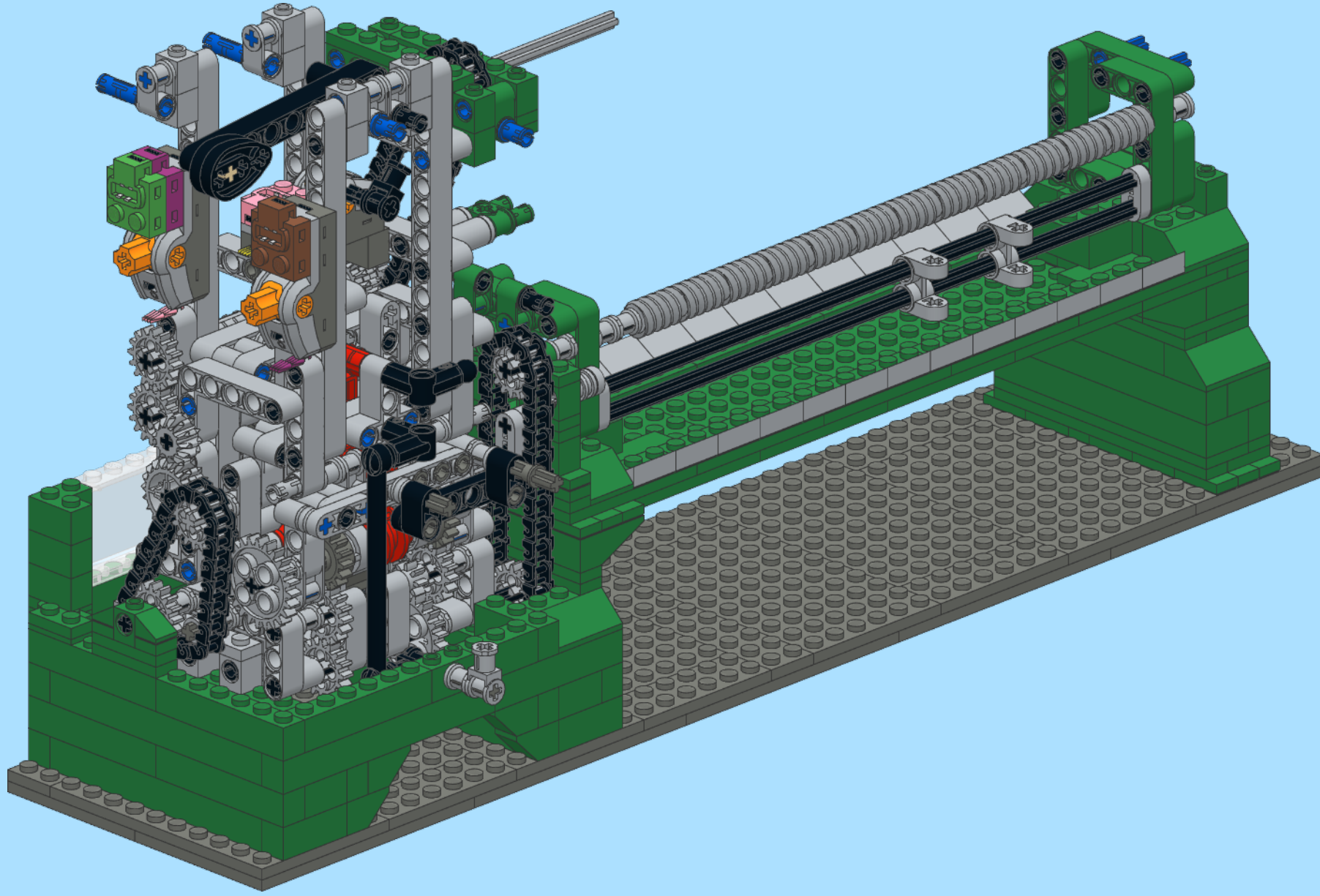
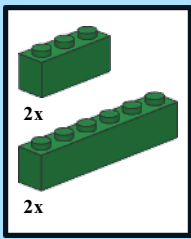

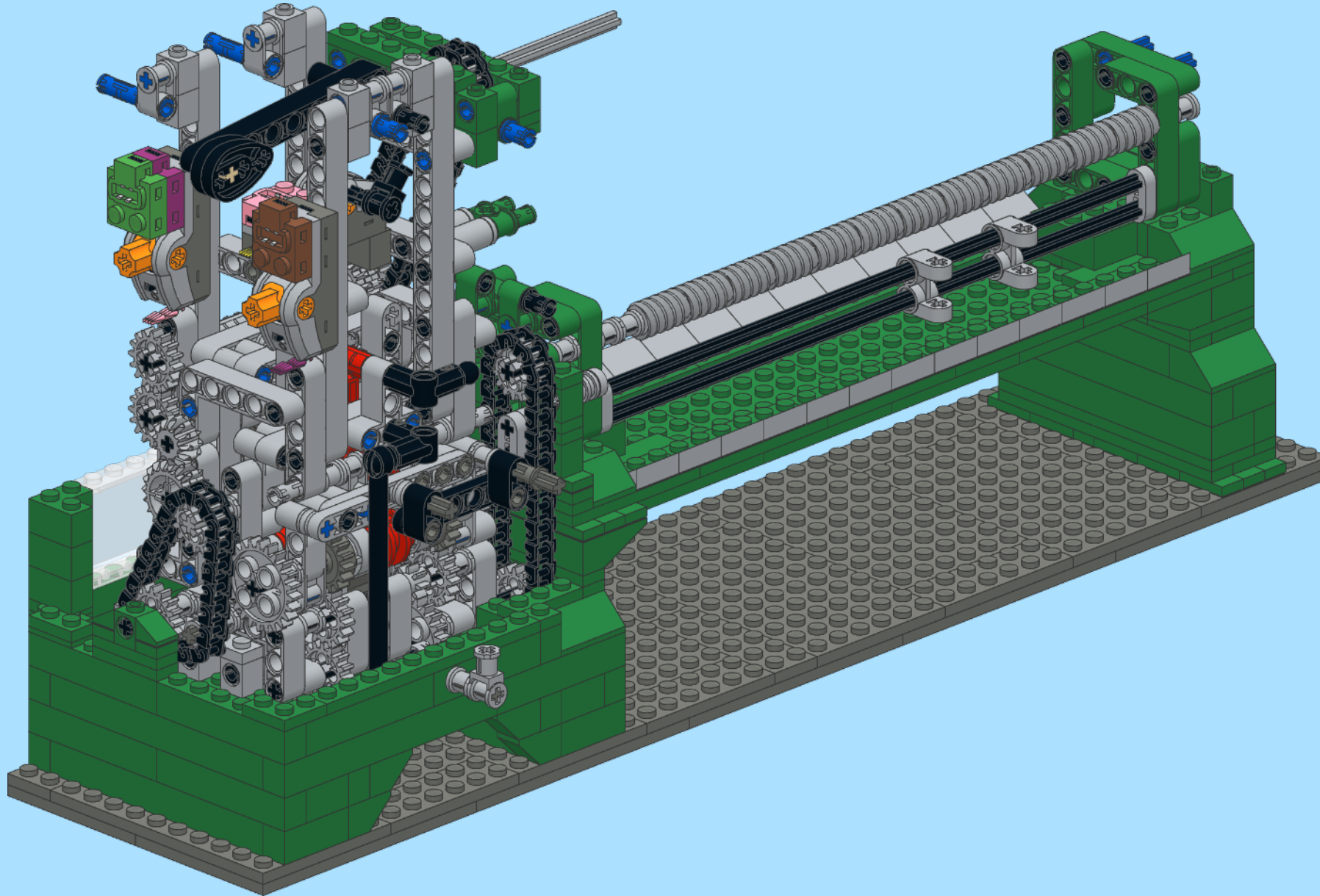
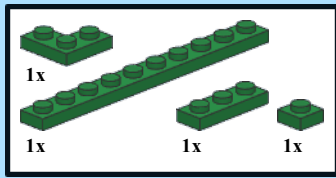

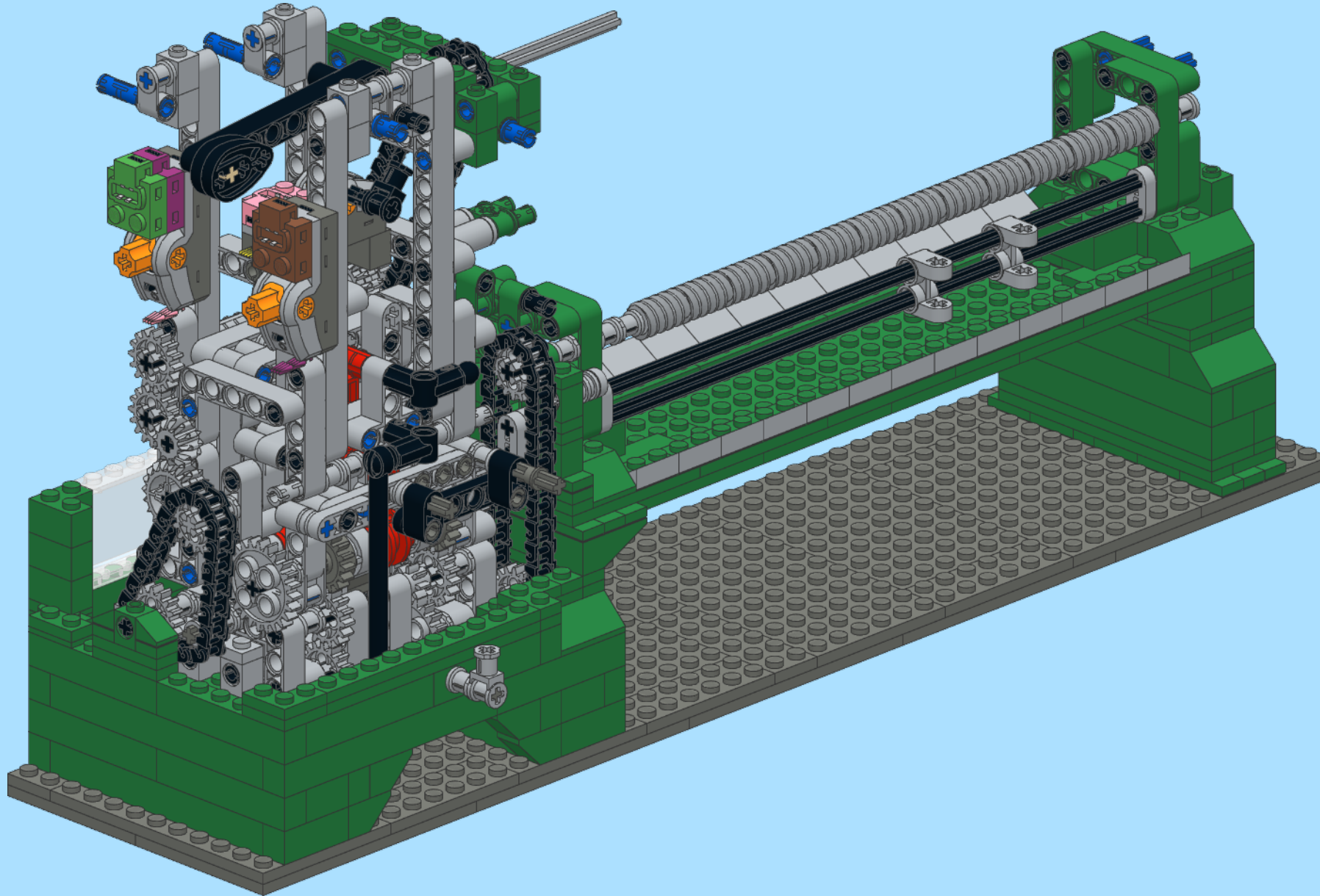
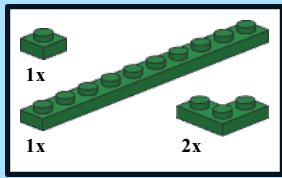

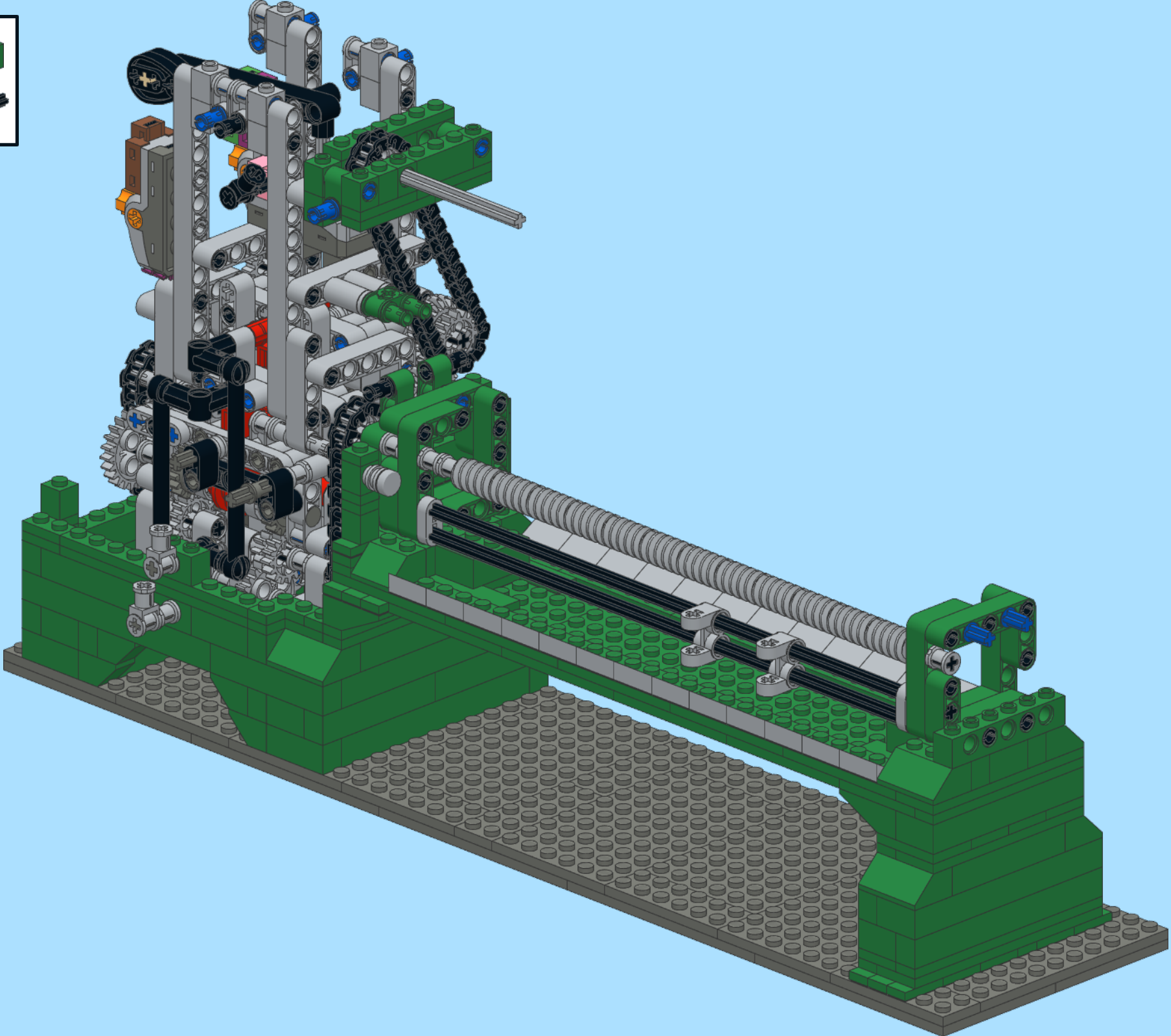
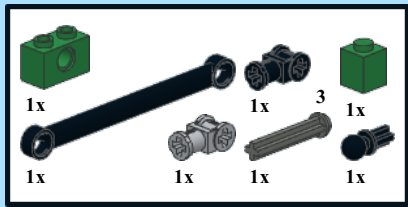

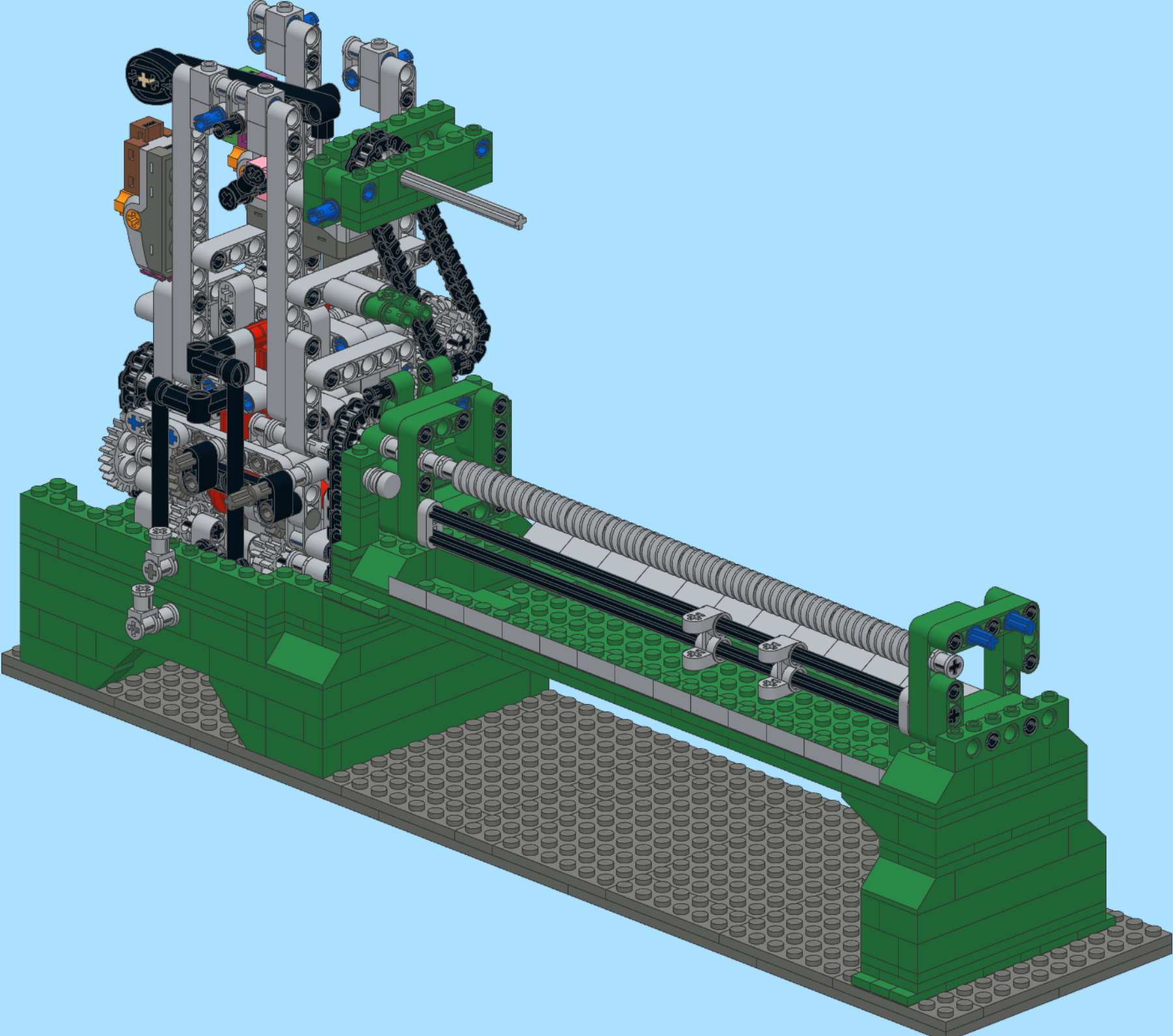
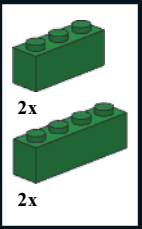



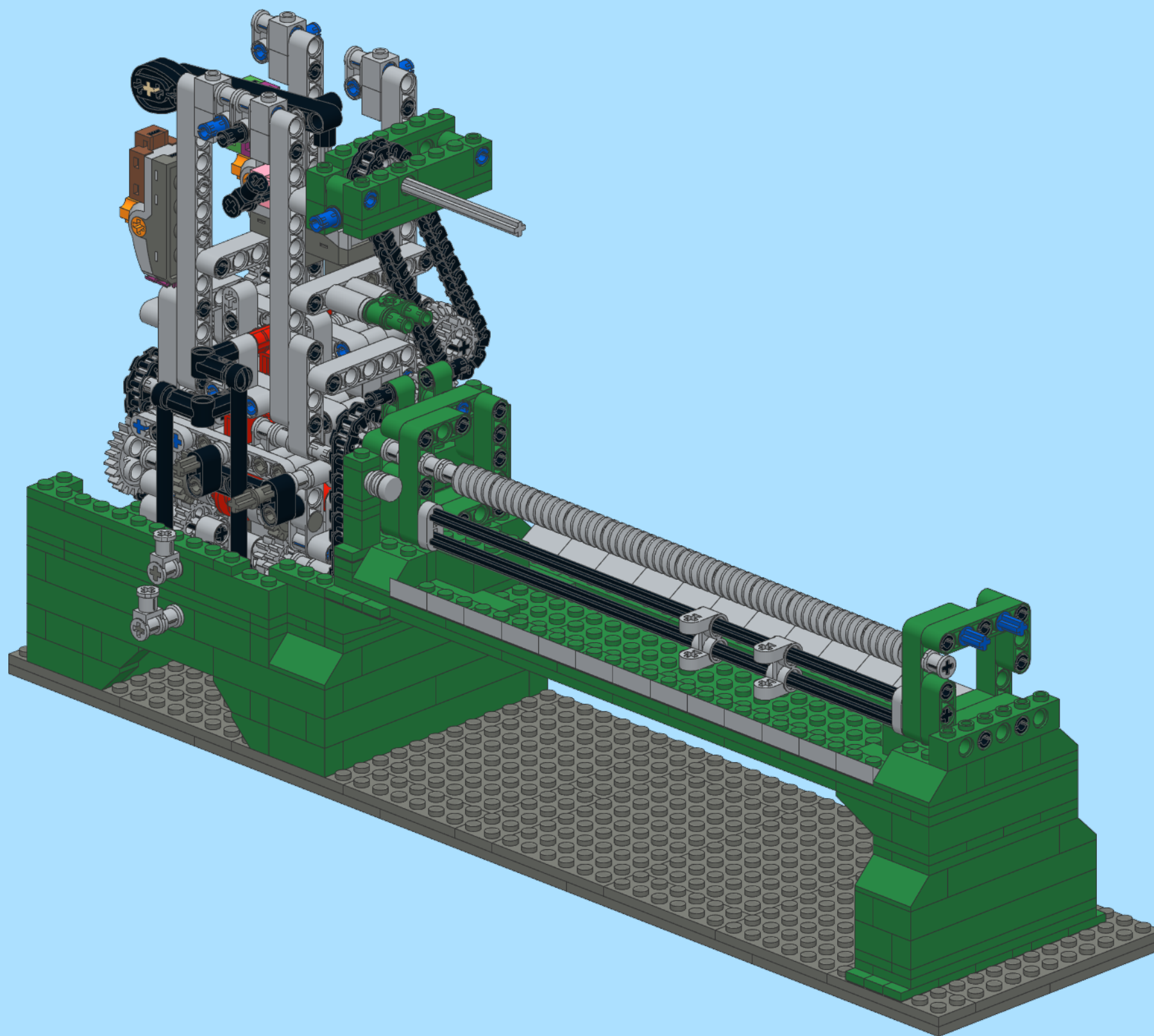
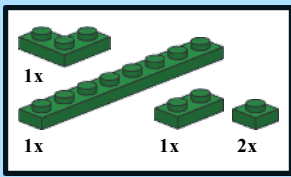

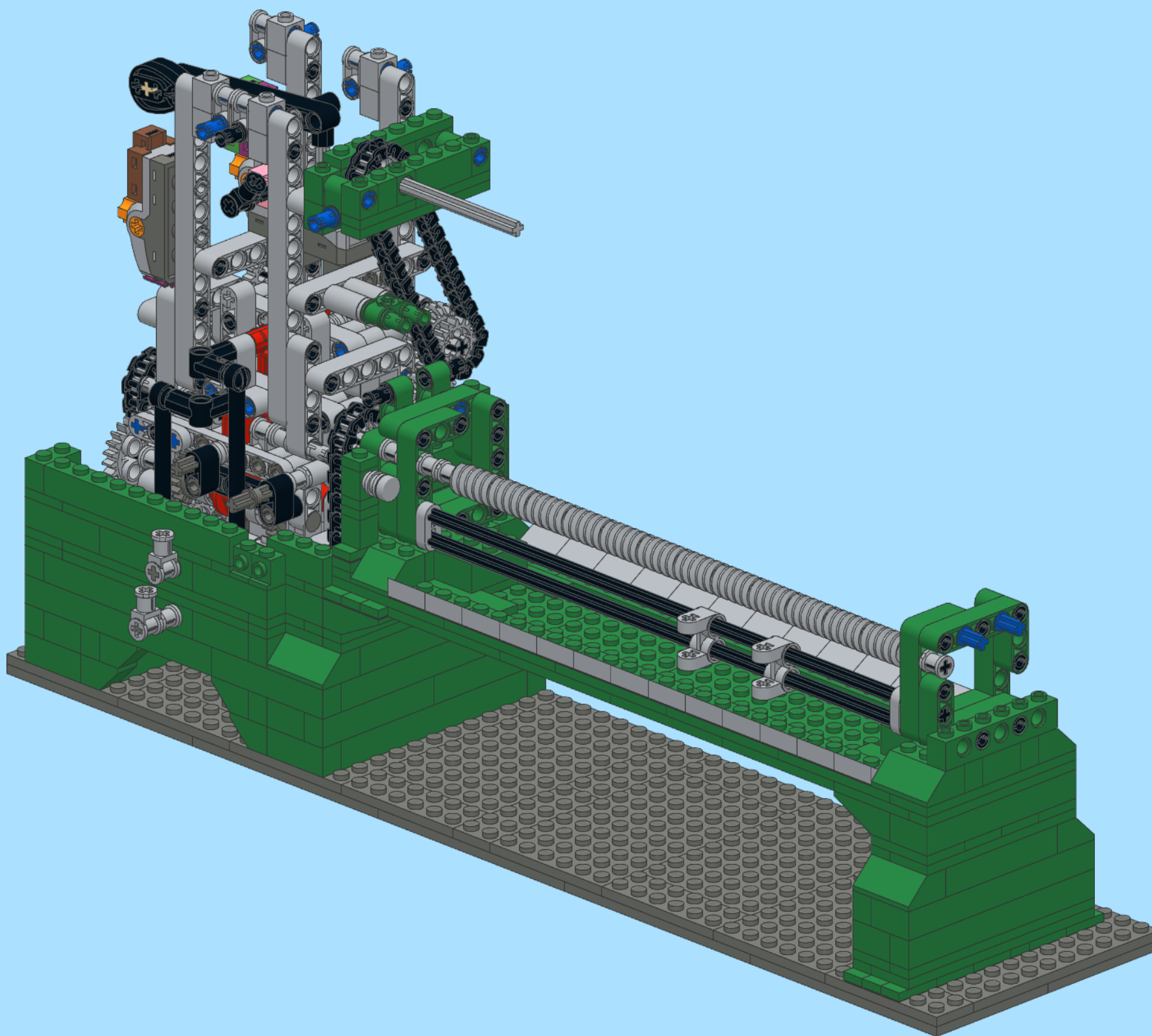
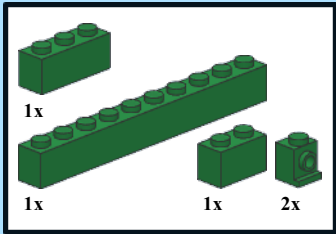

-  2x
-  2x
-  1x
-  2x
-  2x
-  1x

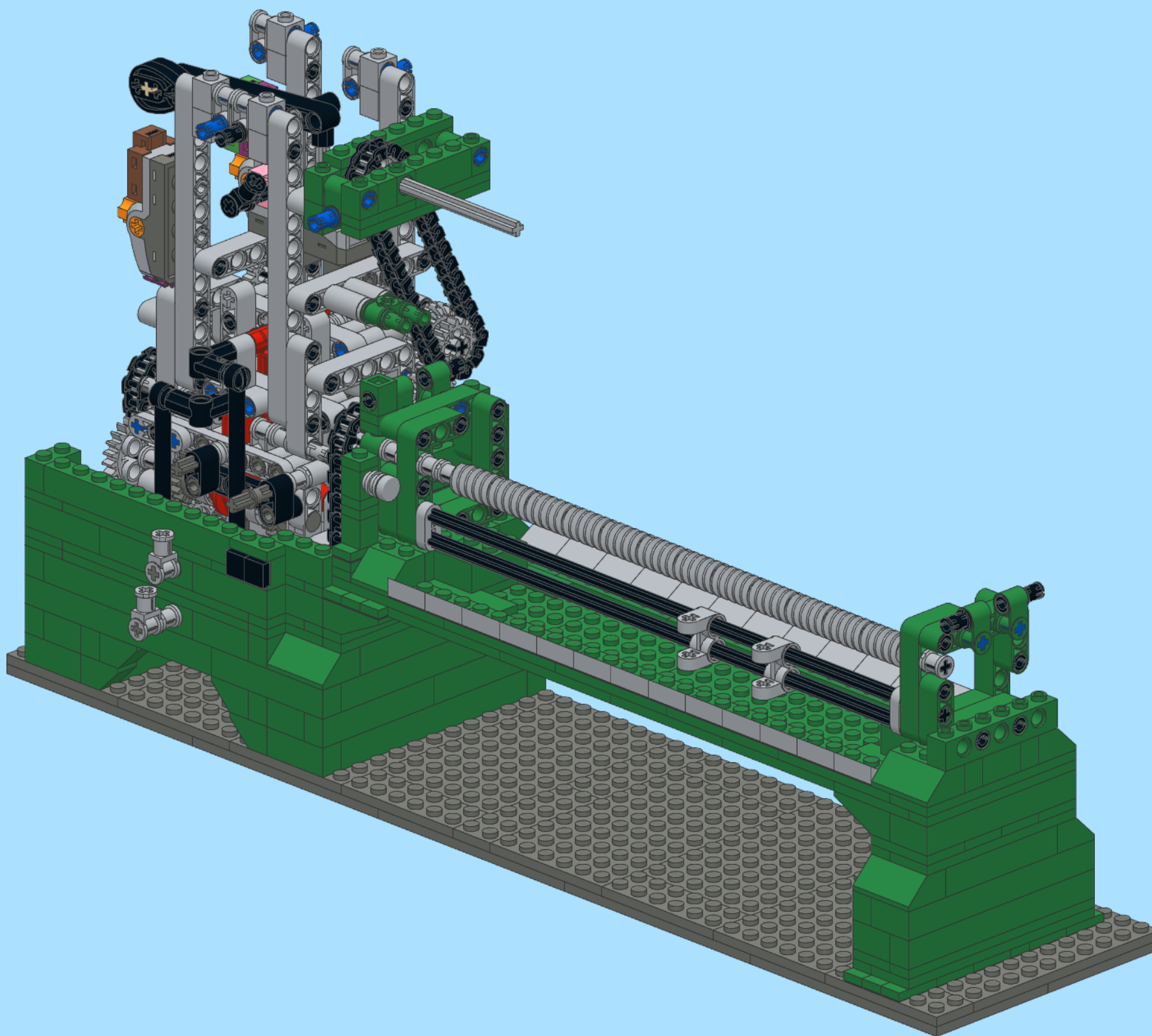

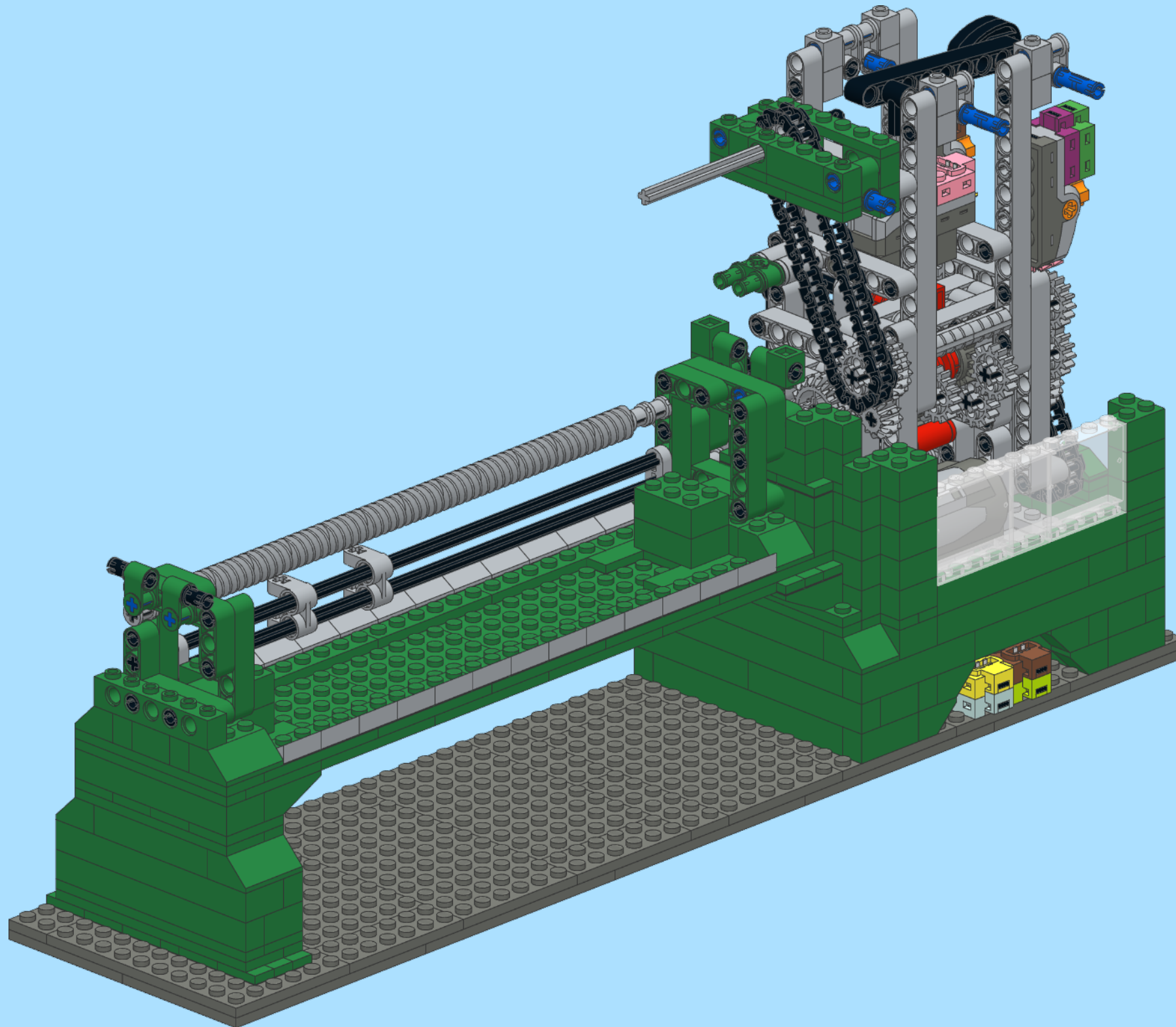
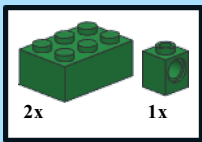

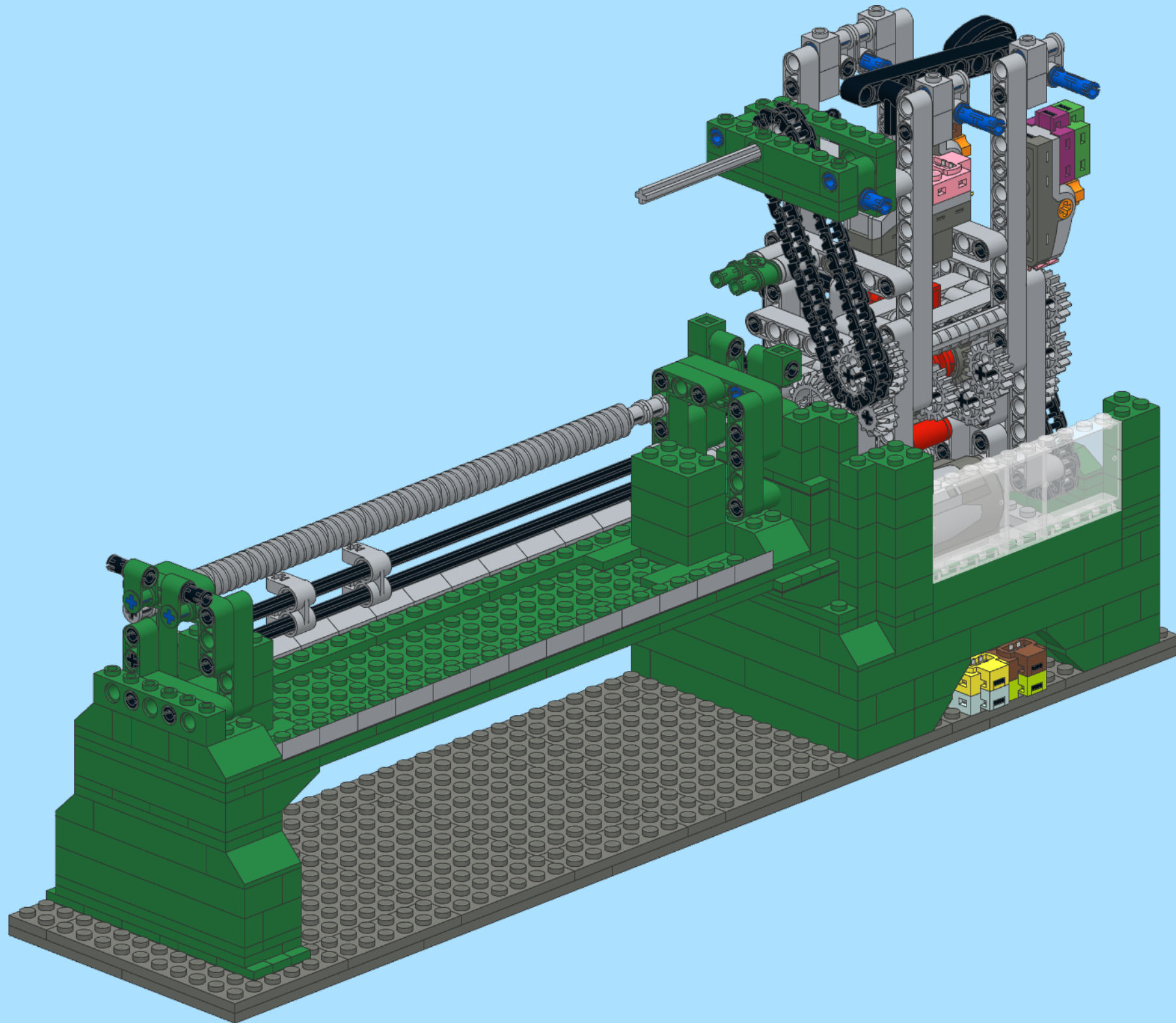
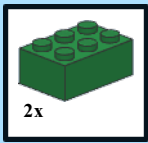

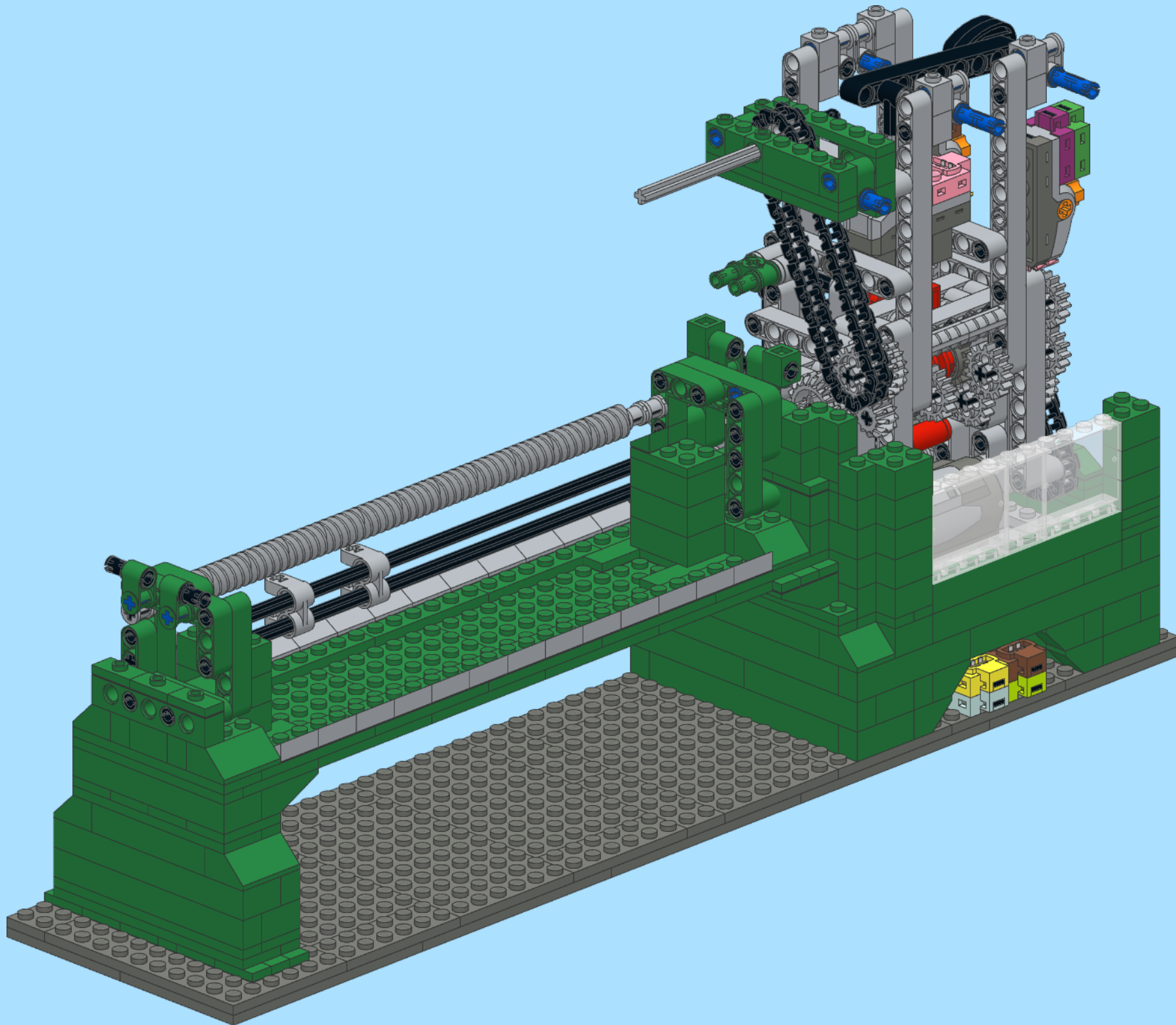
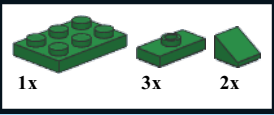

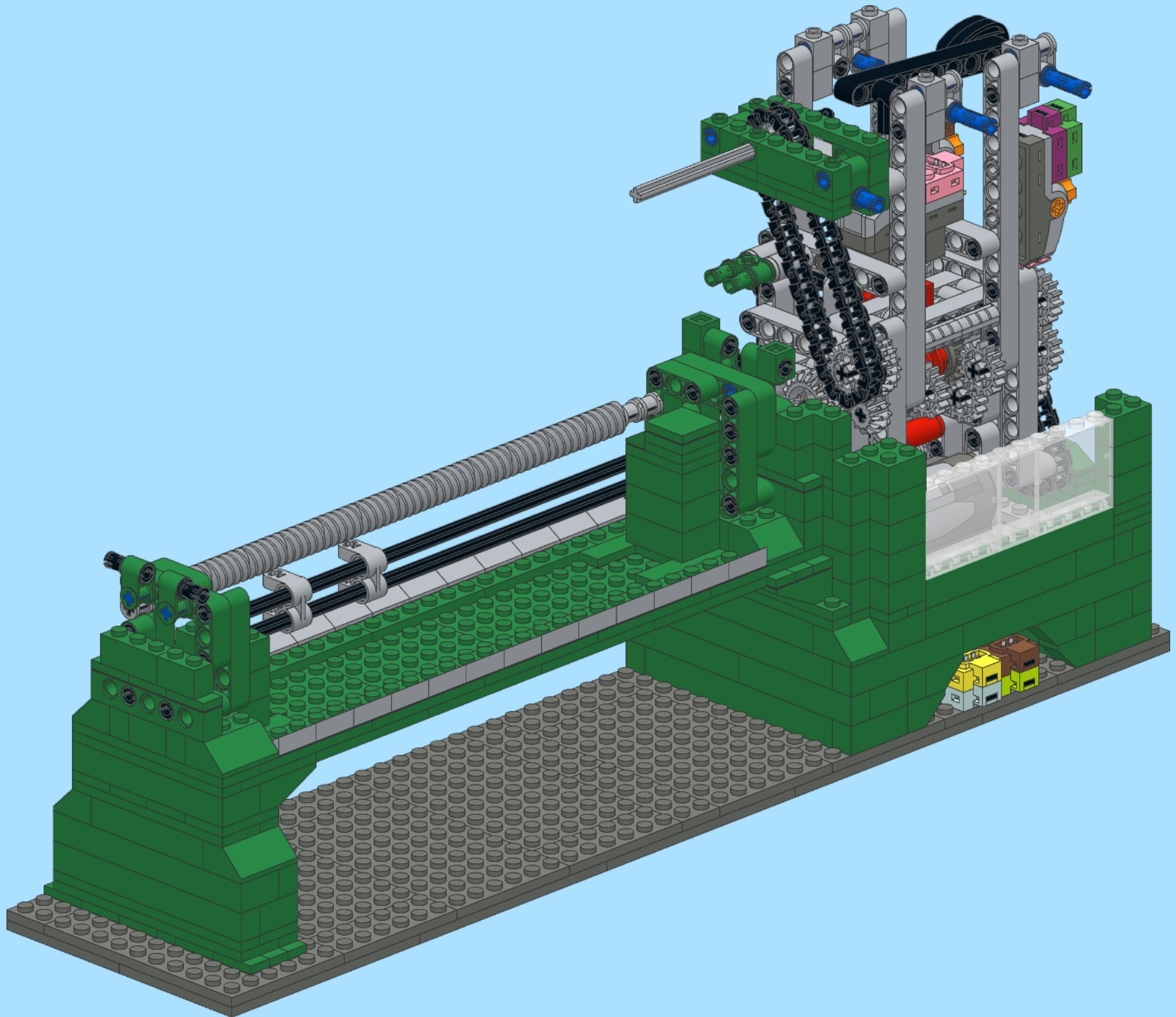
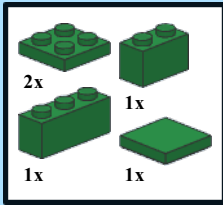

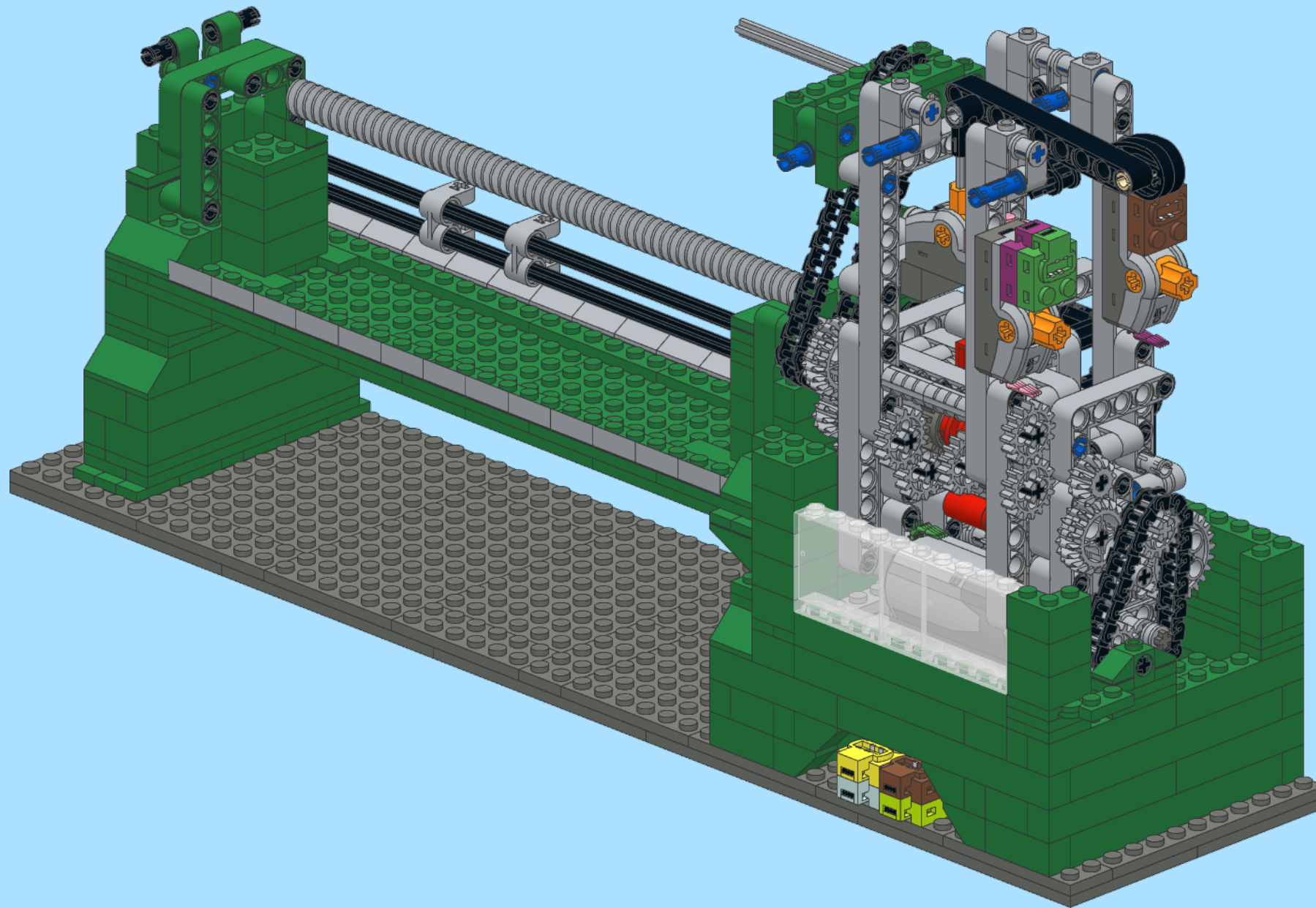
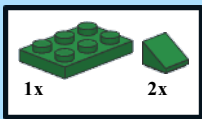



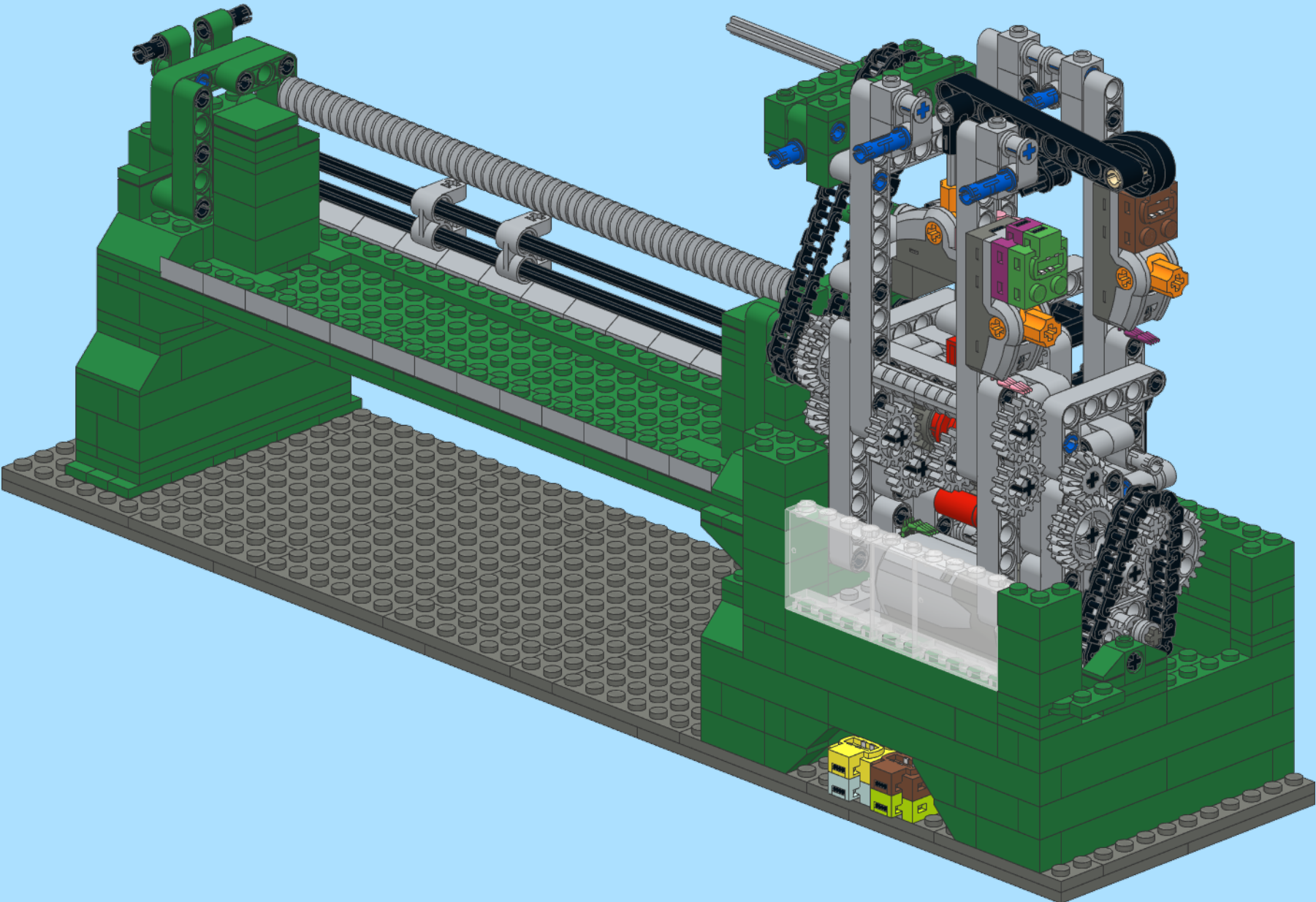
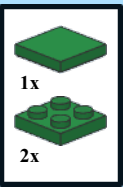

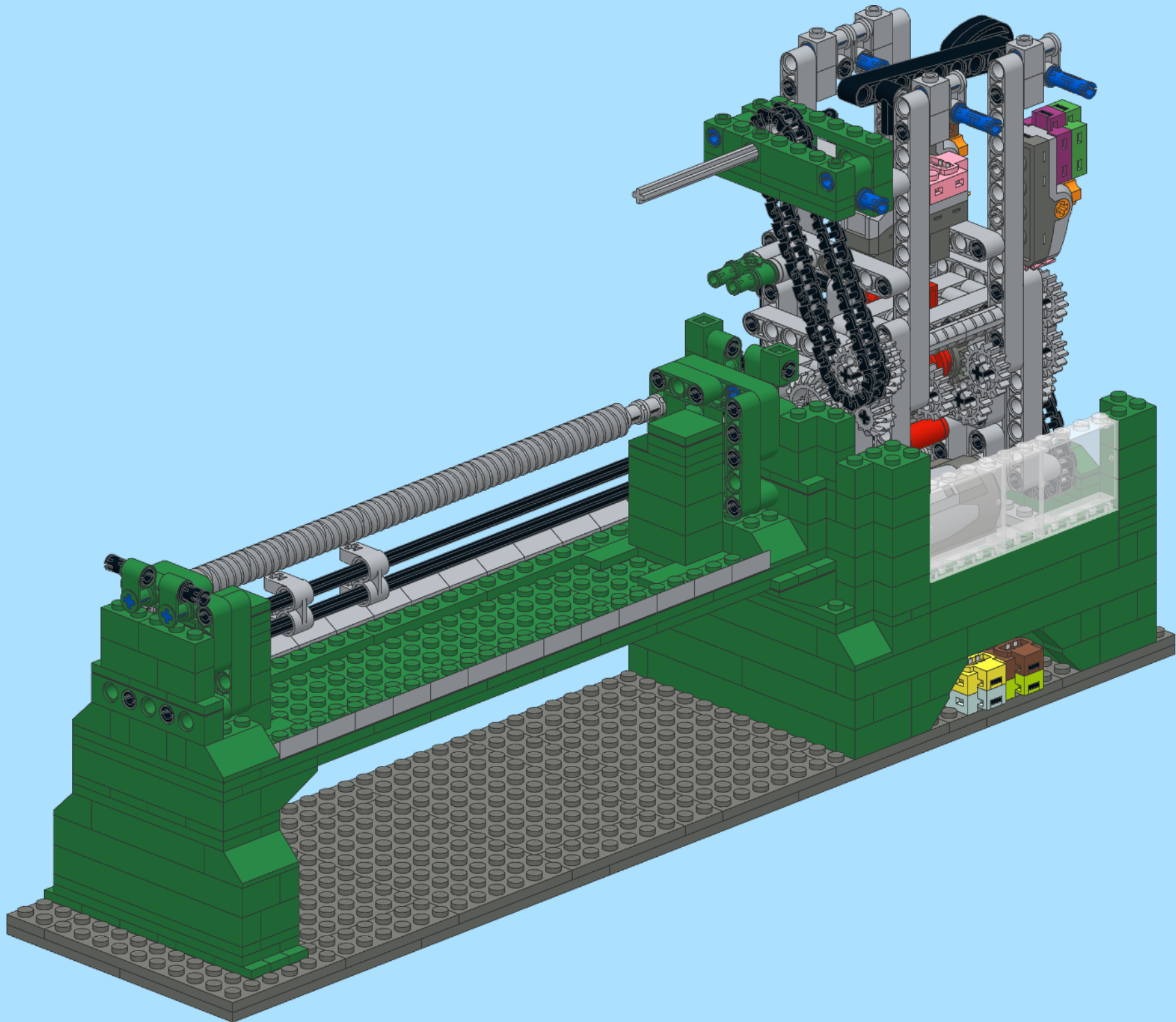
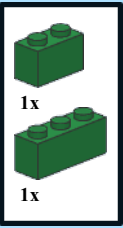

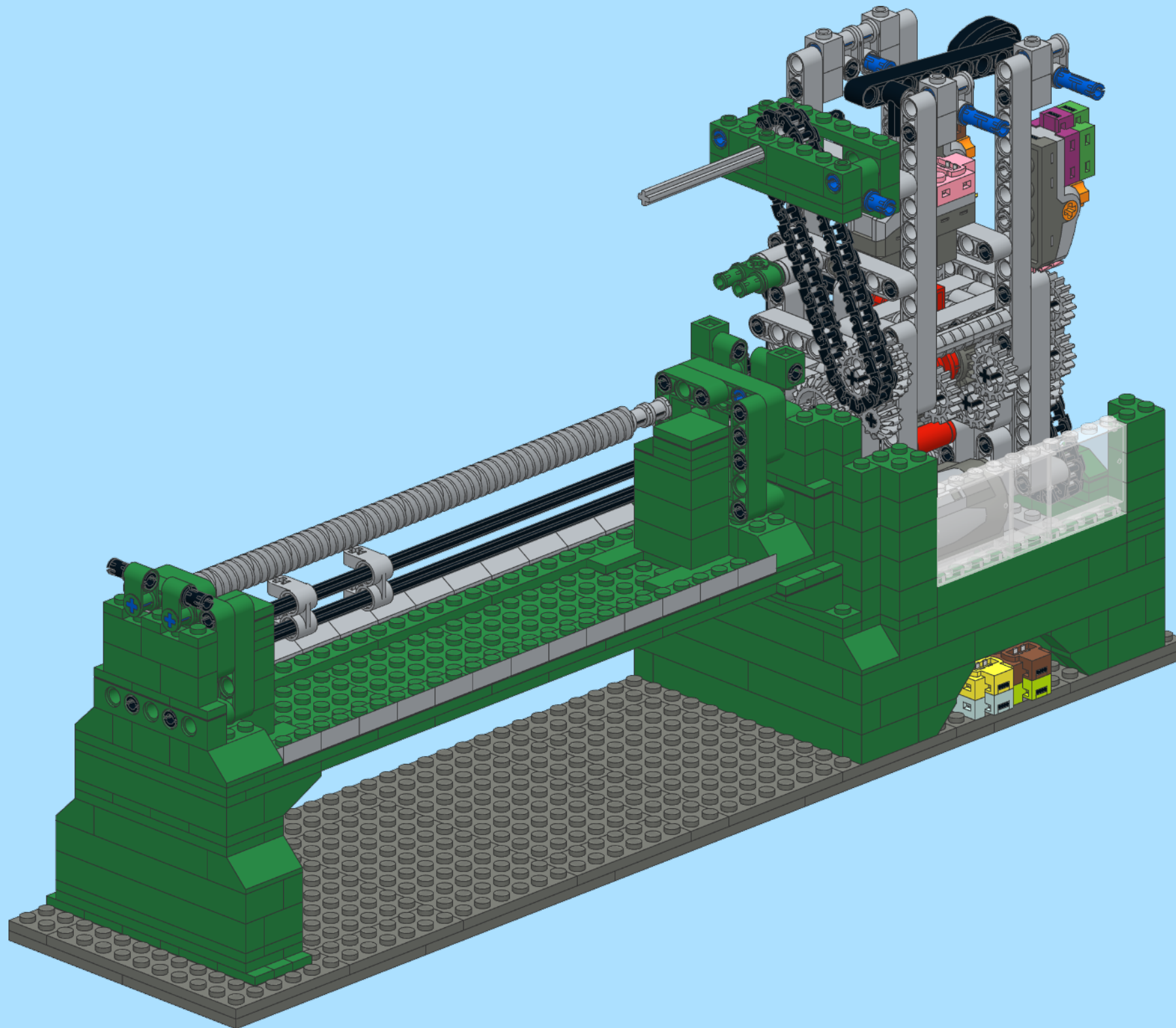

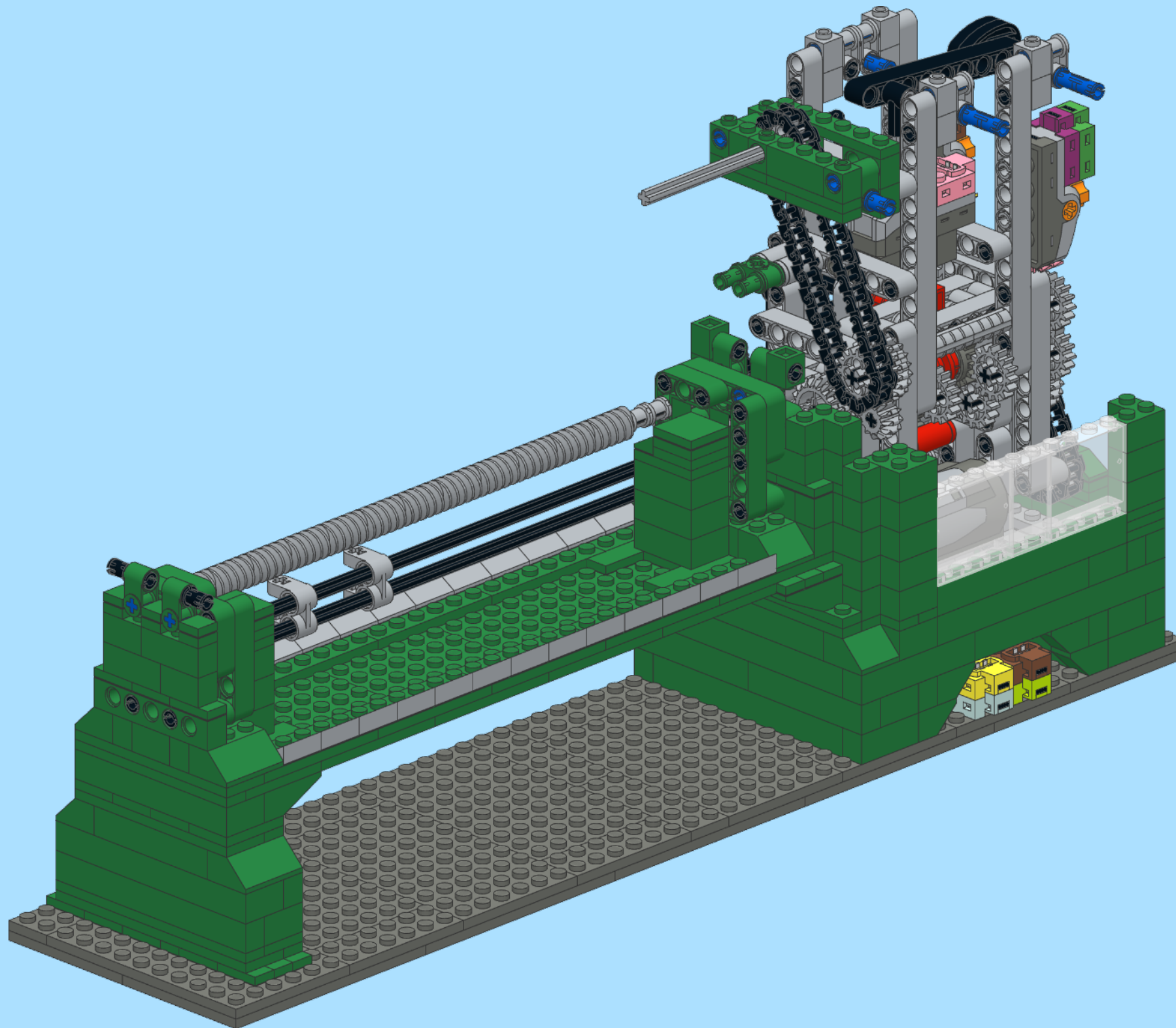

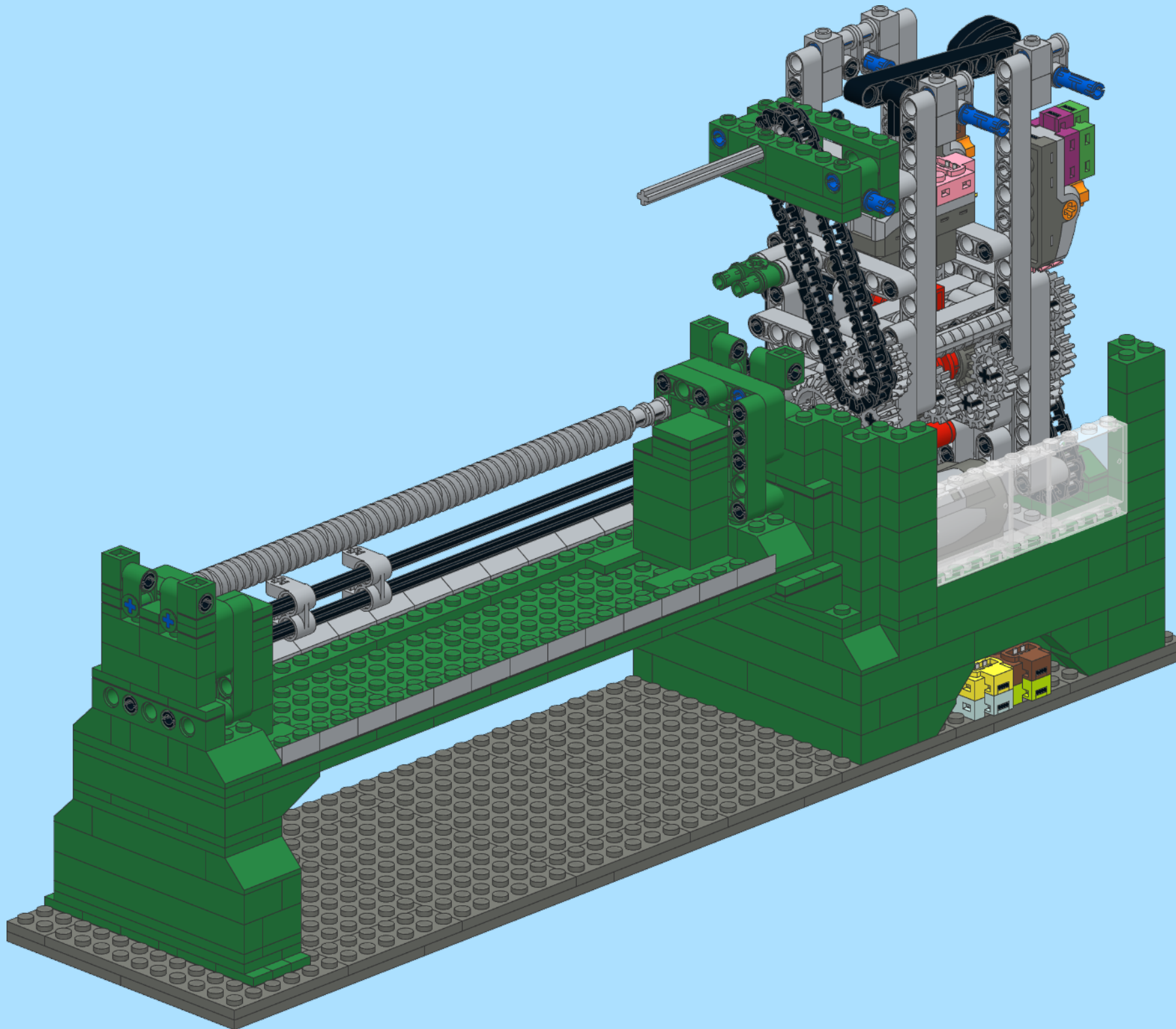
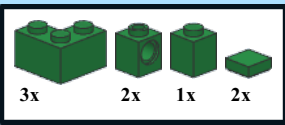

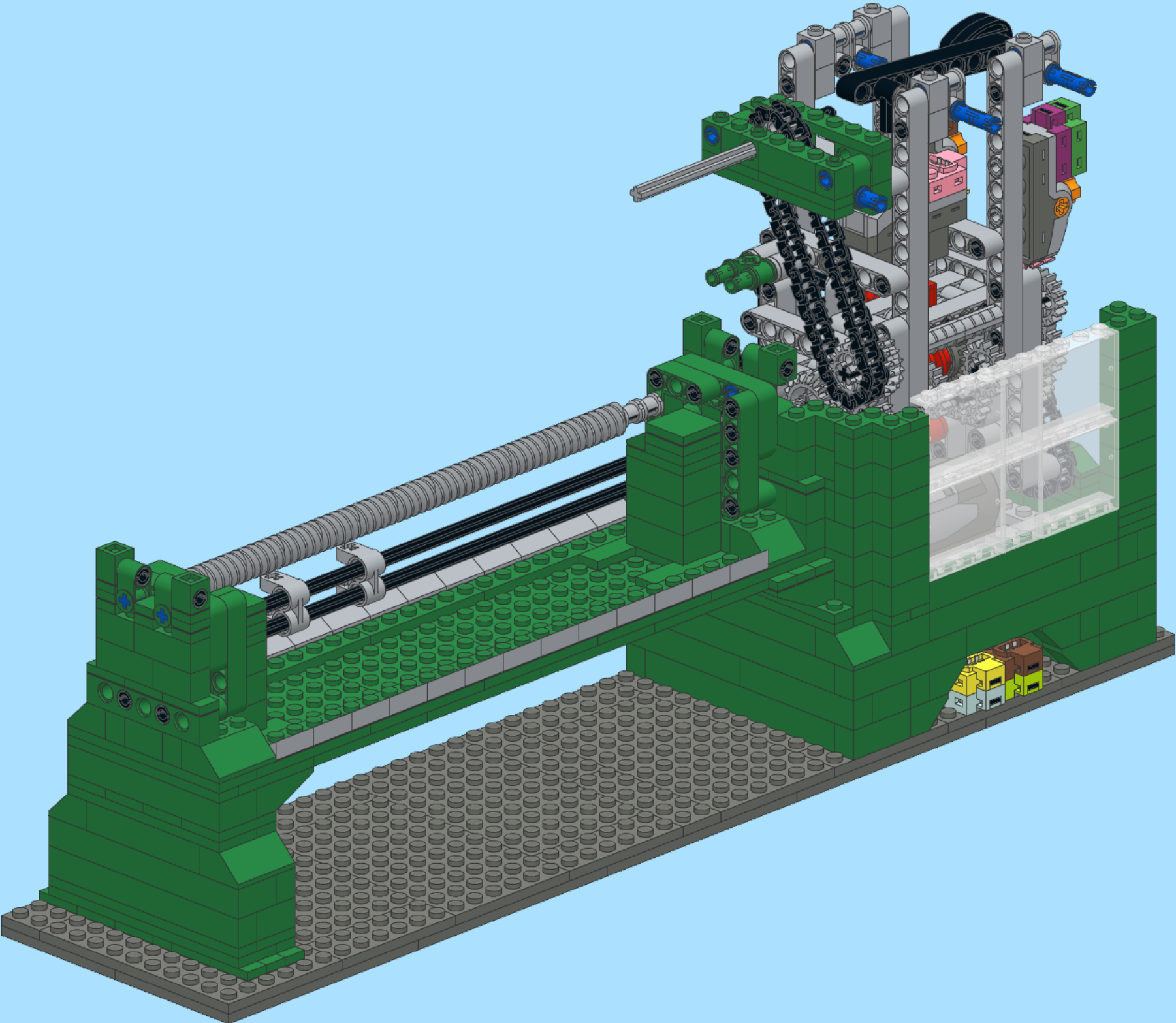
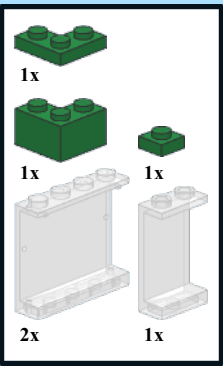

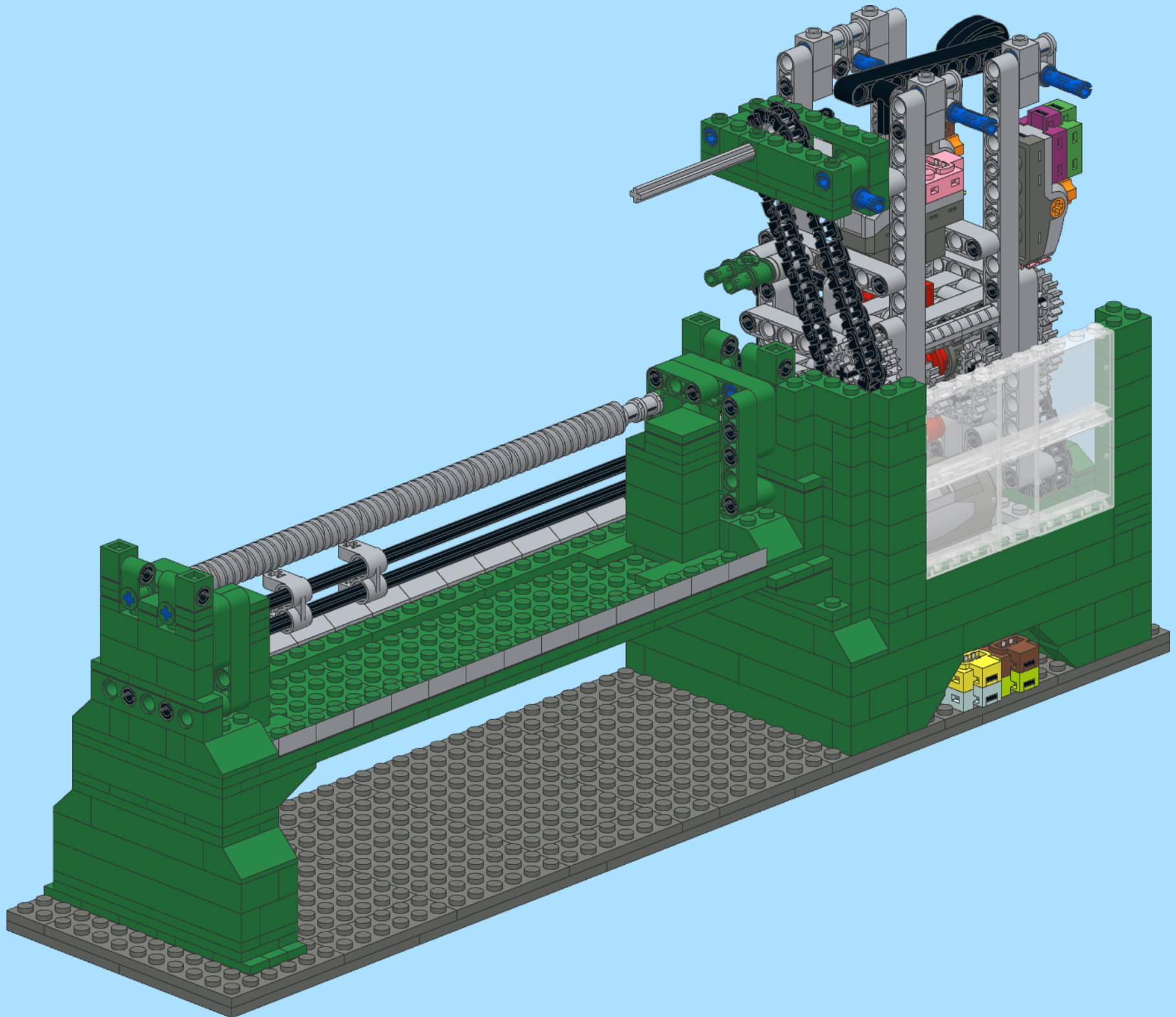
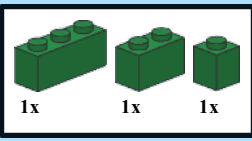

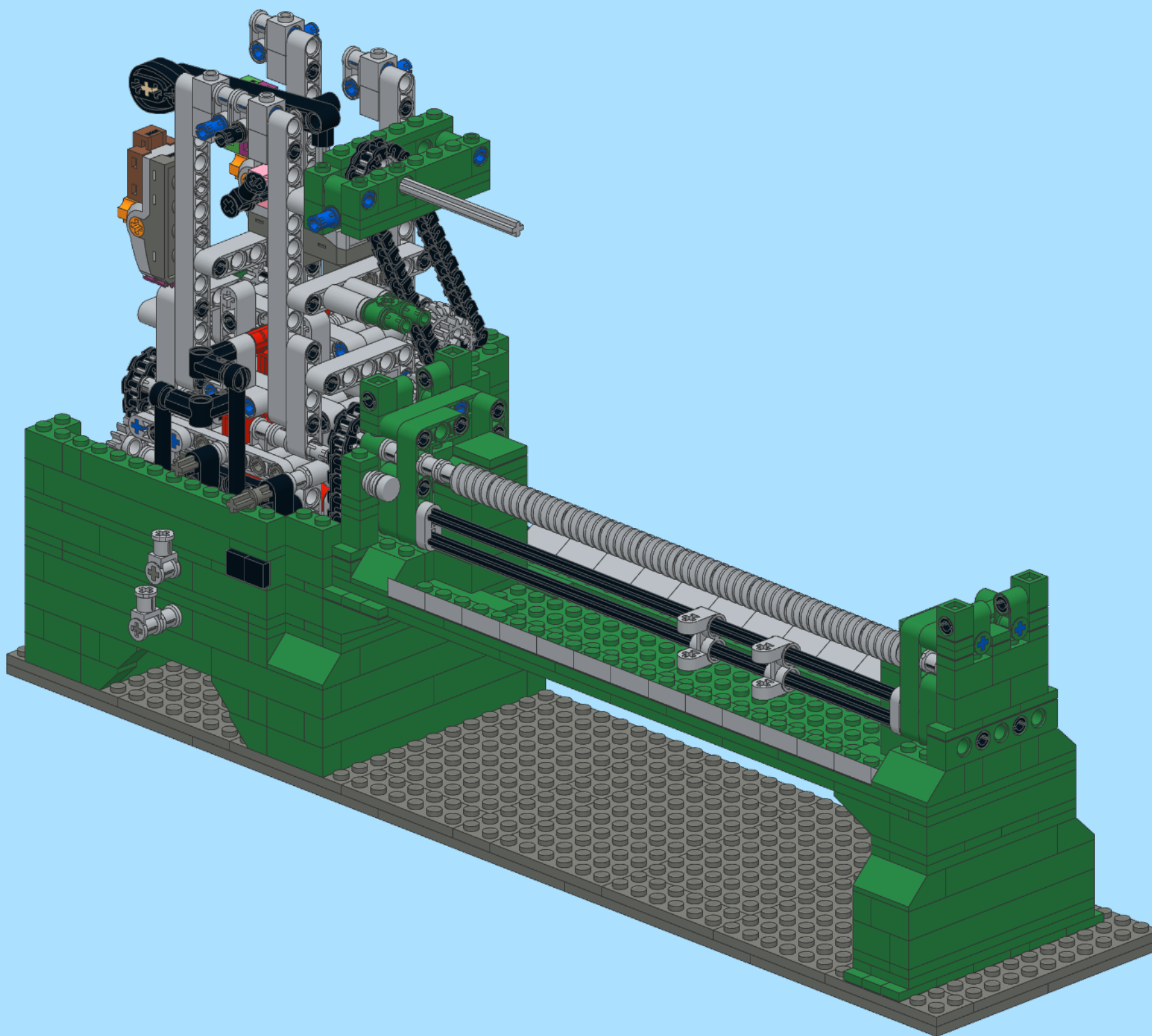
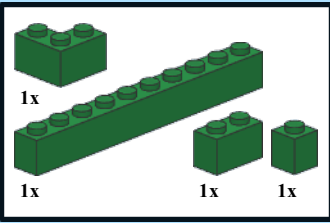



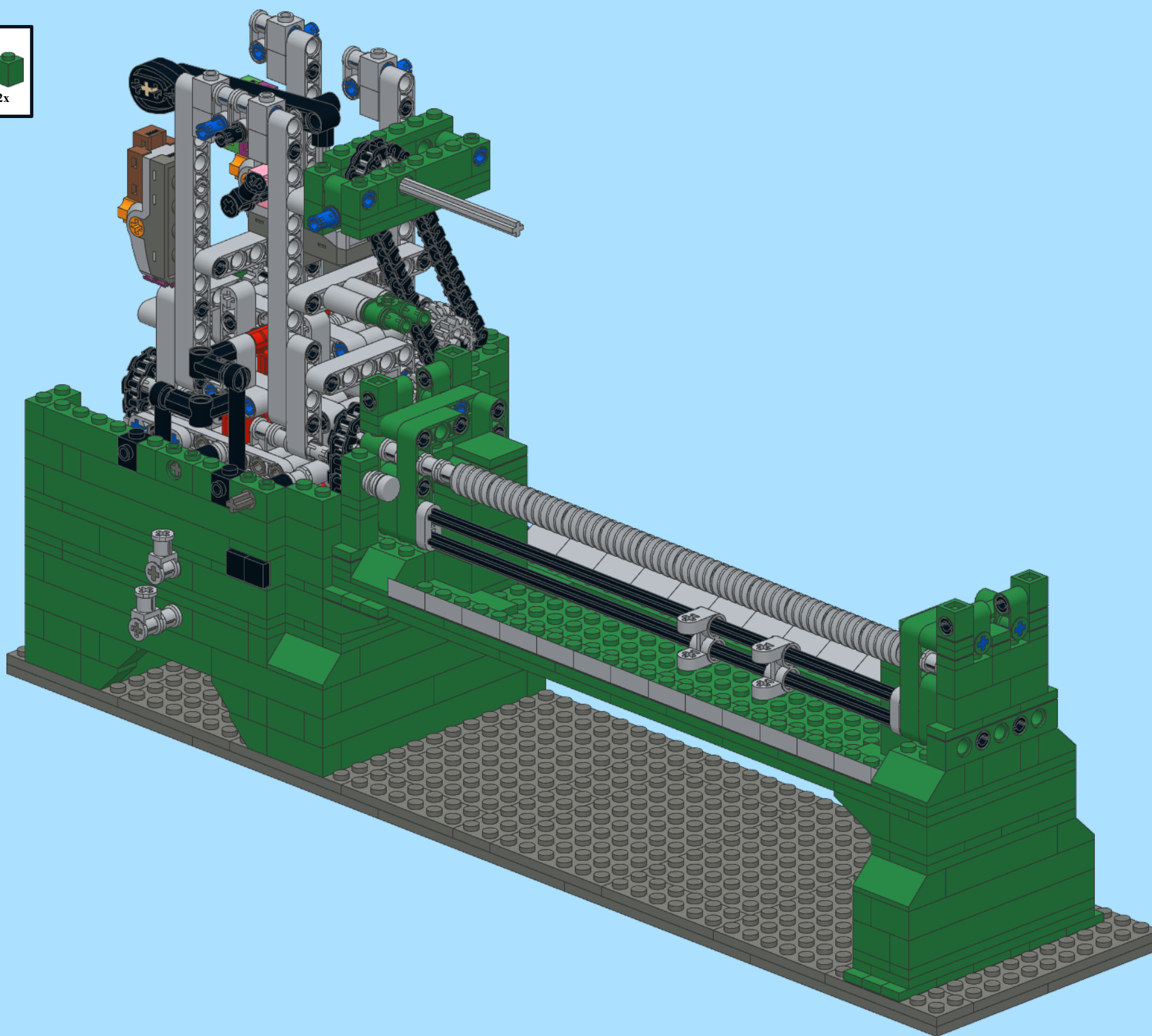
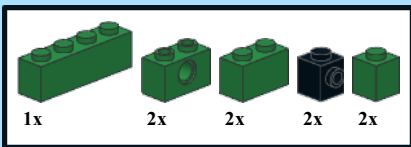

- 2x 2
- 2x
- 1x

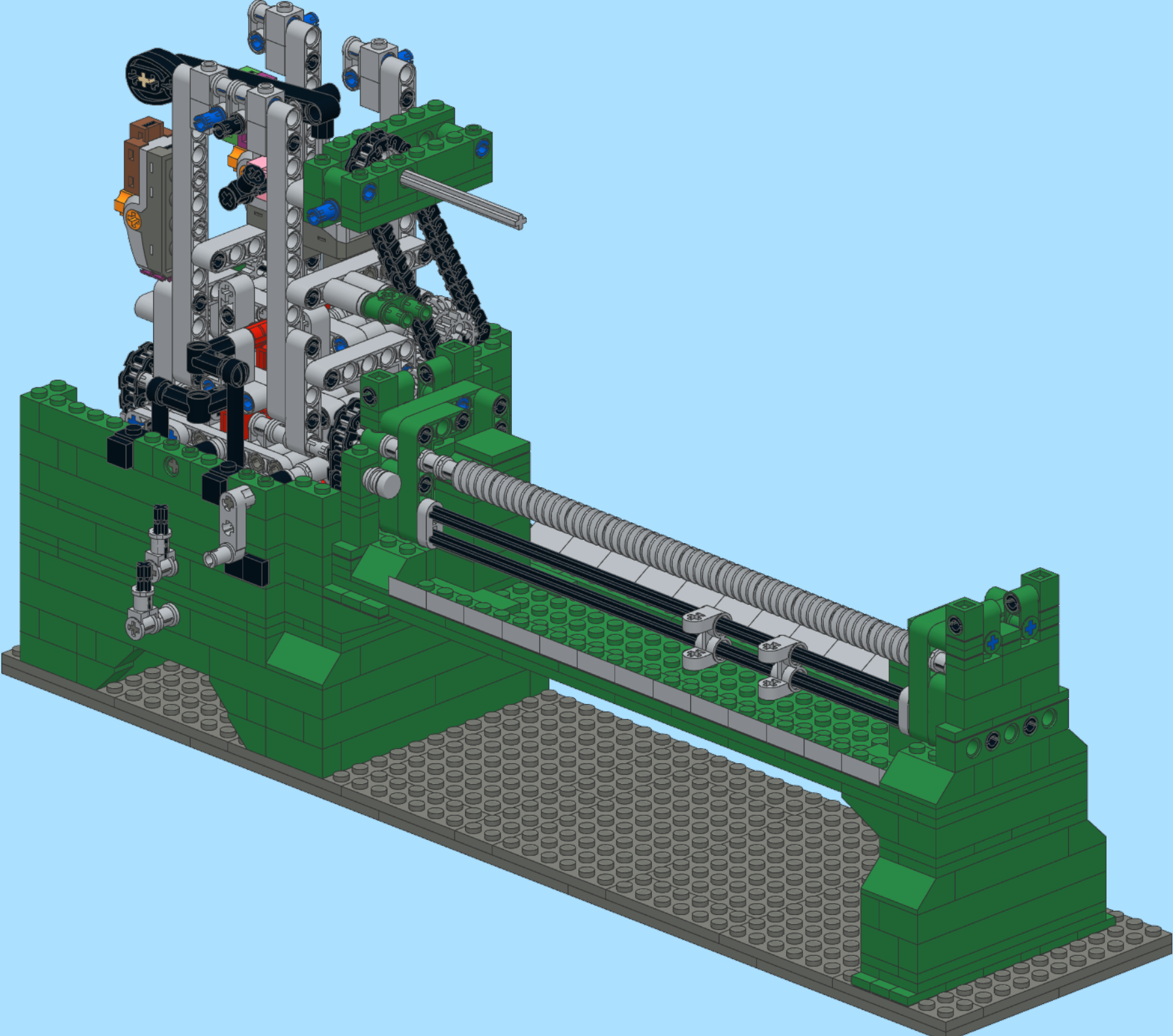

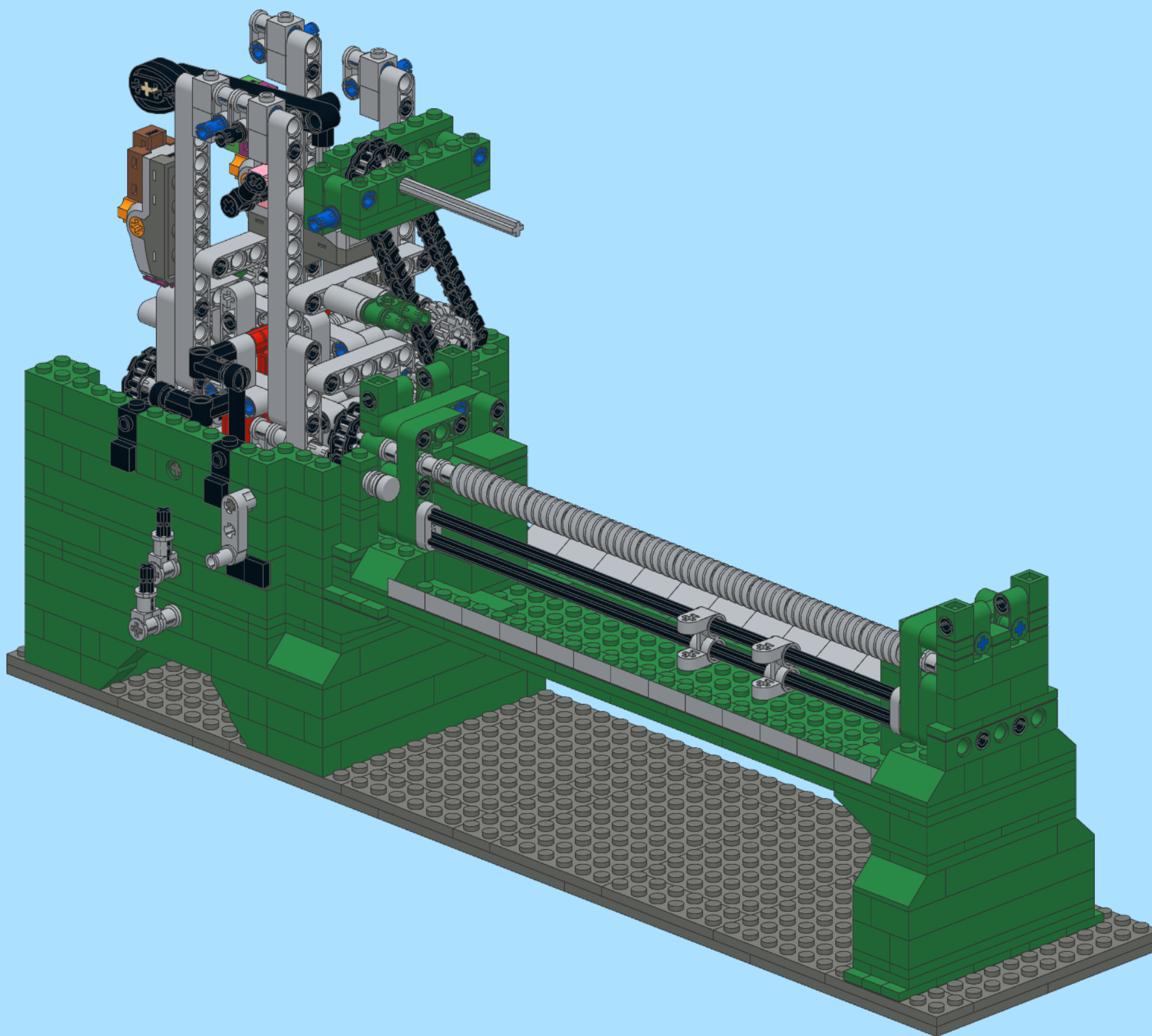
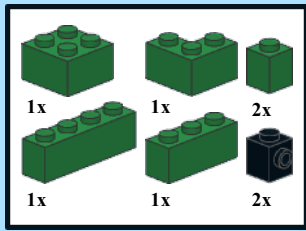

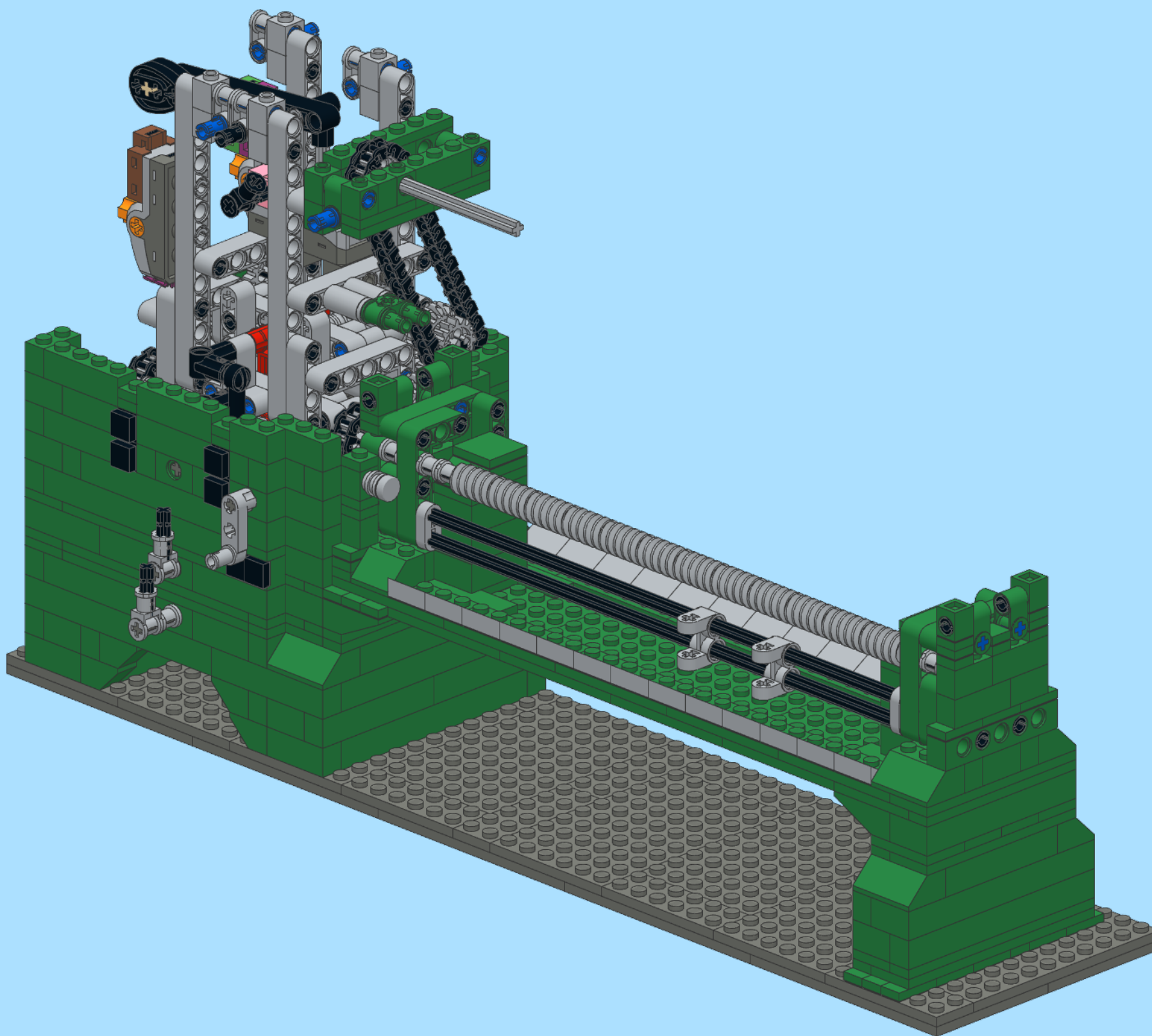
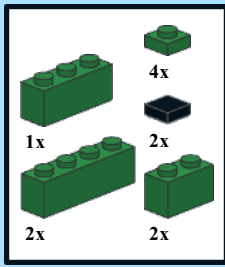

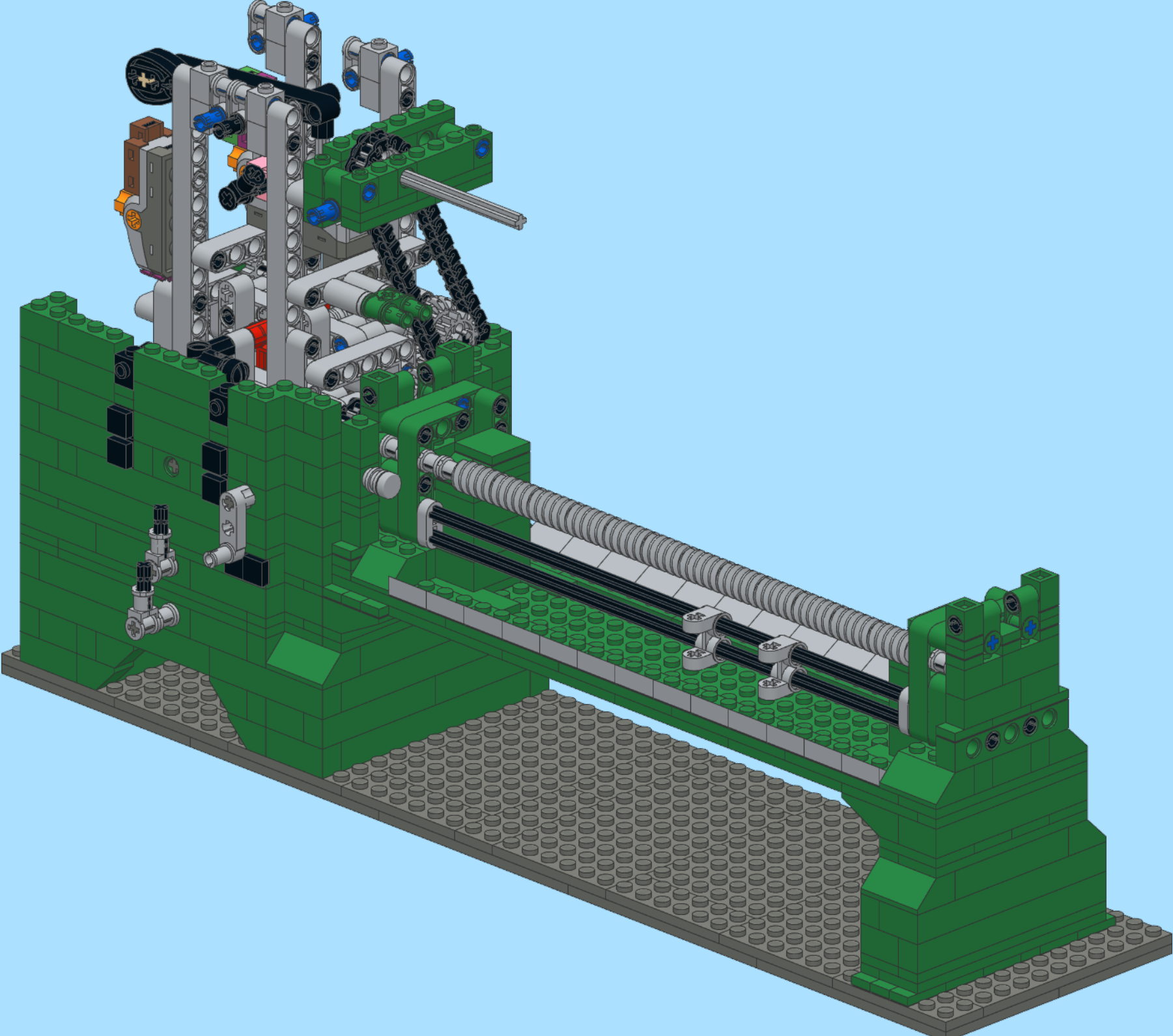
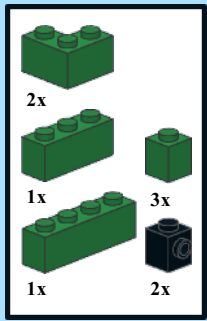

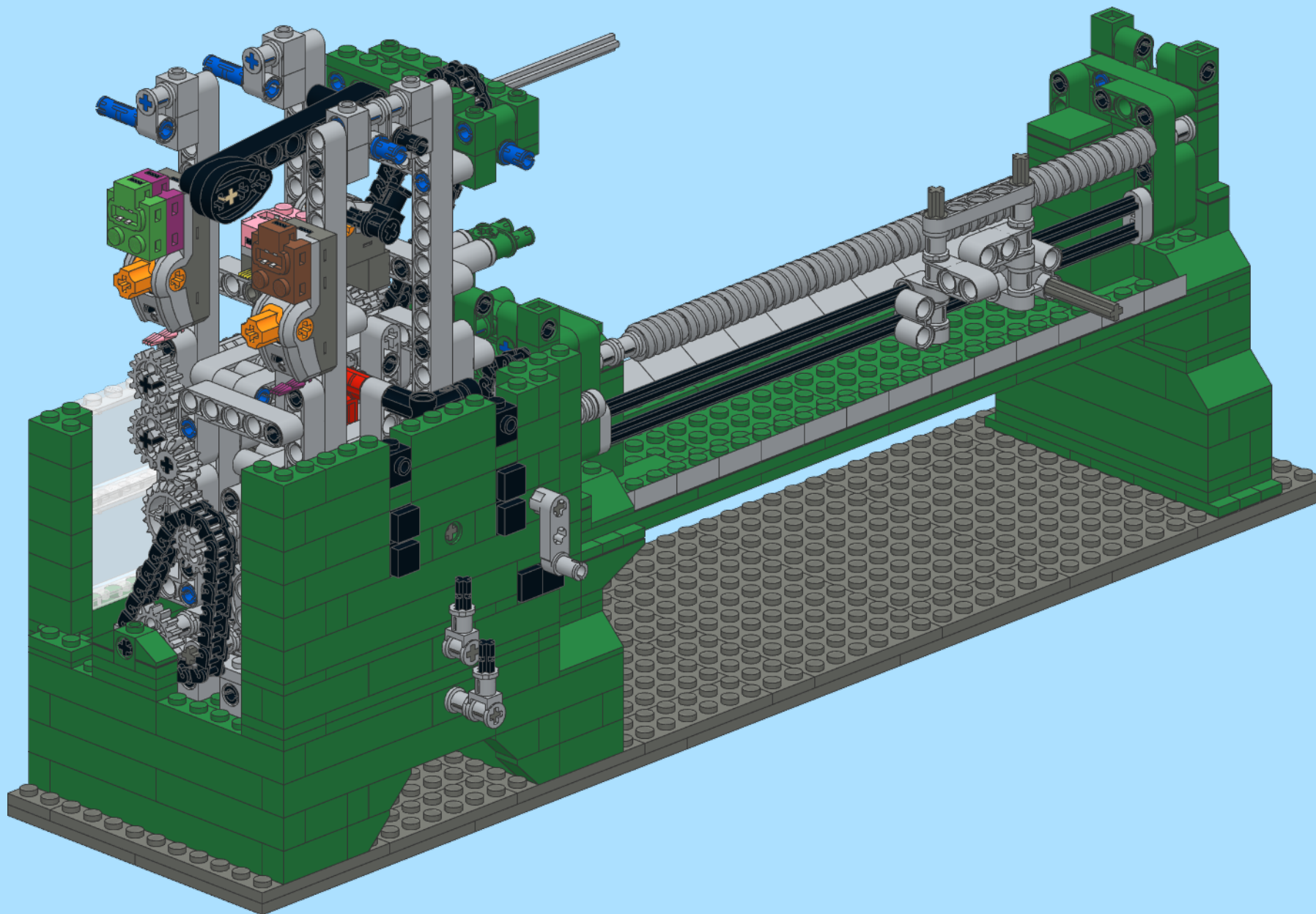
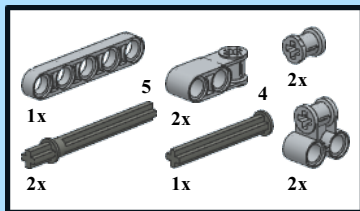

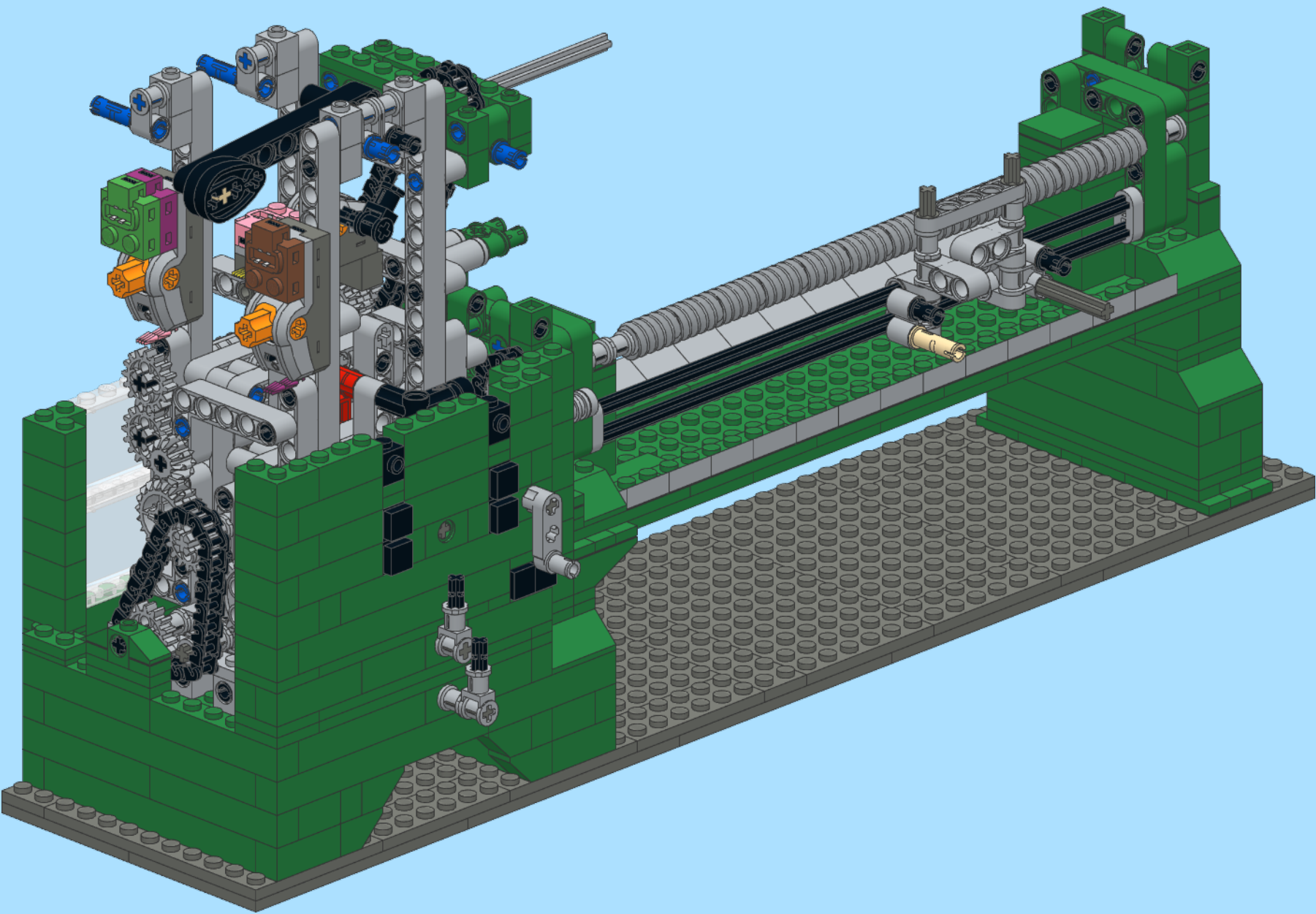

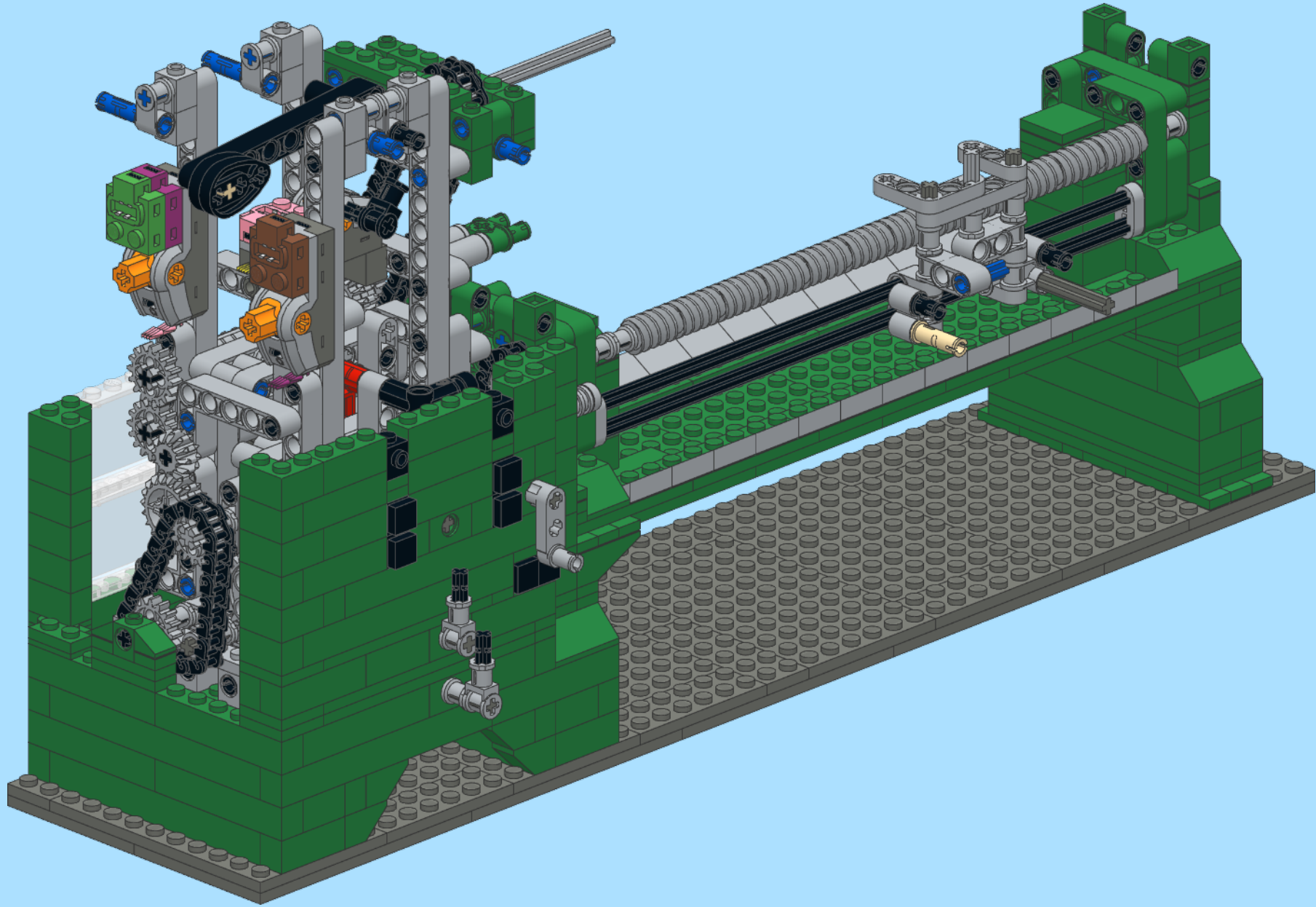
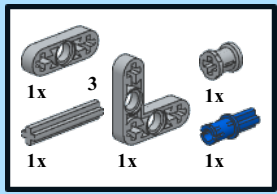



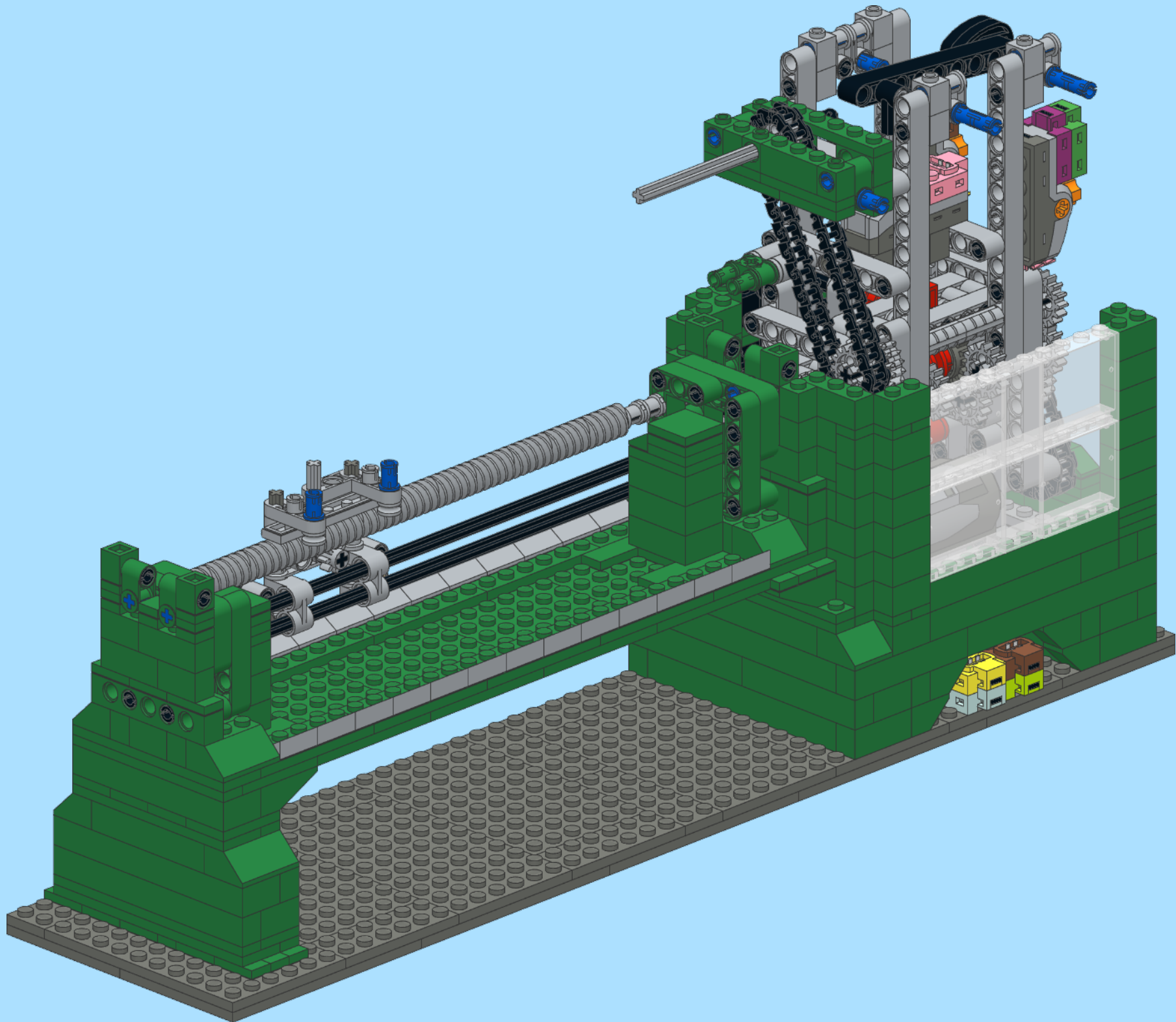
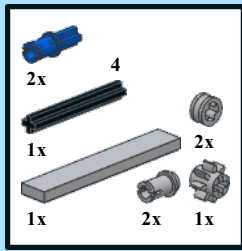

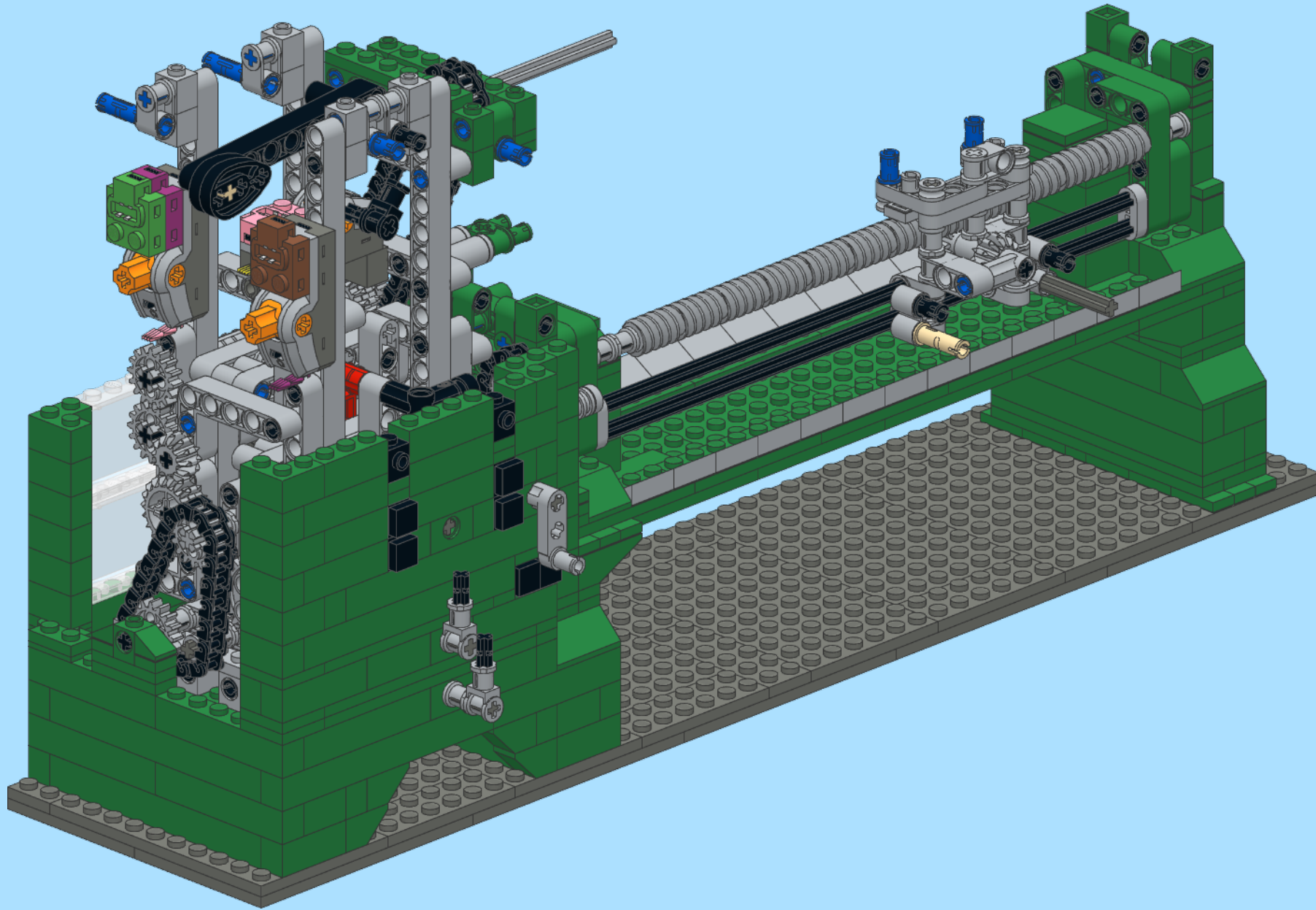
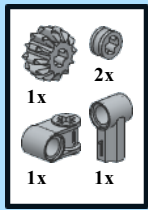

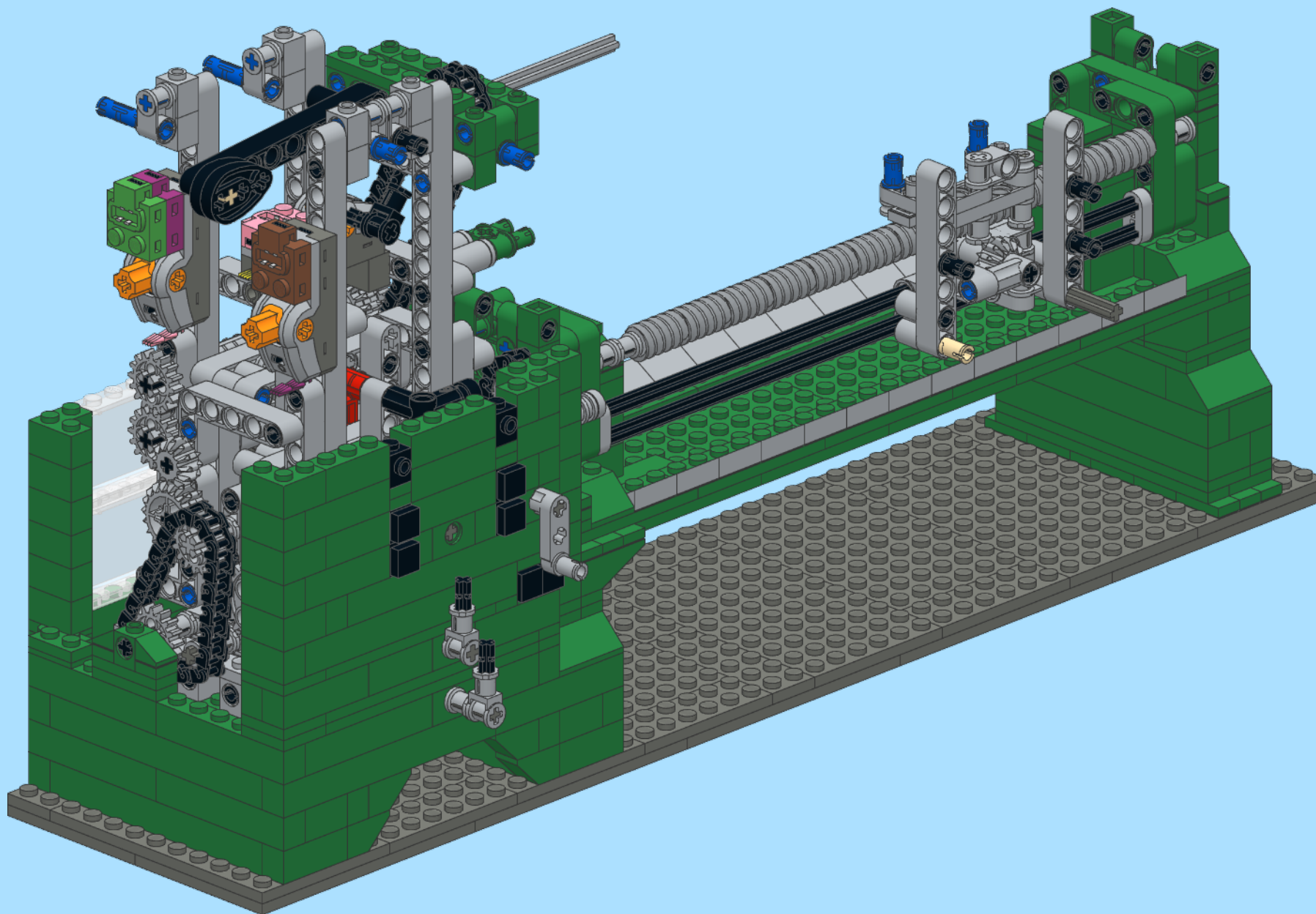
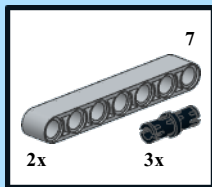

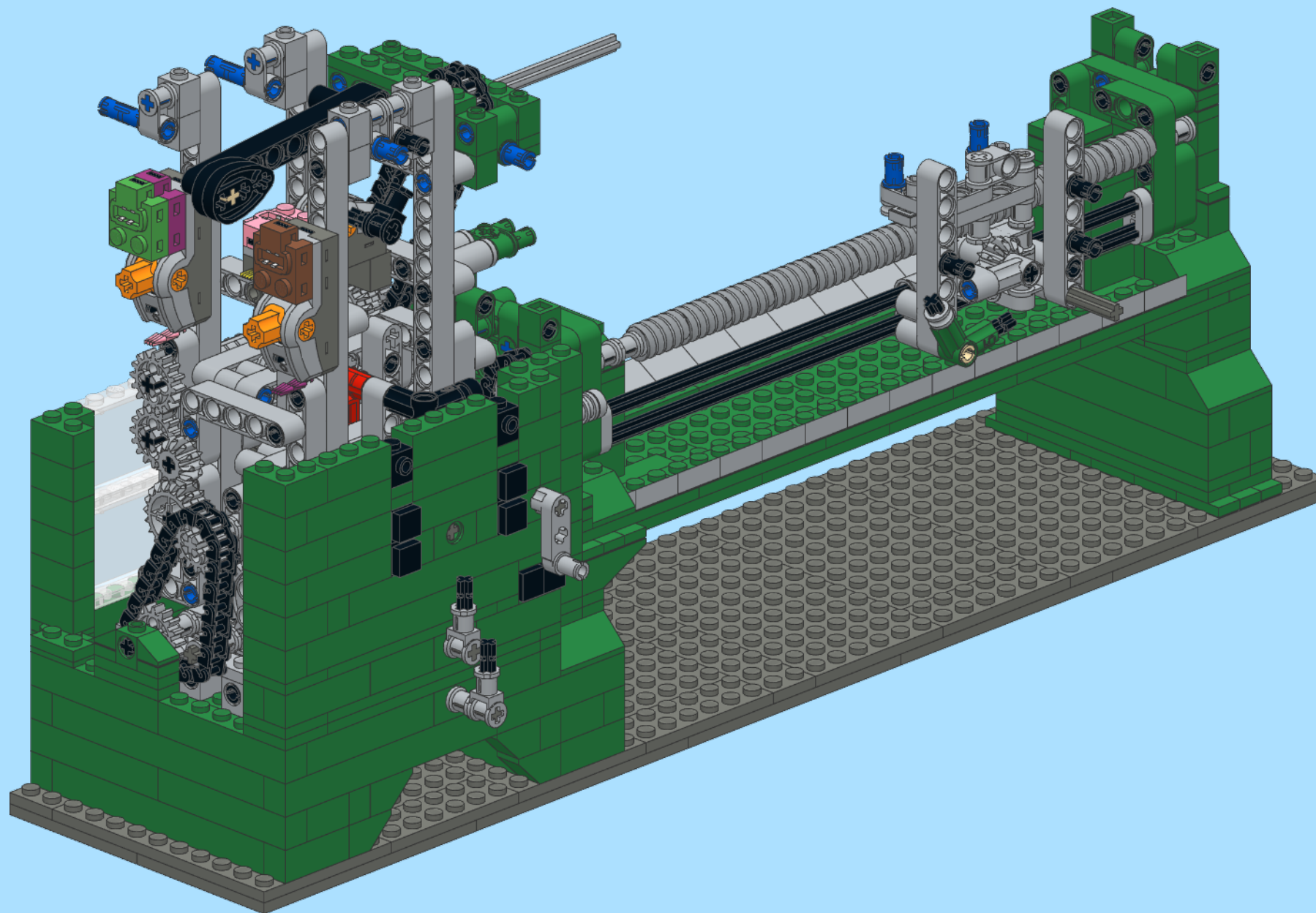
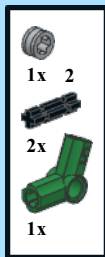

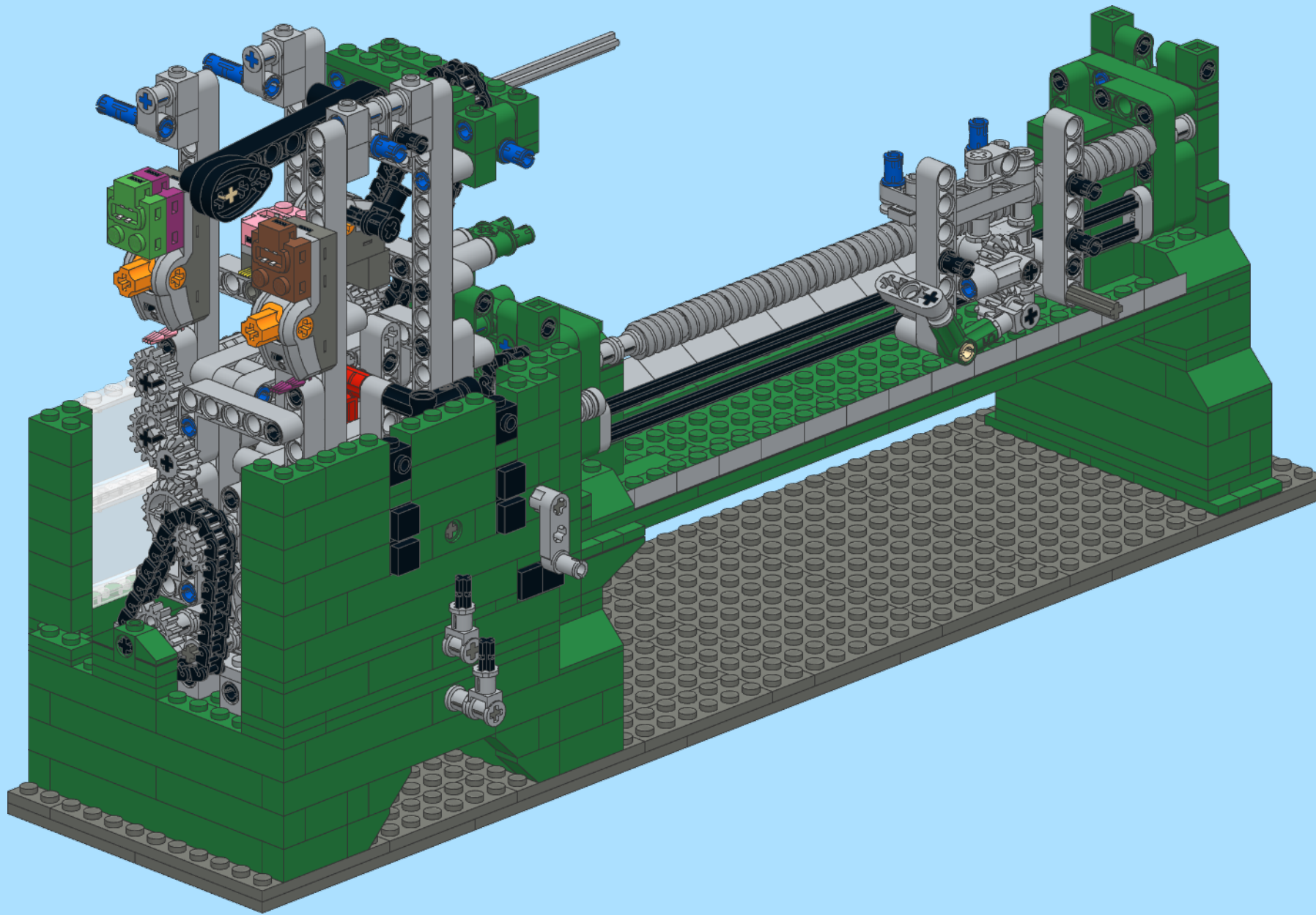
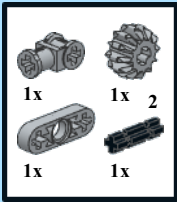

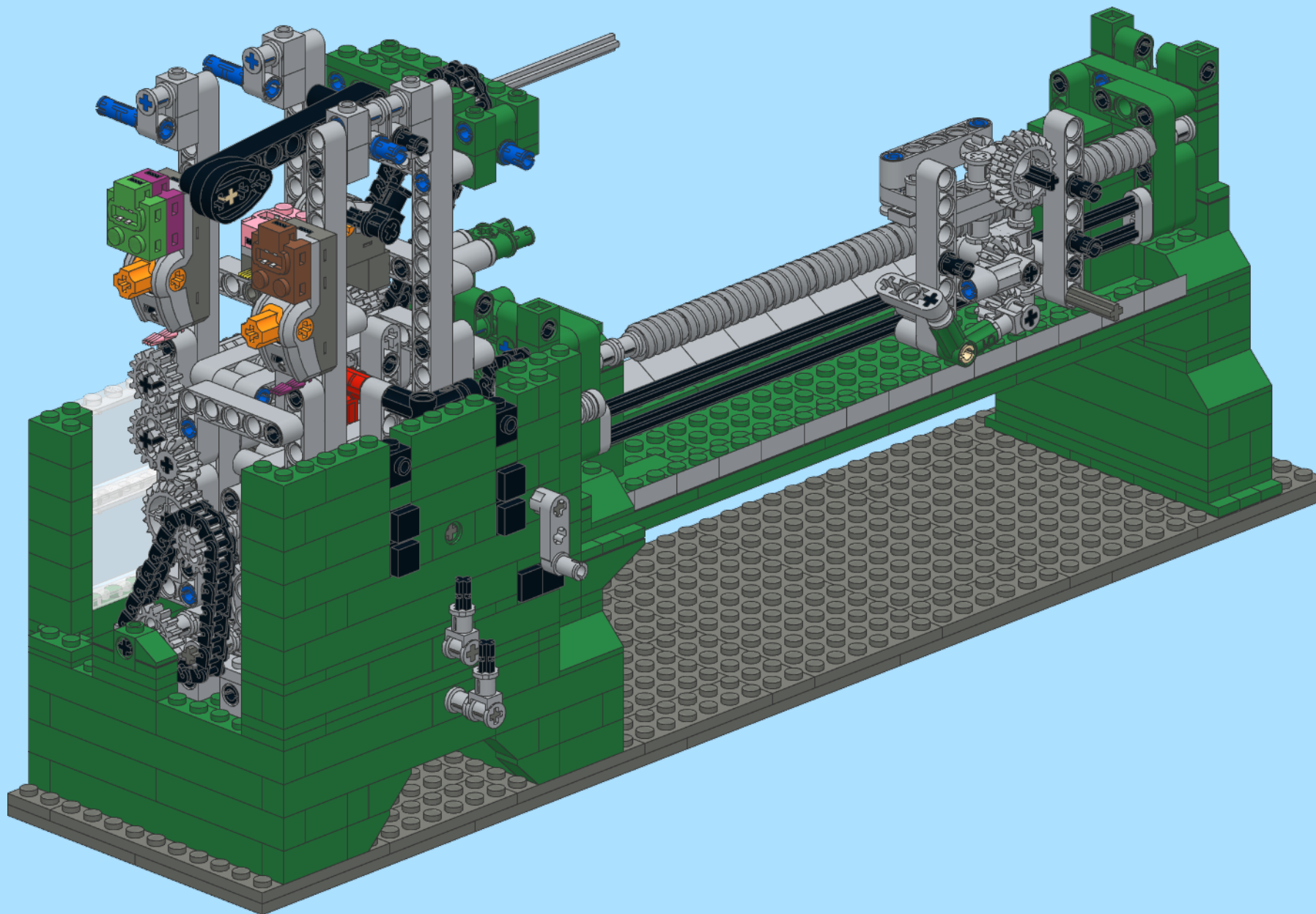
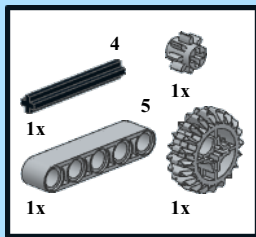





-  2x
-  1x 2
-  1x

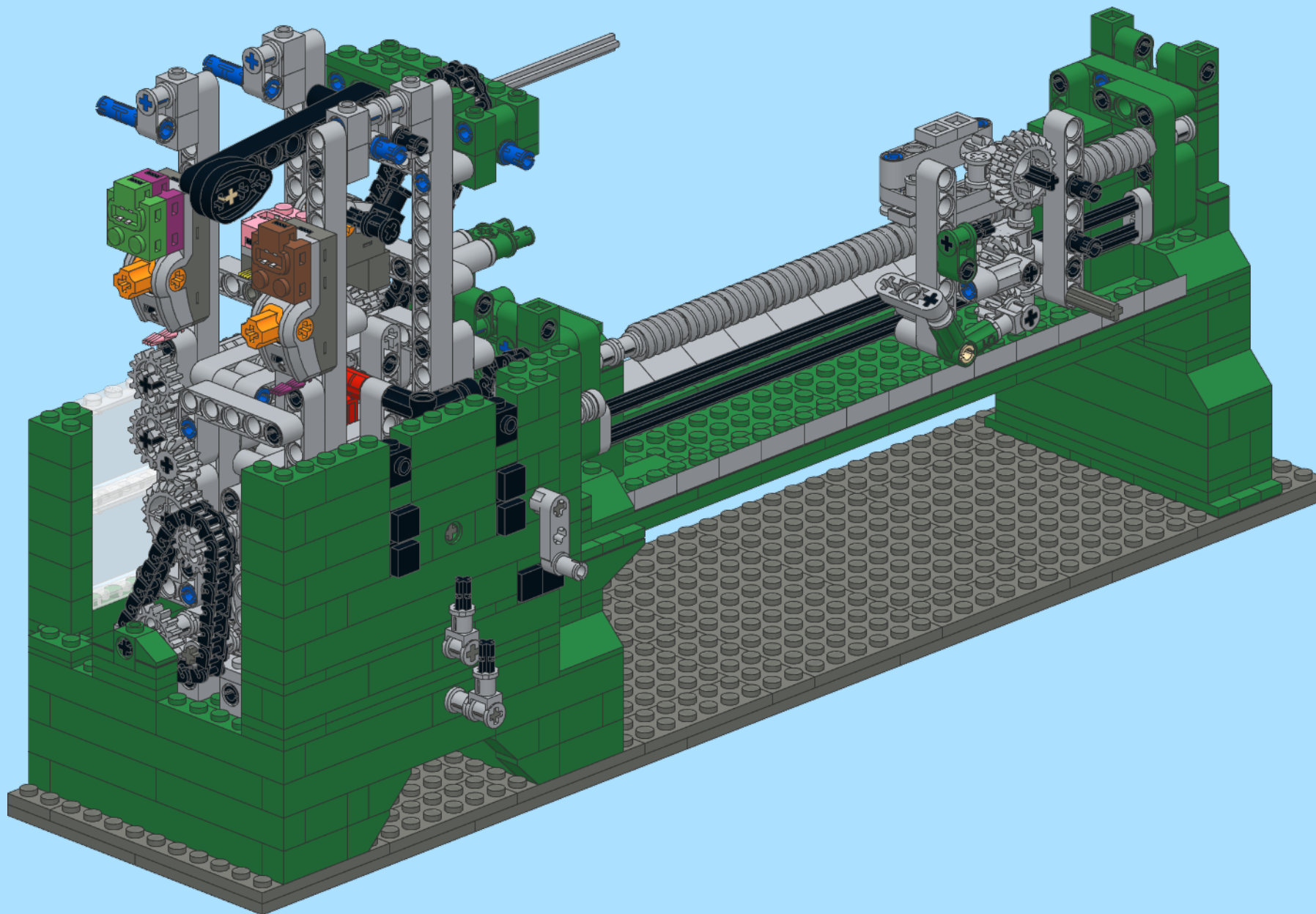

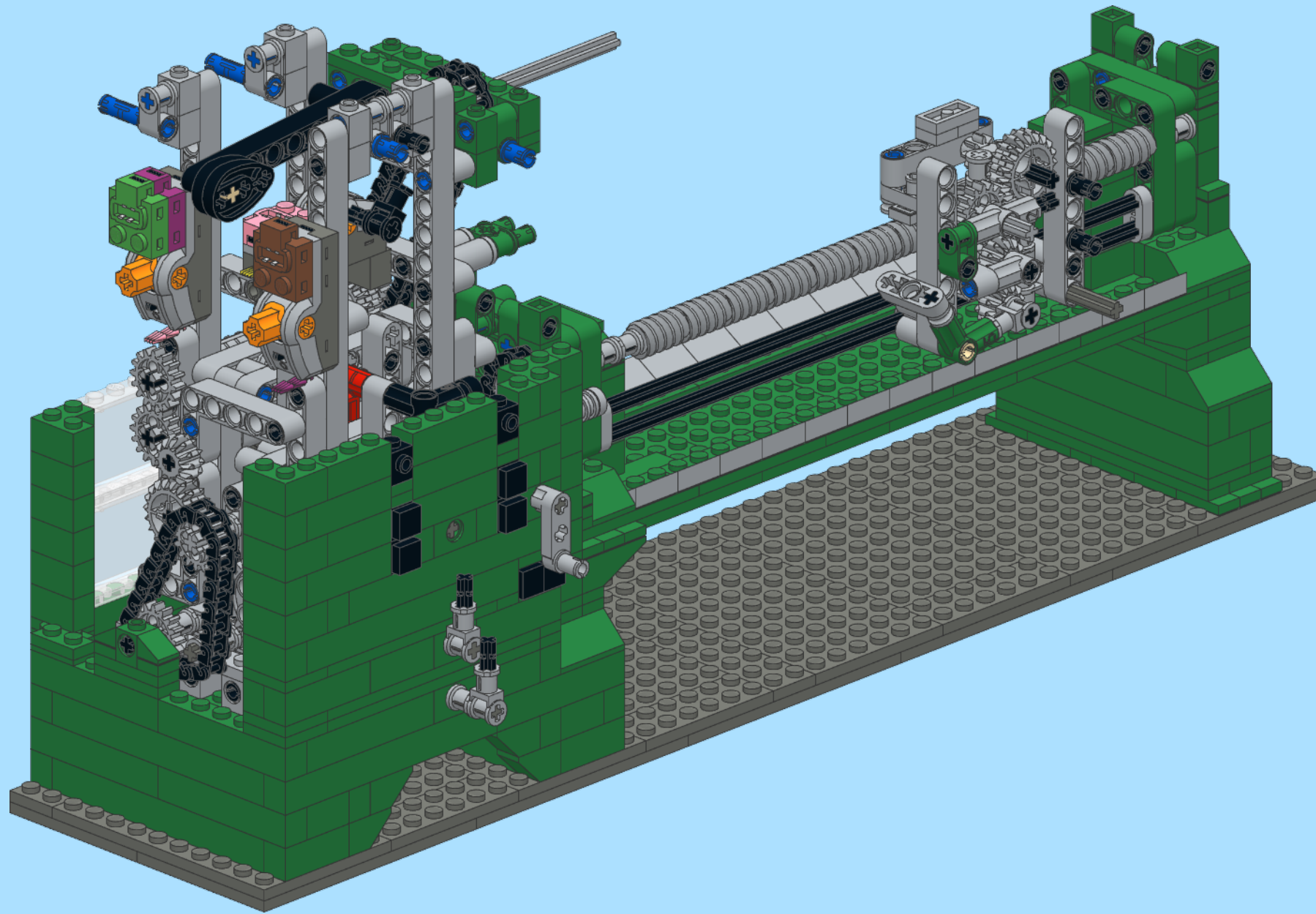
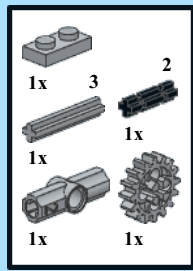



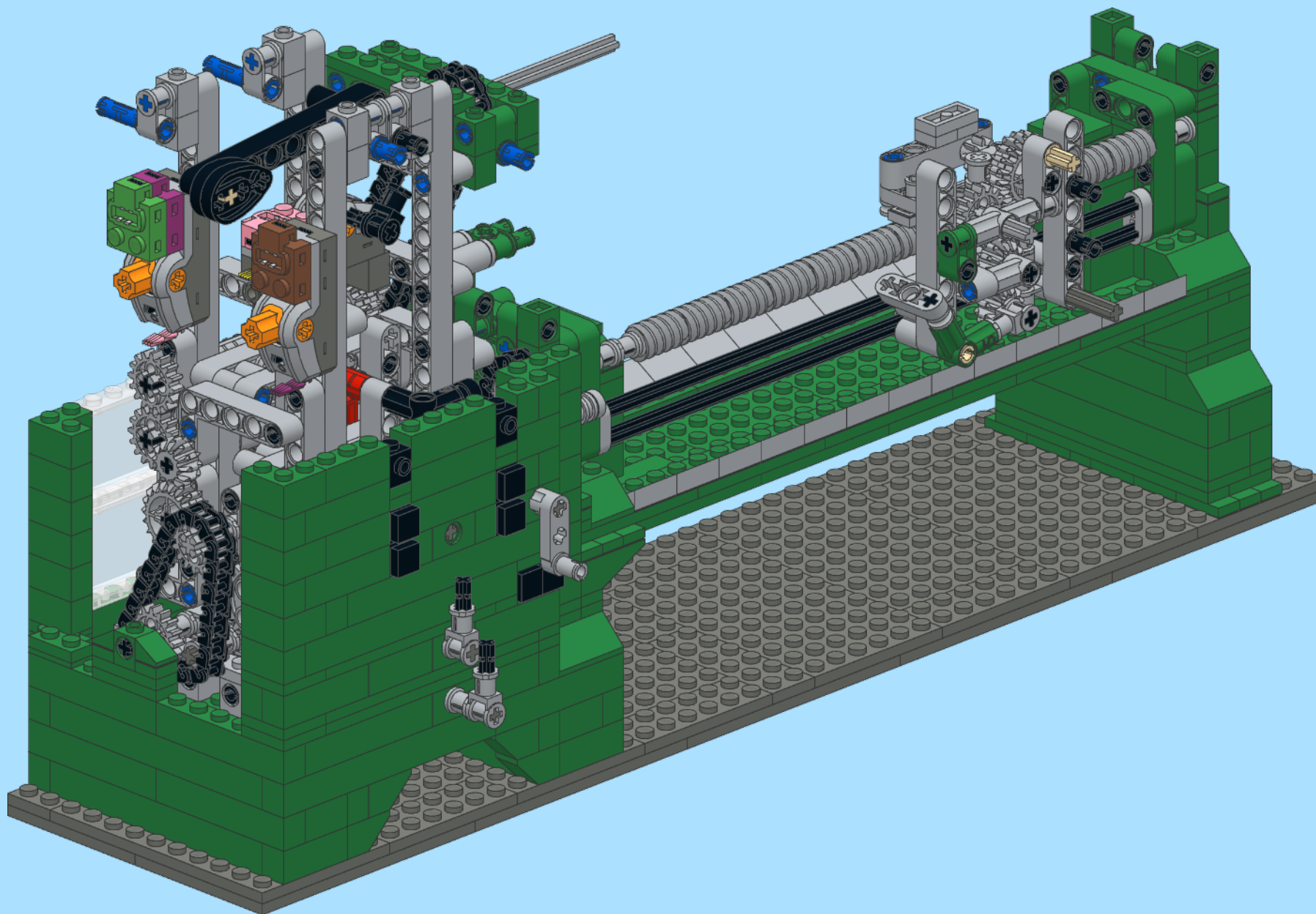
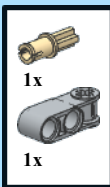

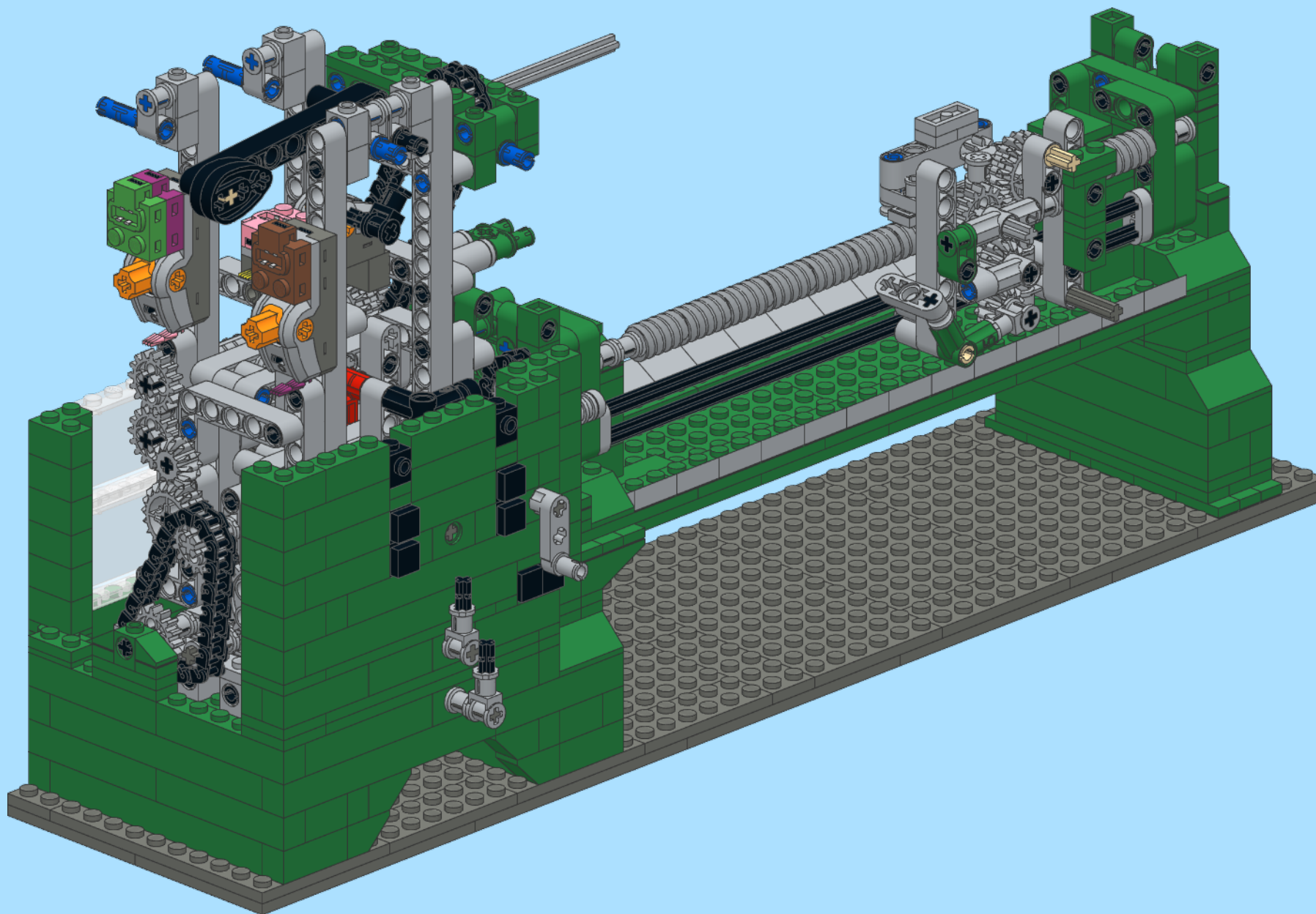
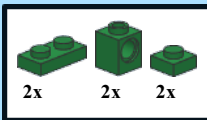

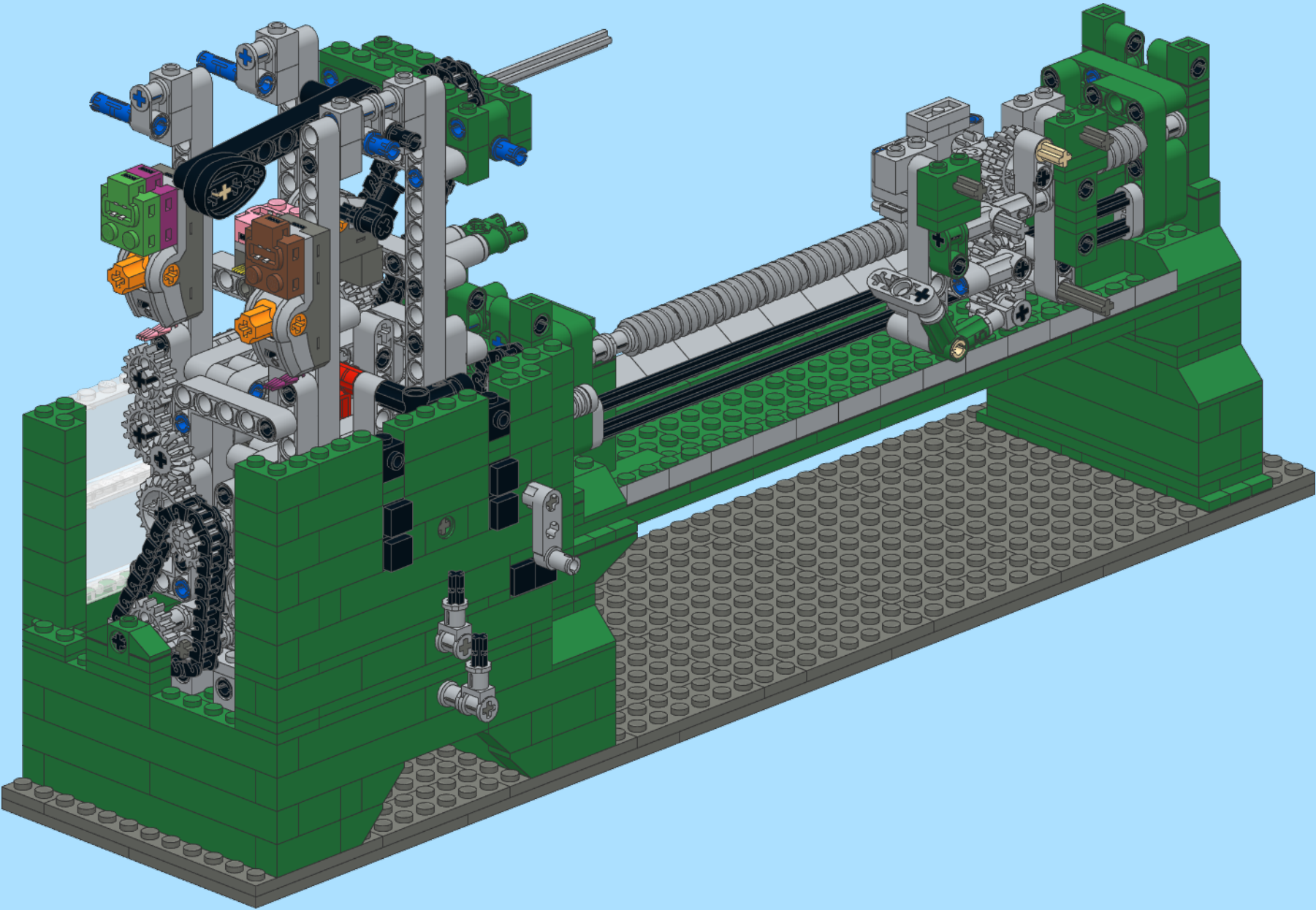
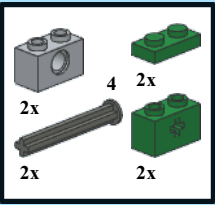

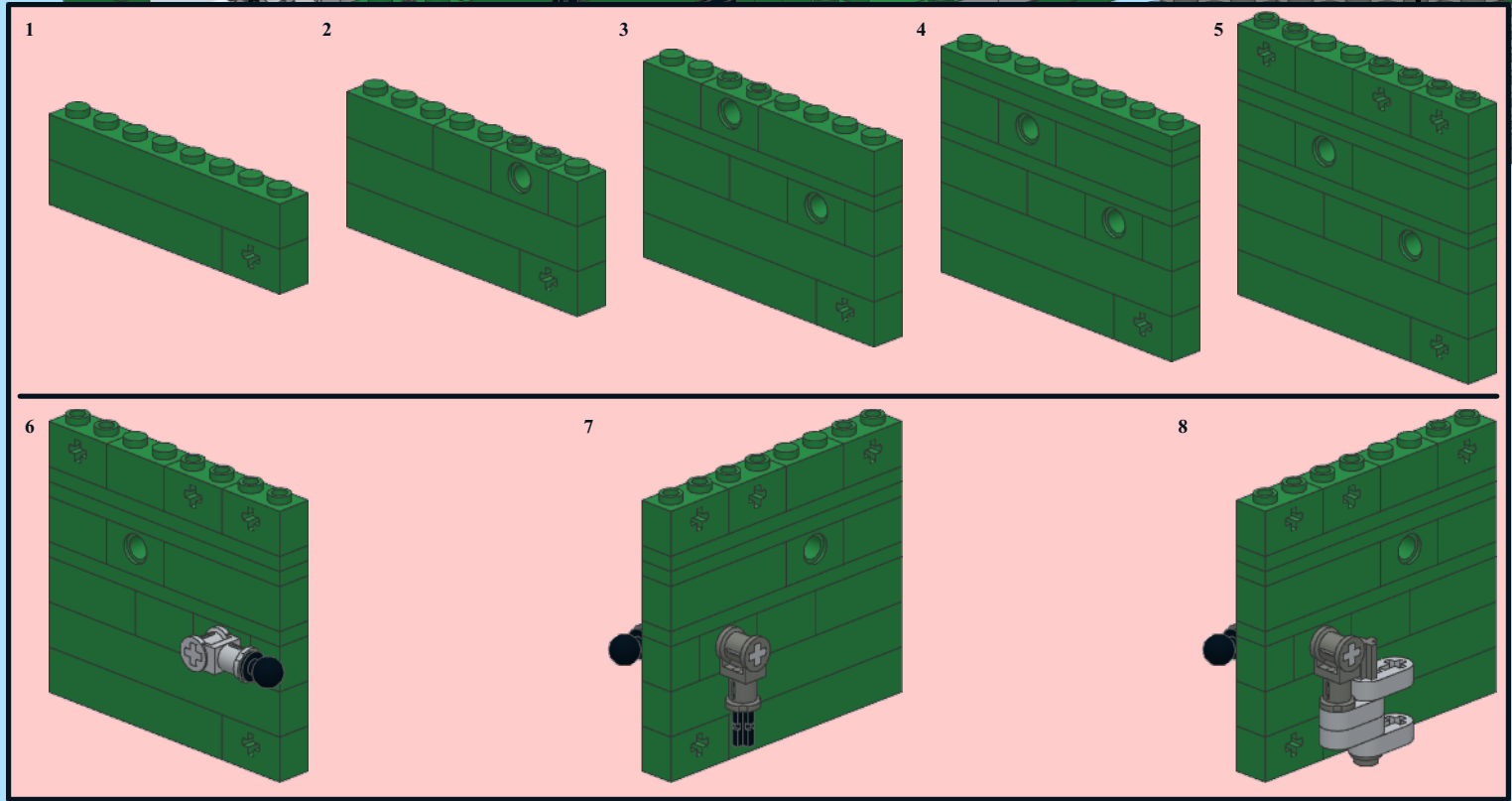
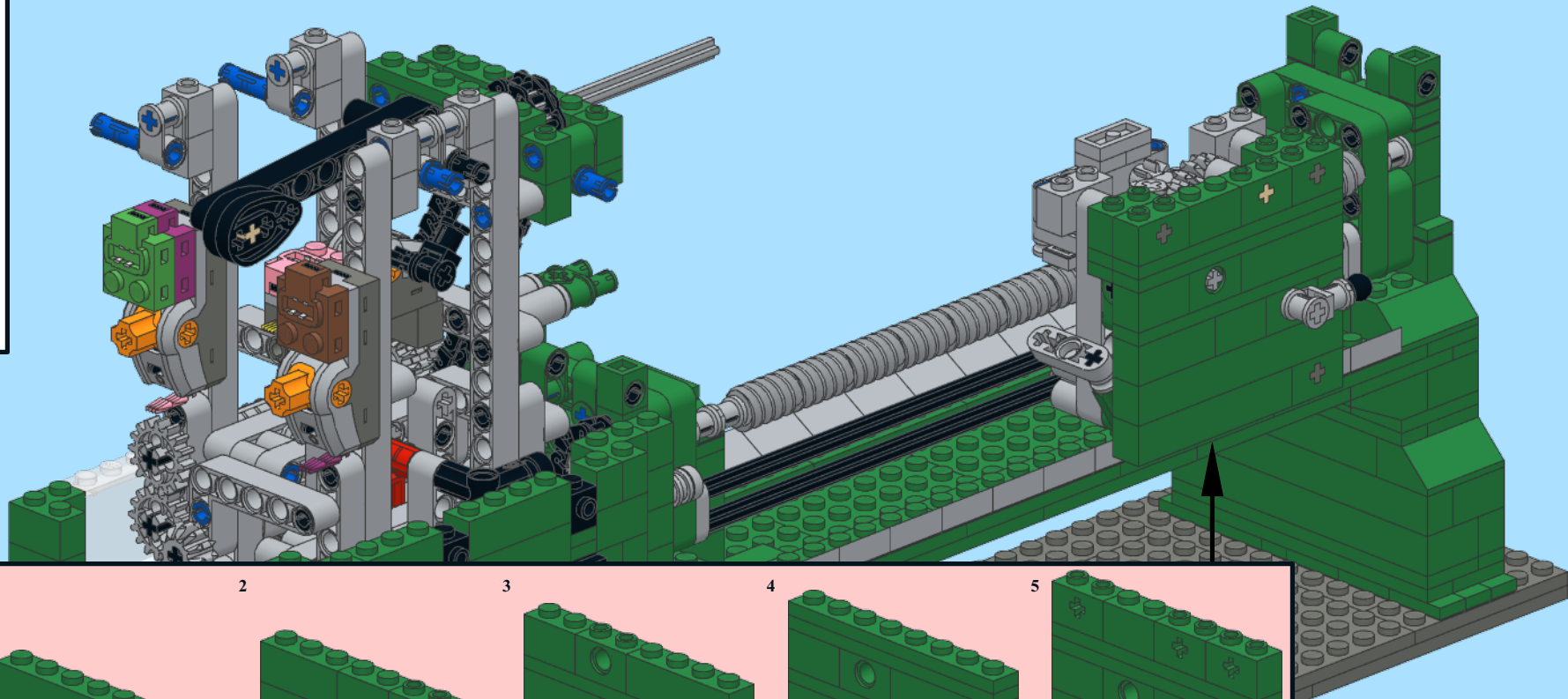
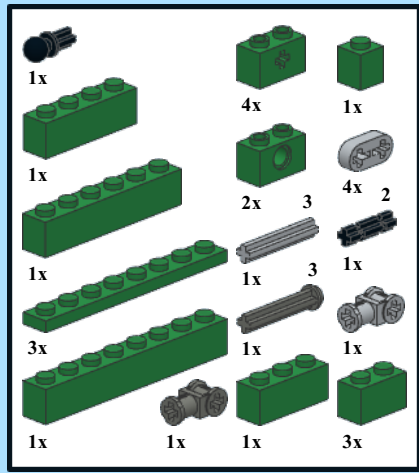

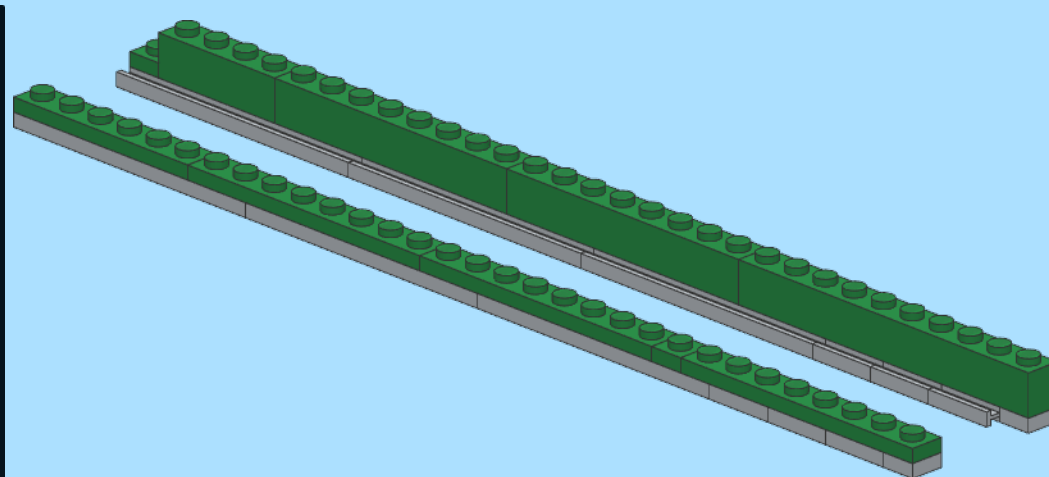
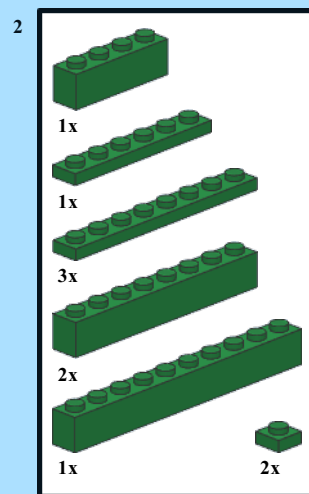
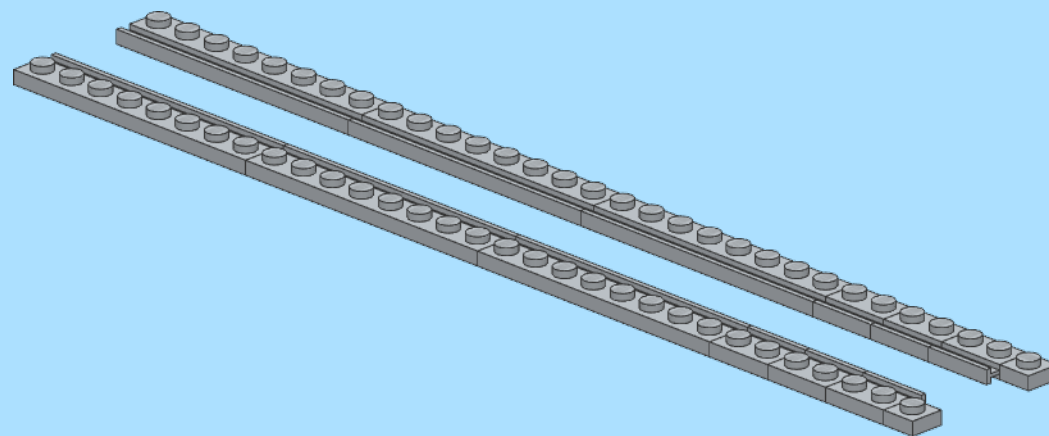
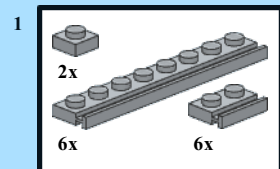

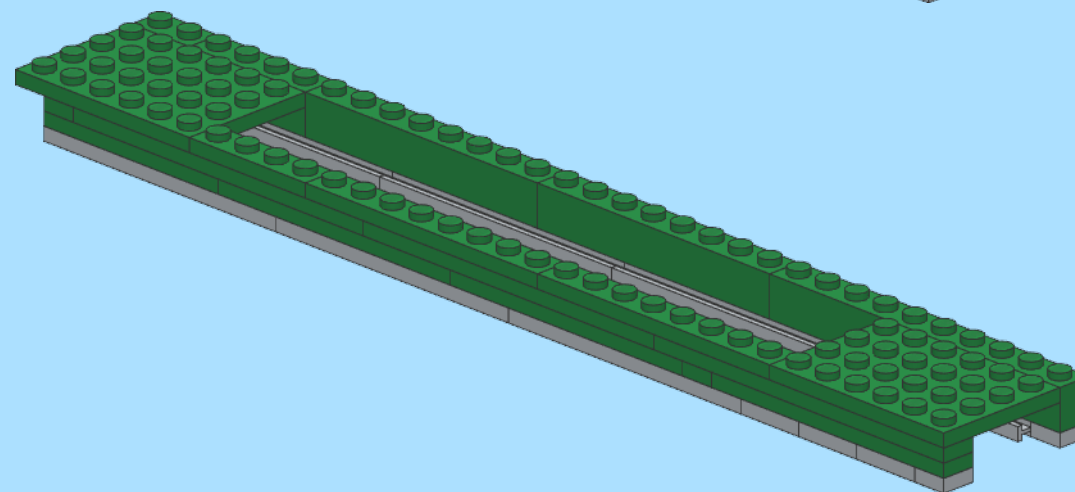
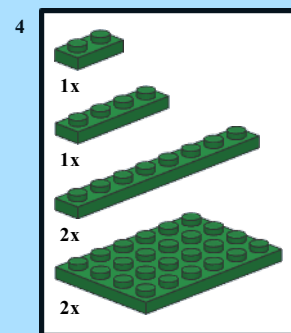
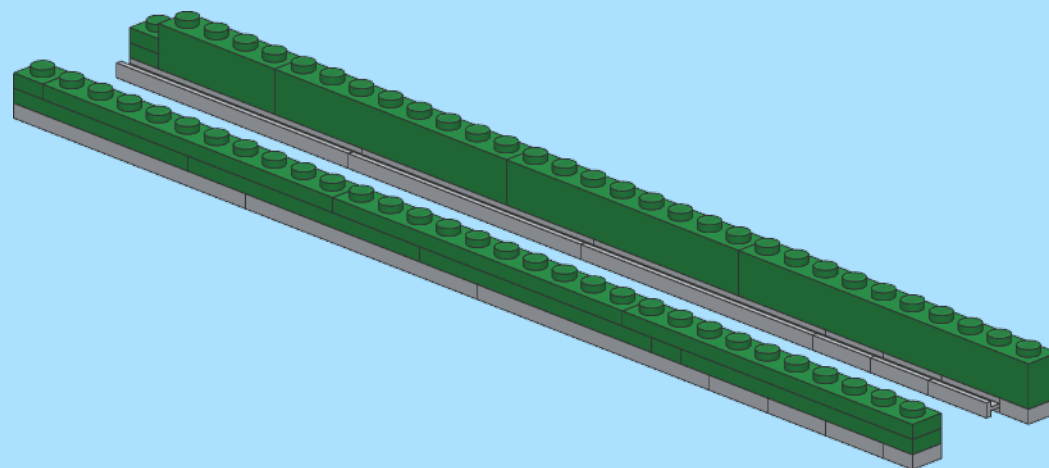
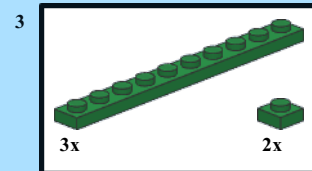

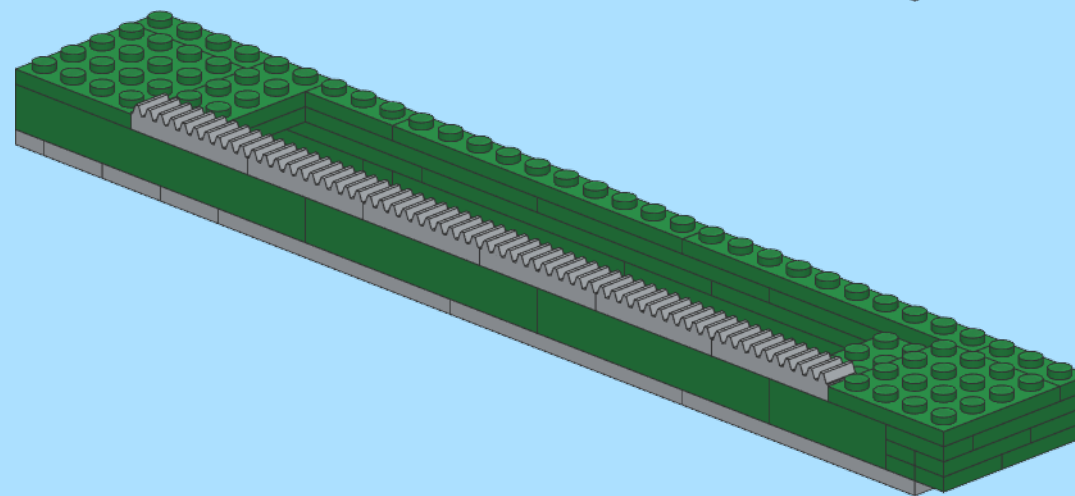
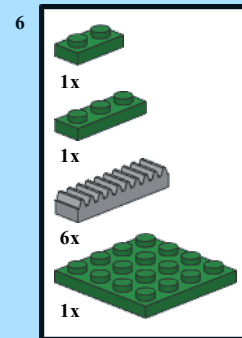
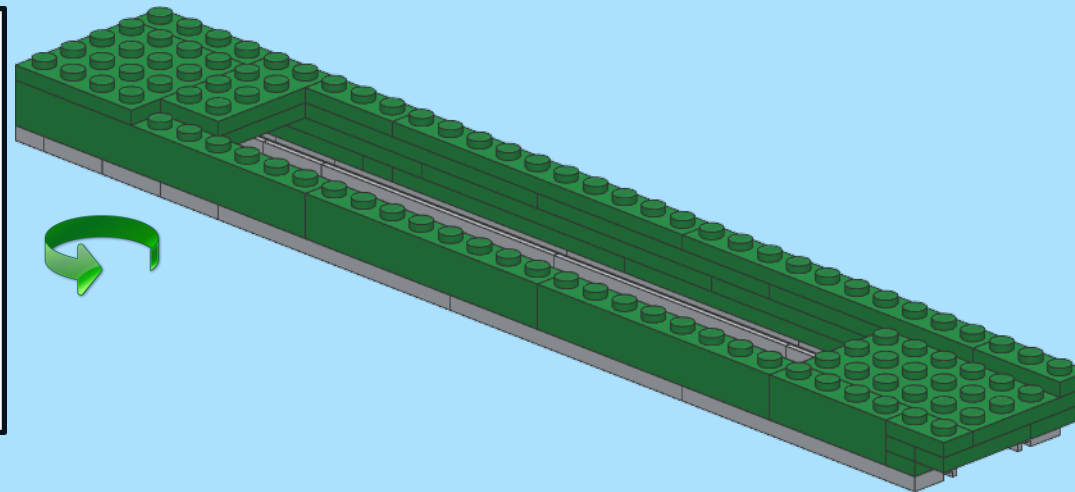
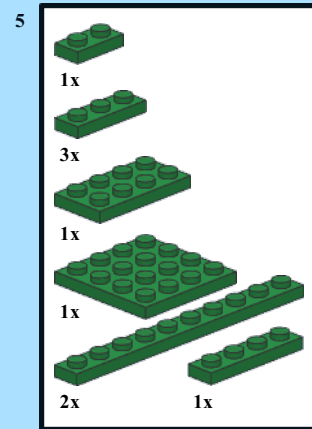

7

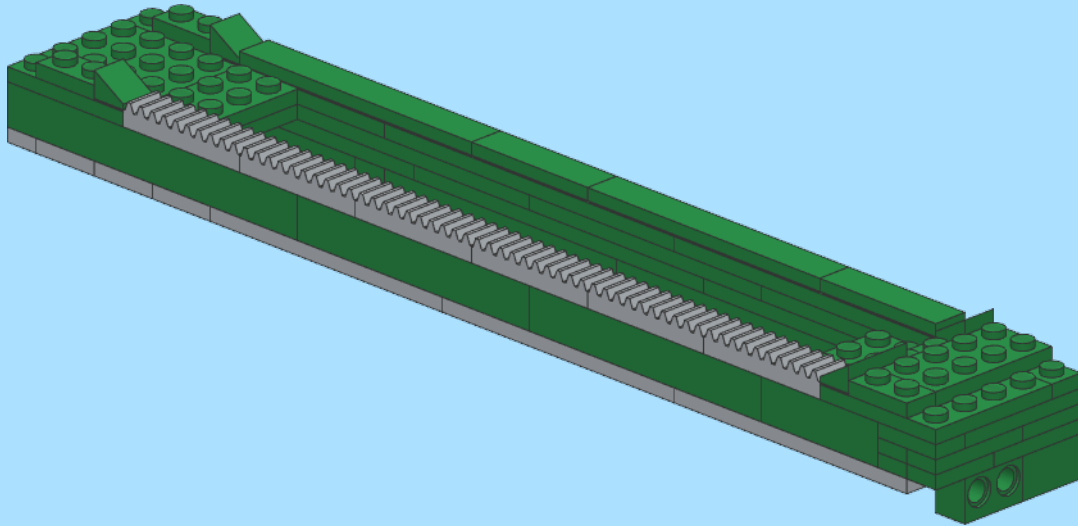
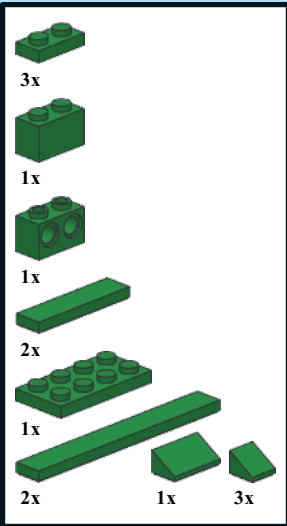

8

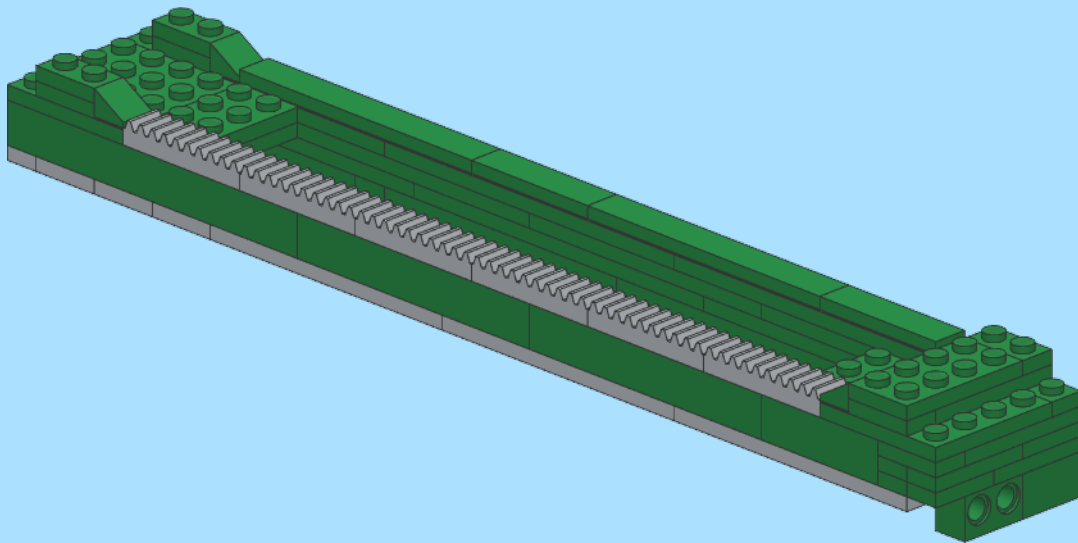
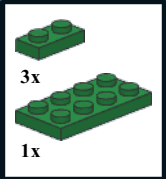



9

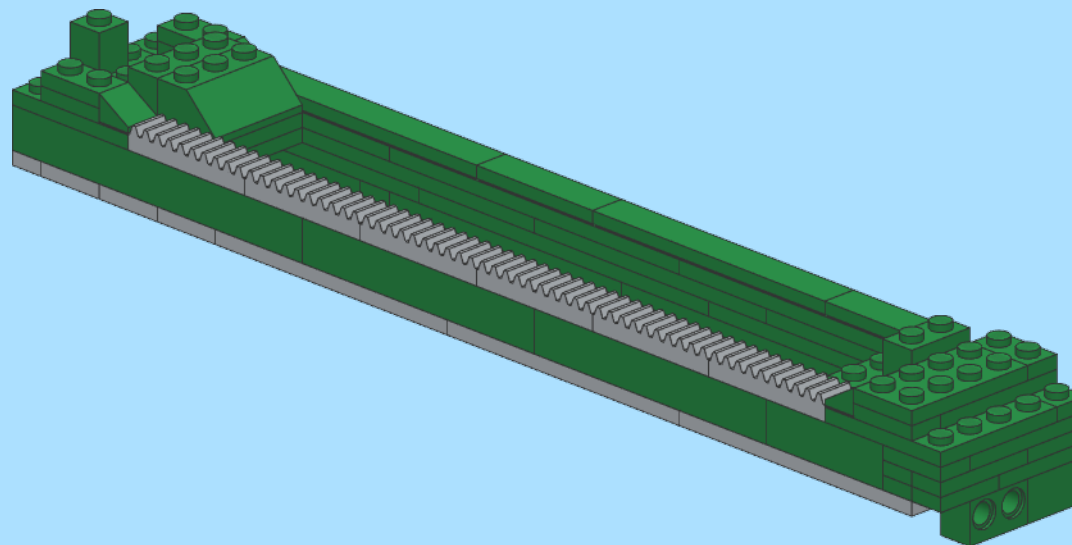
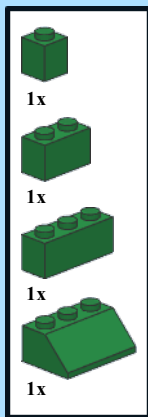

10

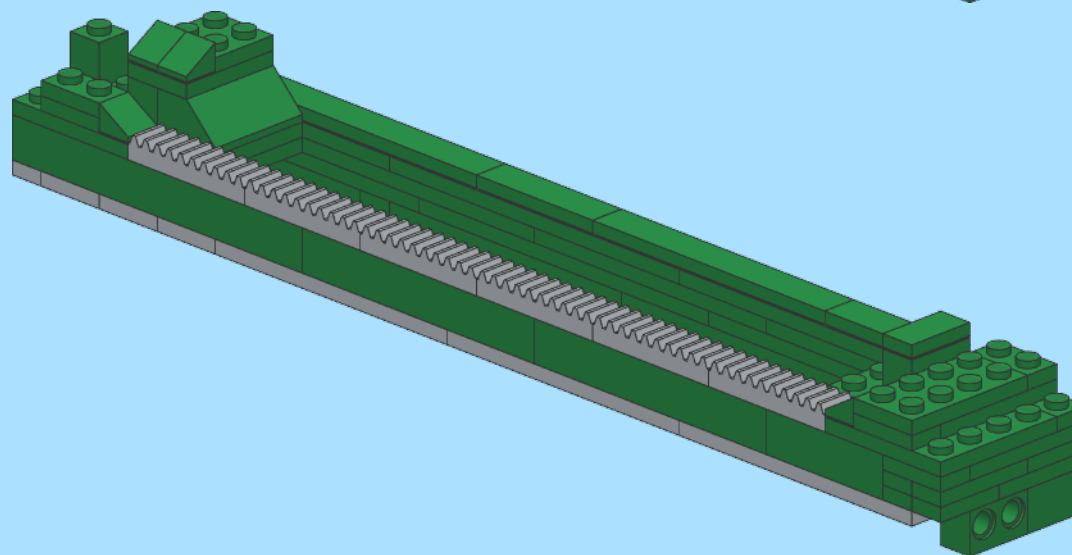
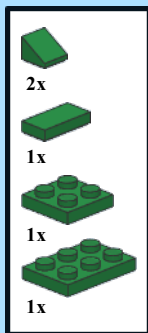

11

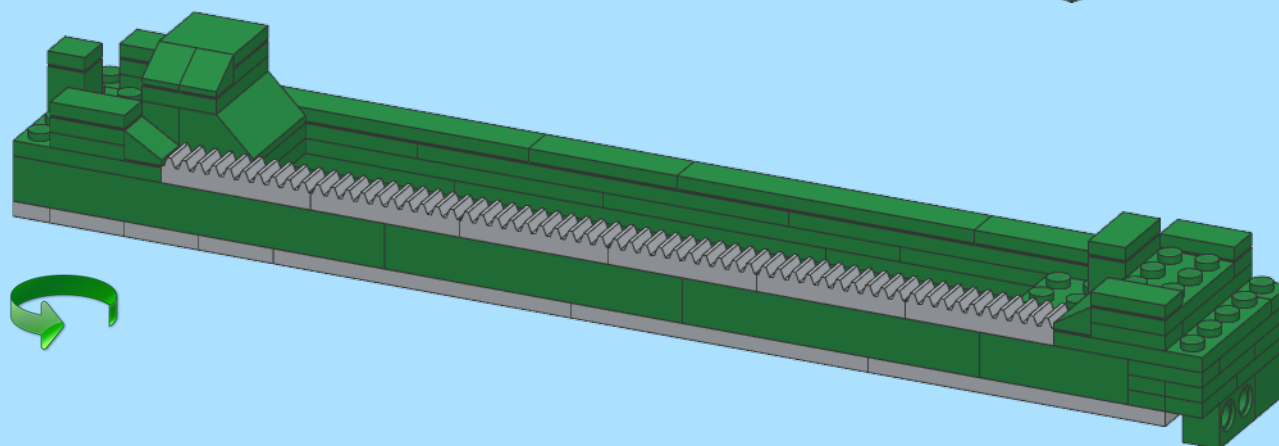
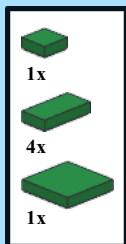

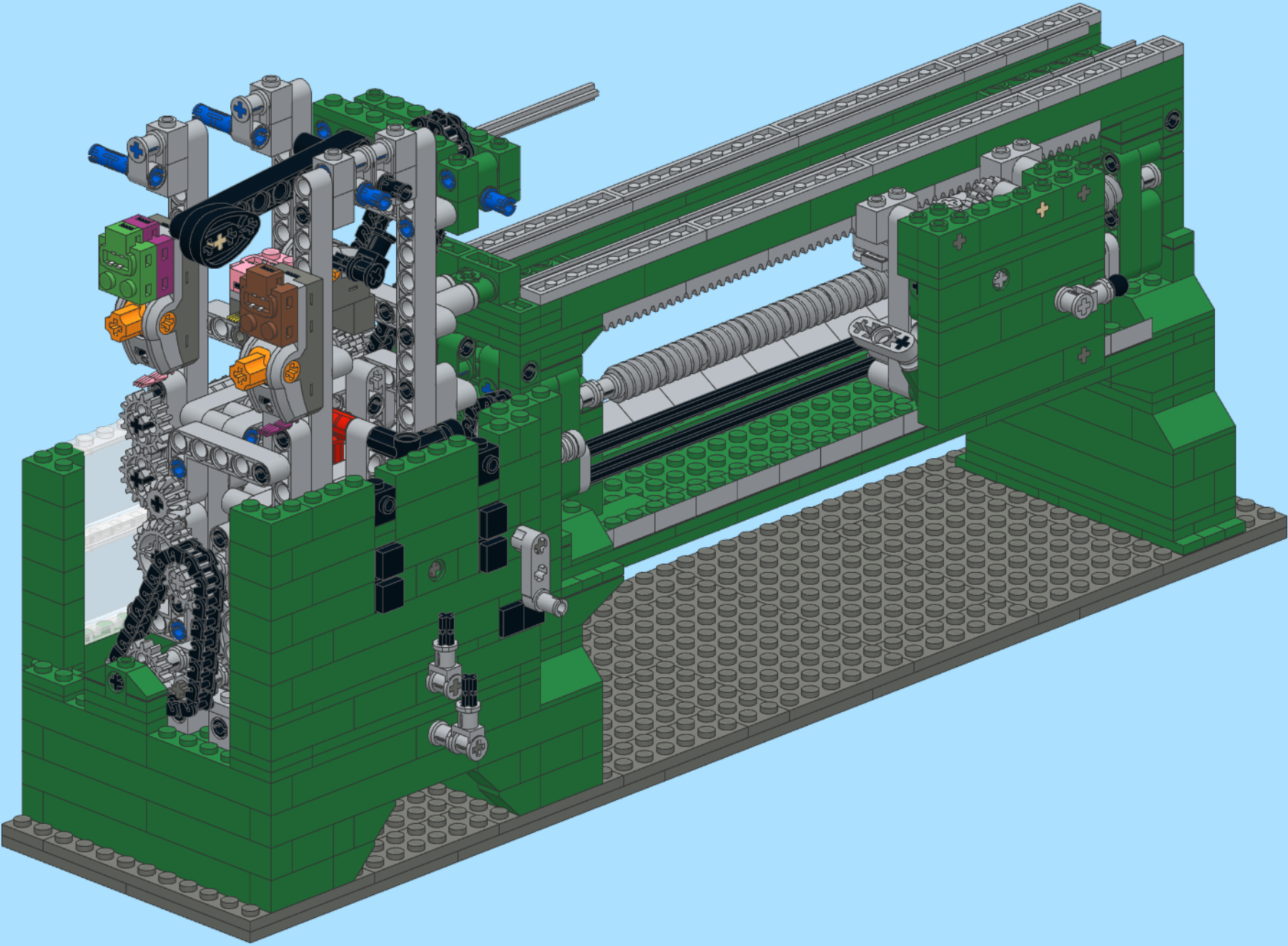

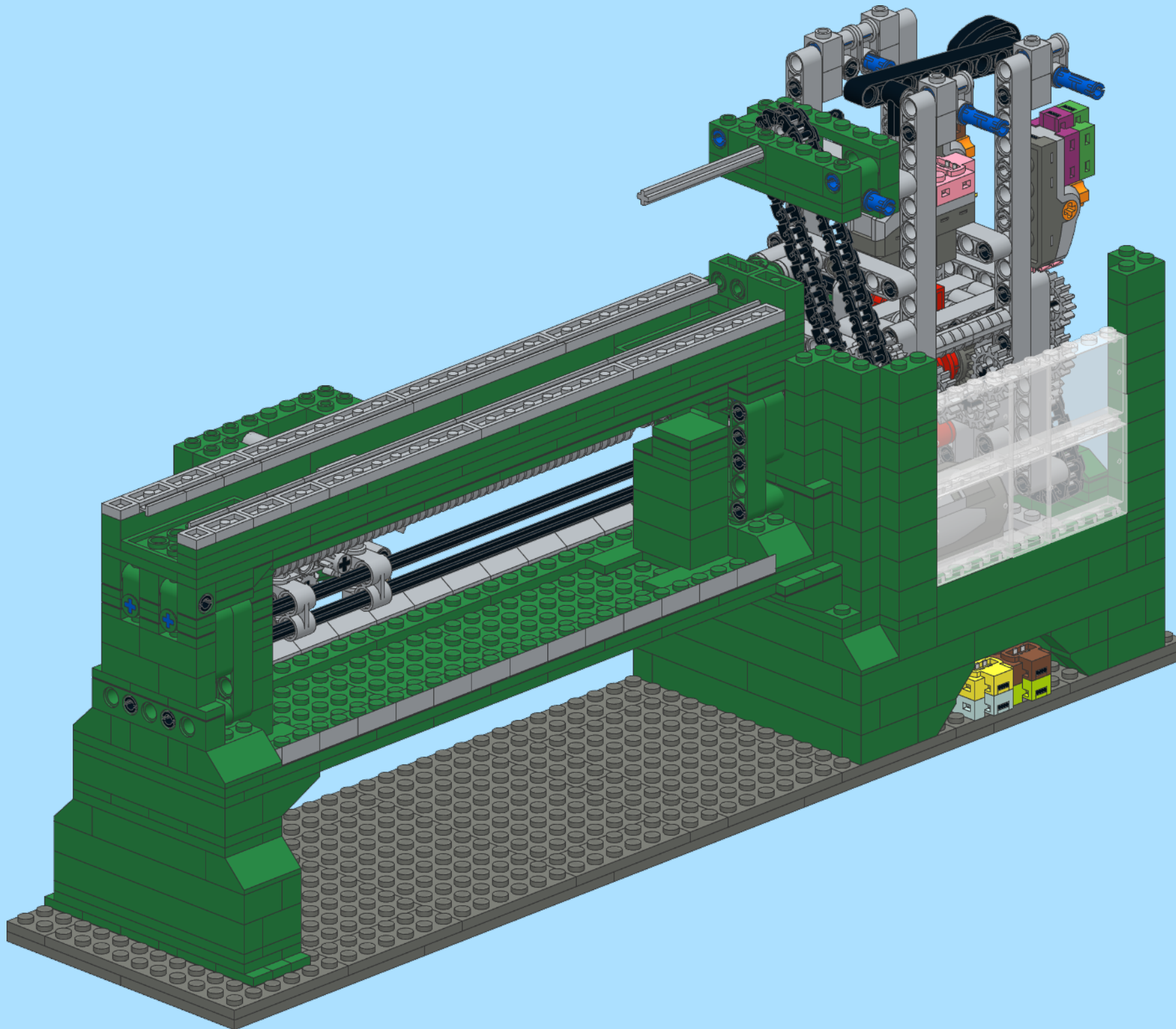
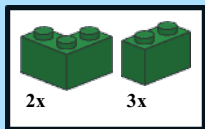

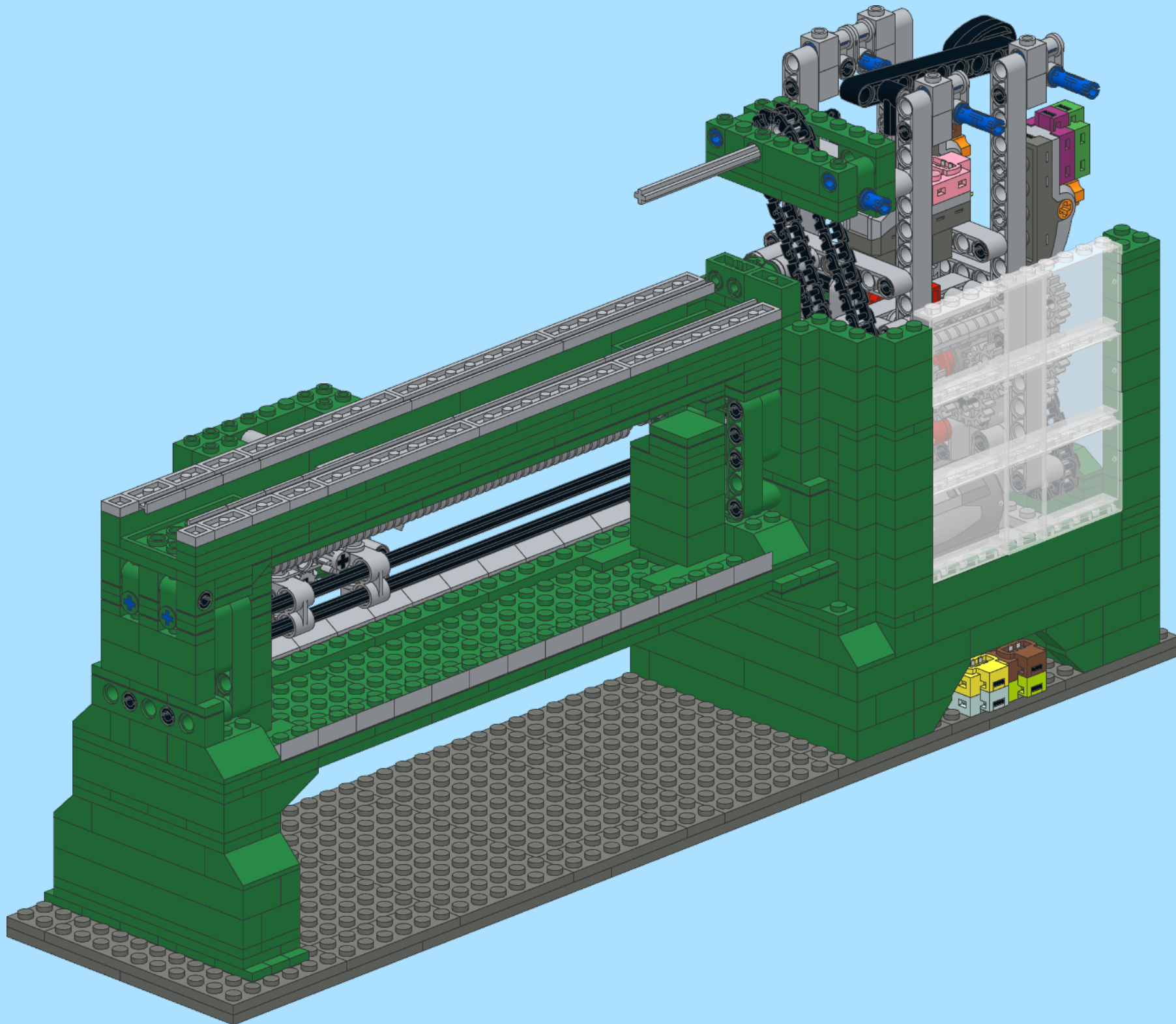
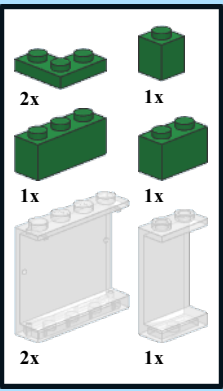

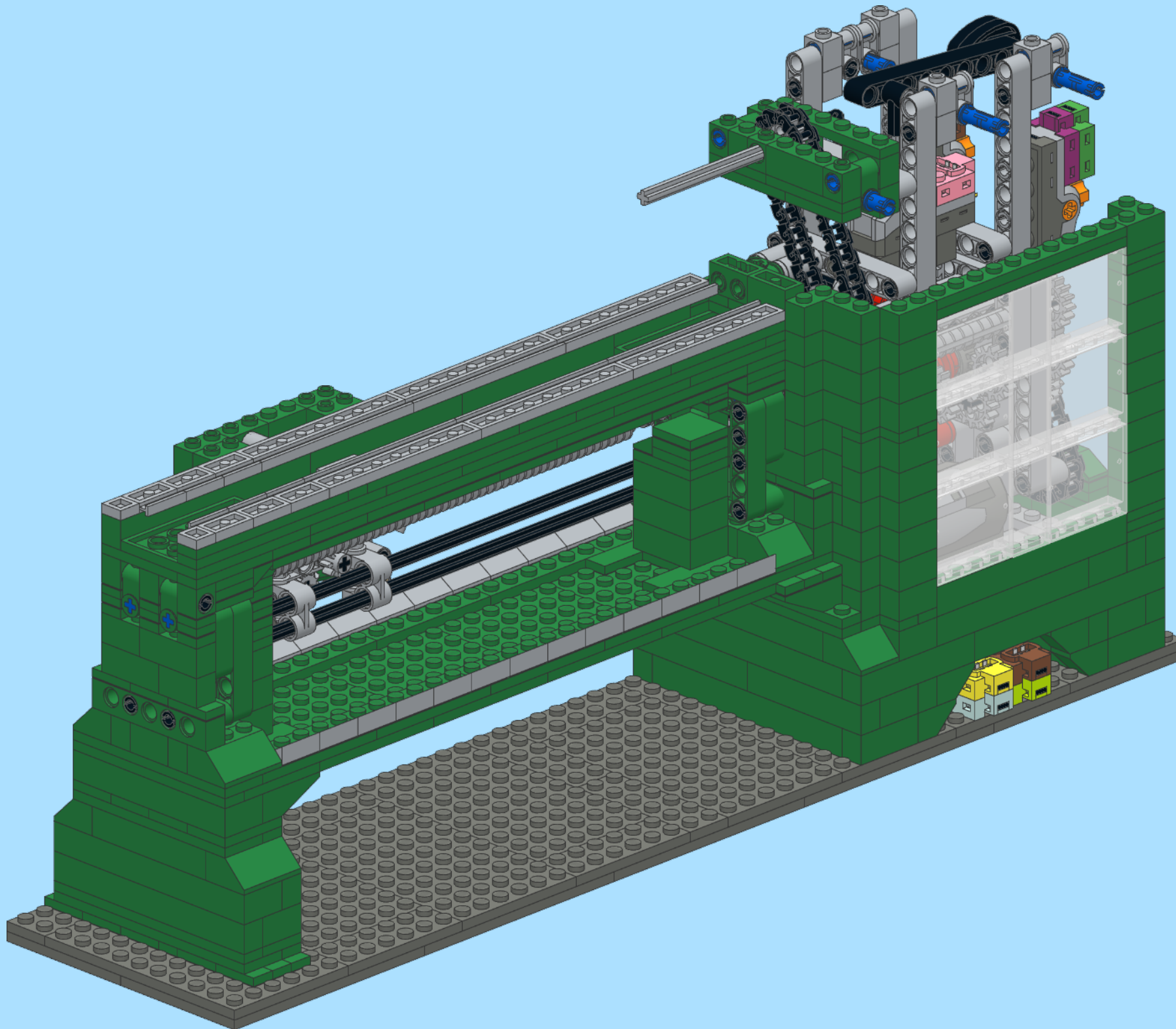
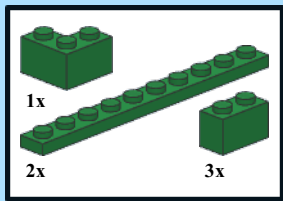

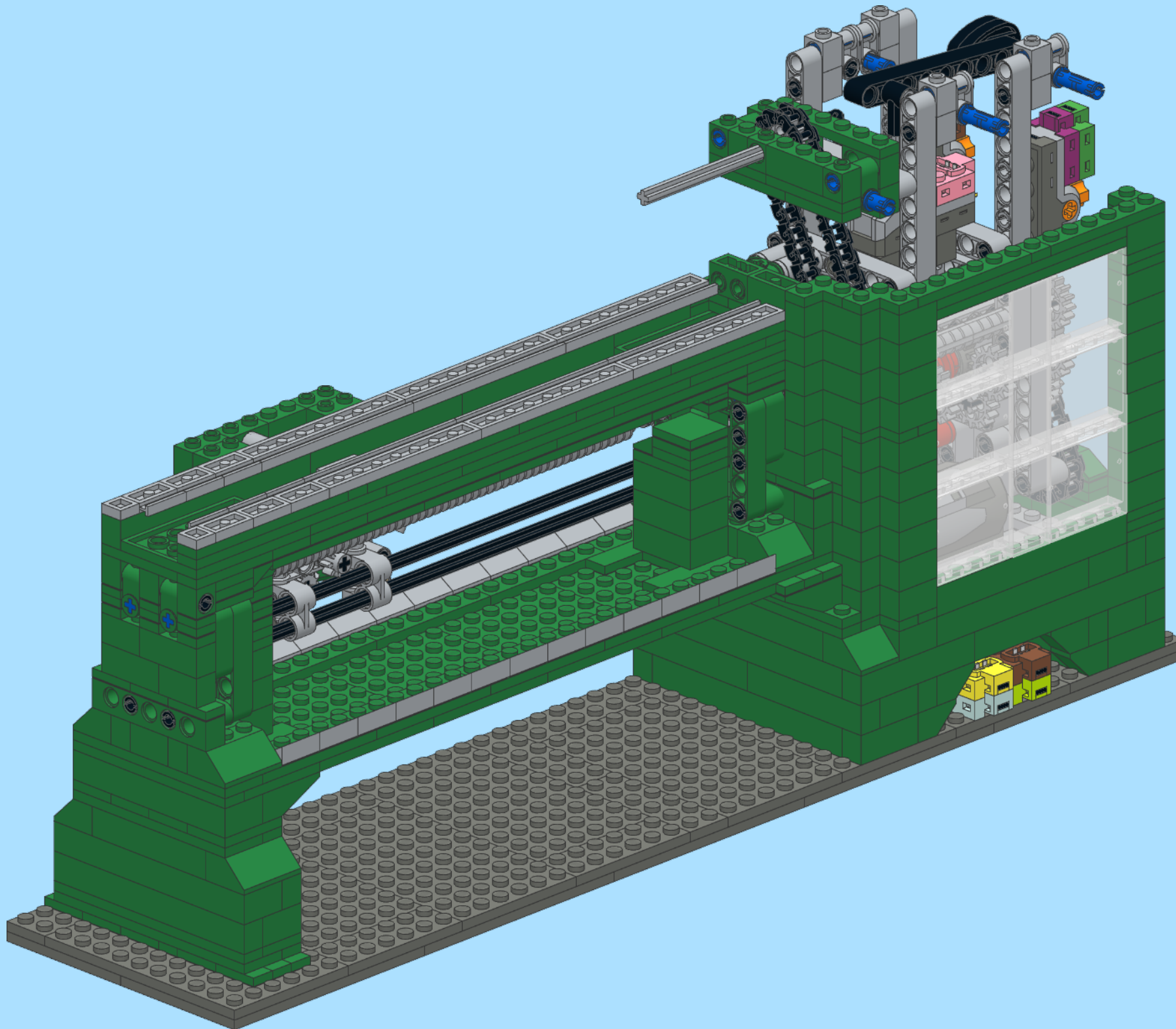
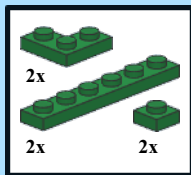

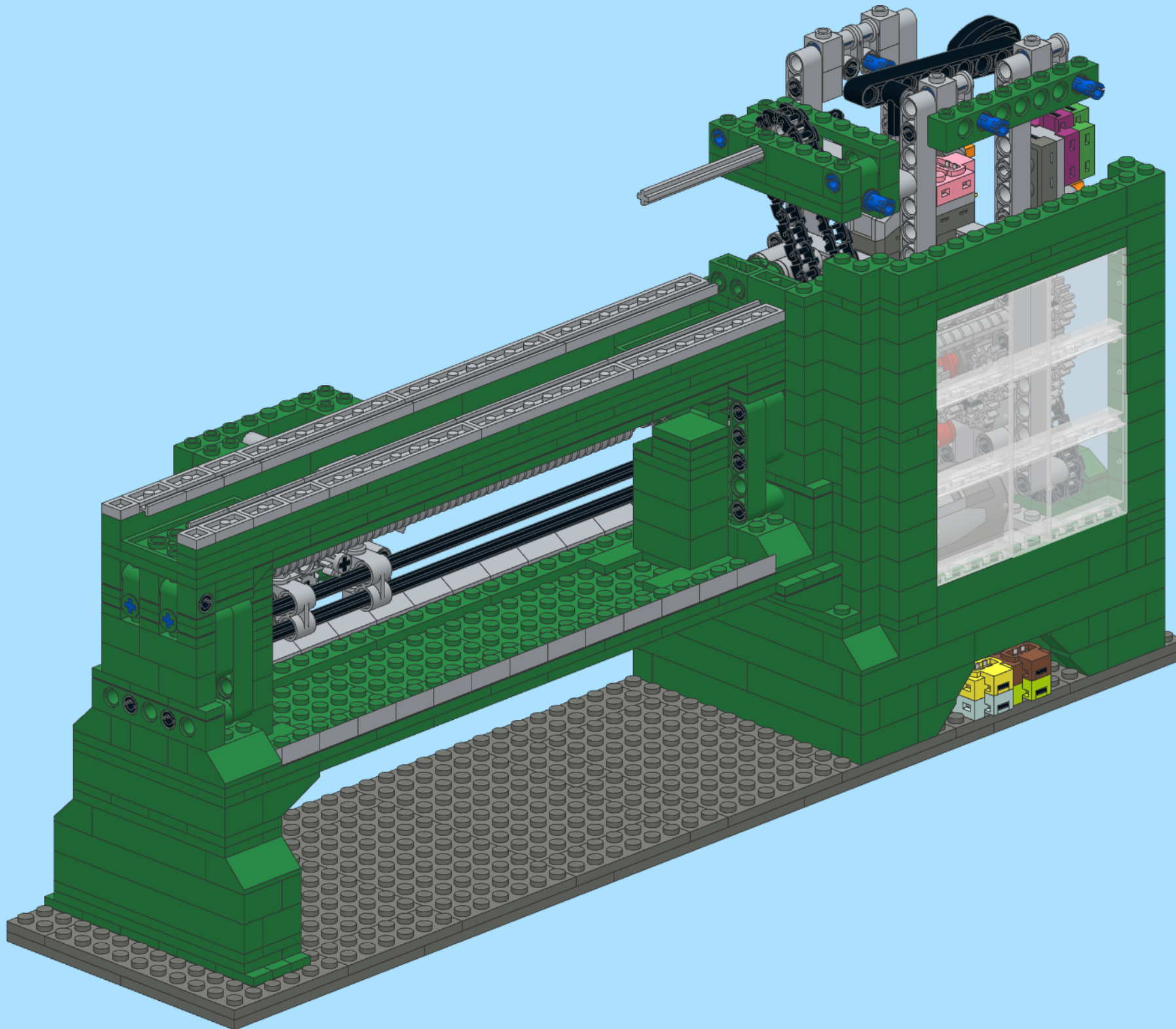
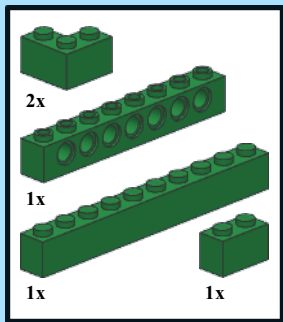

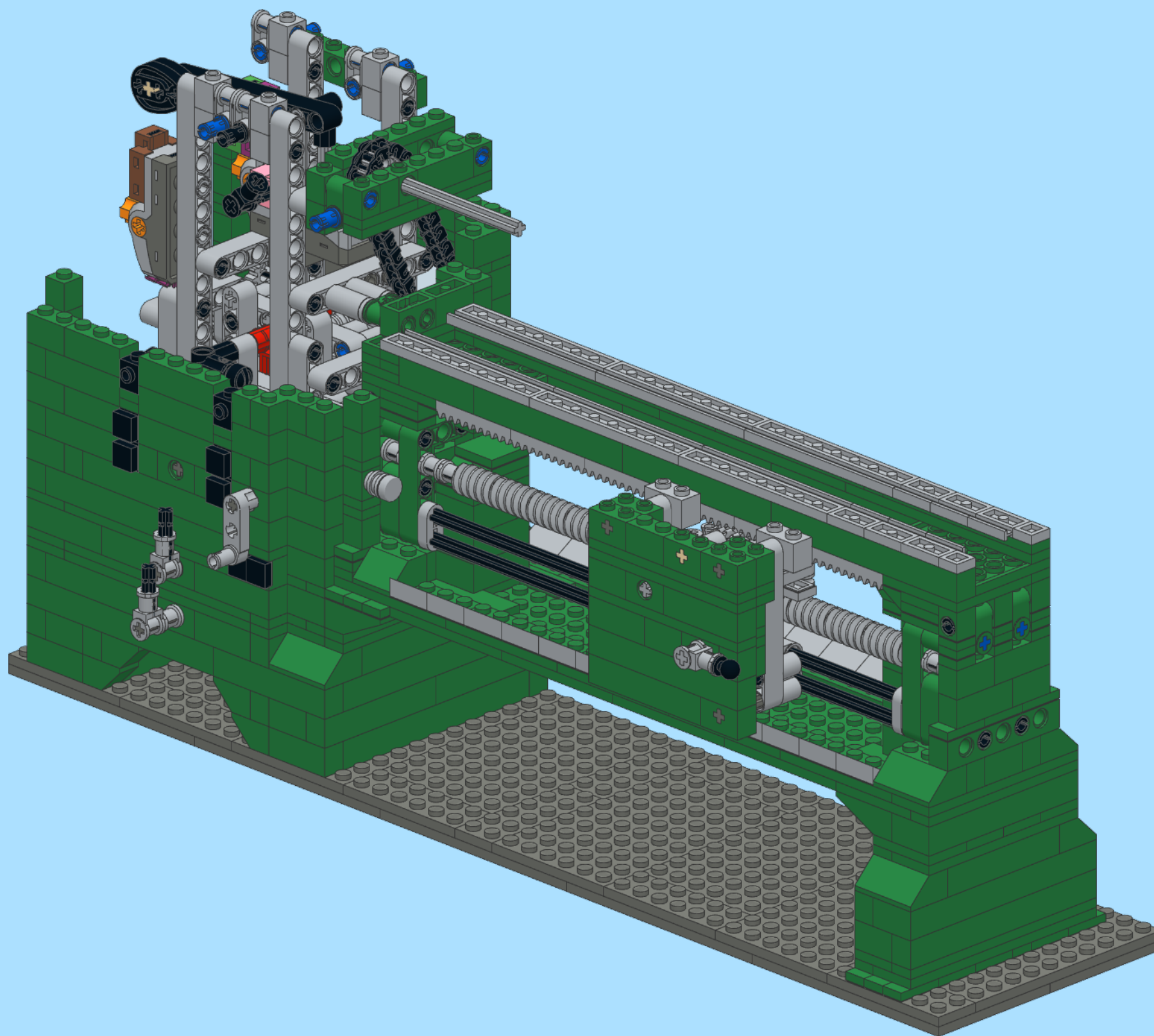



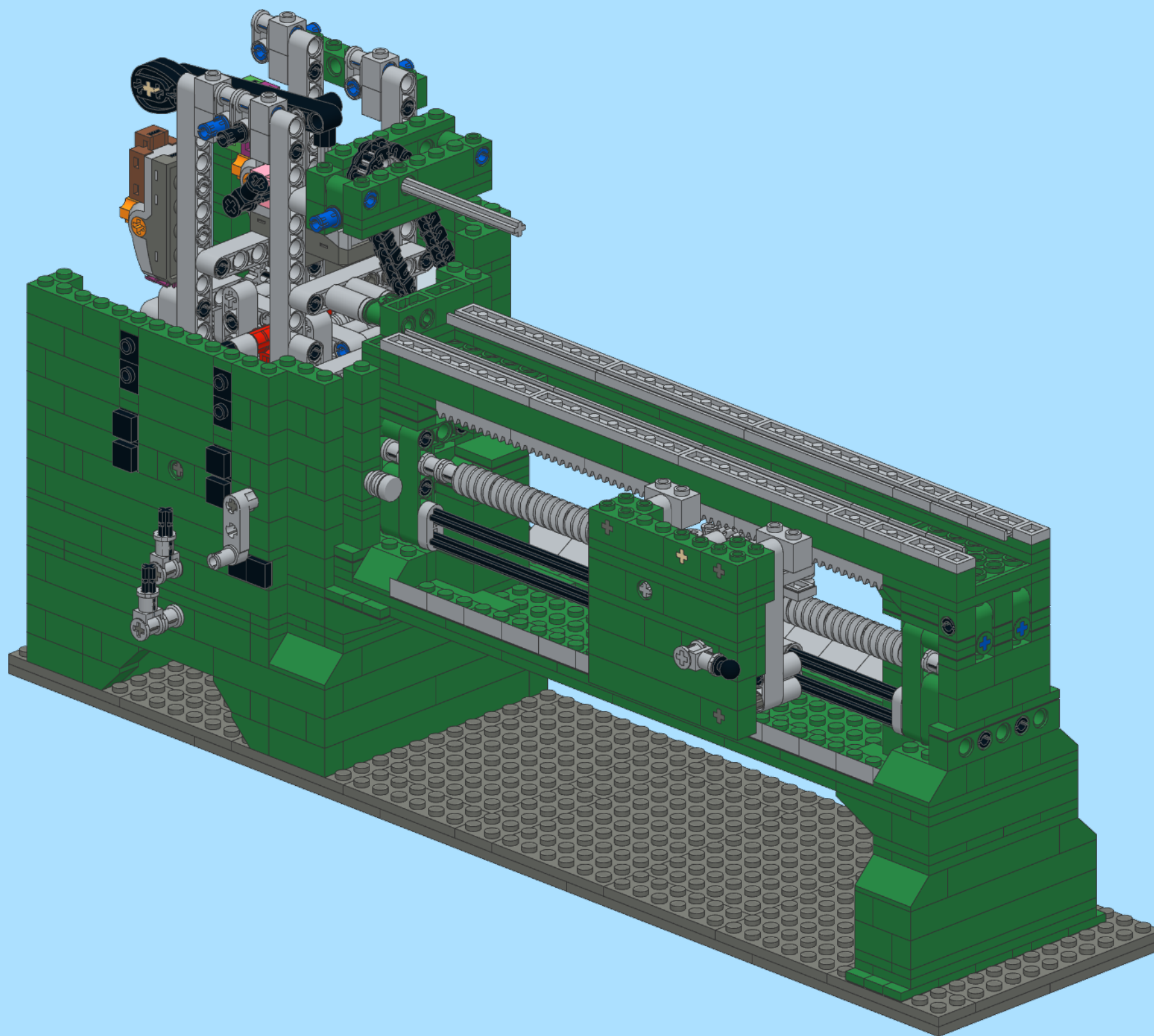
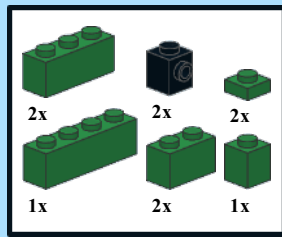

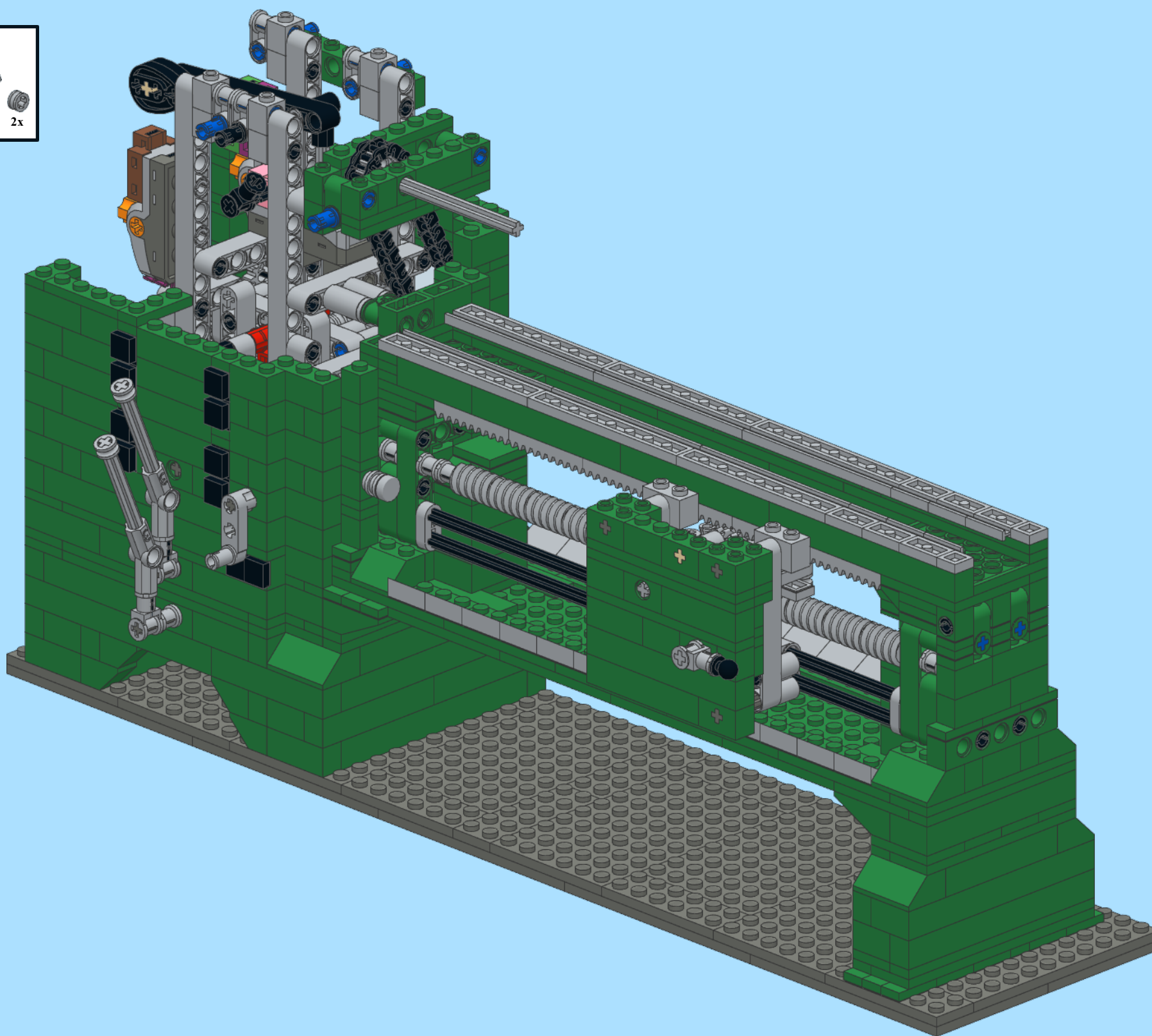
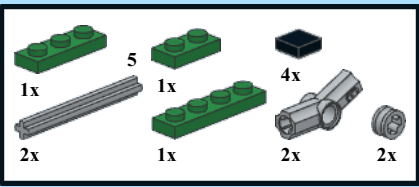

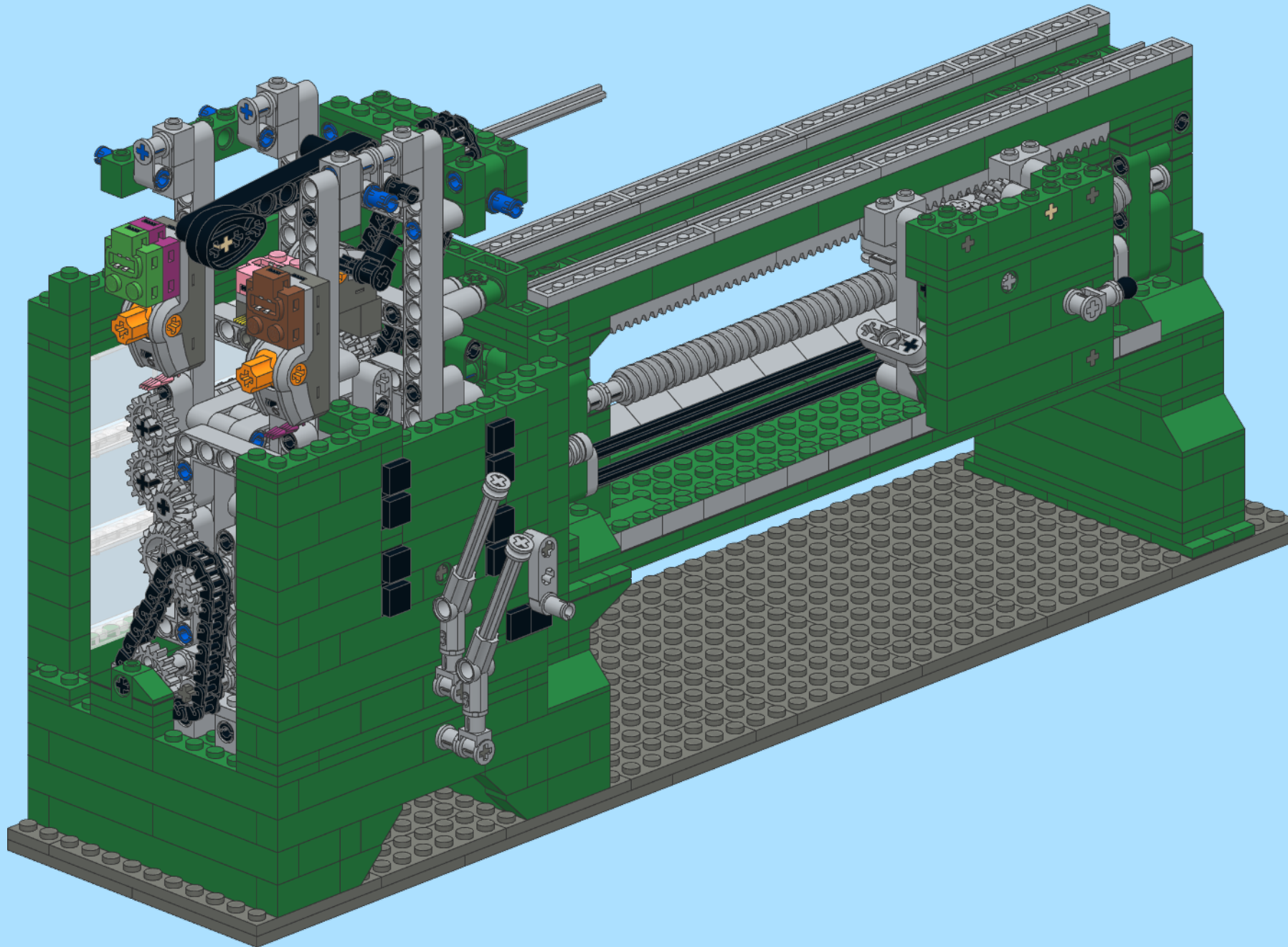
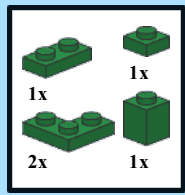

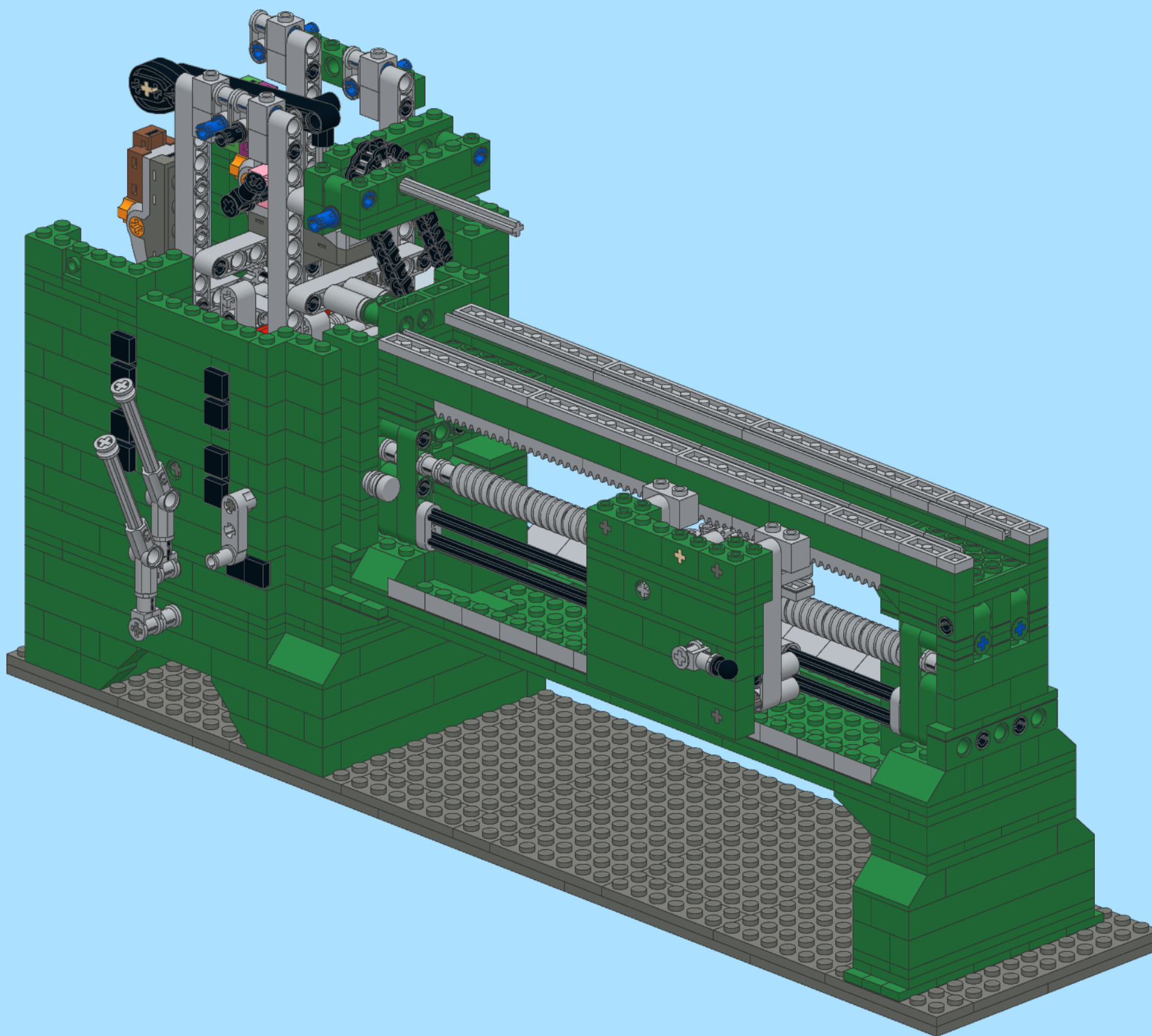
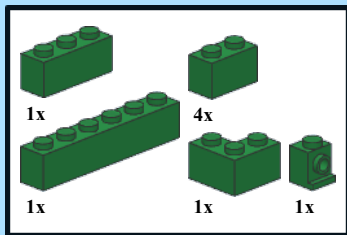

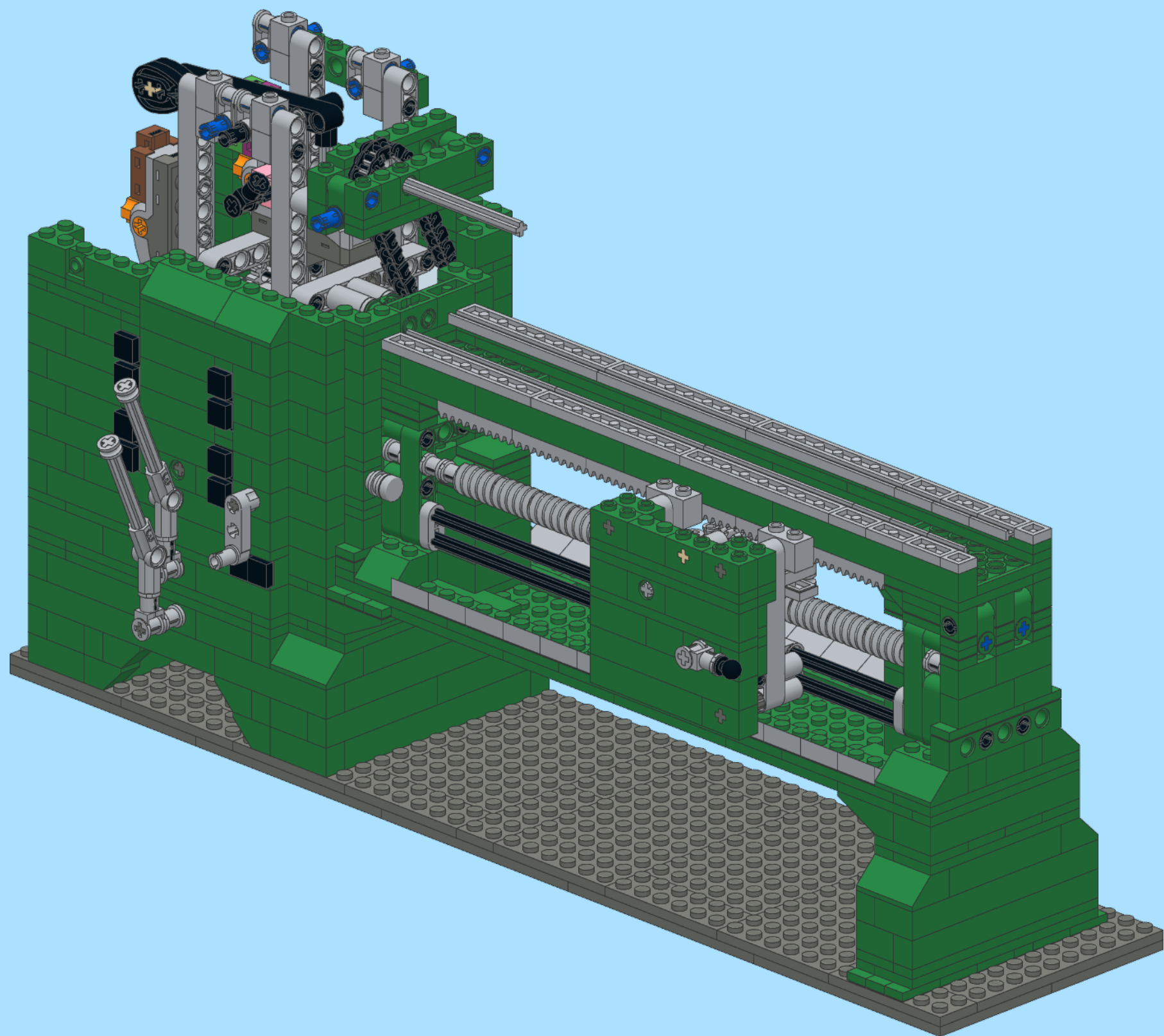
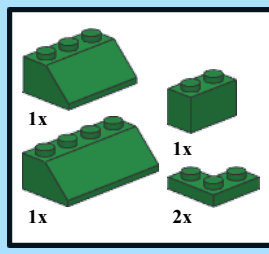

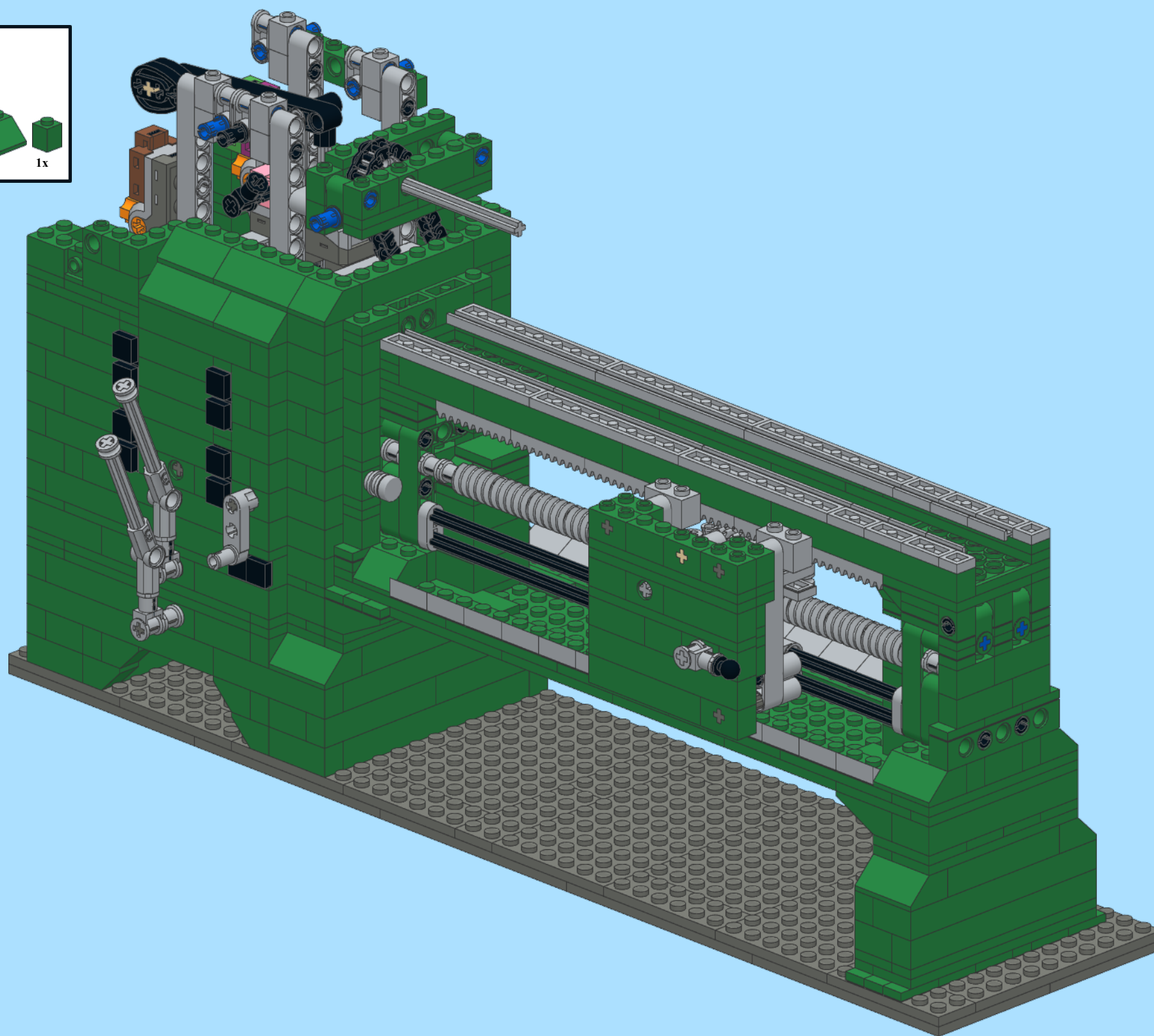
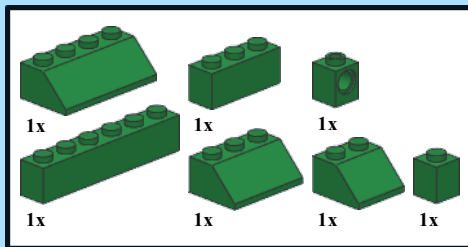

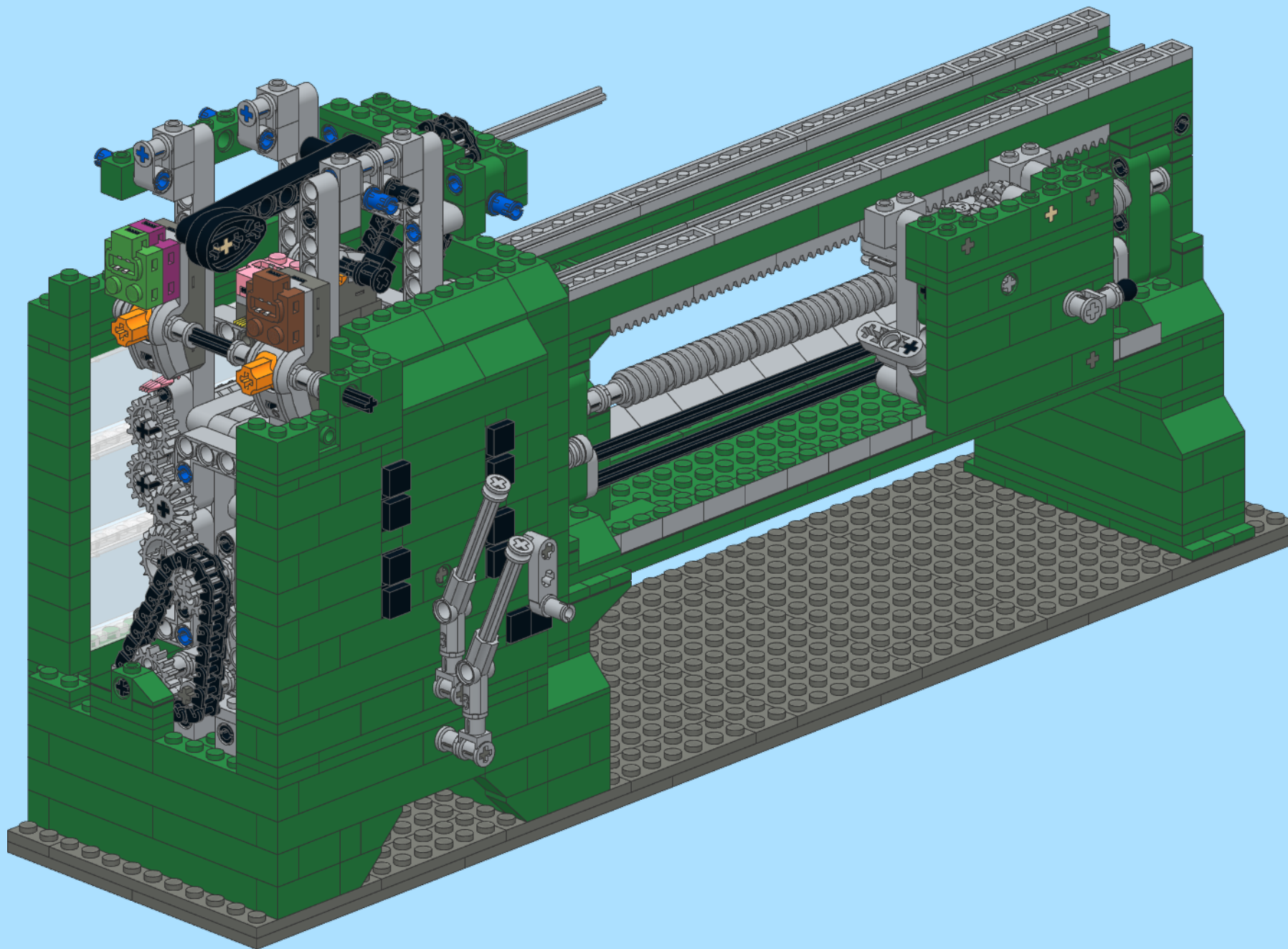
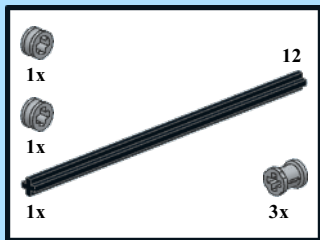

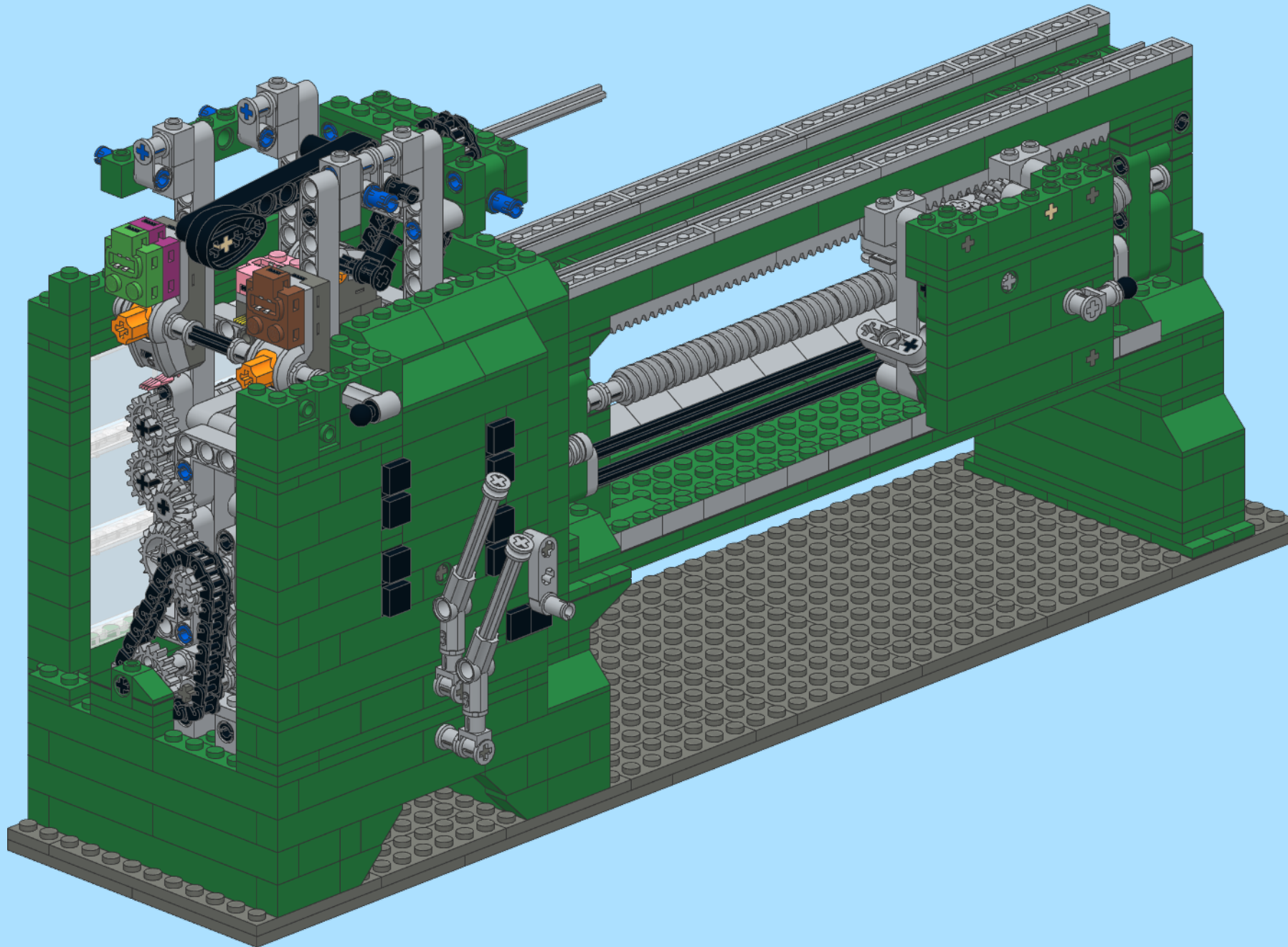



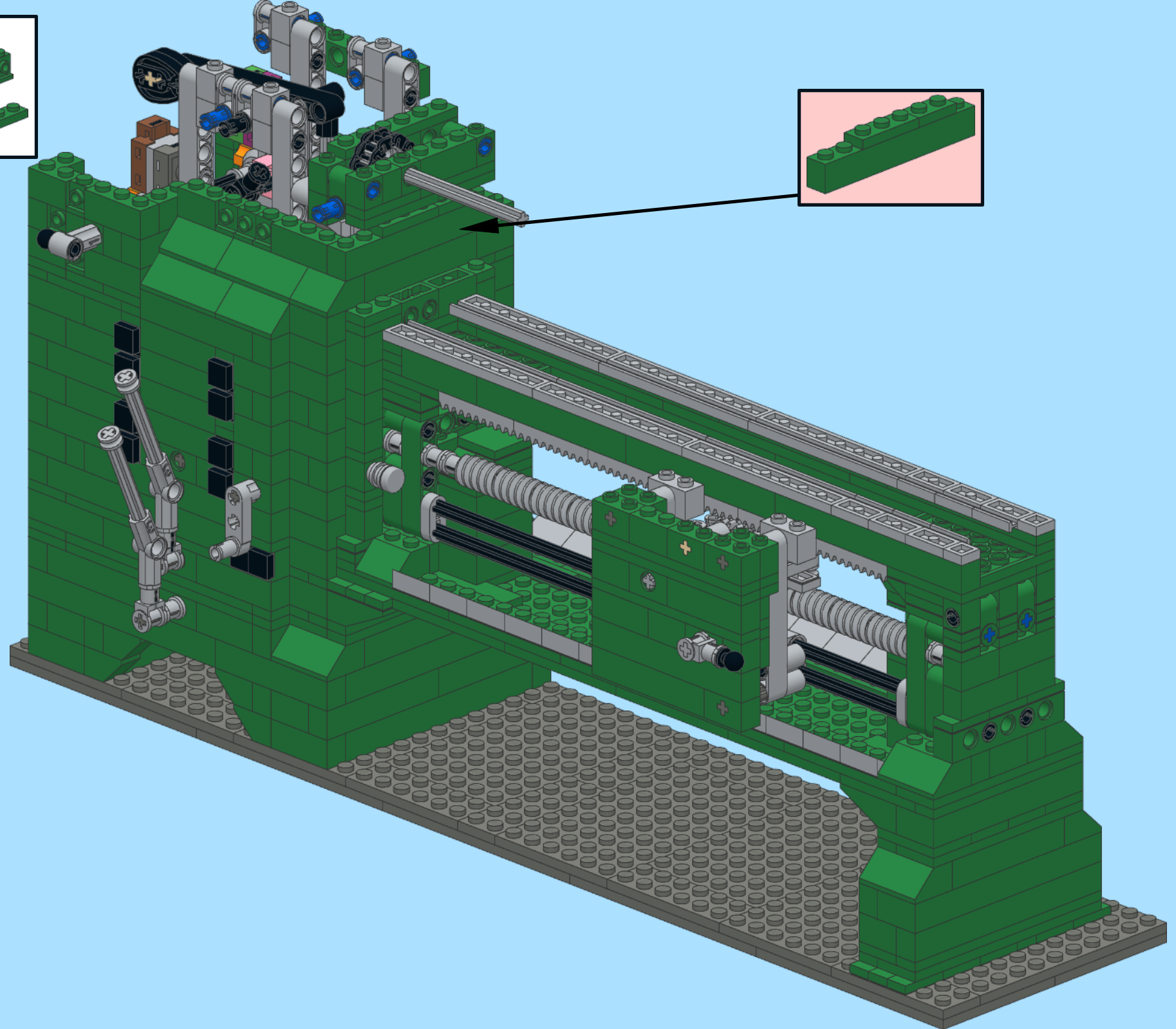
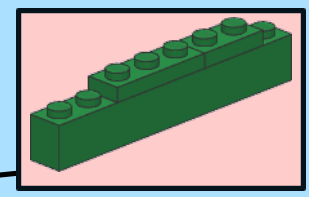
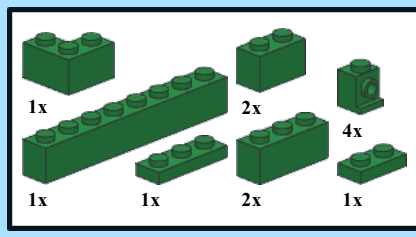

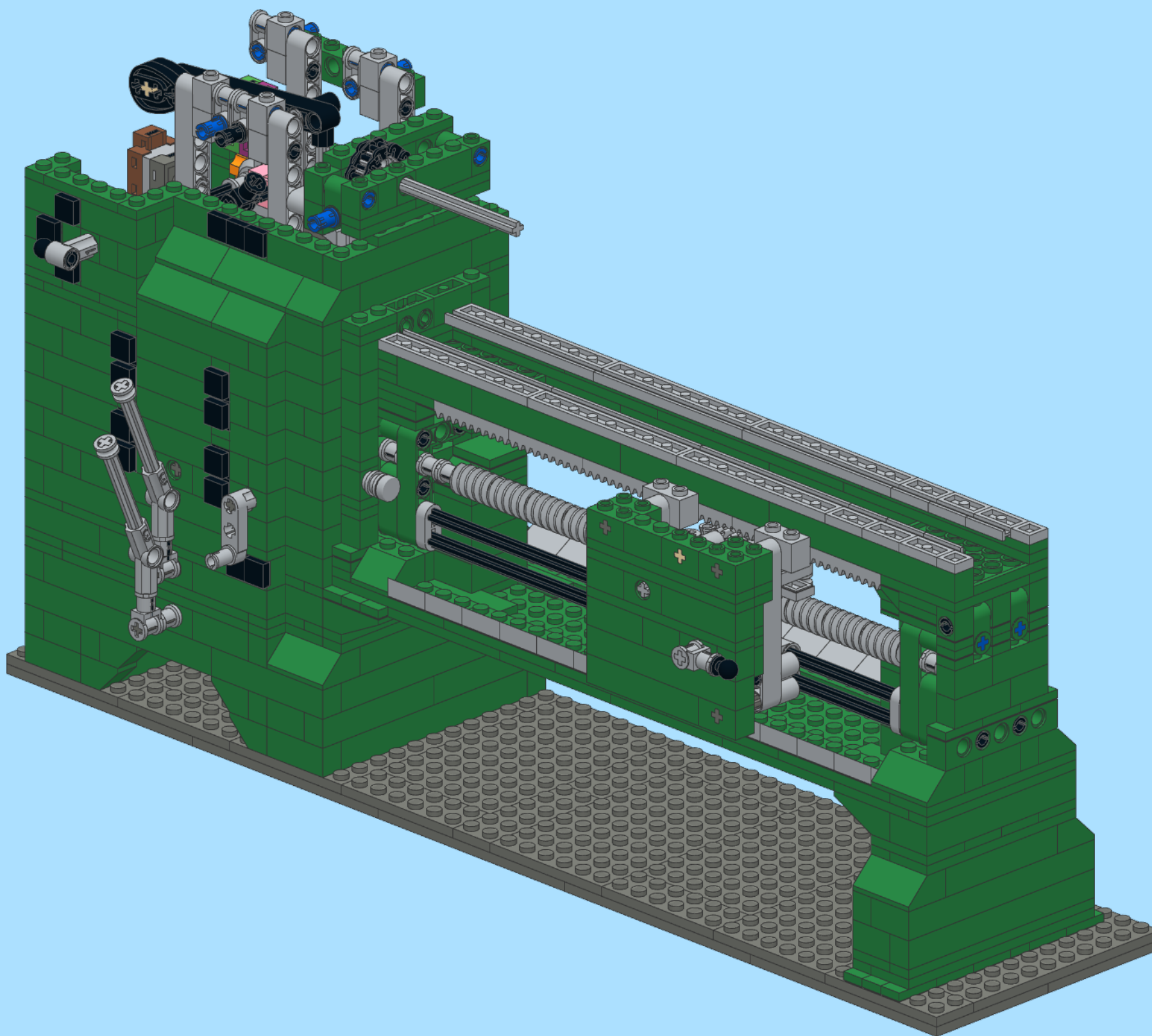
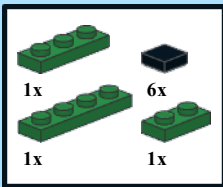

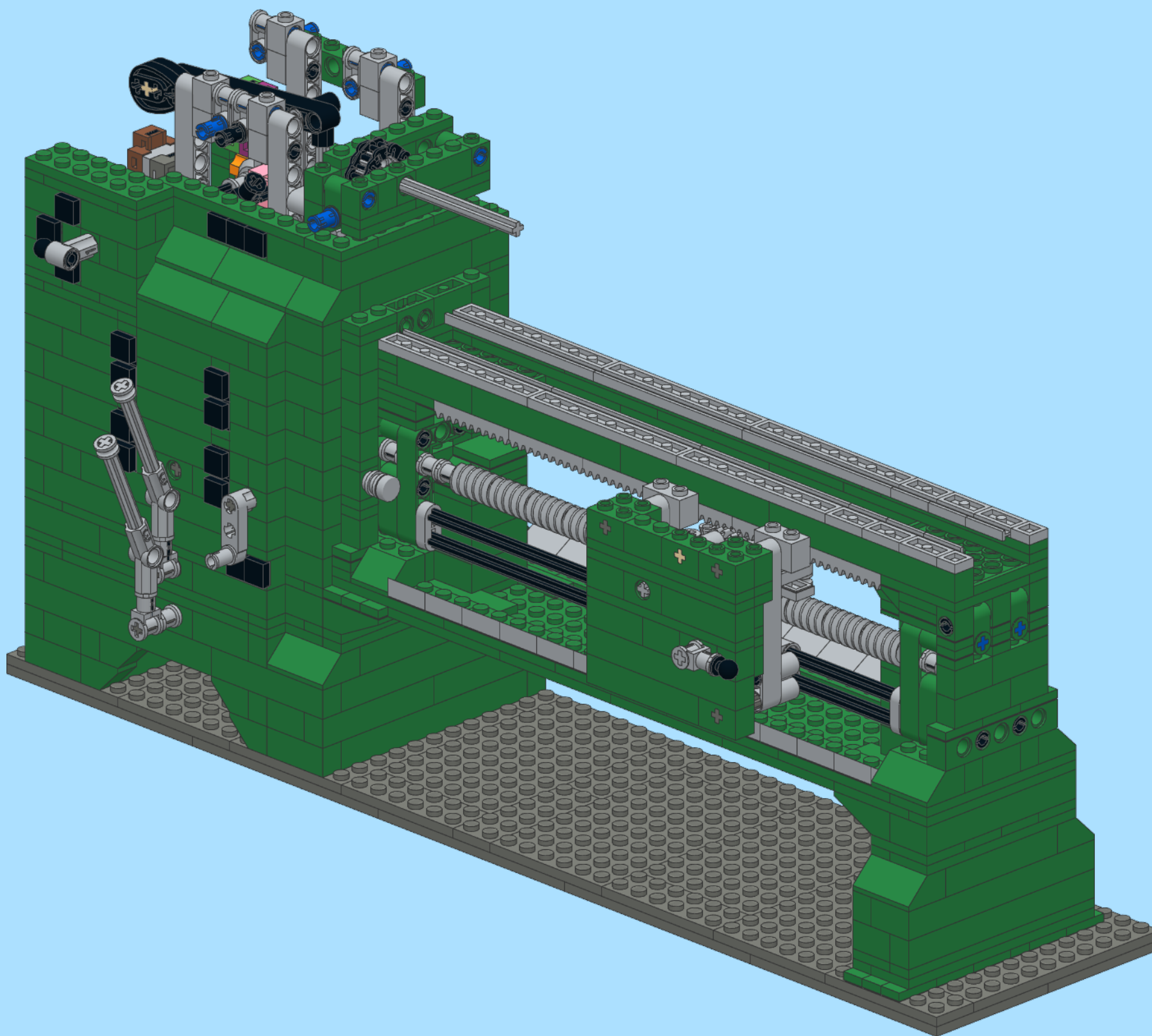
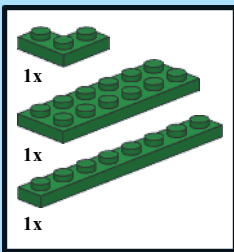

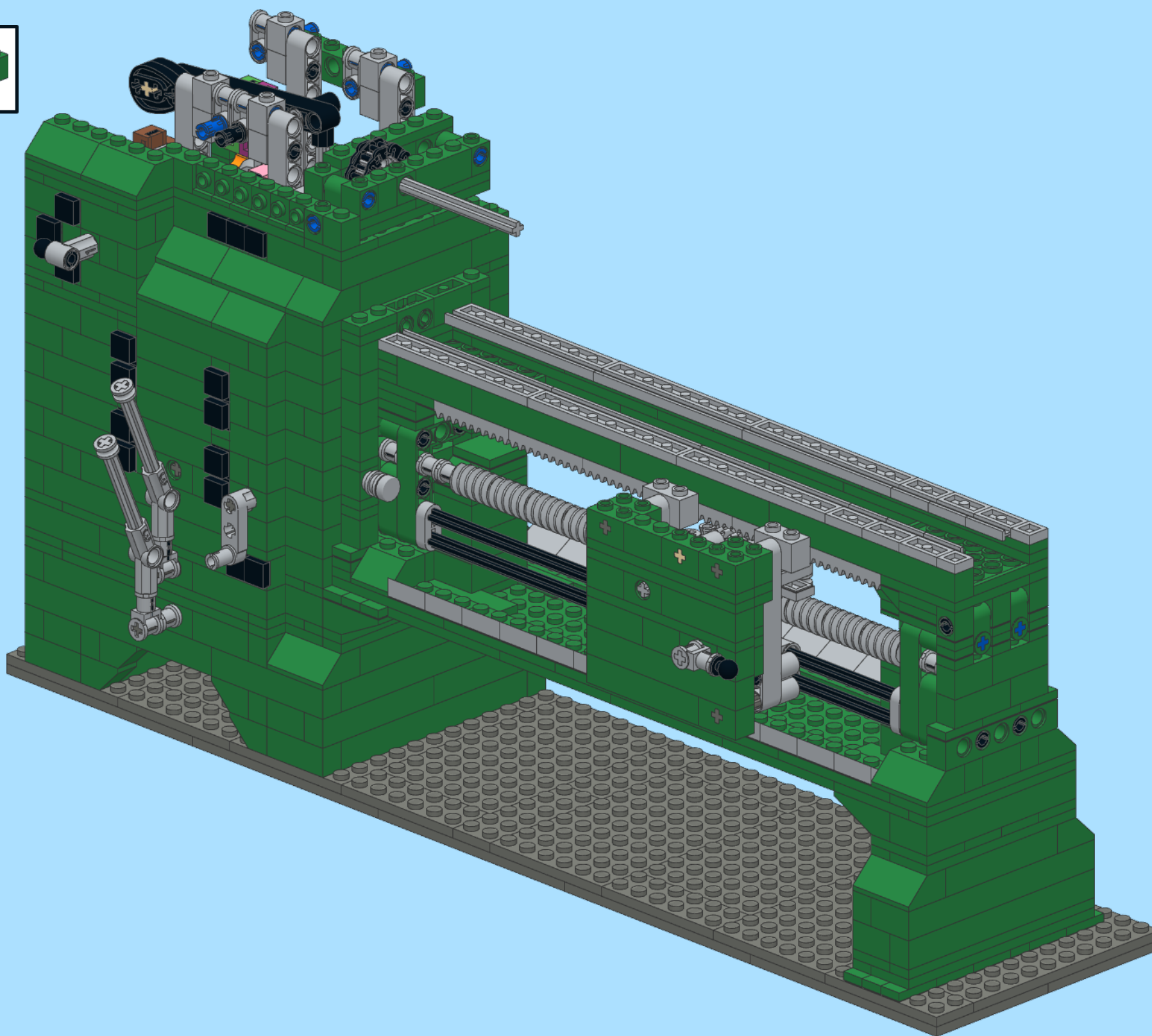
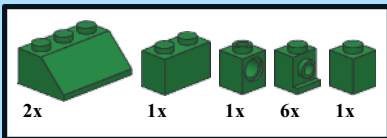







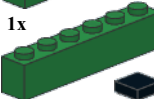

-  2x
-  1x
-  1x
-  1x
-  1x
-  1x
-  6x

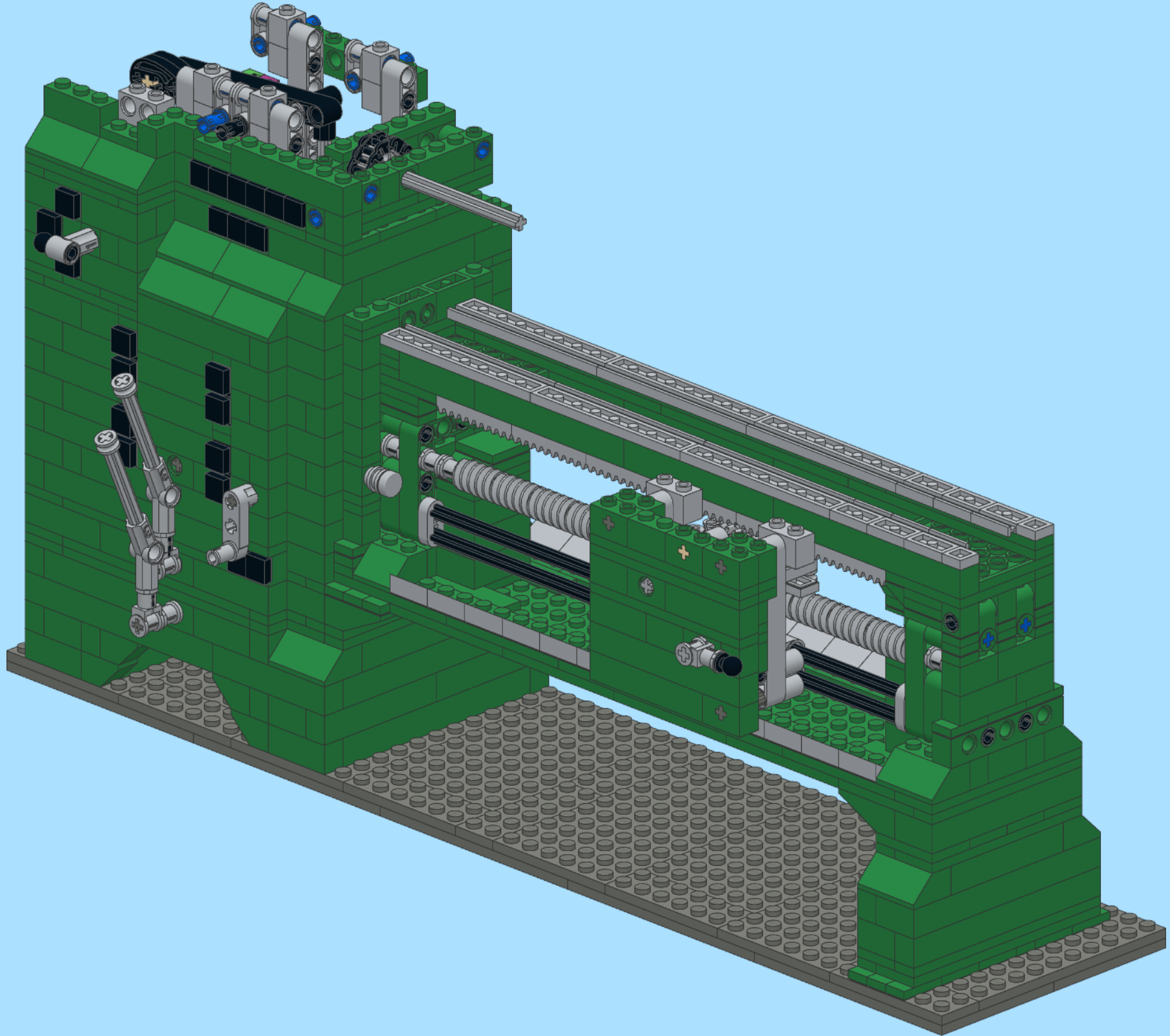

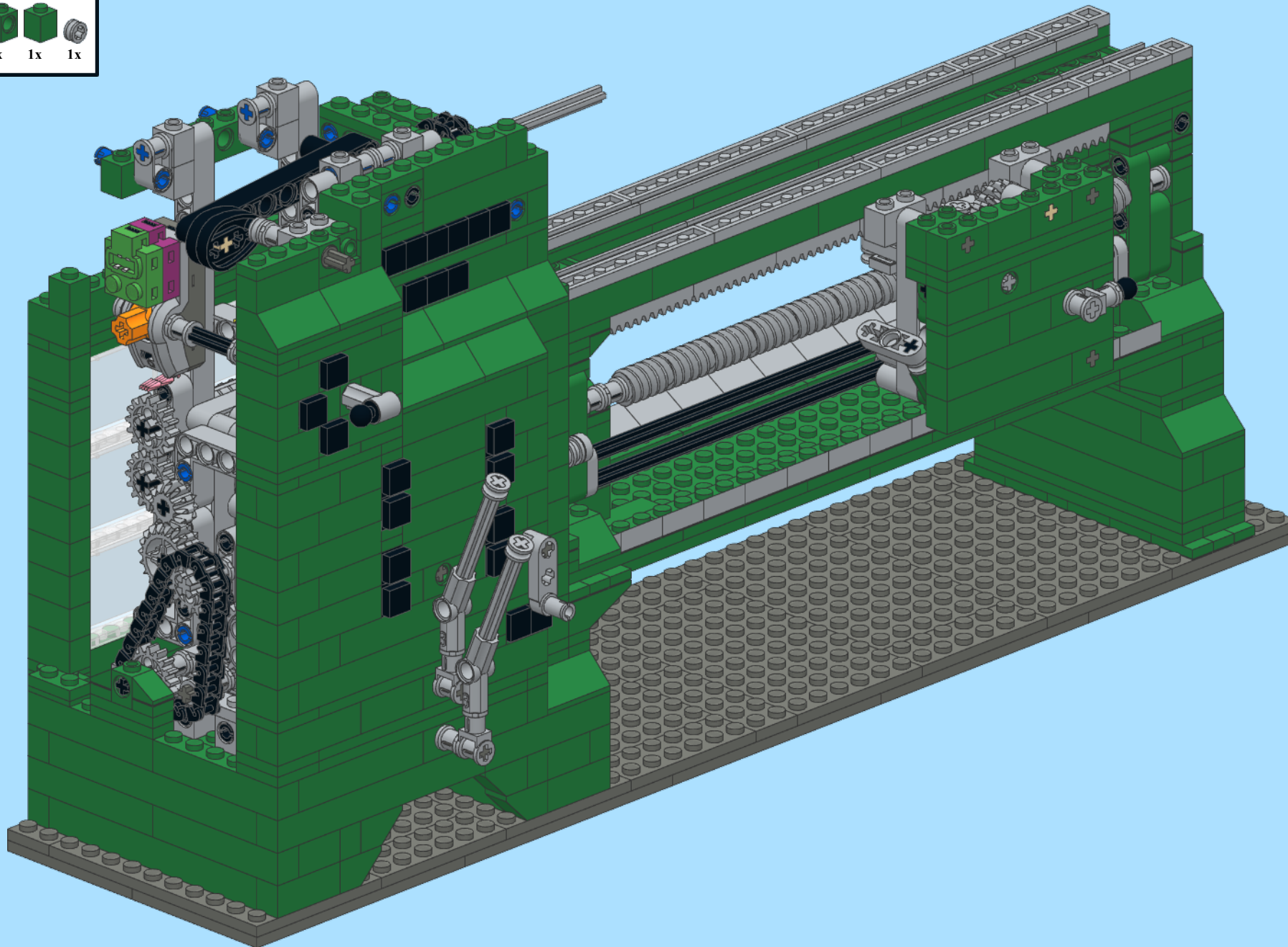
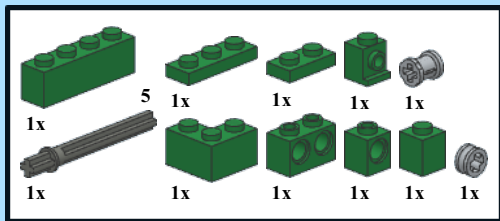

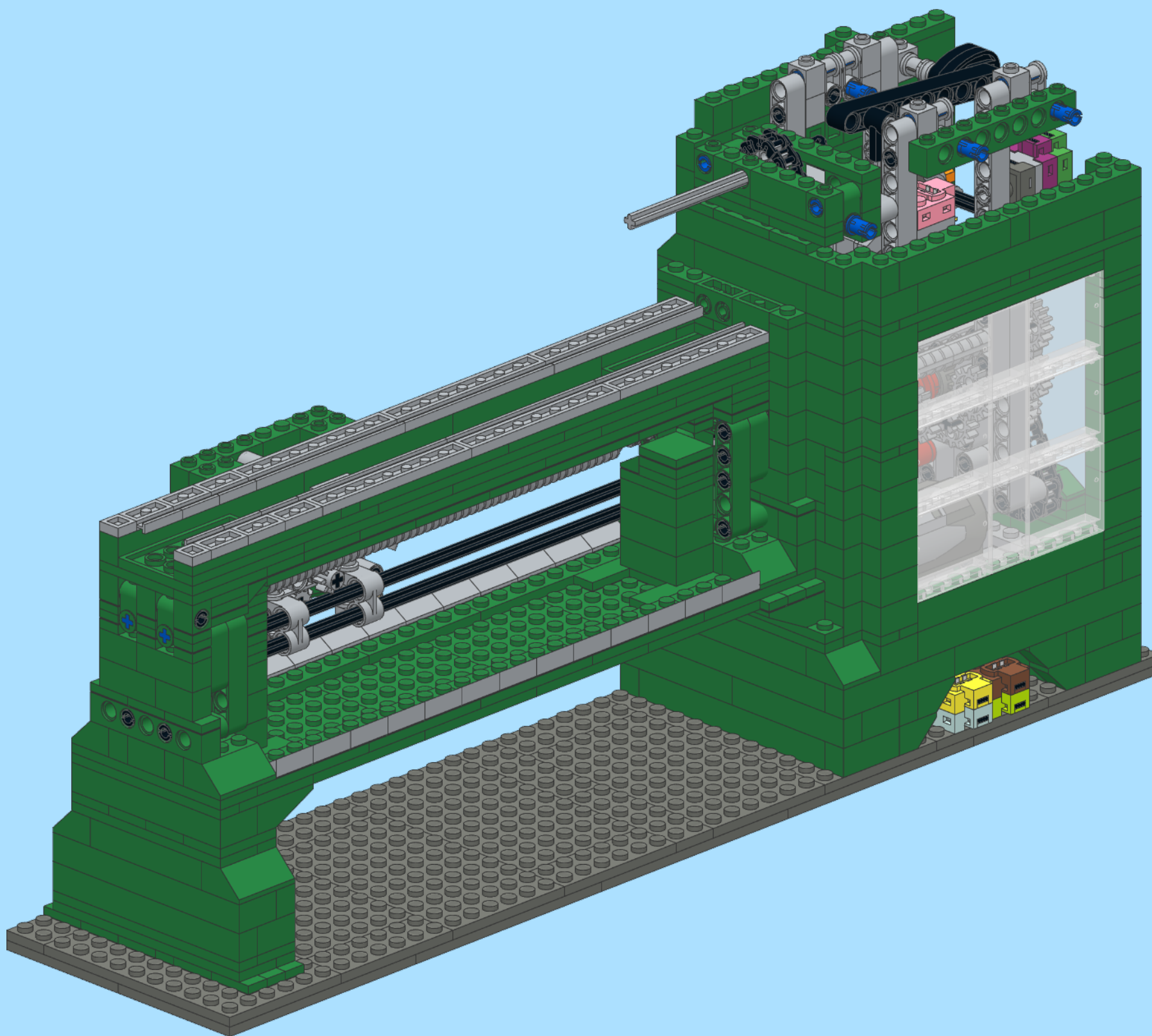
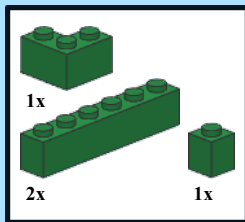

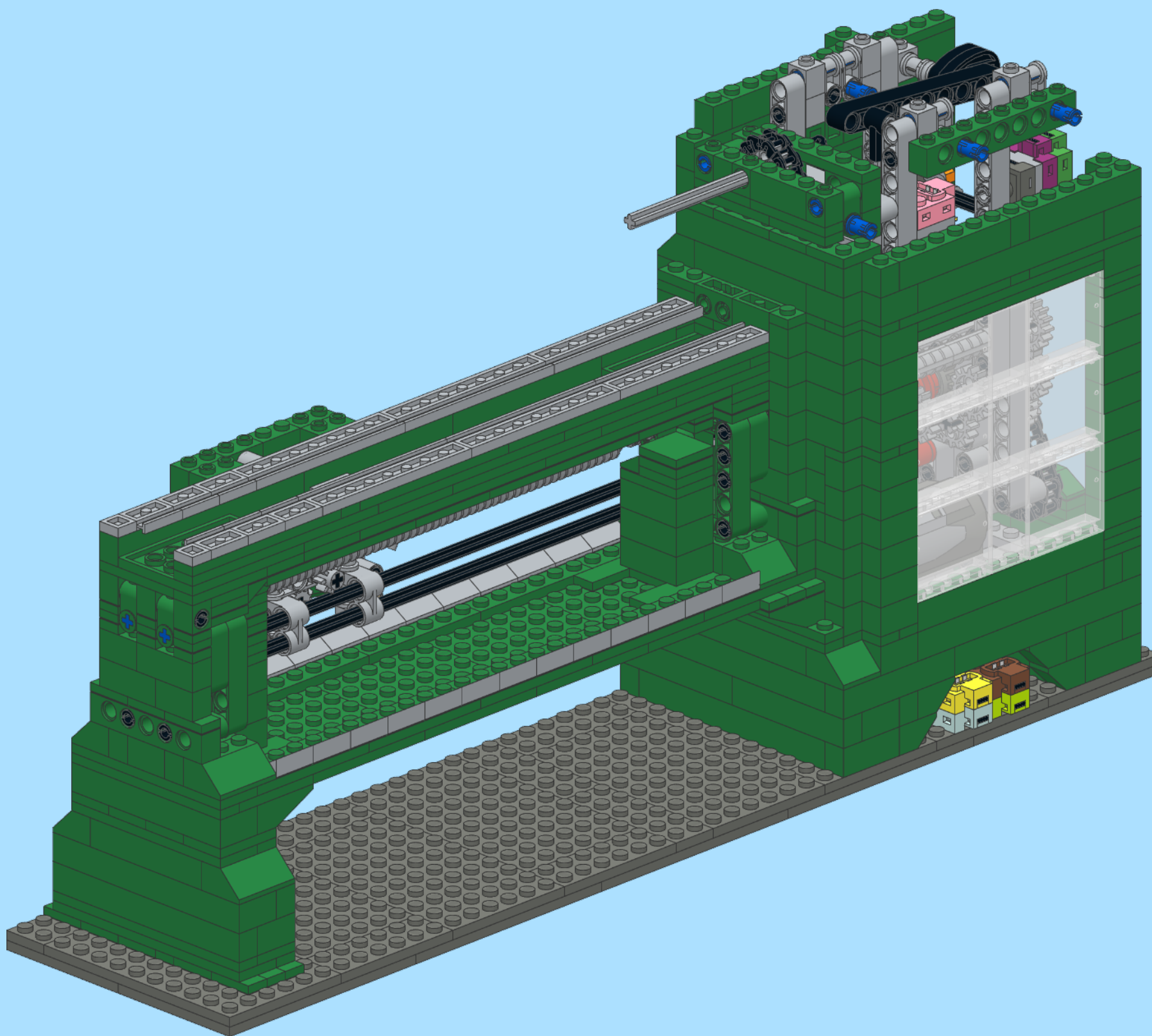
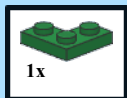



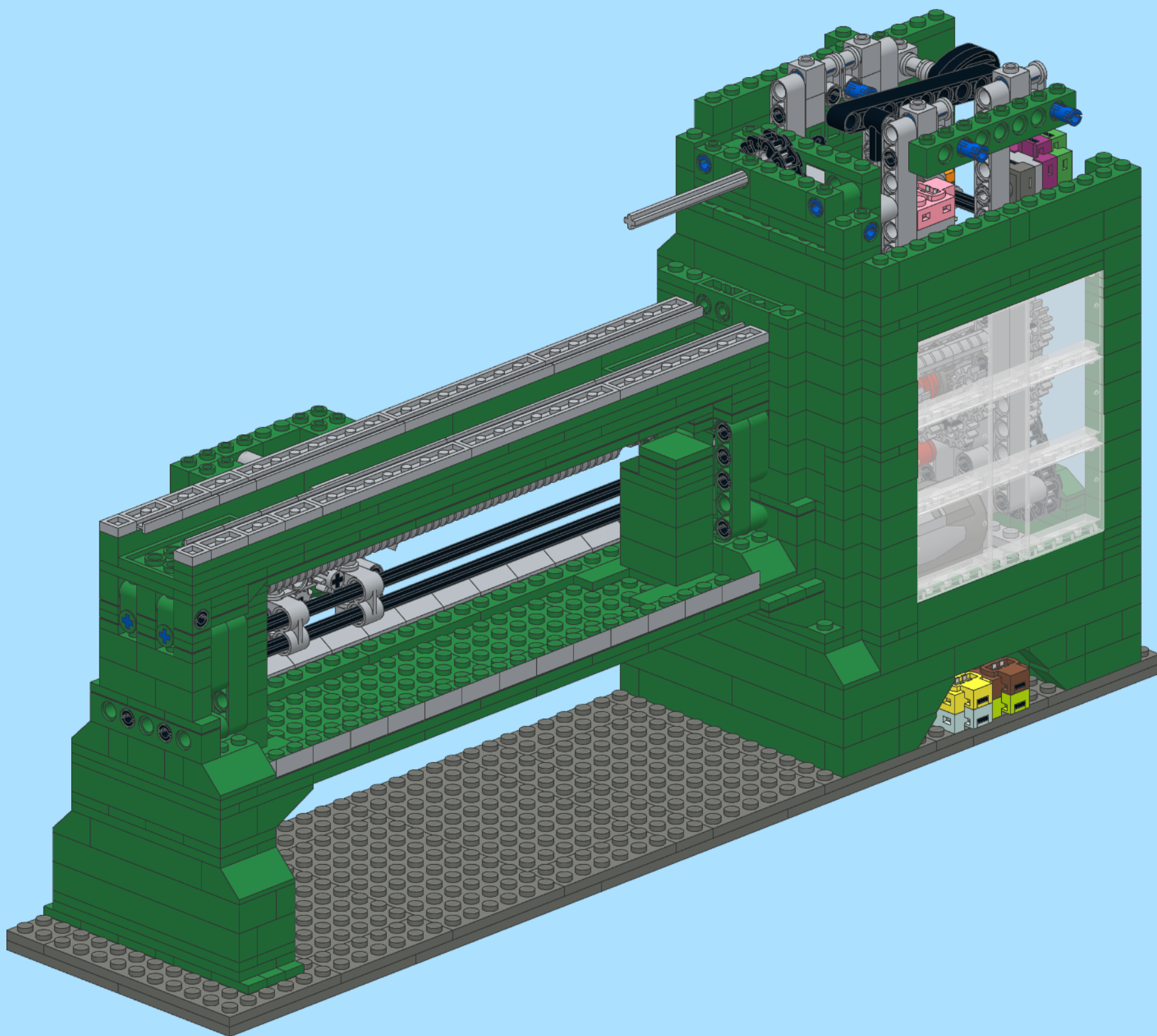
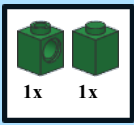

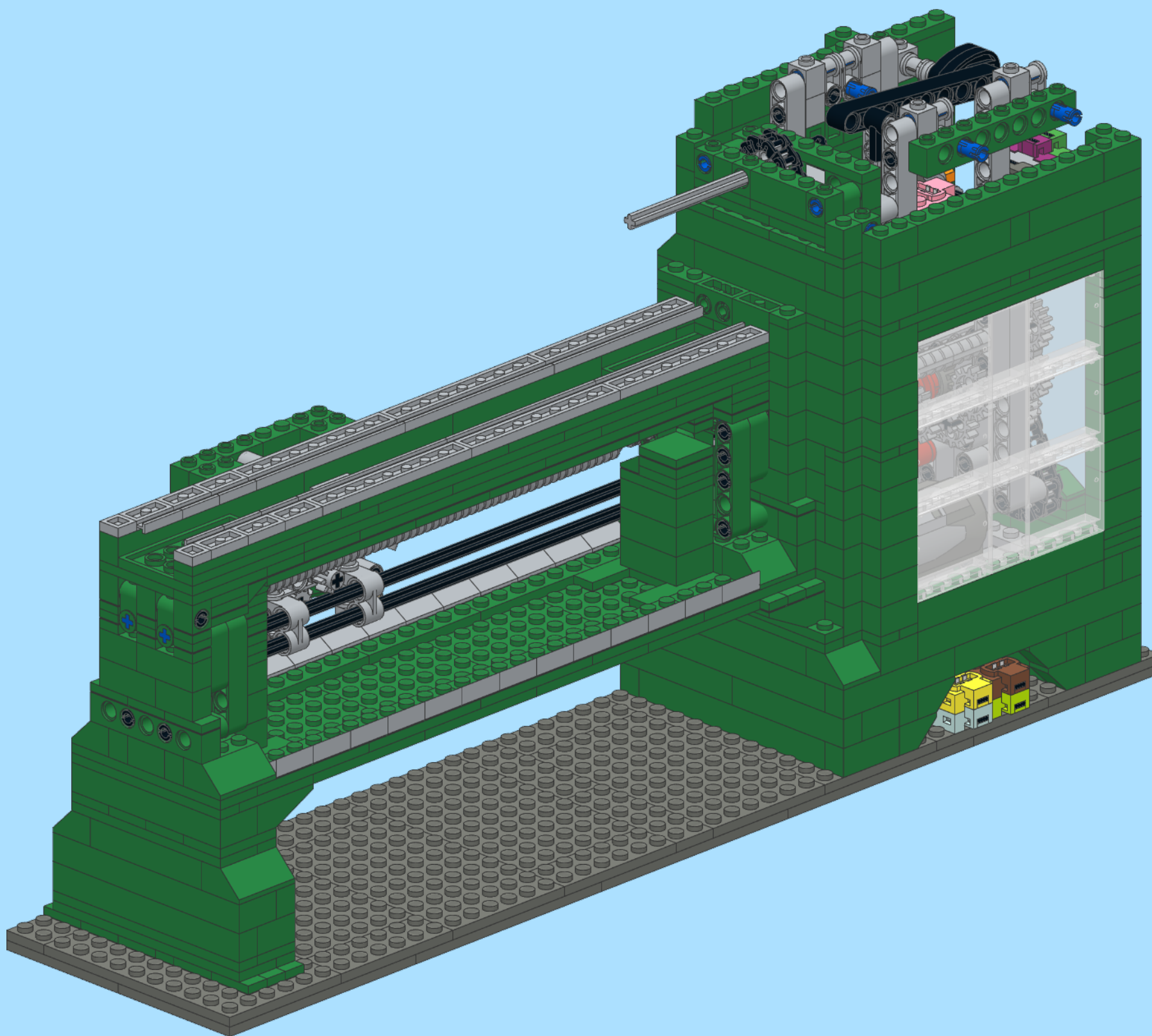
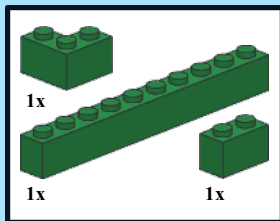

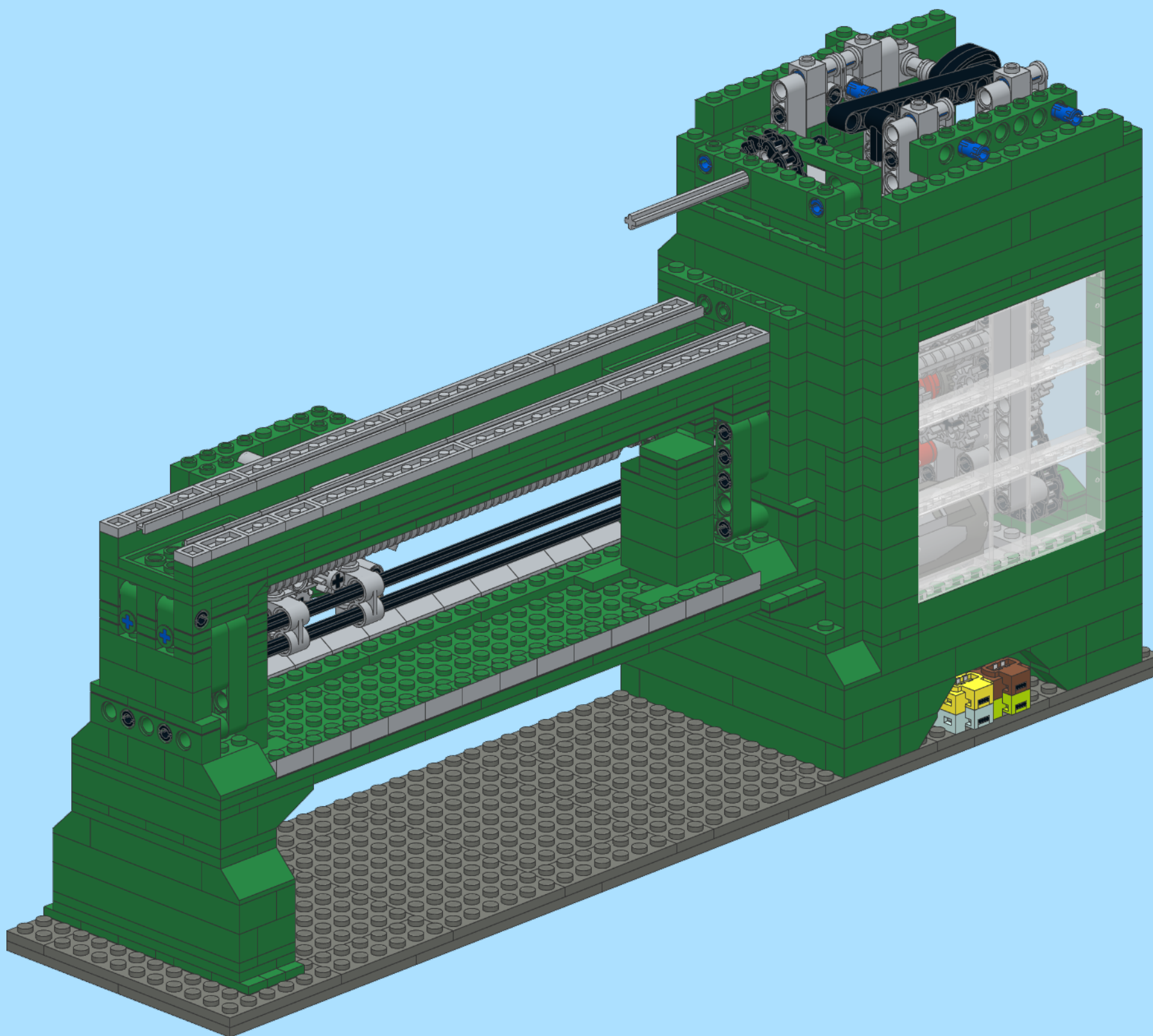
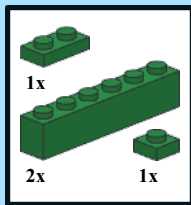

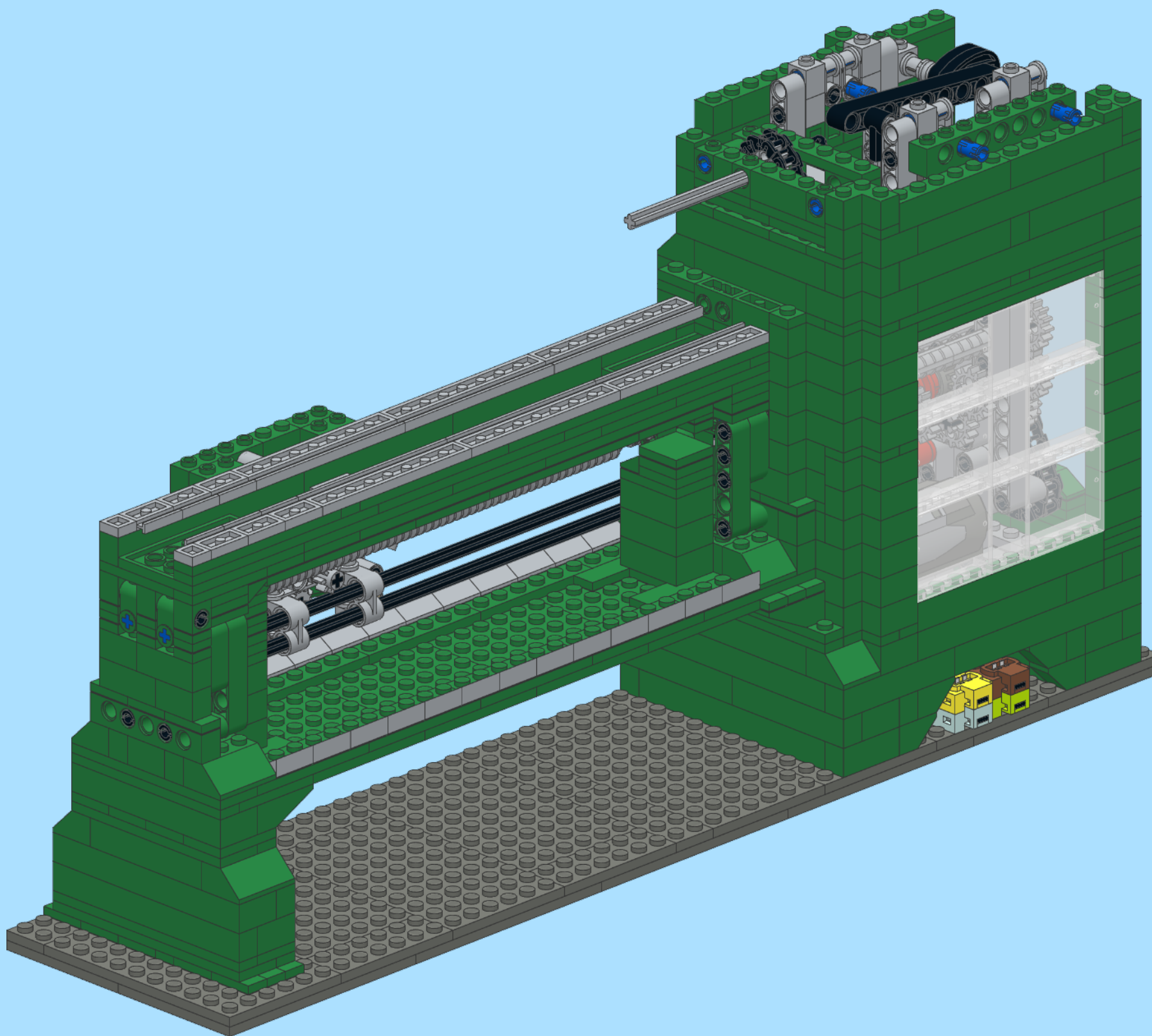
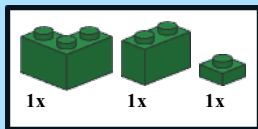

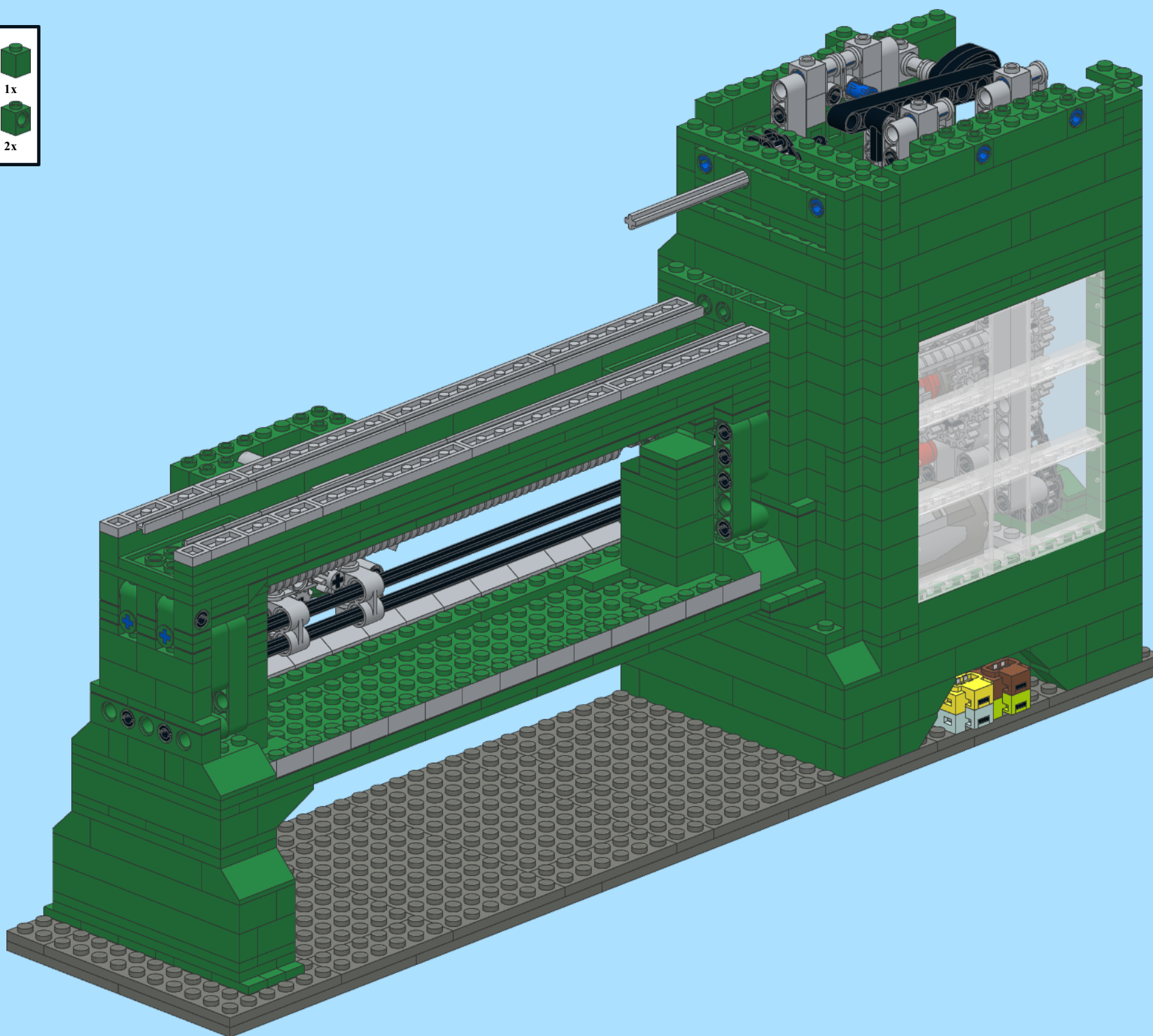
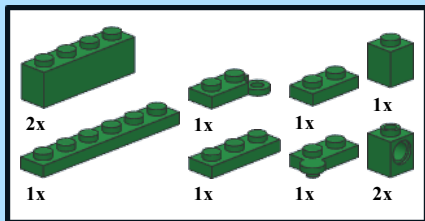

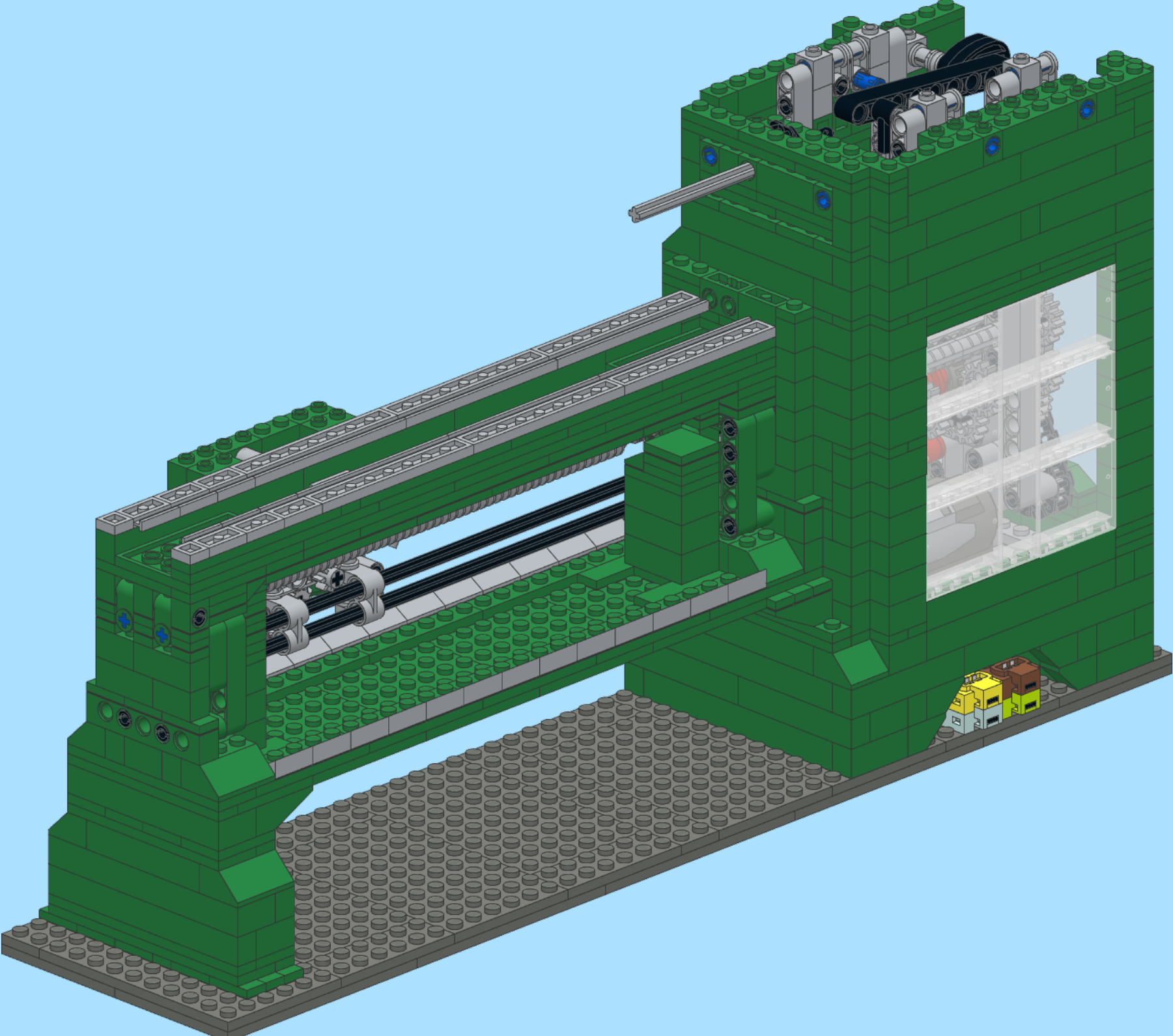
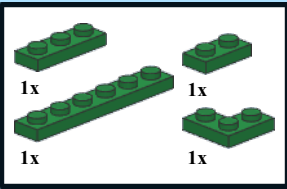





- 1x 
- 1x 
- 1x 
- 3x 