

DSB Litra MR-MRD

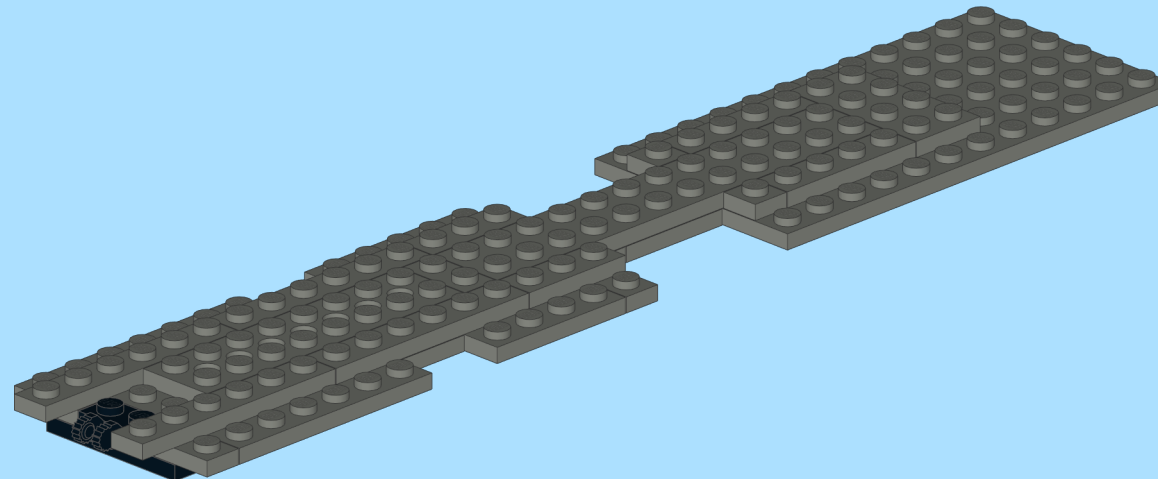

Designed by: Dennis Tomsen
At: Byggepladen
Update: 2018-11-27

INSTRUCTION BY
KNUD ALBRECHTSEN
www.snakebyte.dk/lego

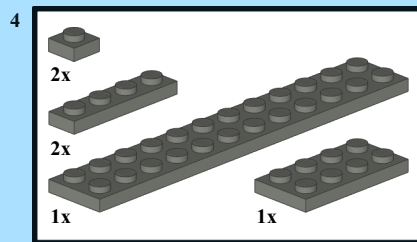
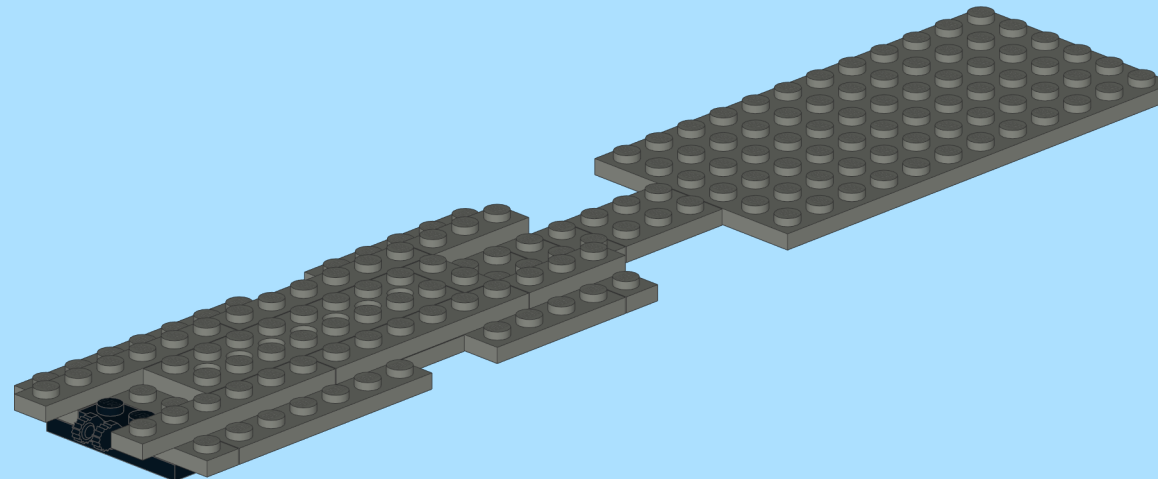
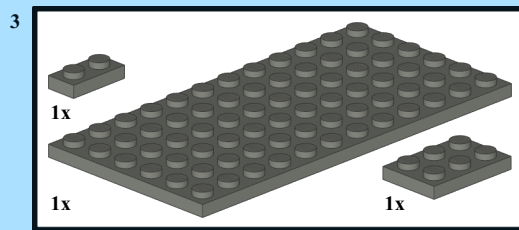
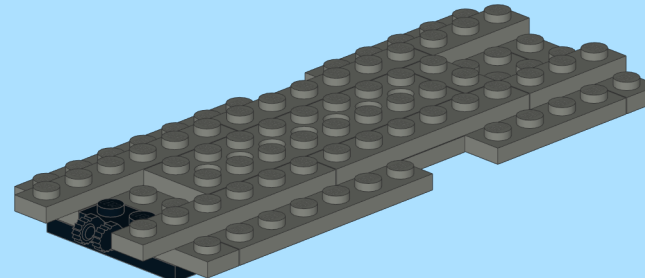
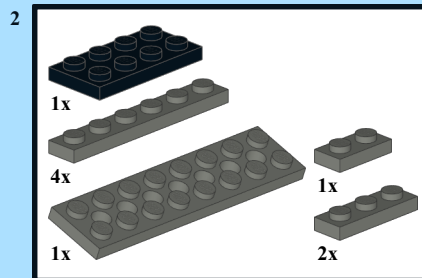
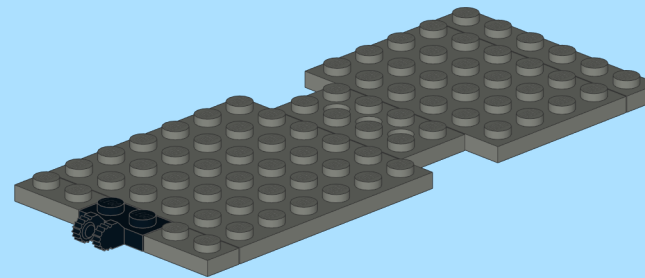
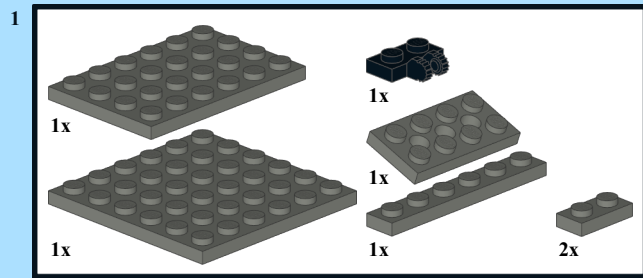

5

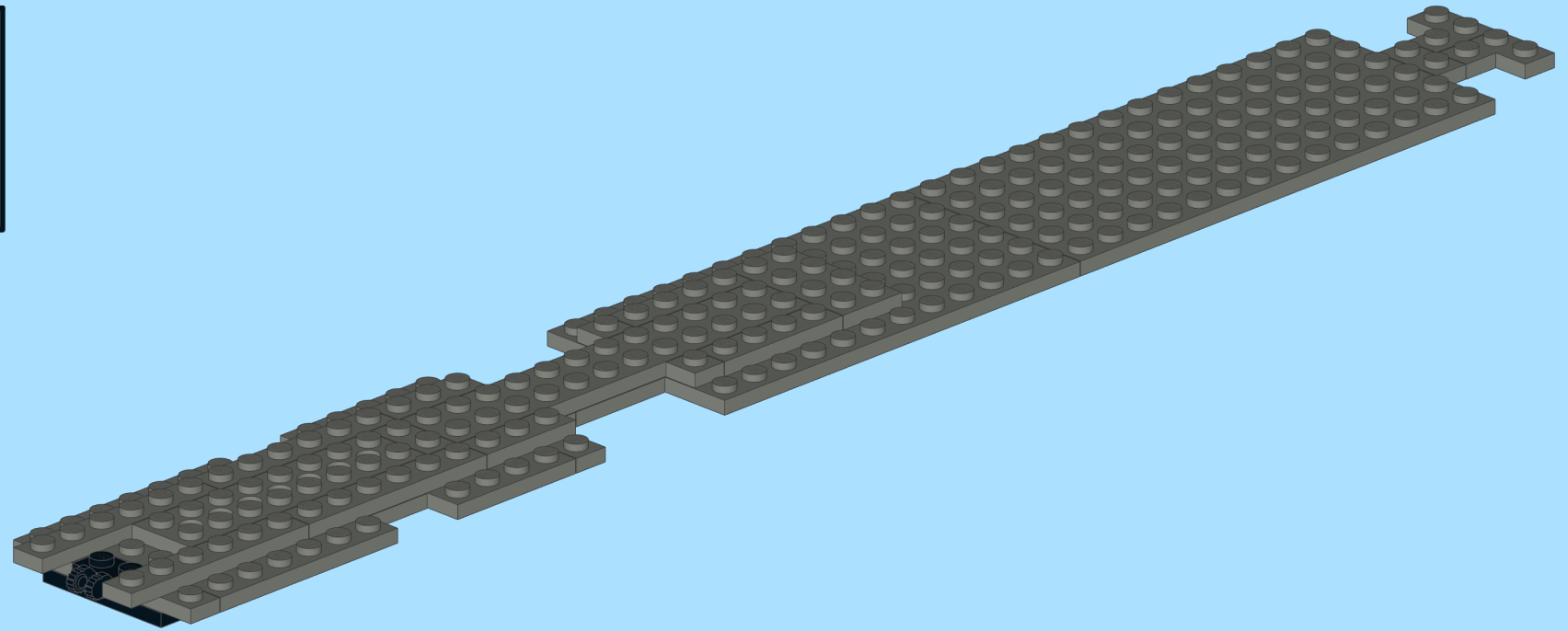
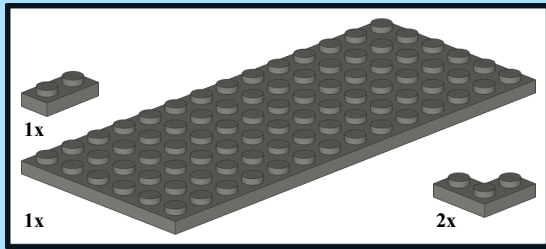

6

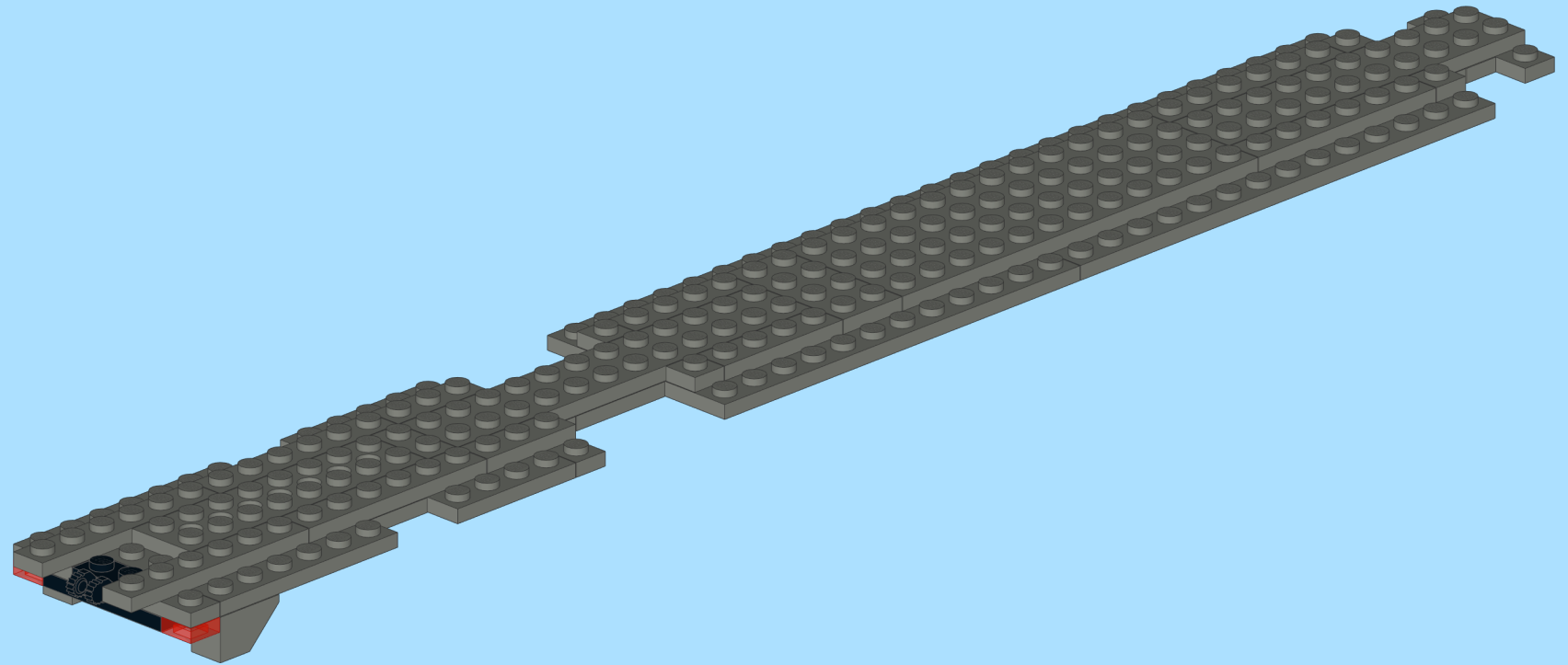
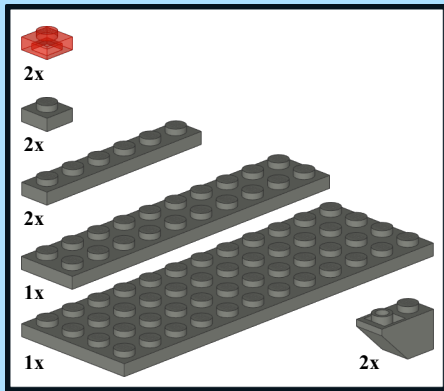

7

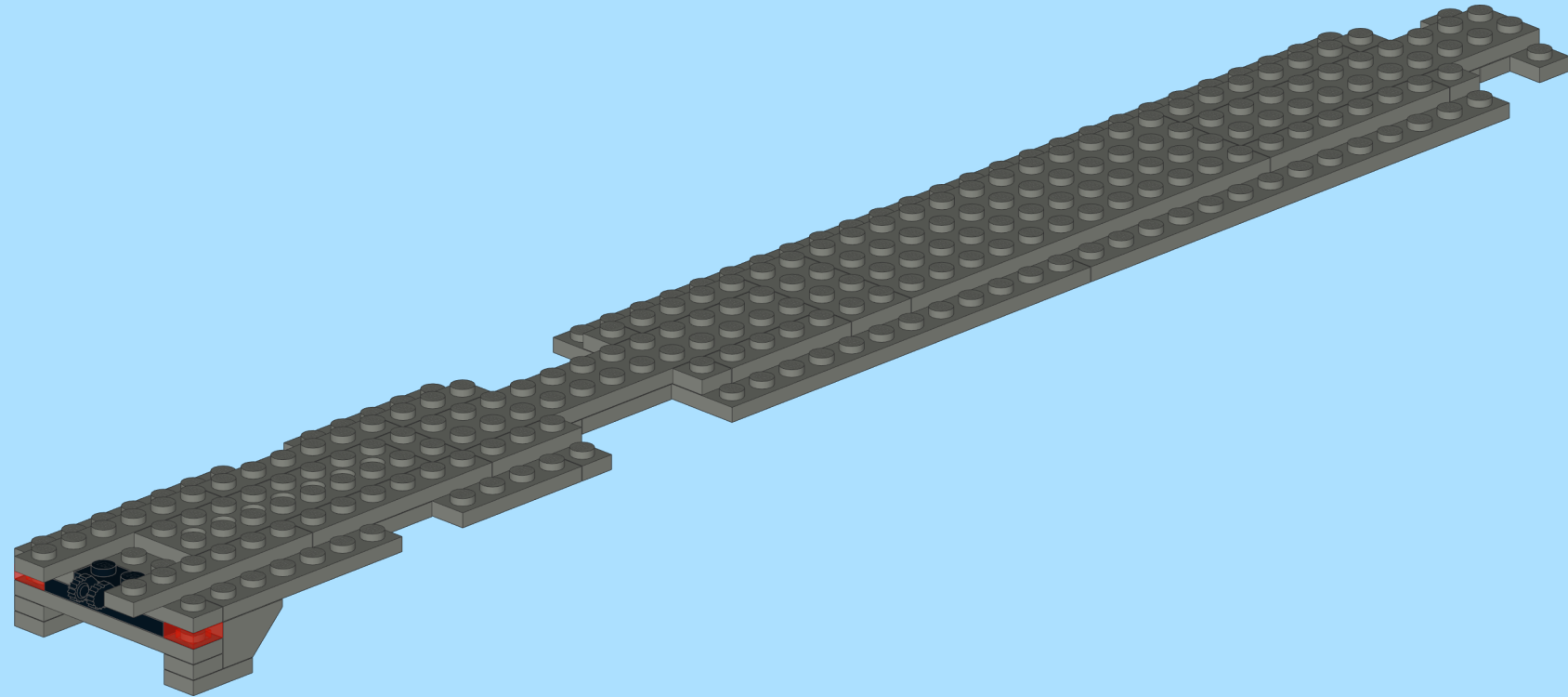
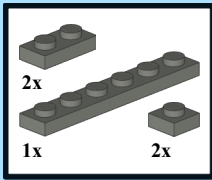

8

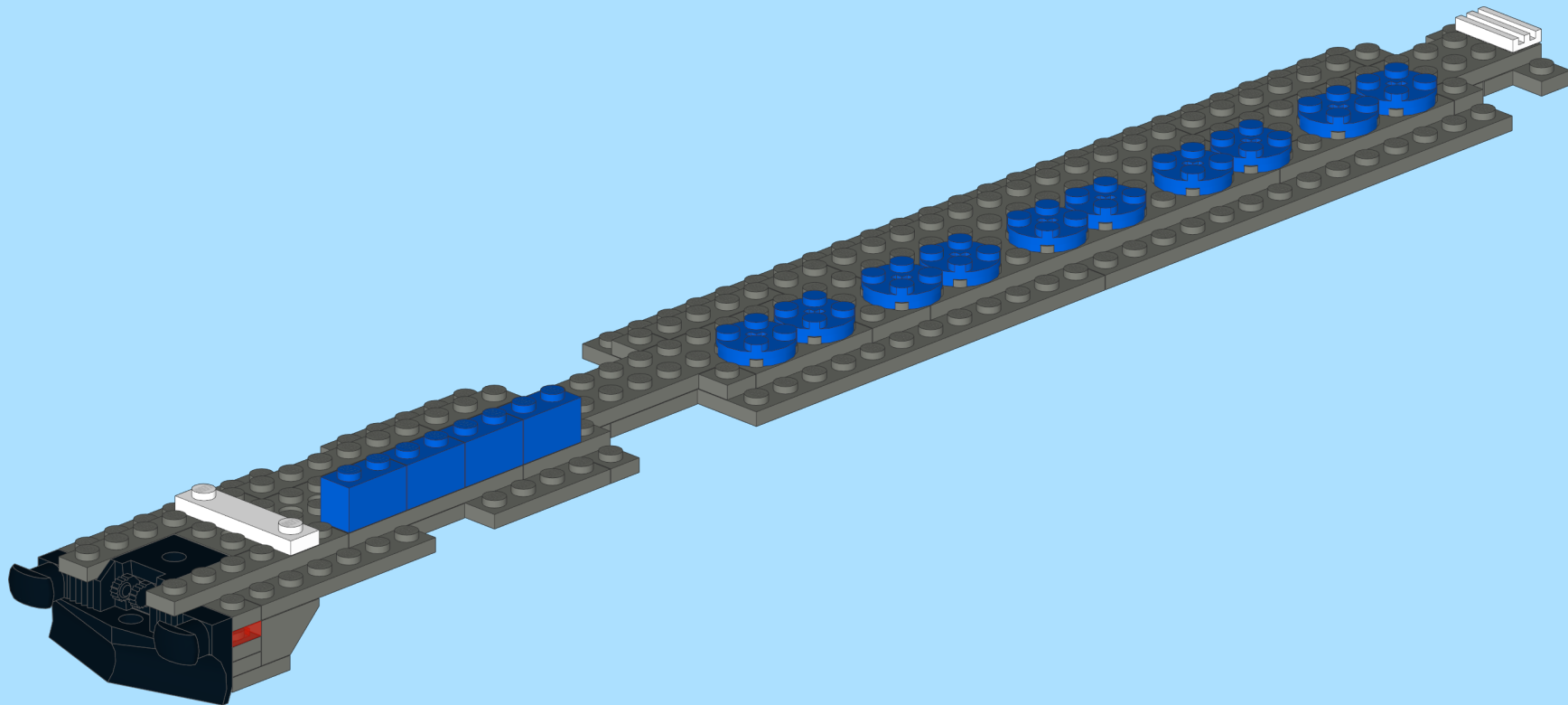
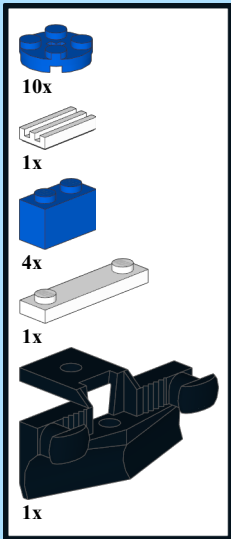

9

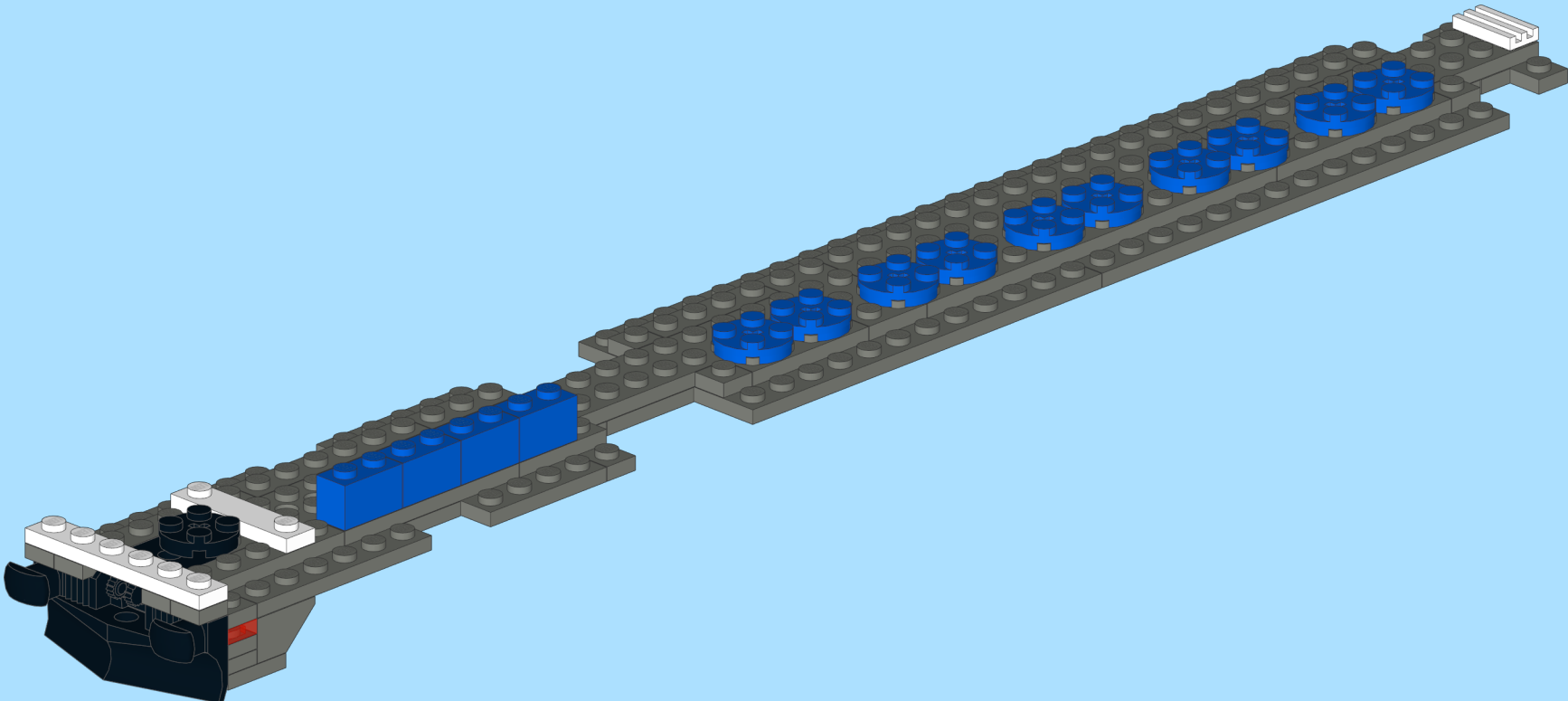
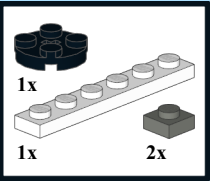

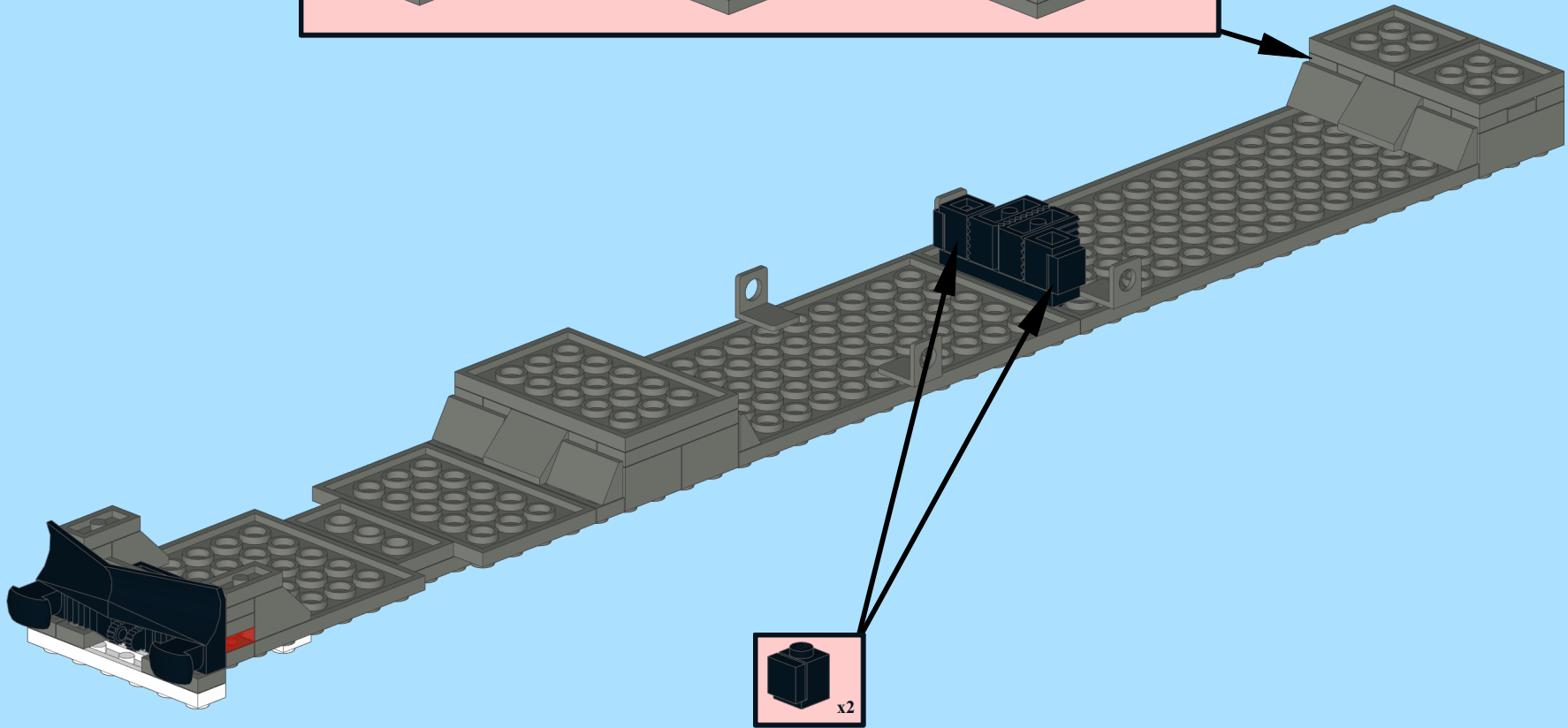
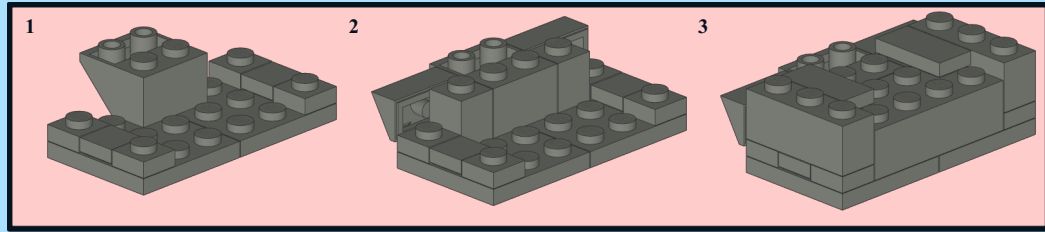
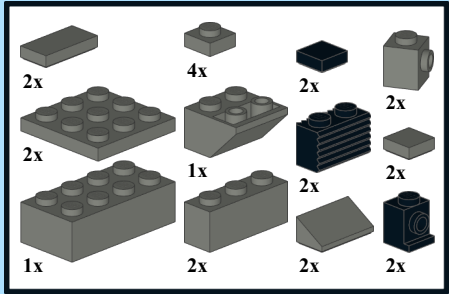

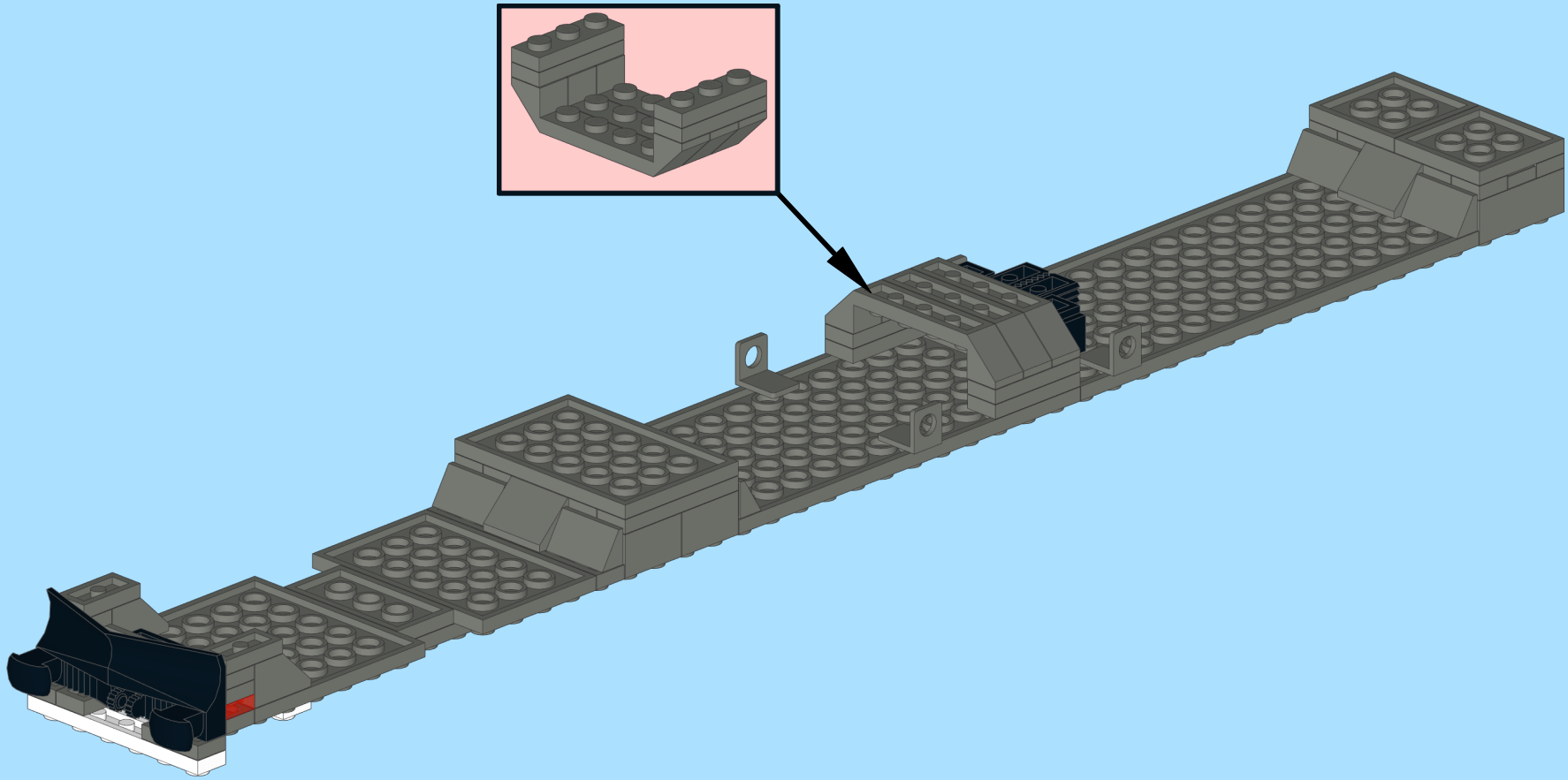
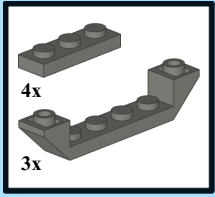

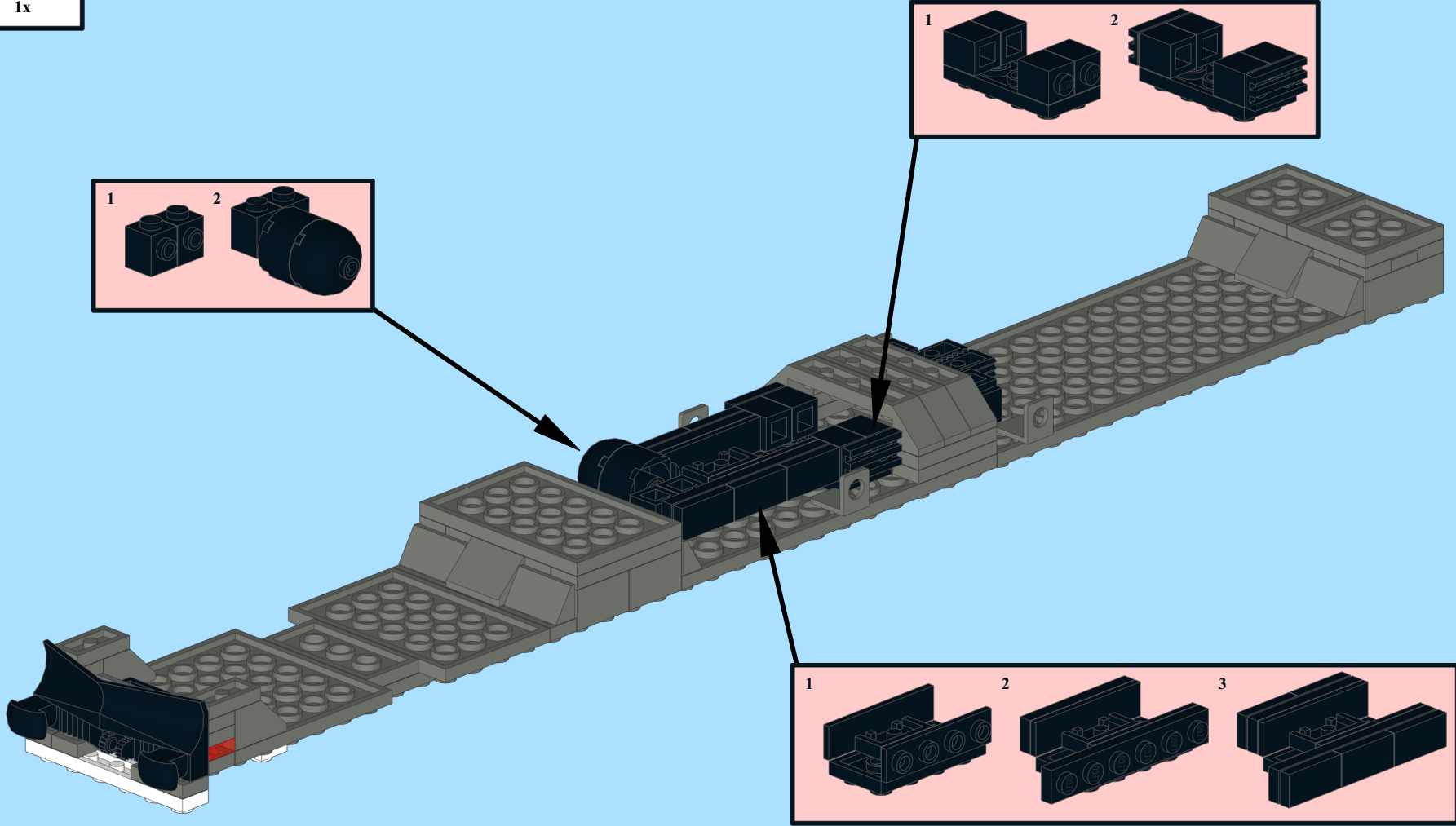
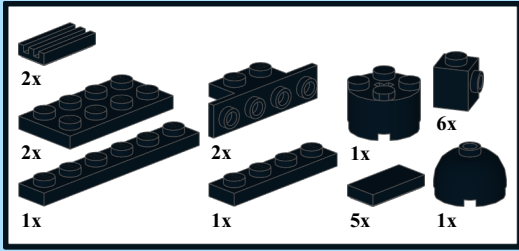

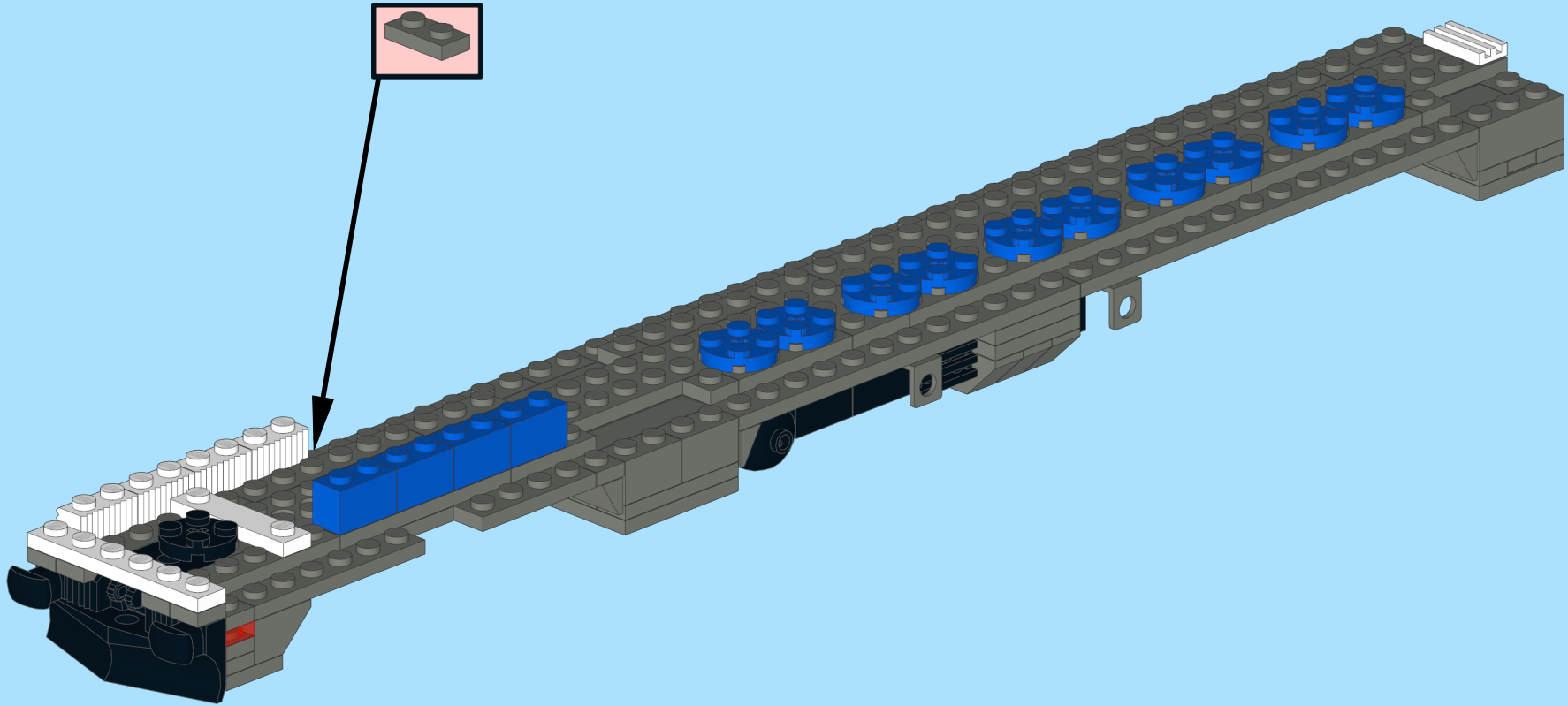
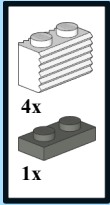

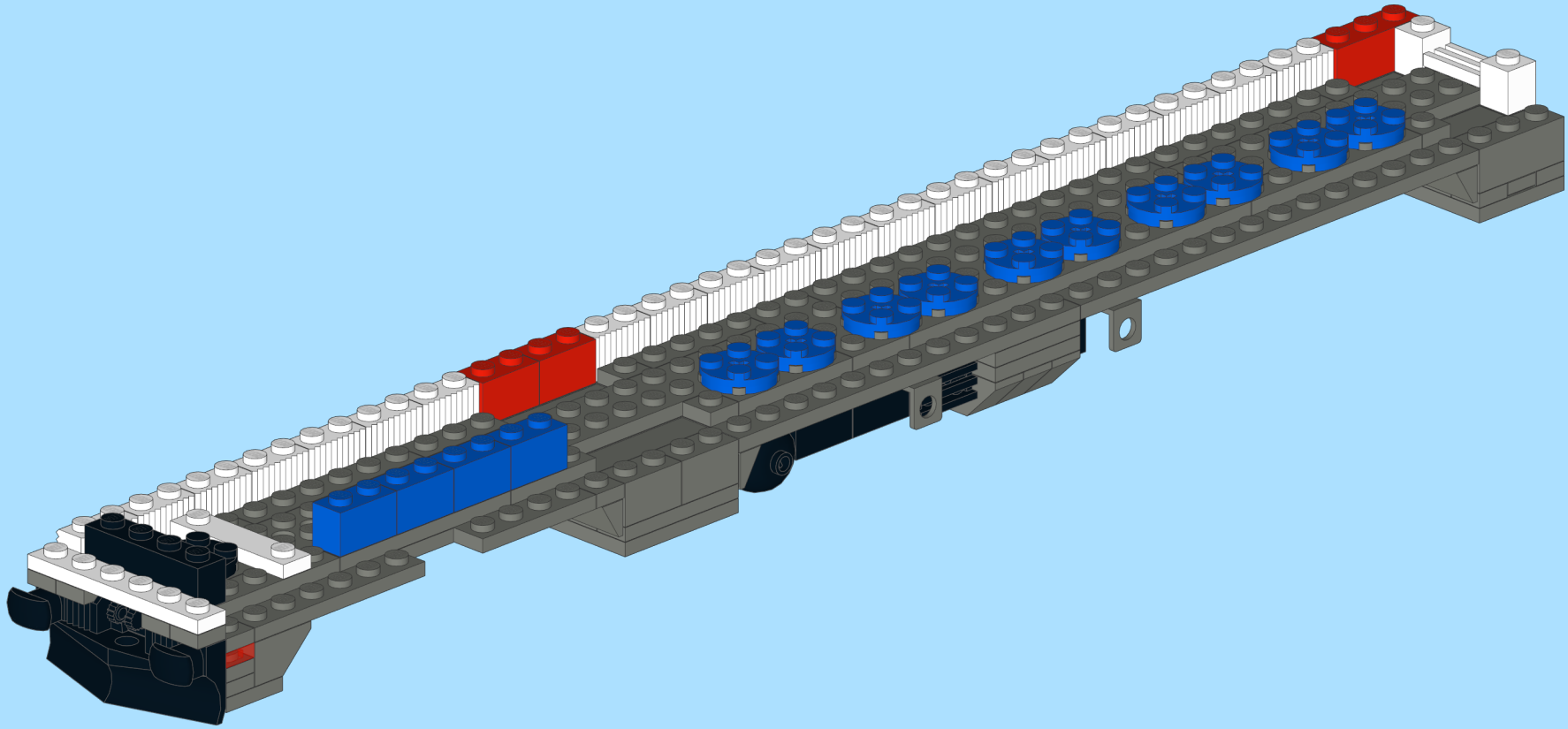
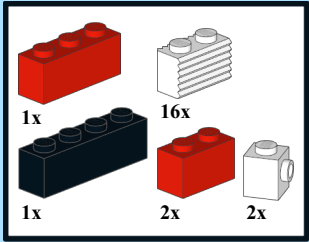

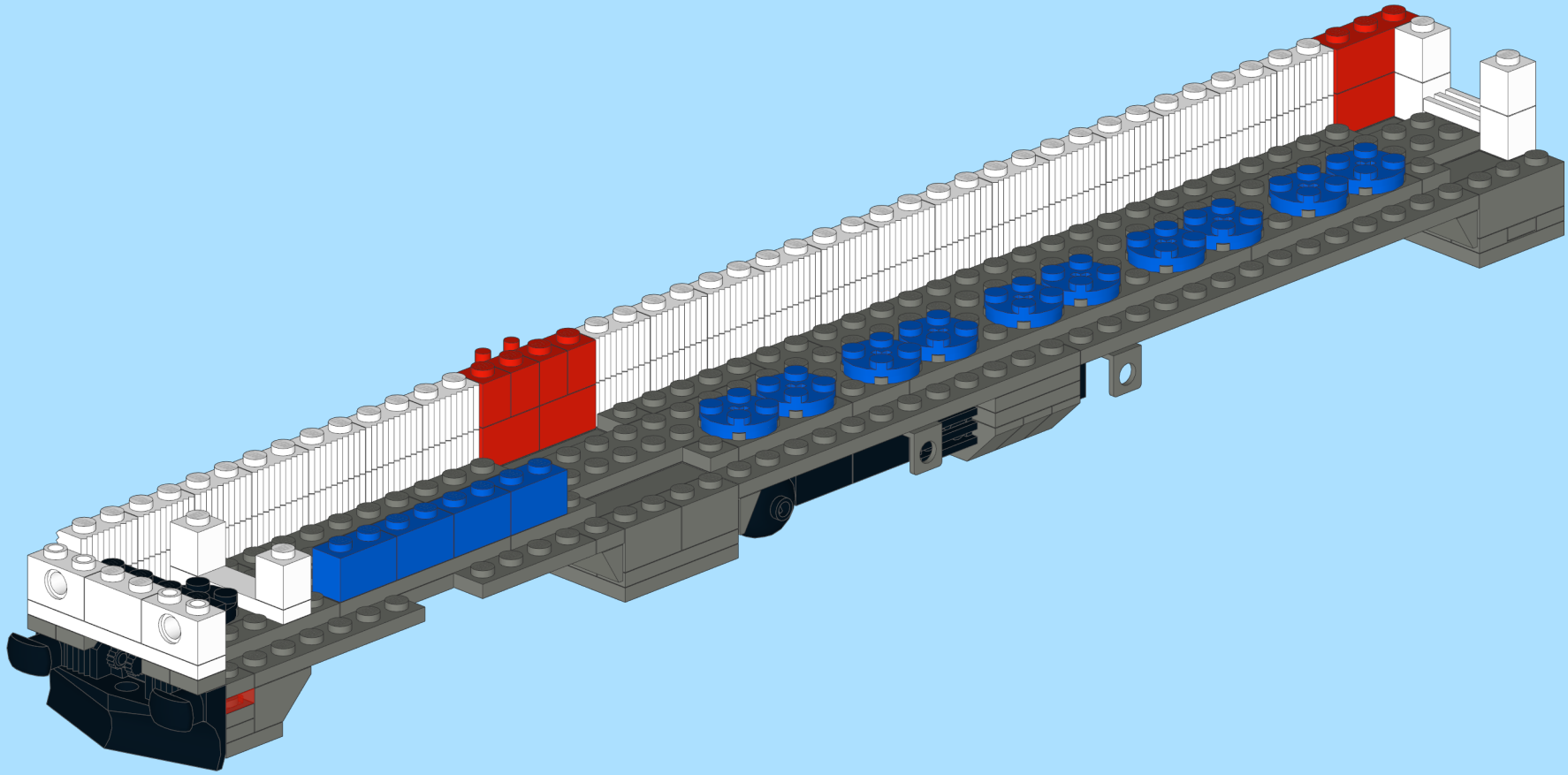
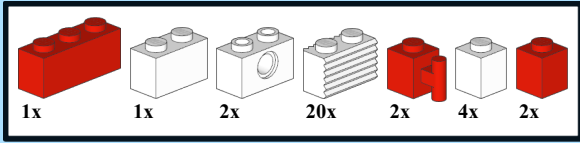

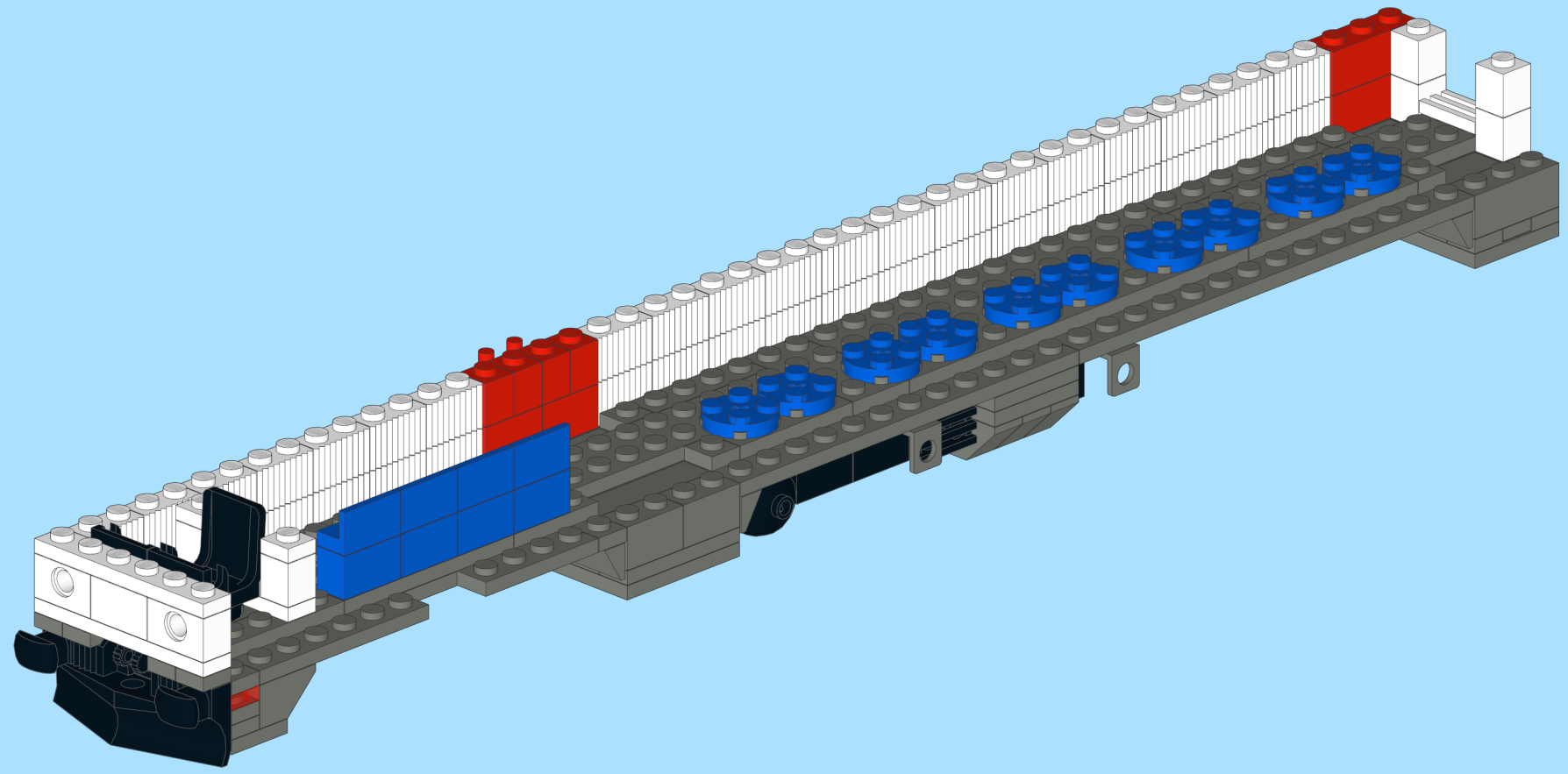
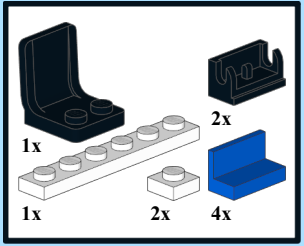

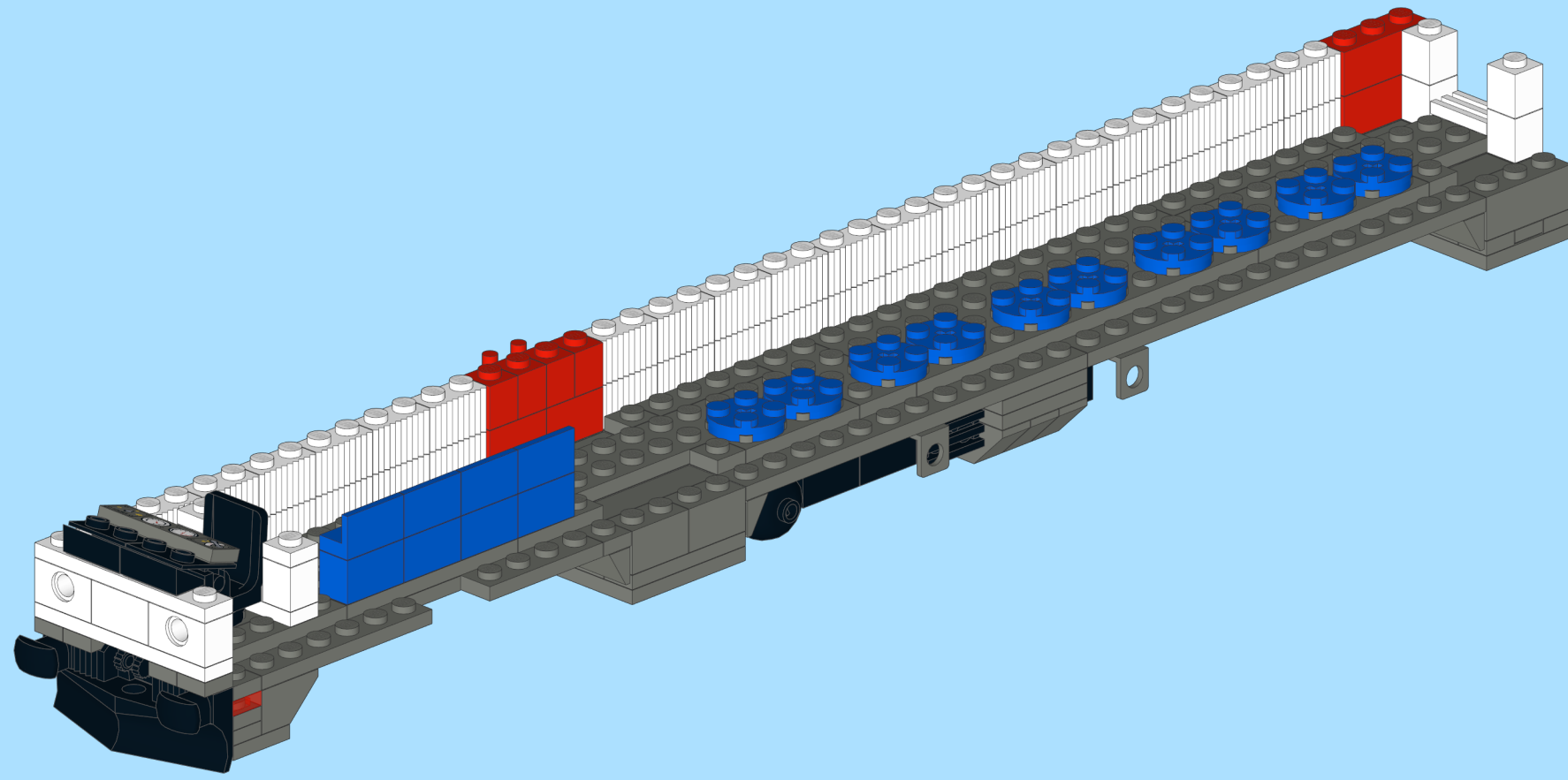
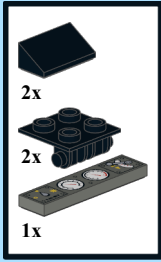

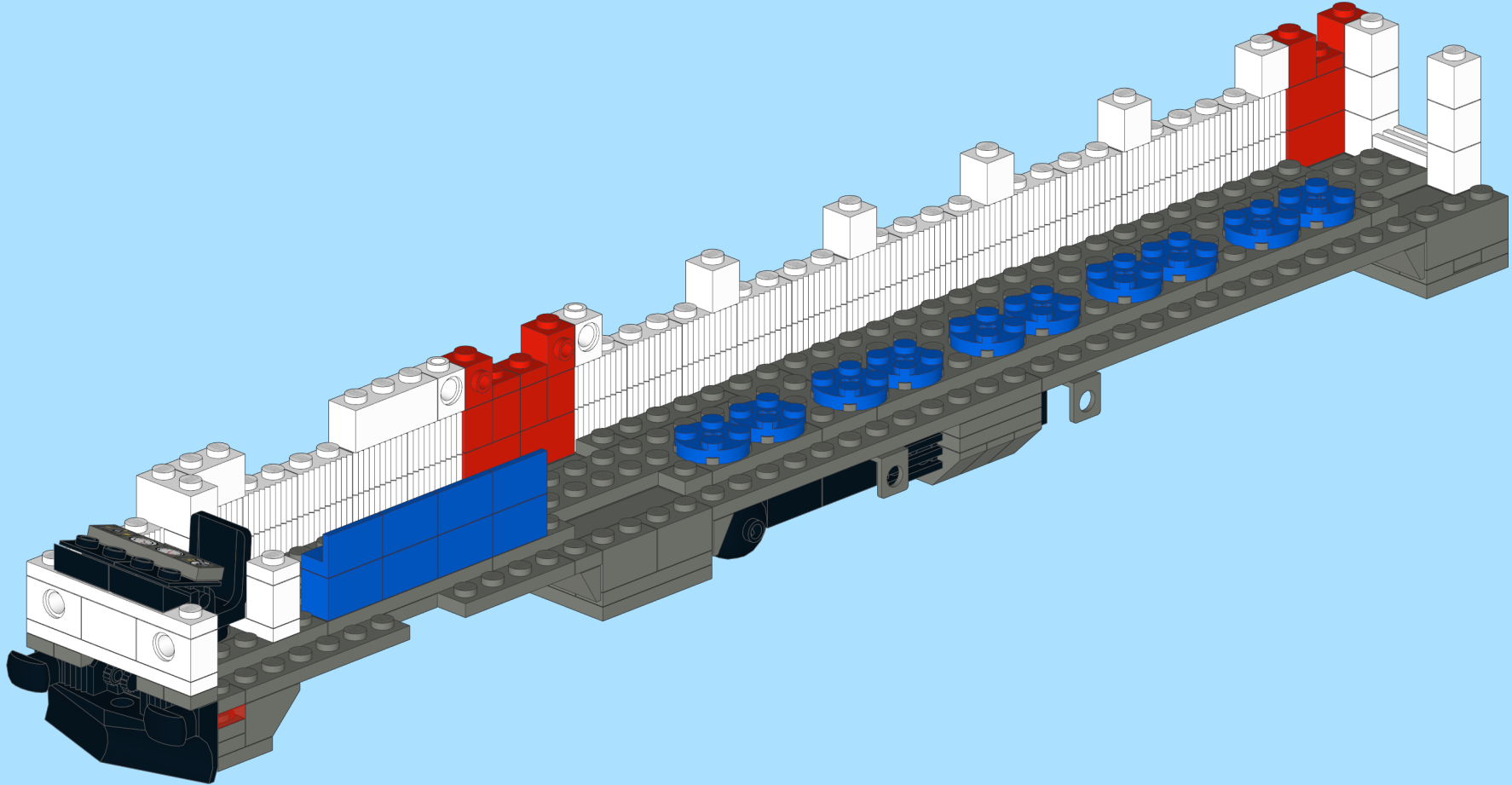
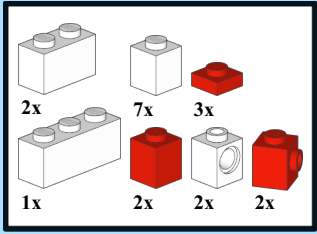

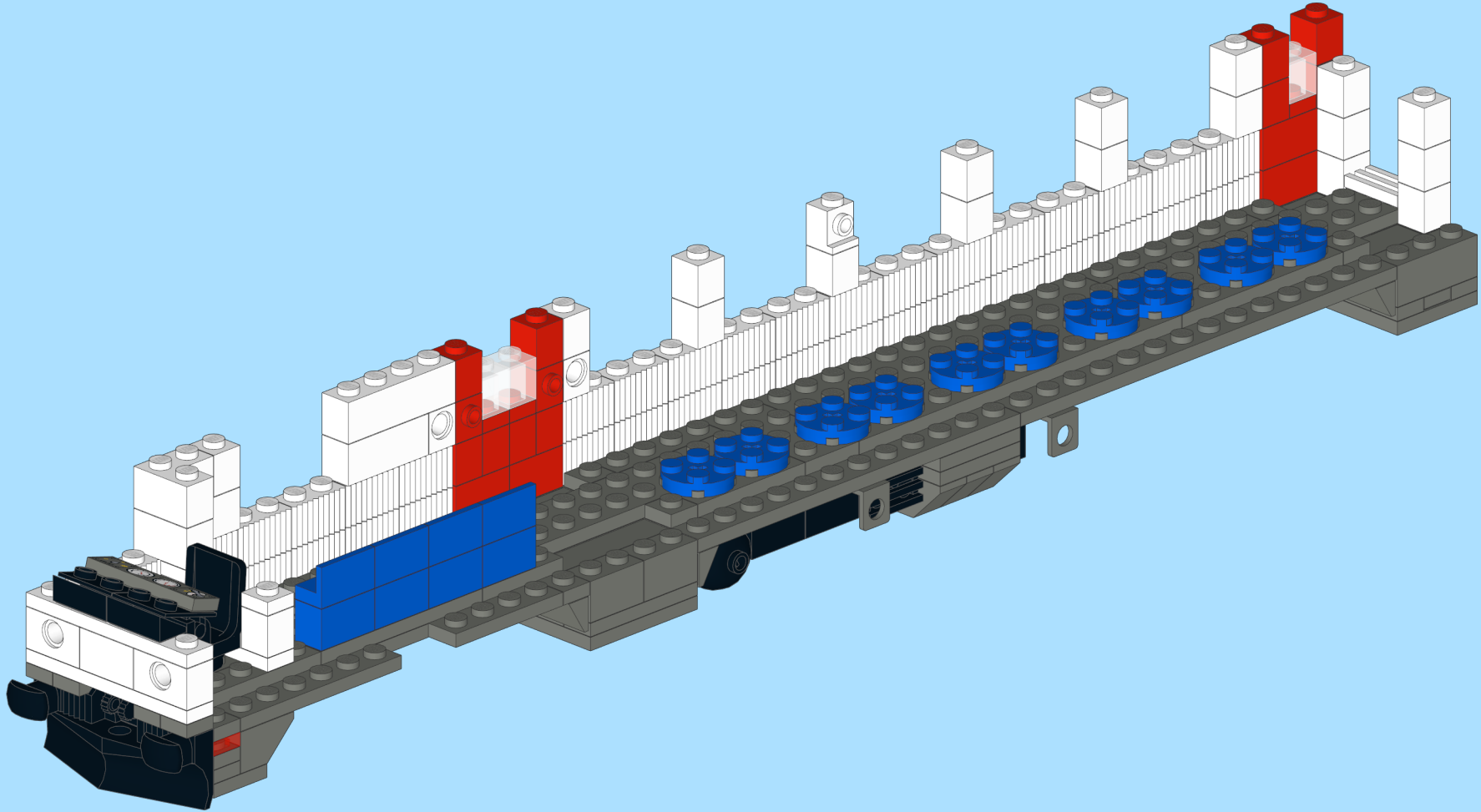
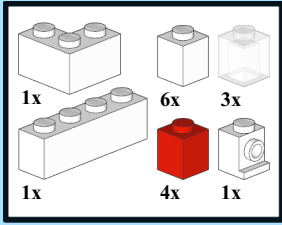

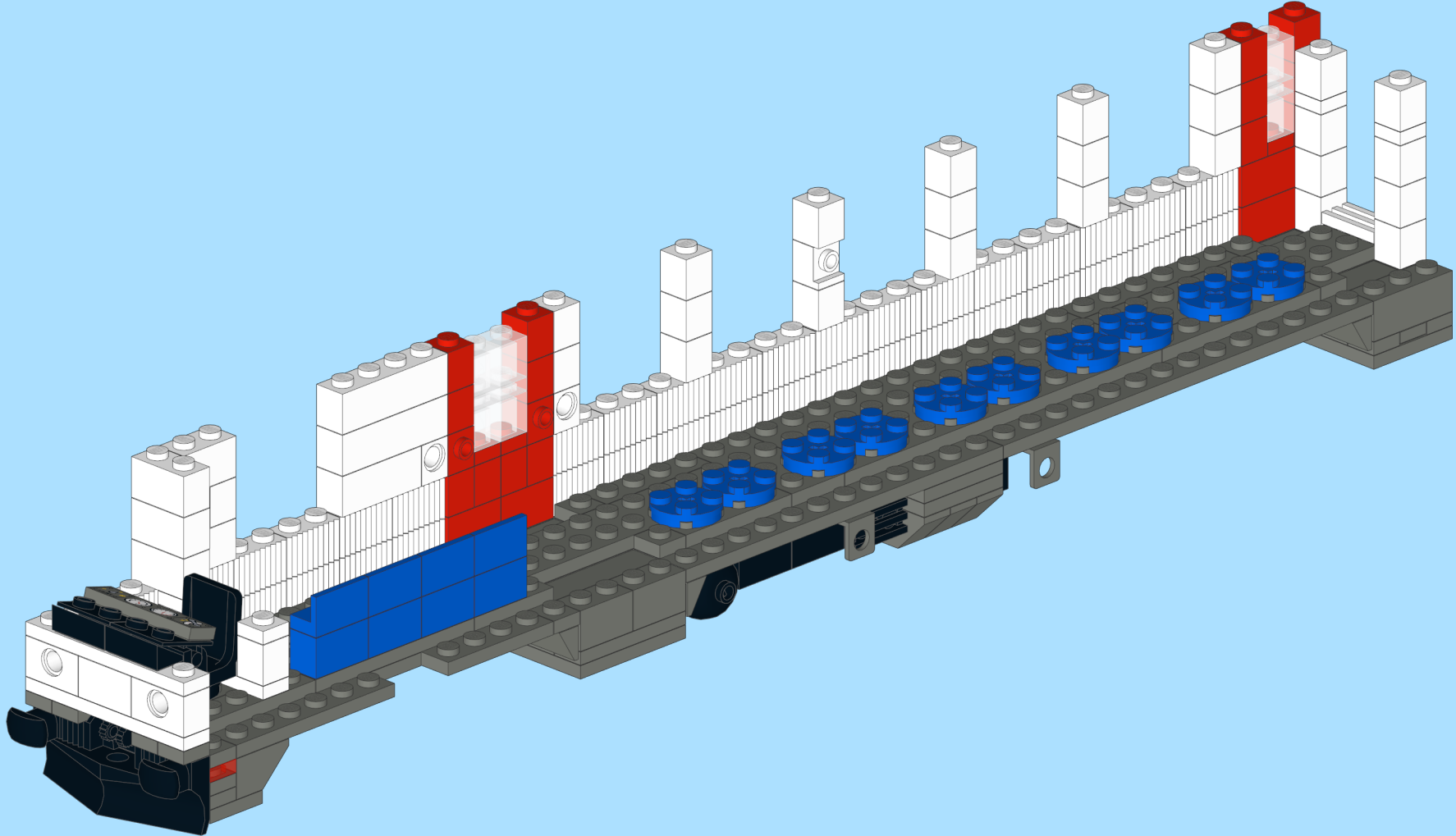
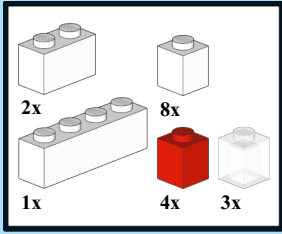

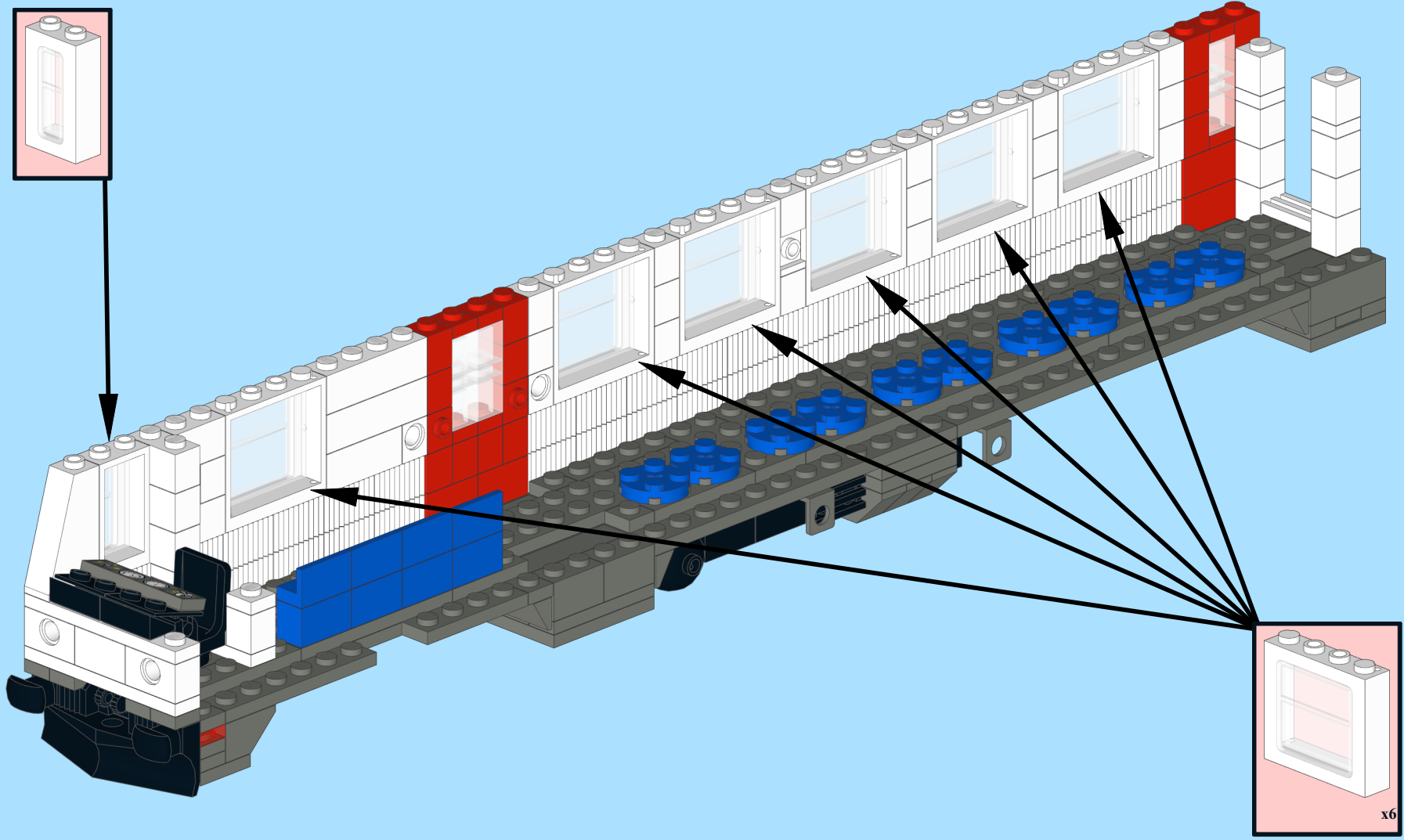
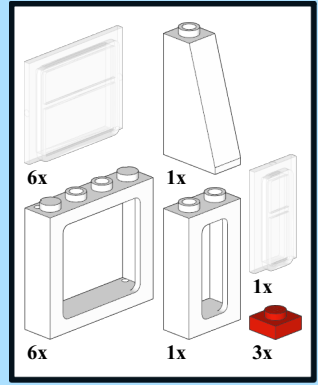

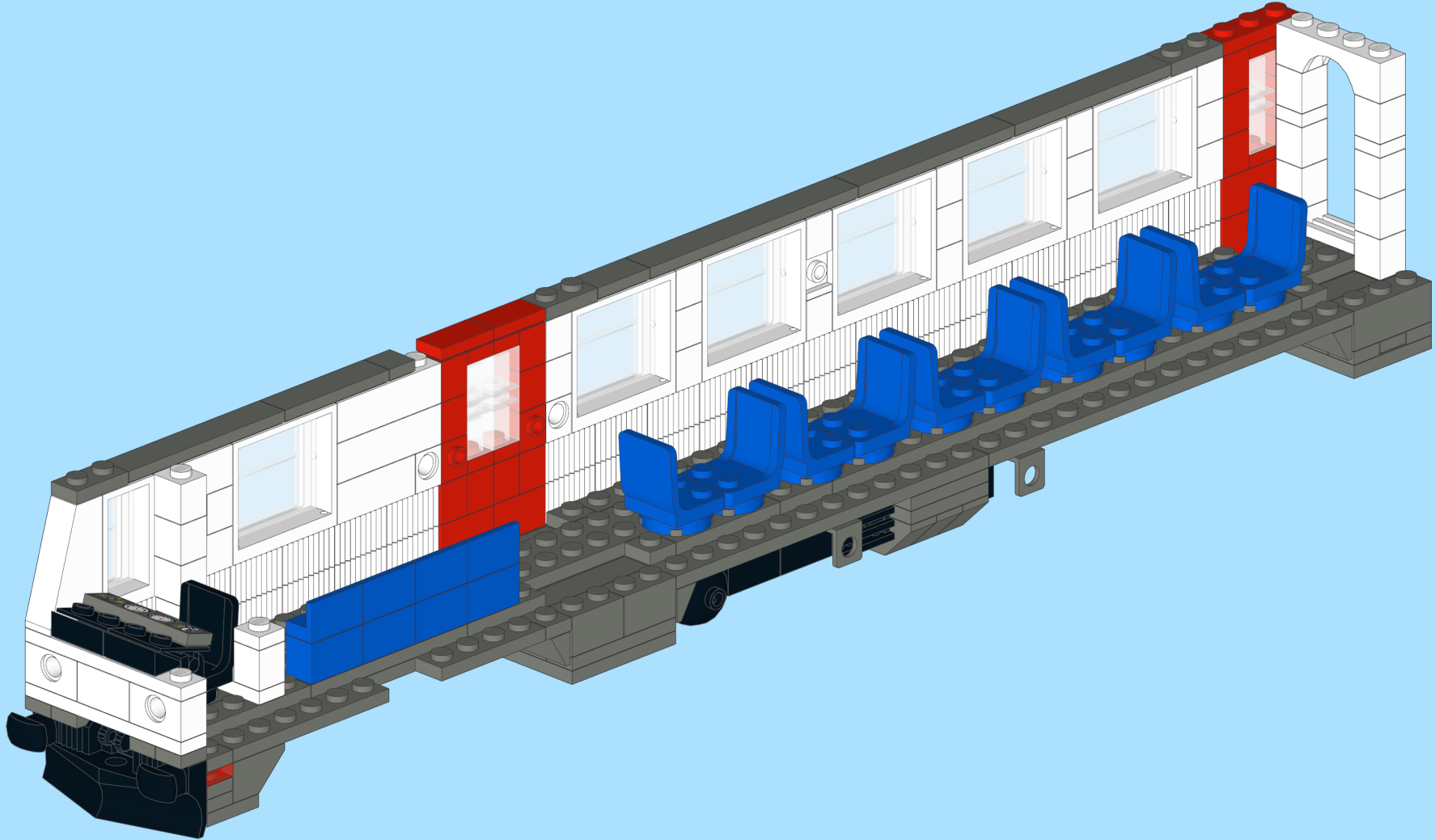
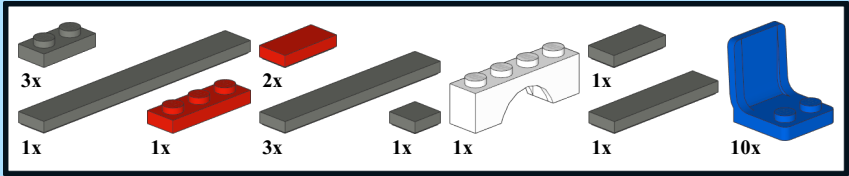

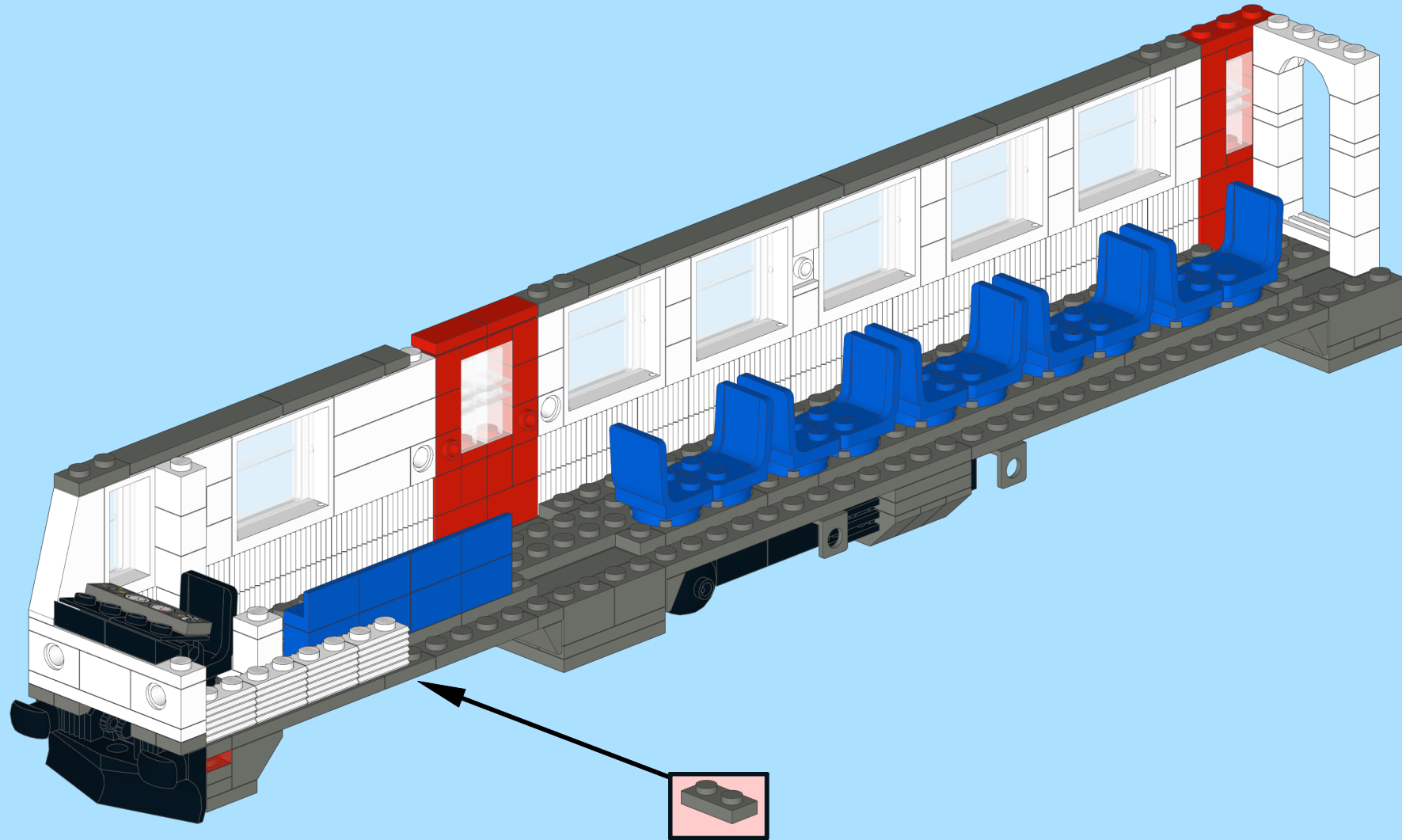
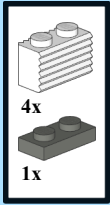

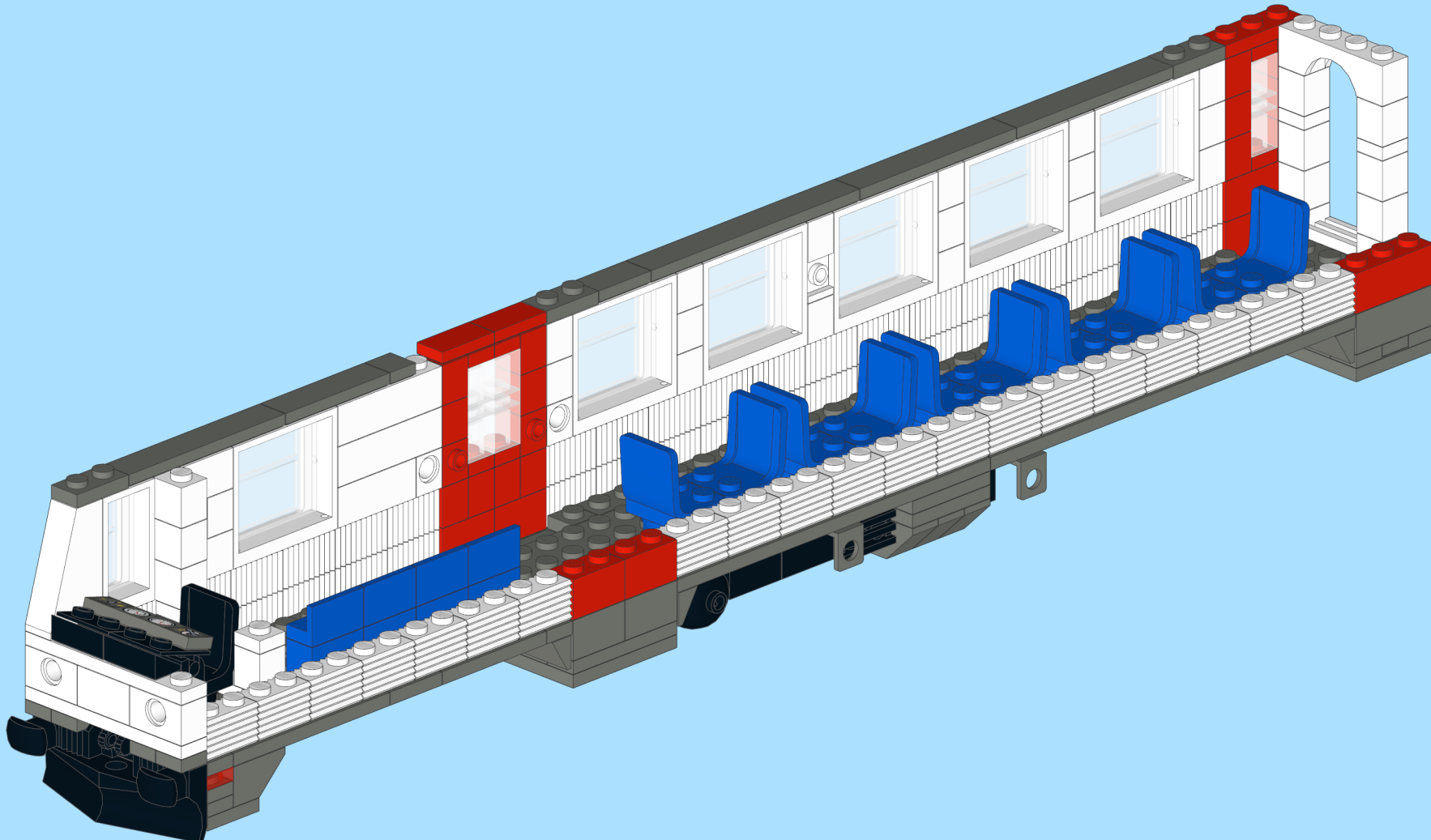
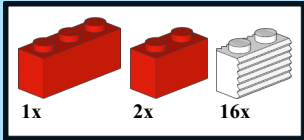

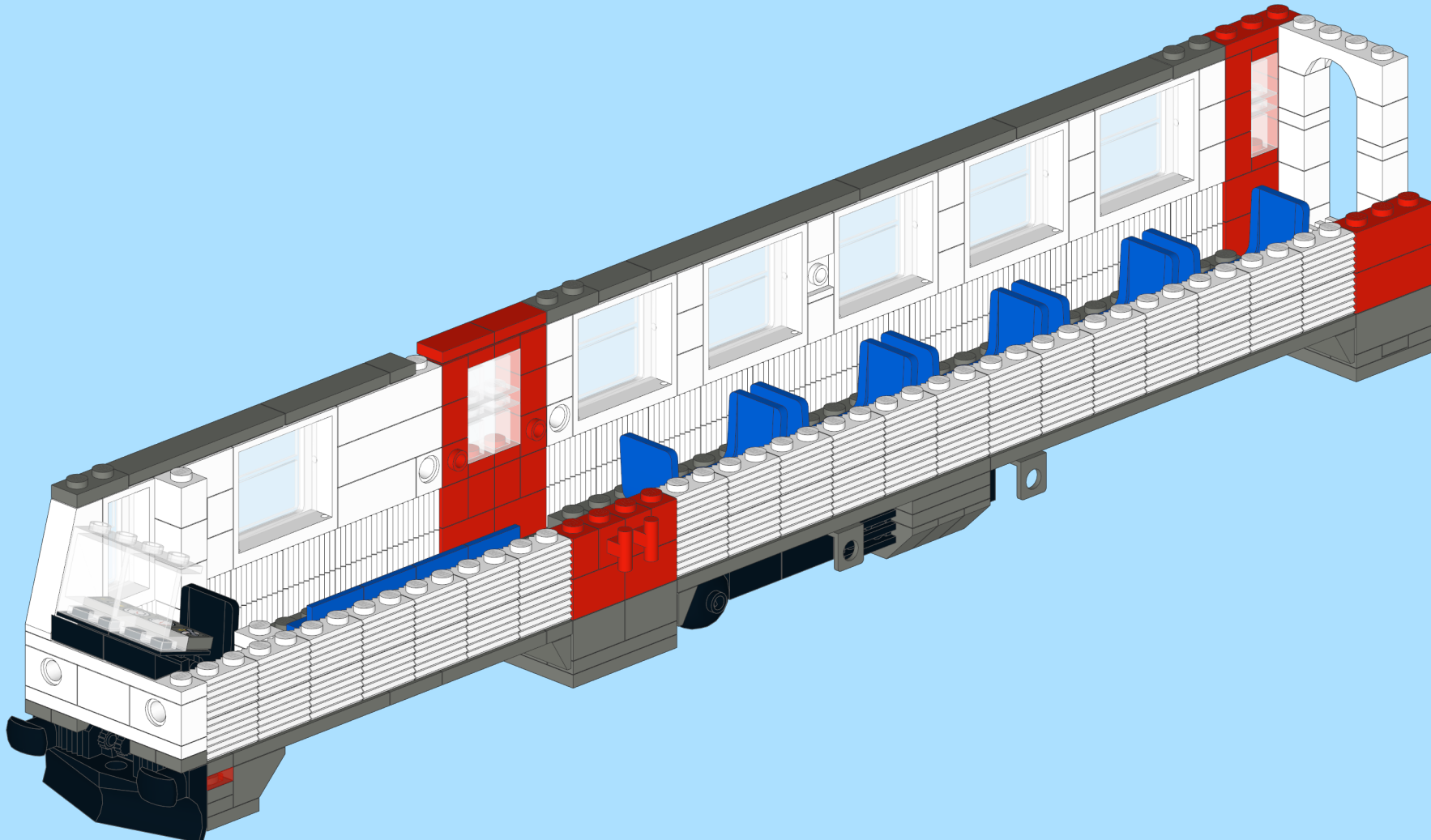
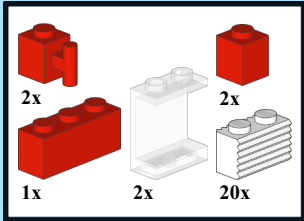

2x	3x	2x
2x	5x	2x
1x	2x	2x

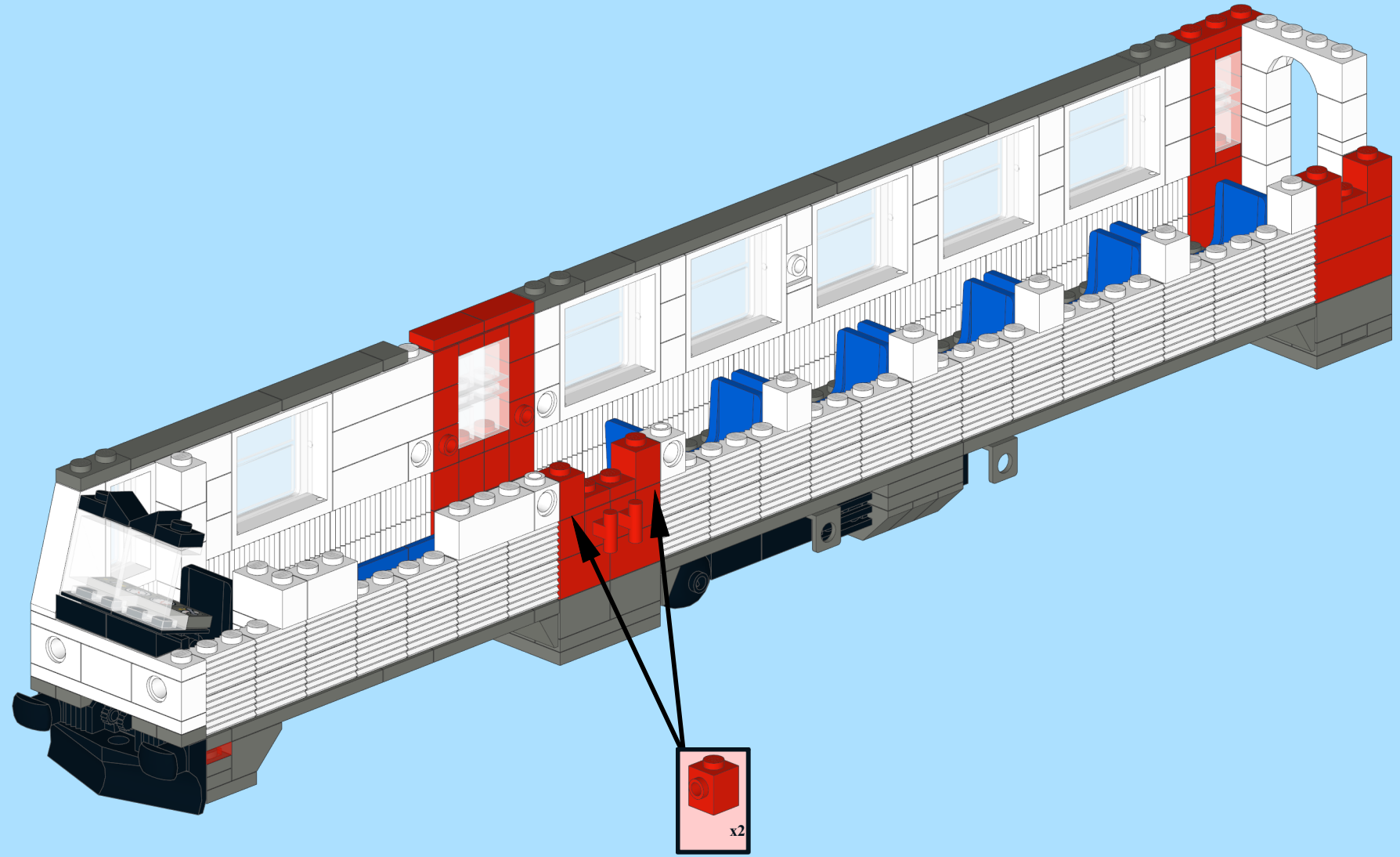

x2

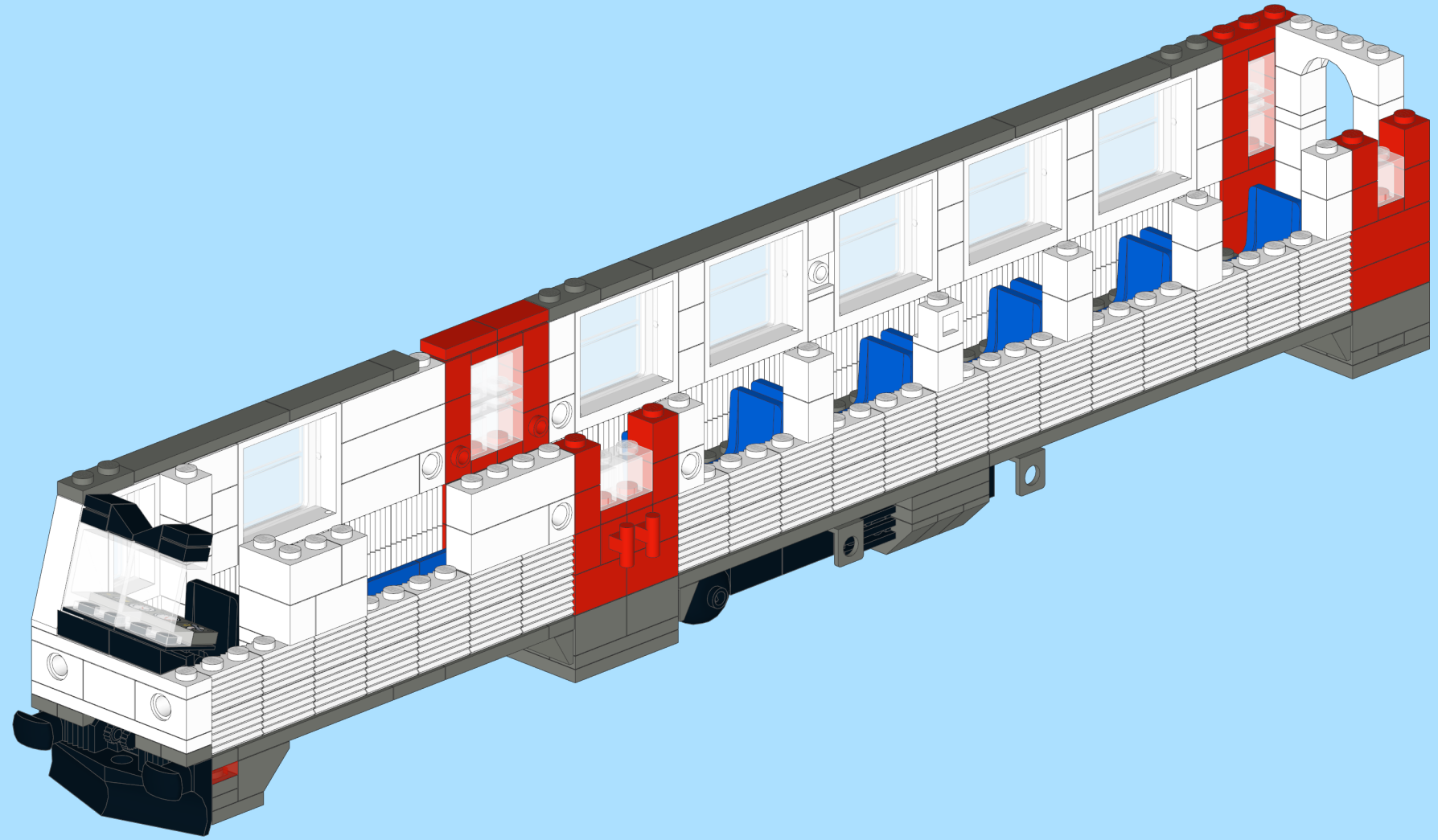
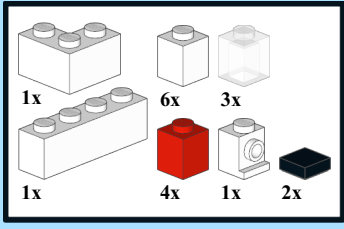

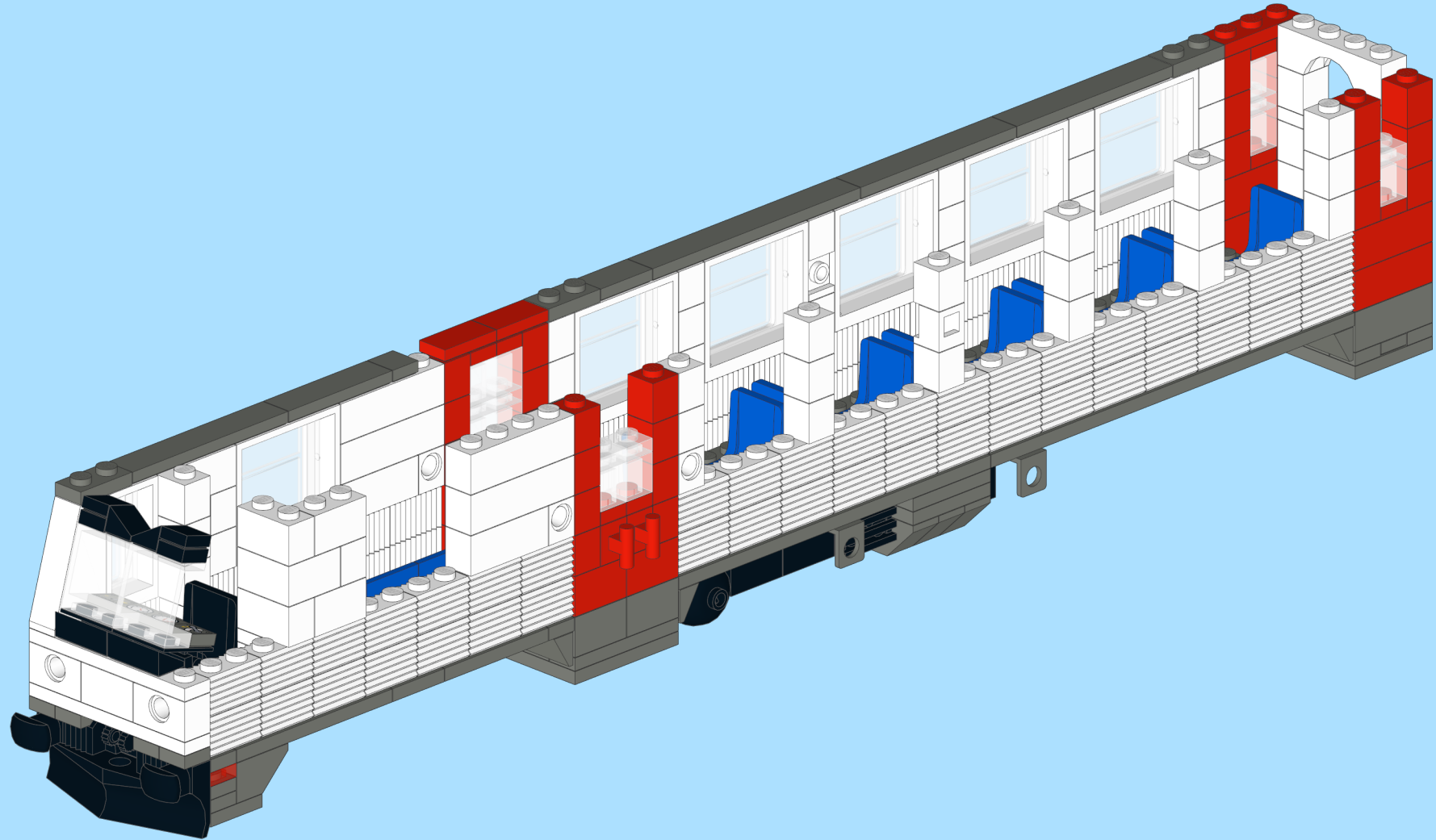
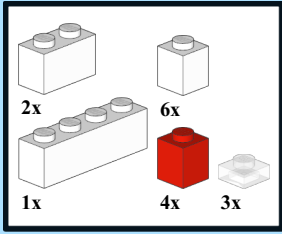

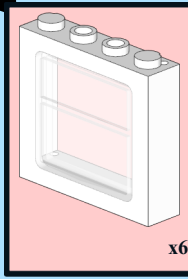
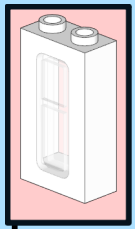
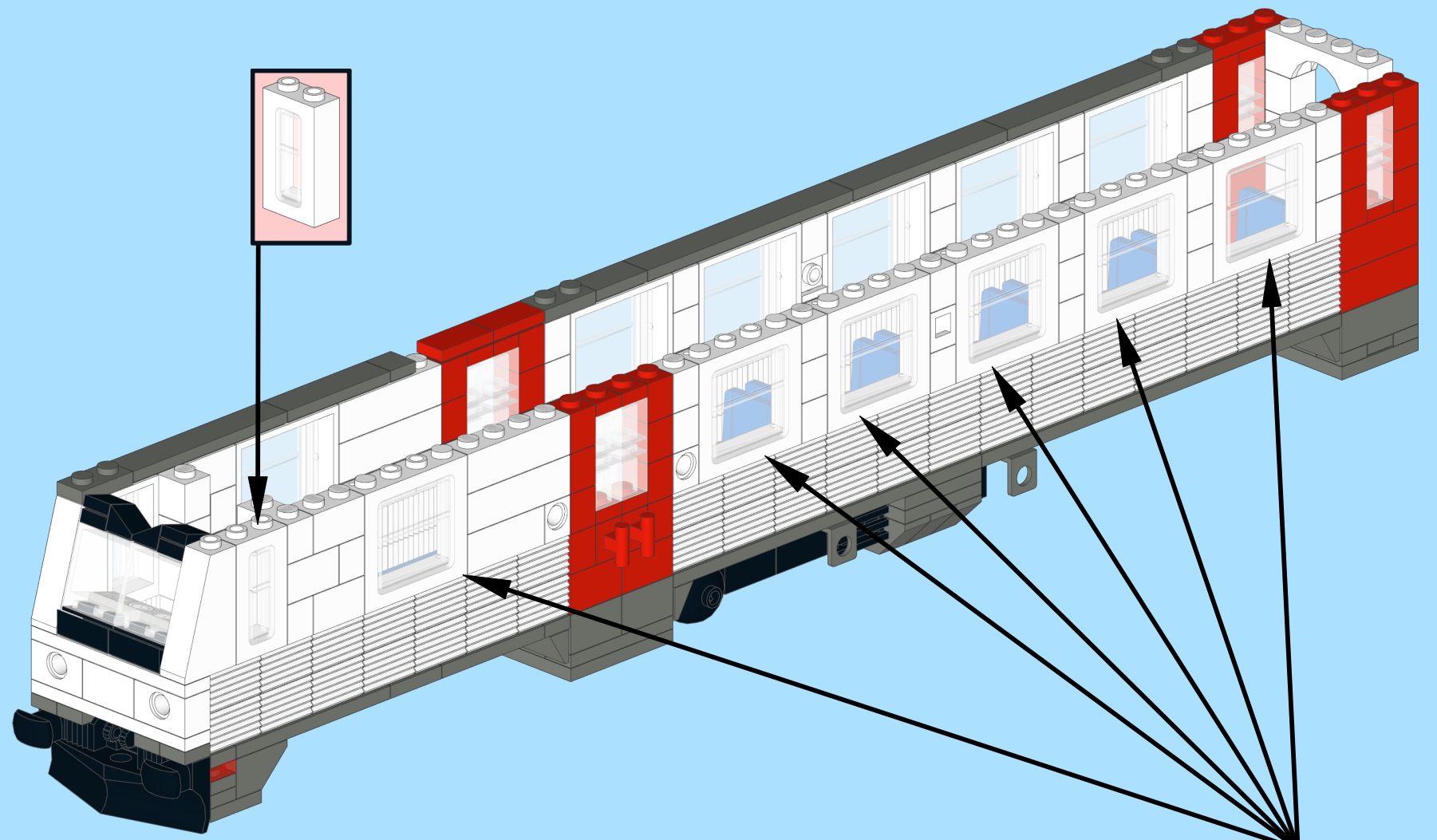
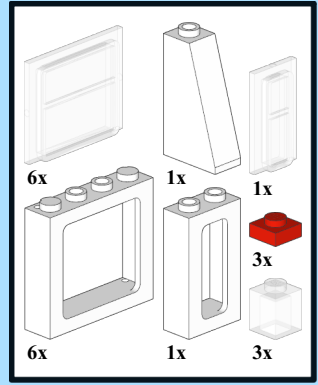

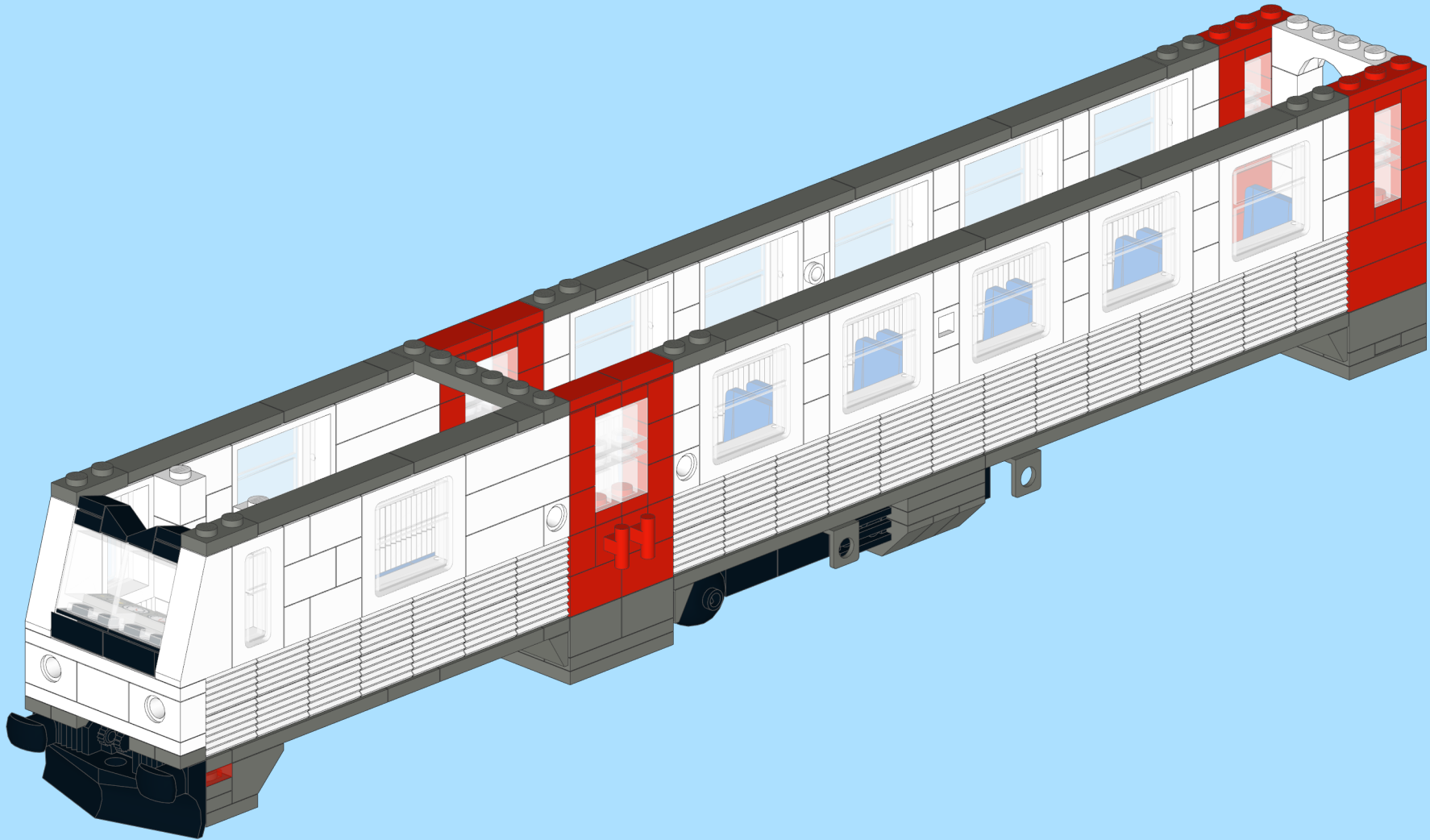
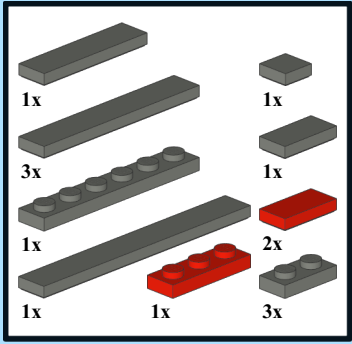

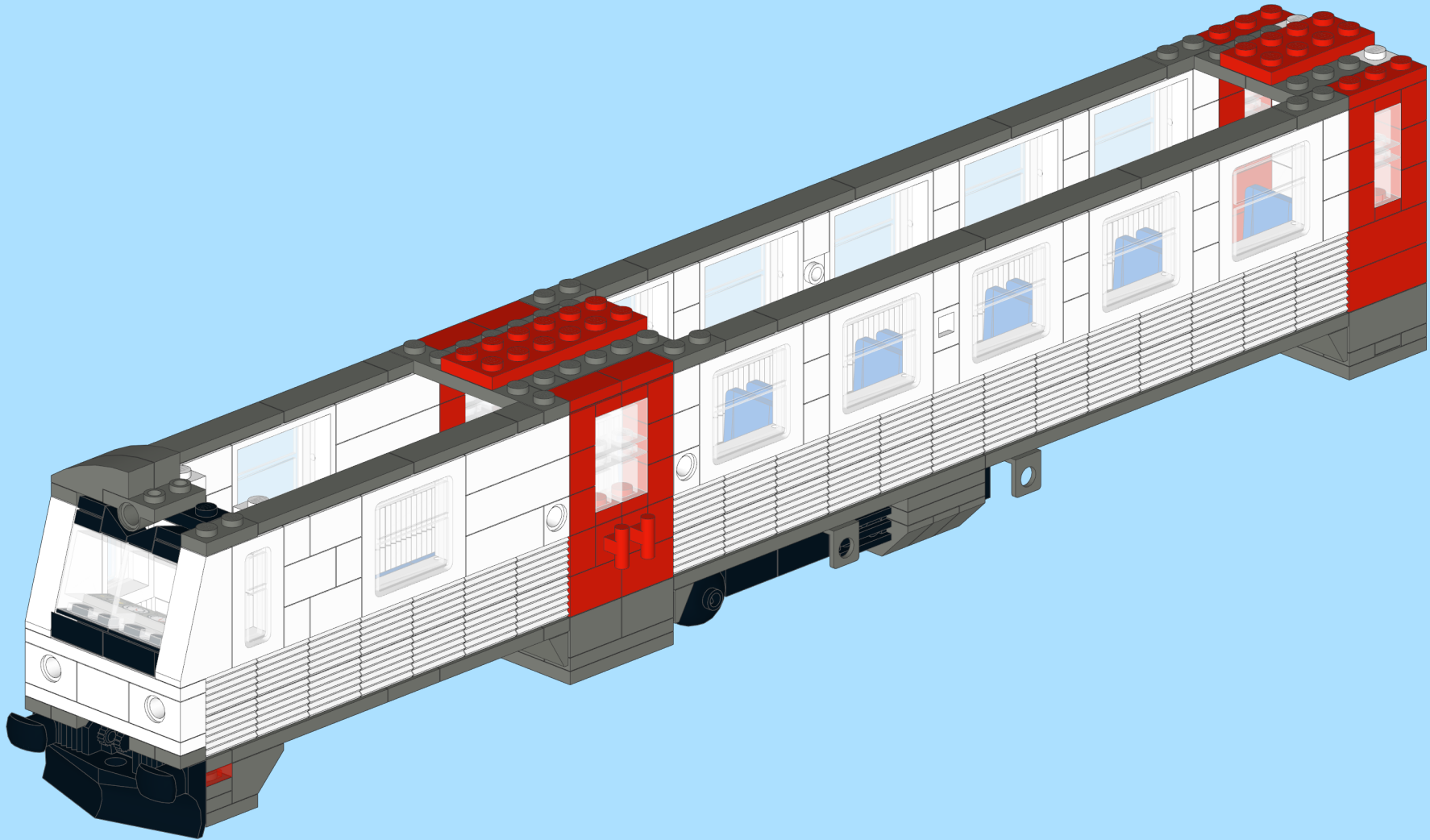
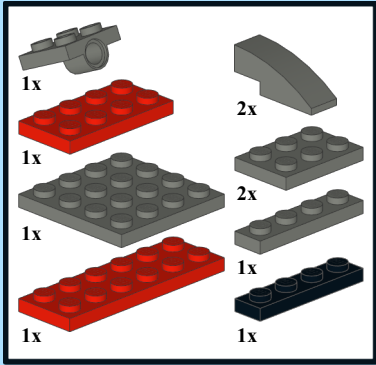

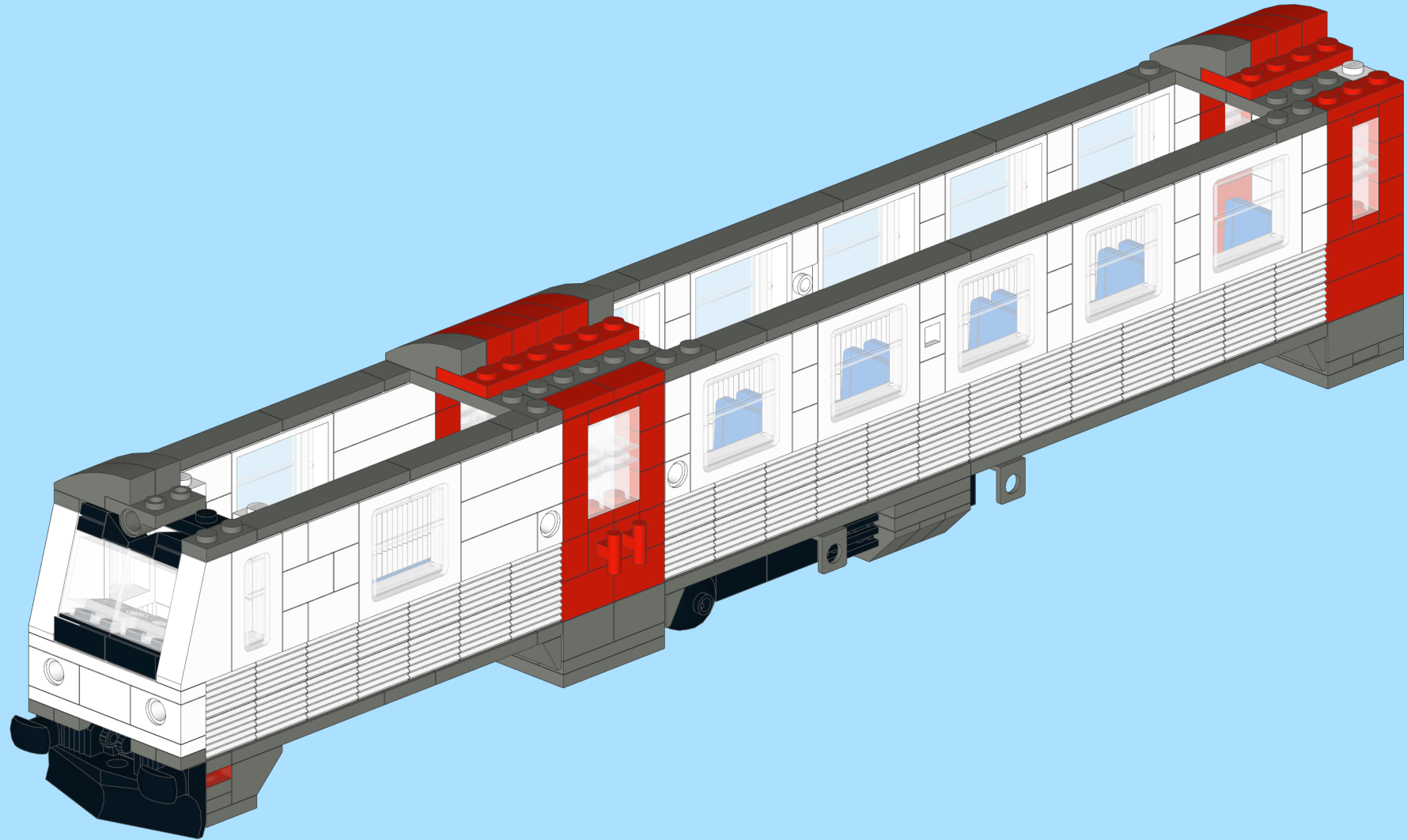
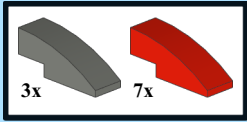

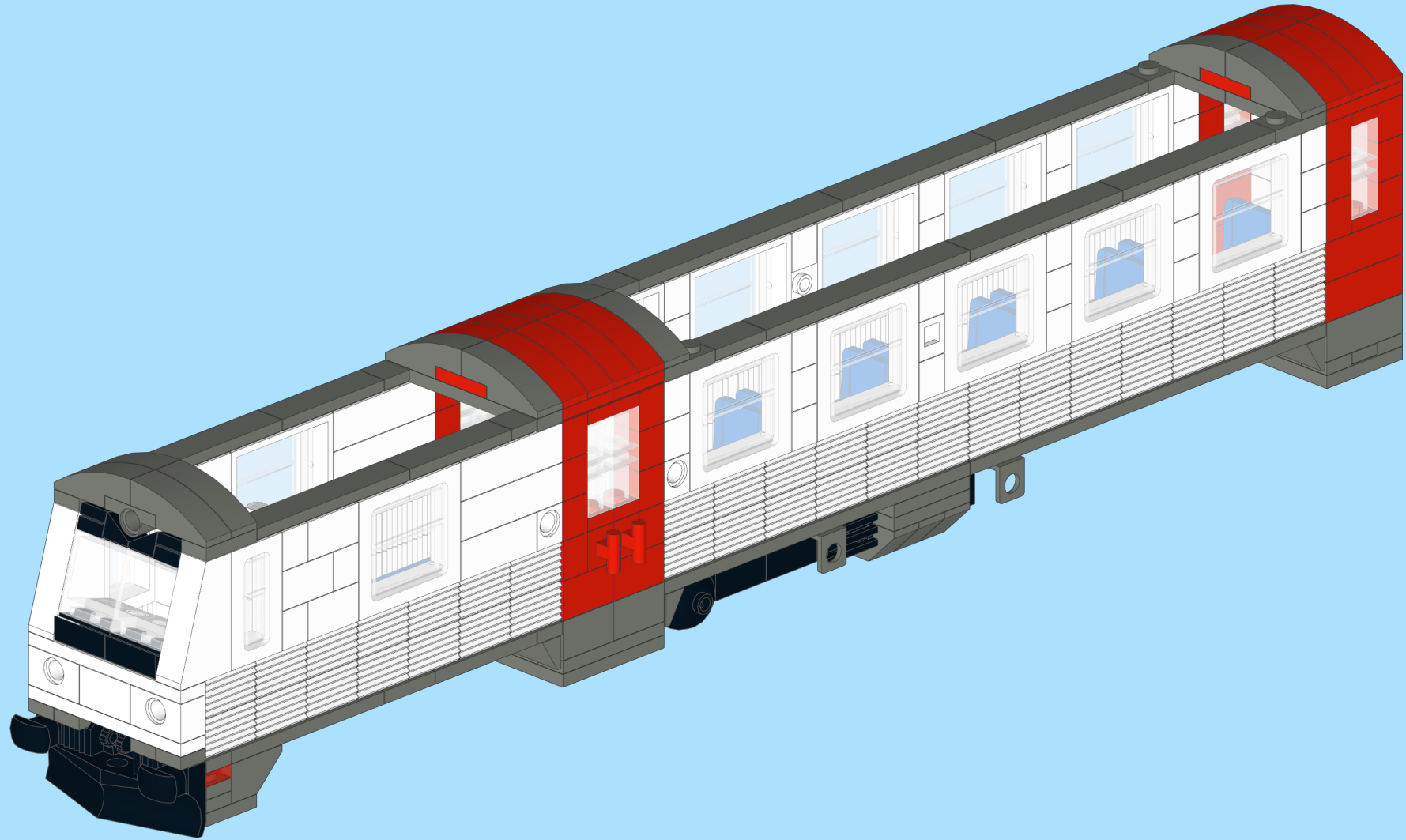
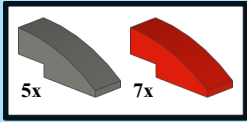







-  1x
-  1x
-  1x
-  1x
-  2x
-  2x

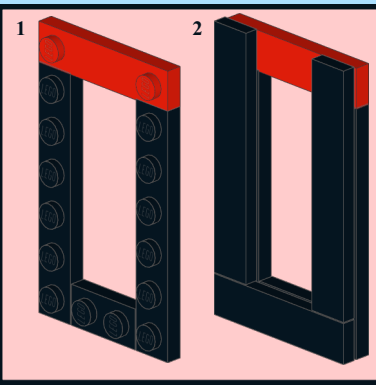
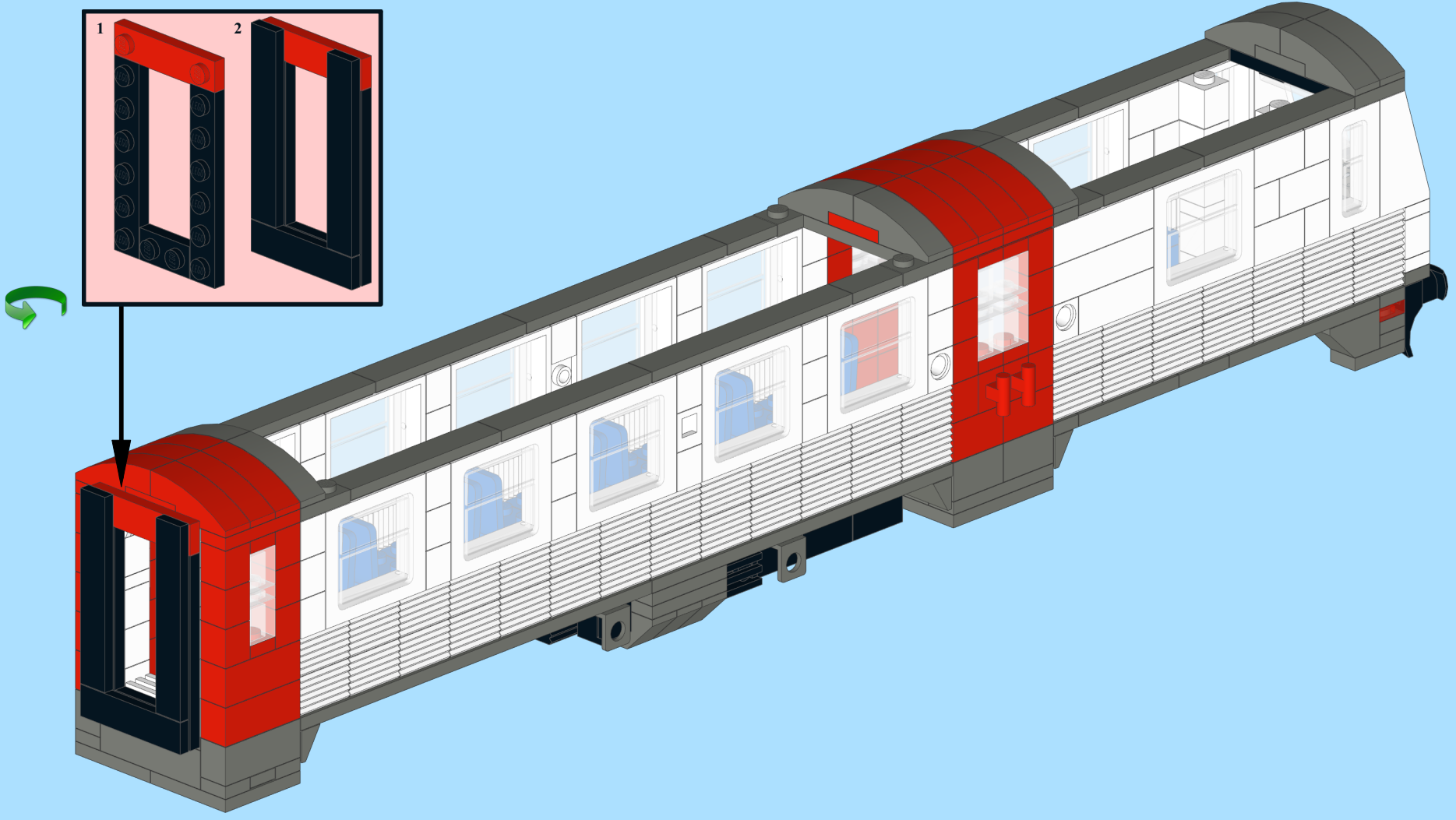

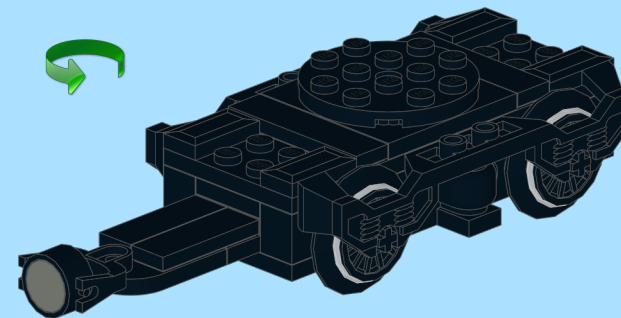
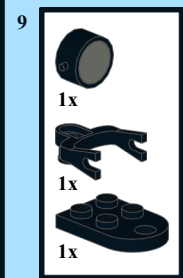
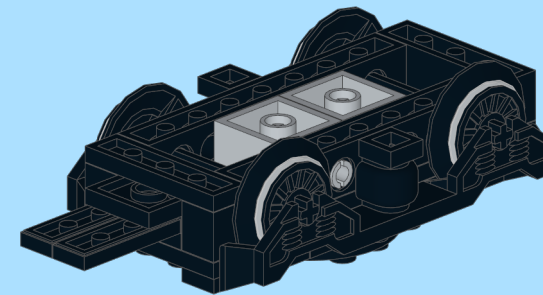
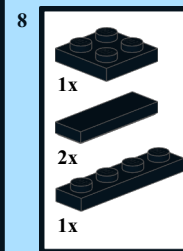
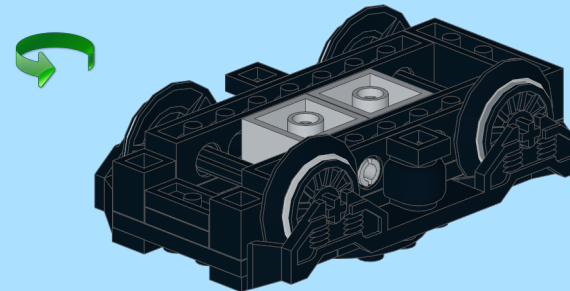
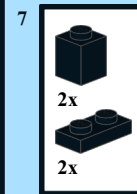
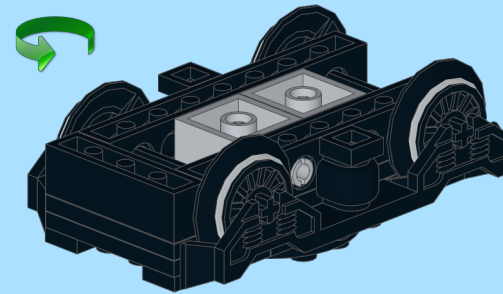
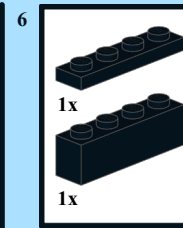
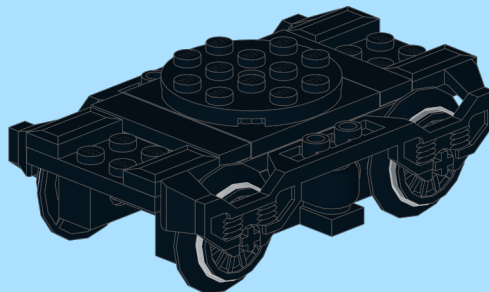
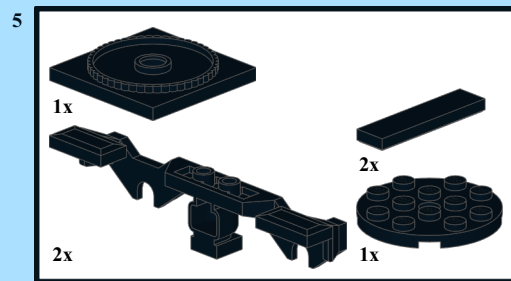
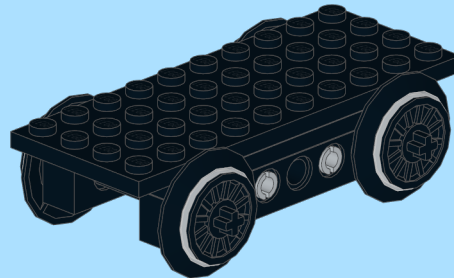
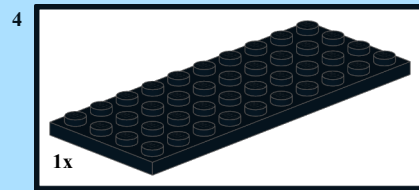
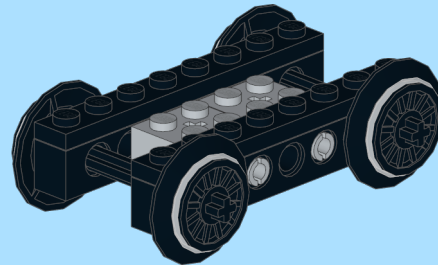
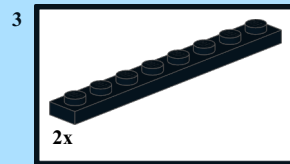
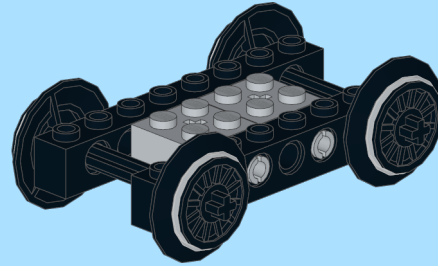
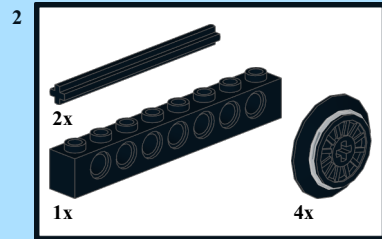
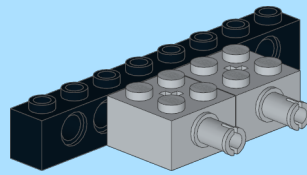
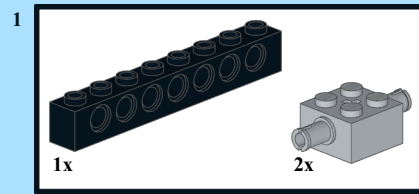

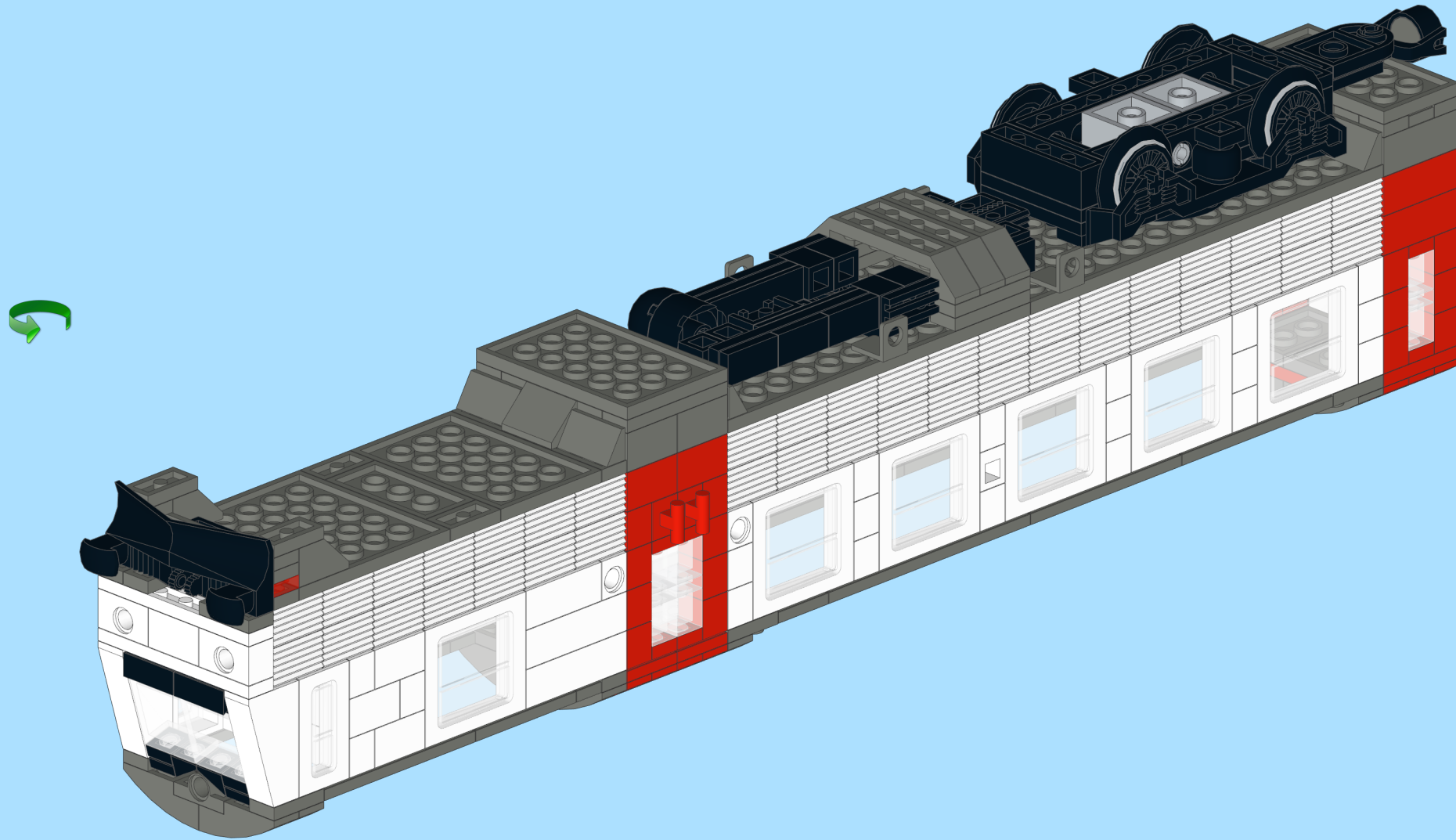

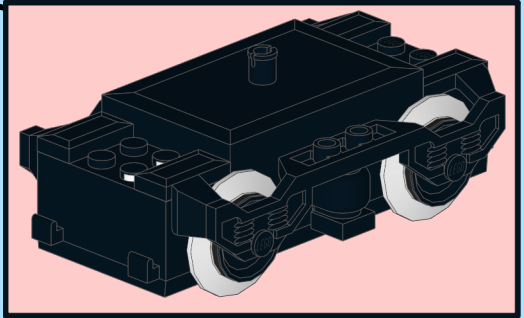
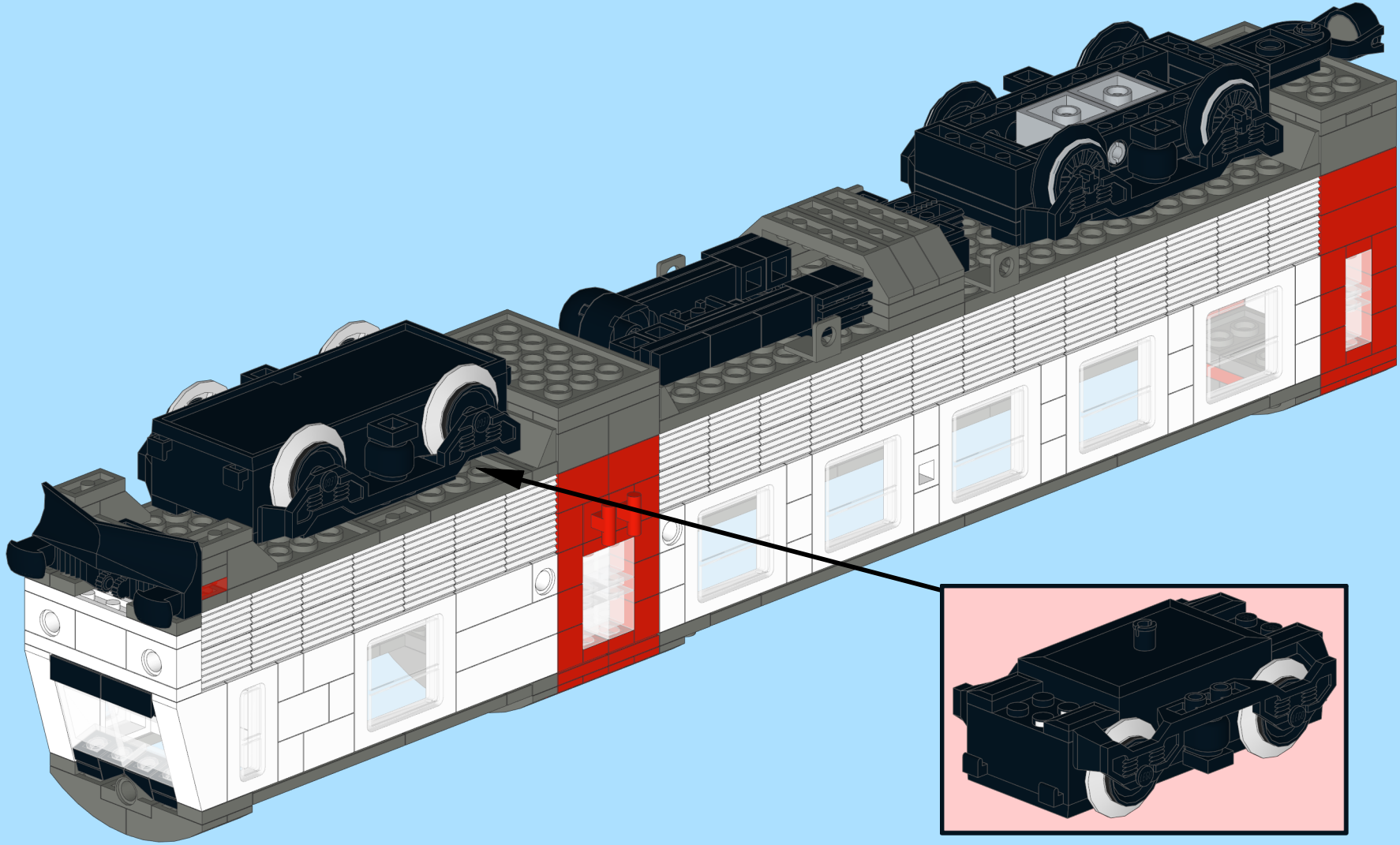
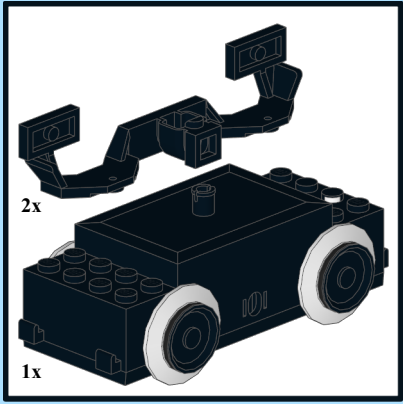

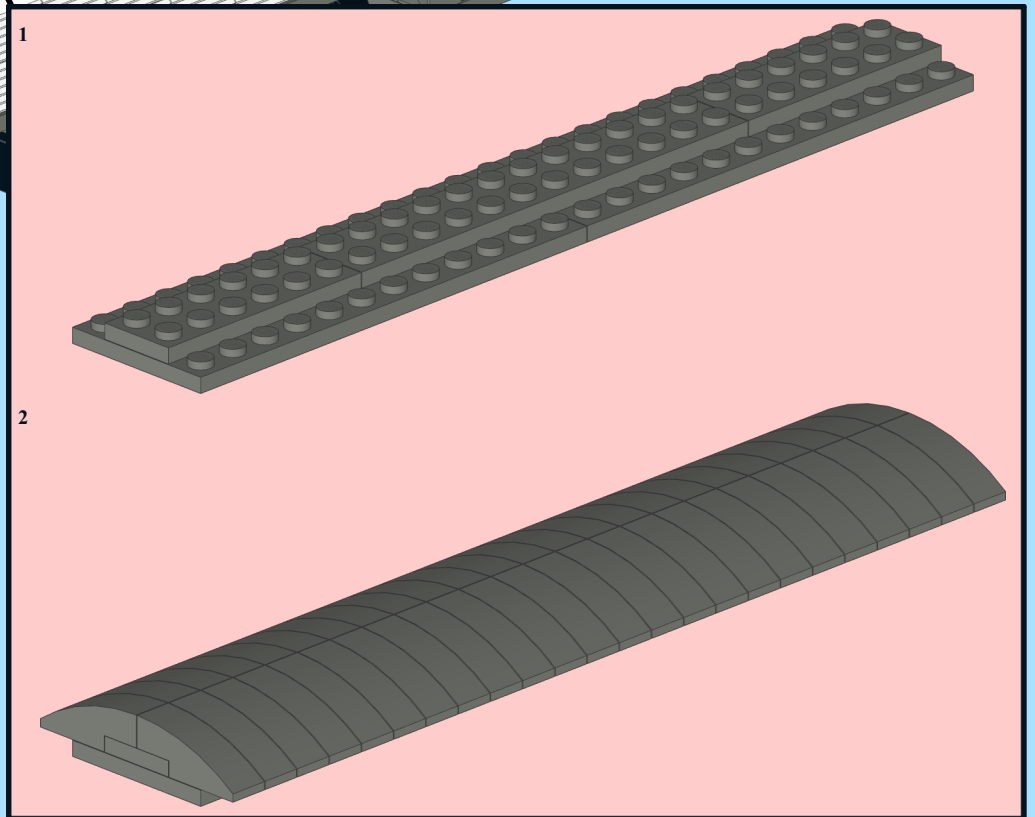
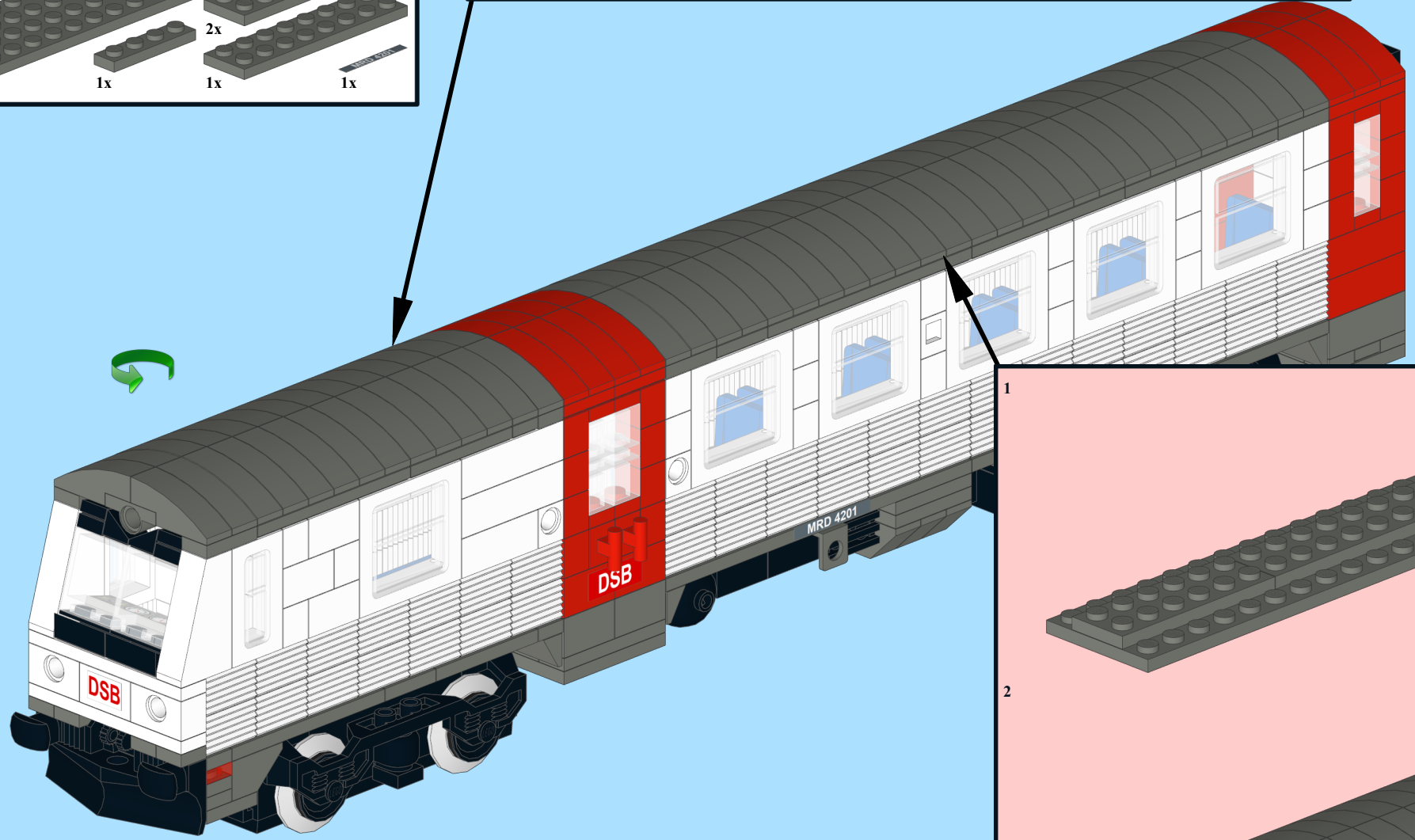
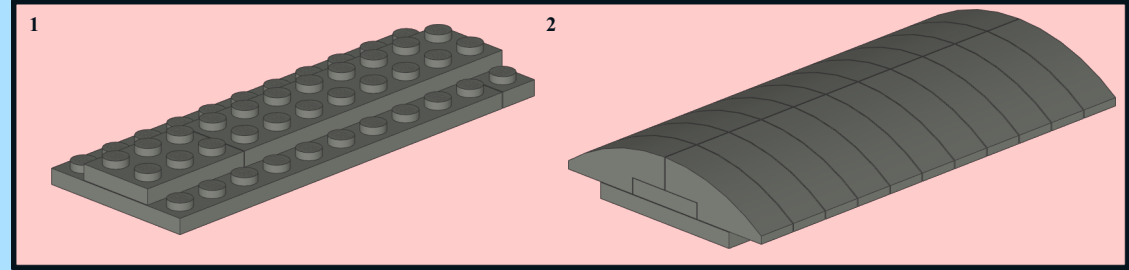
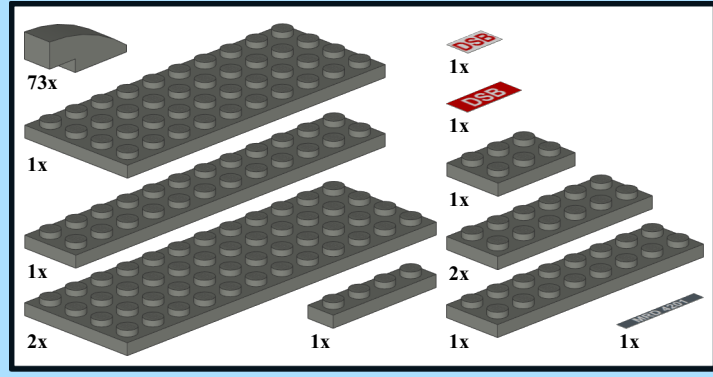

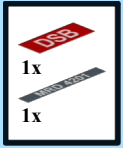

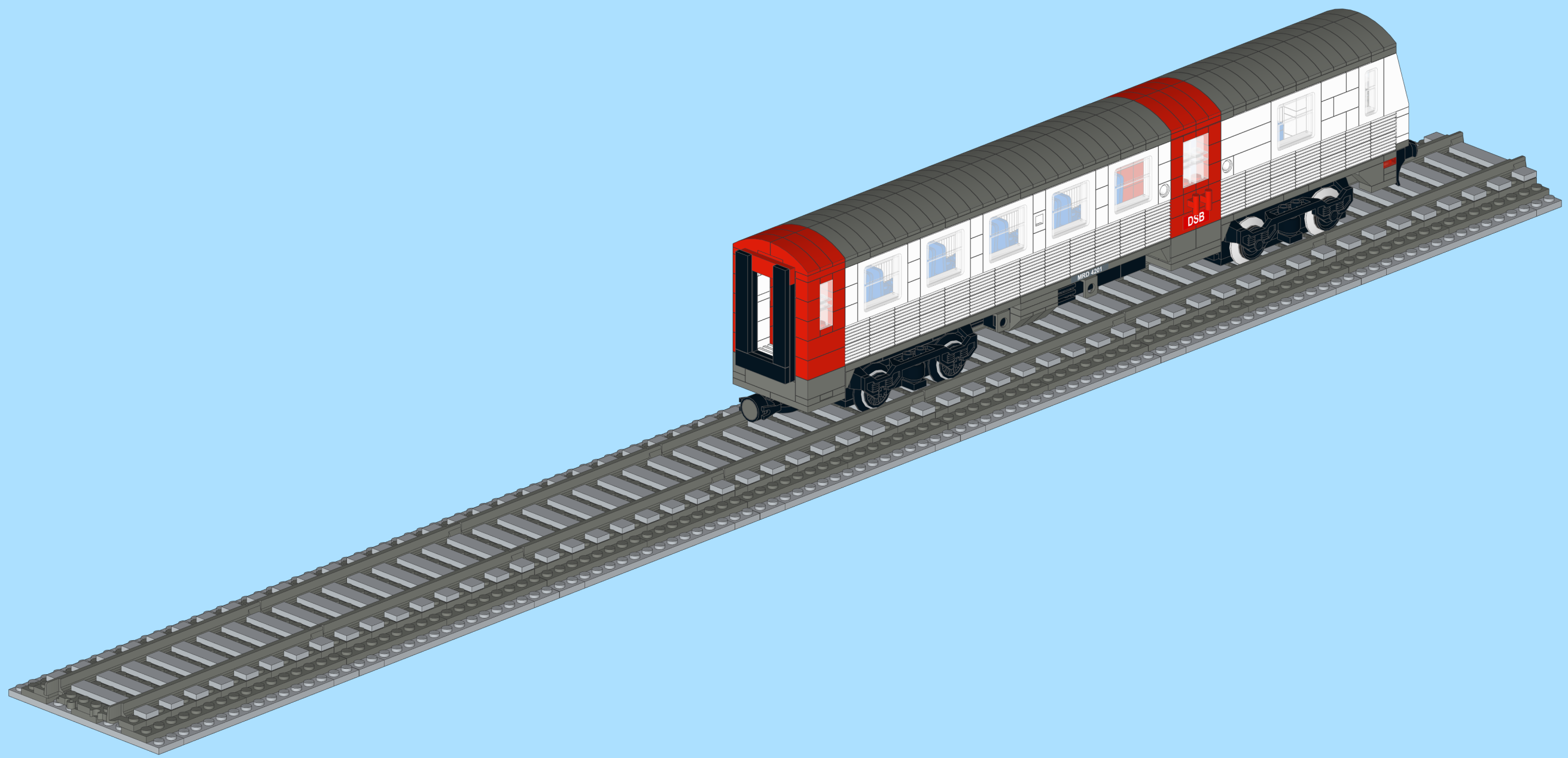

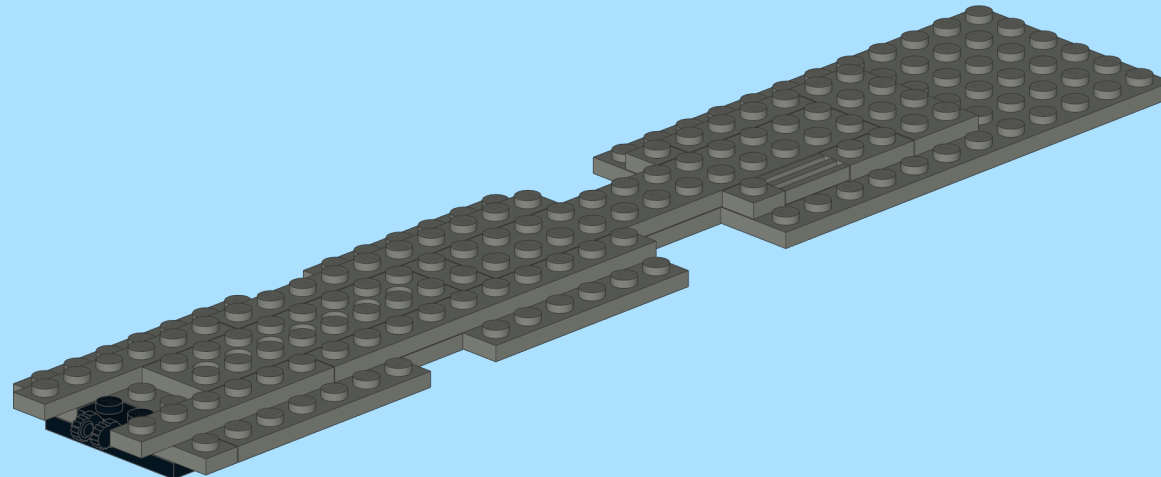
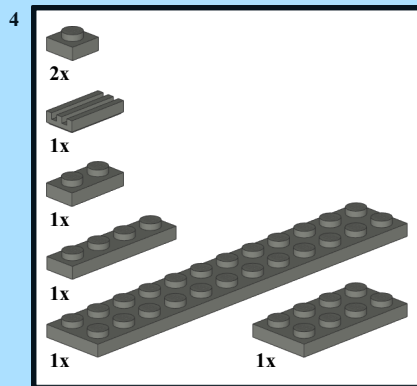
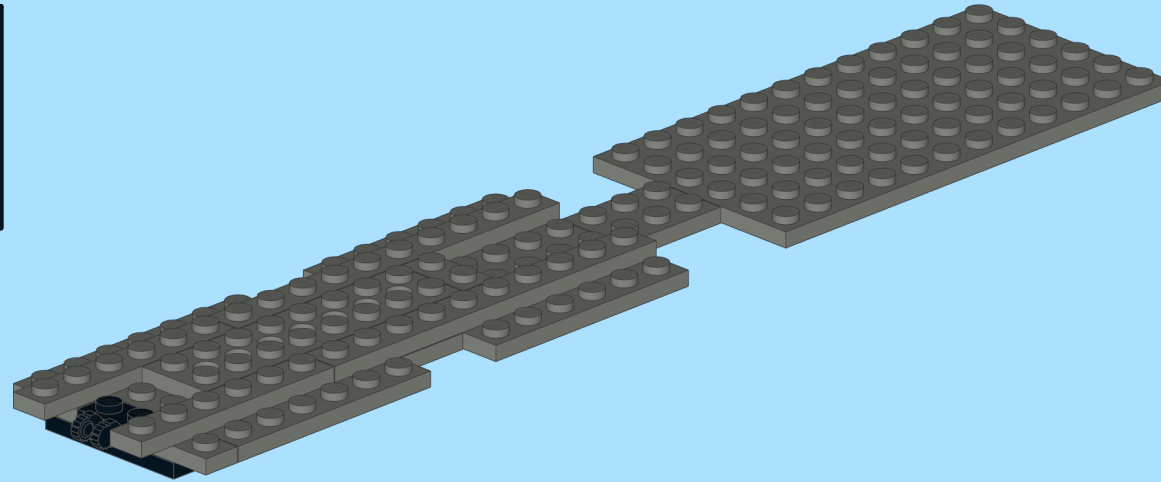
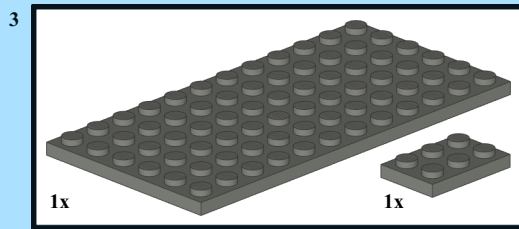
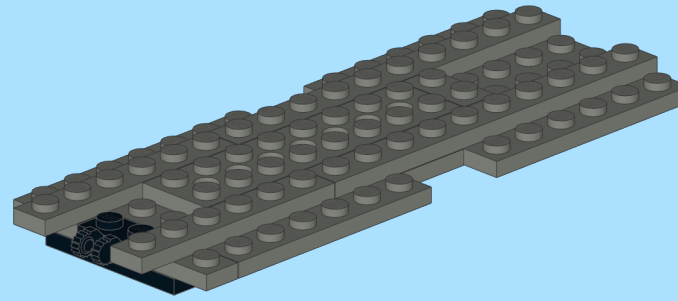
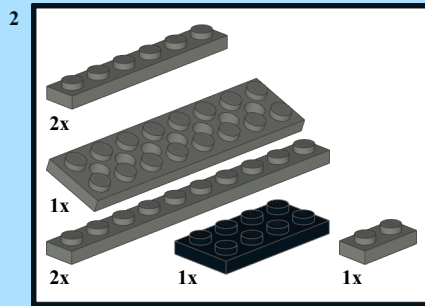
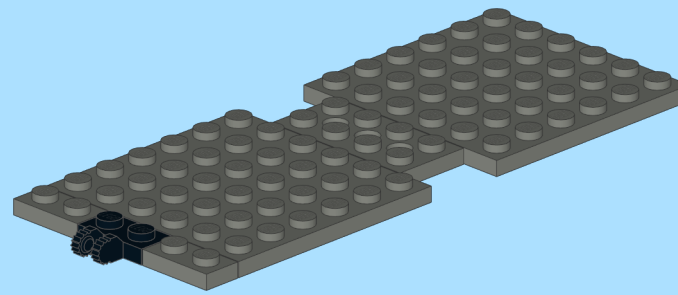
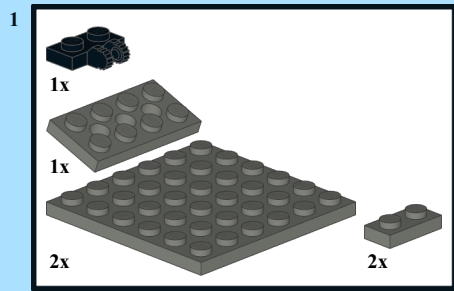

5

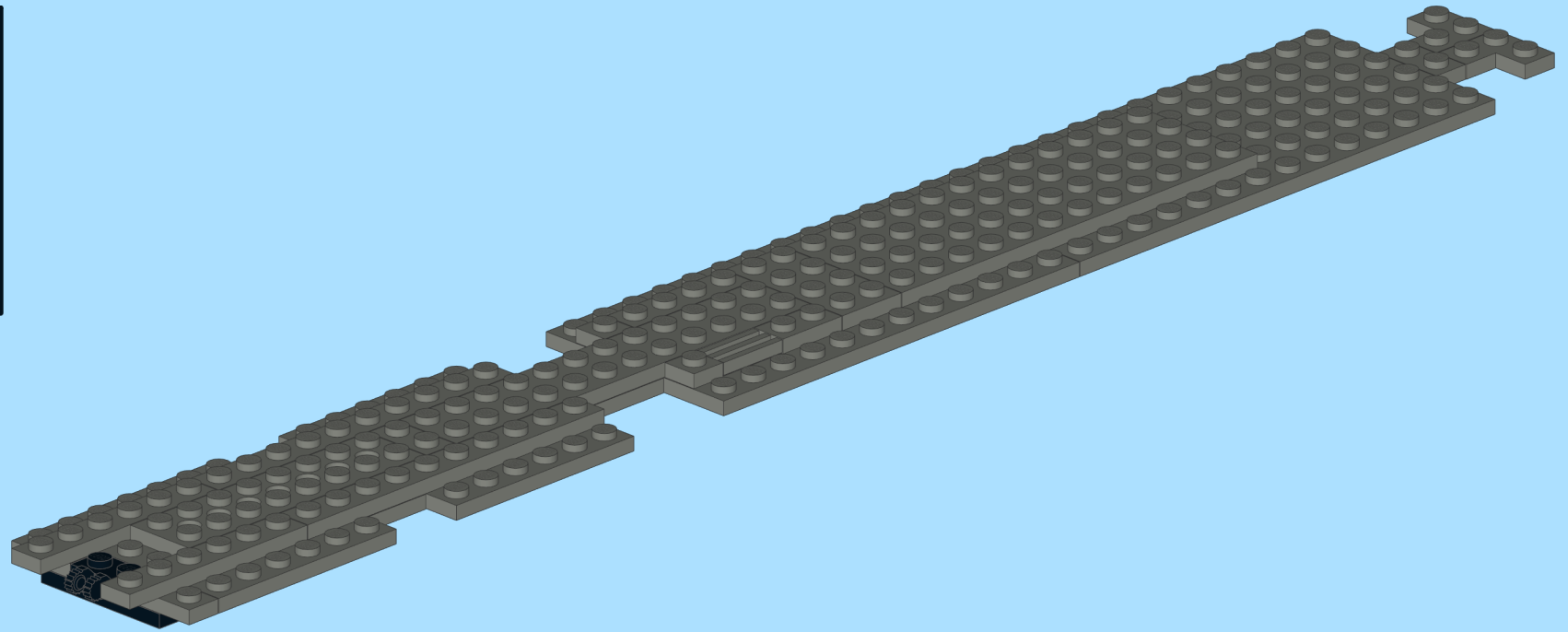
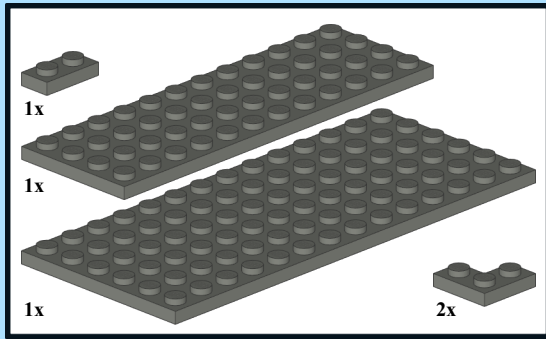

6

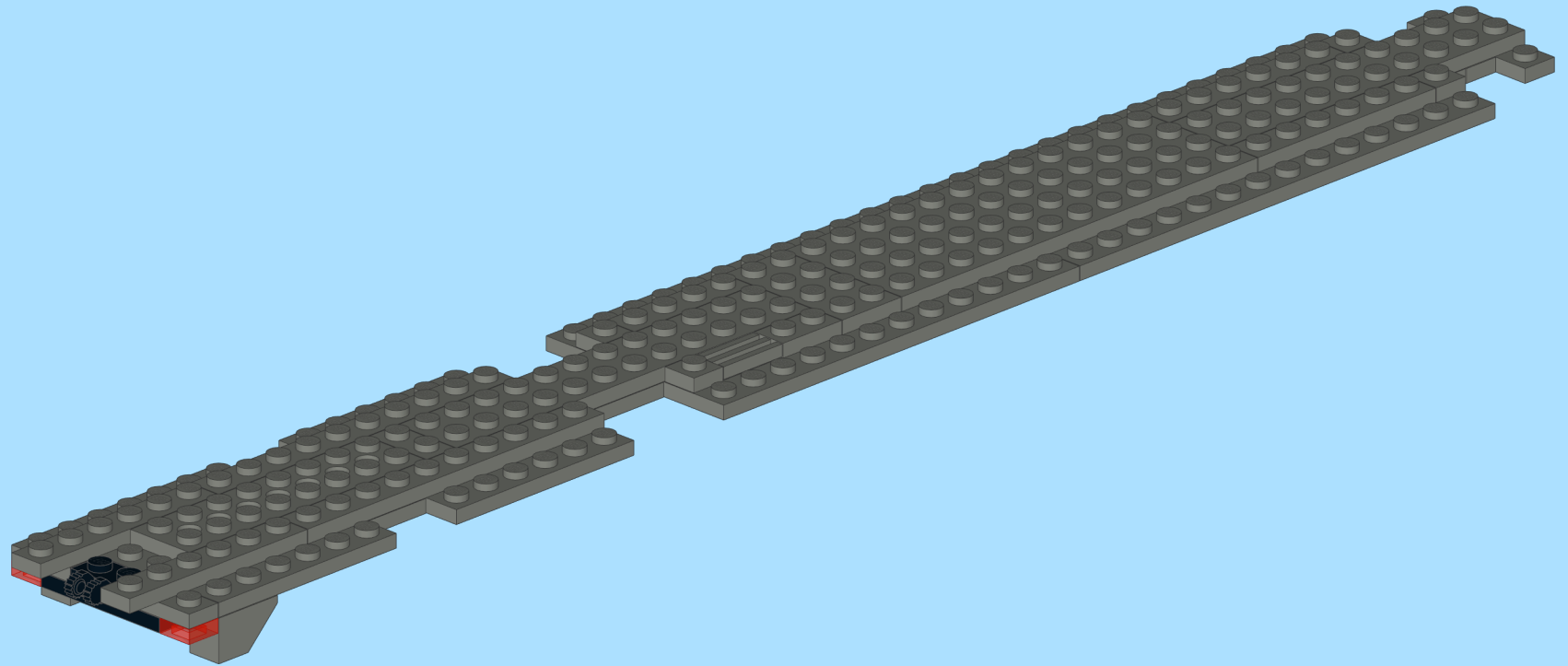
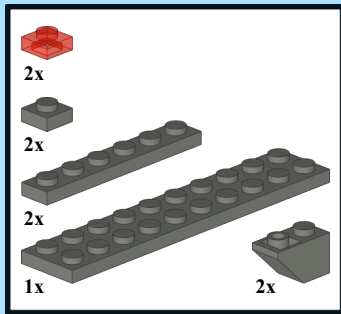

7

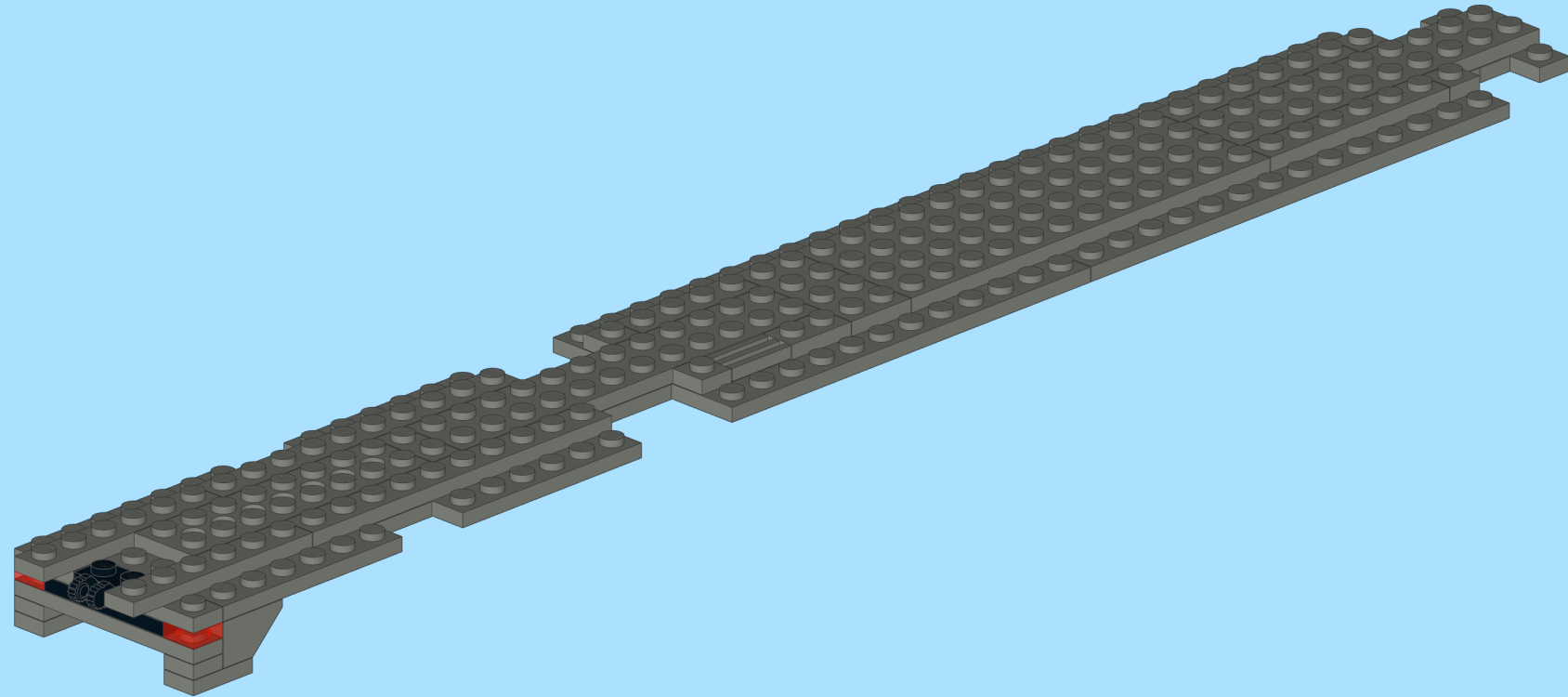
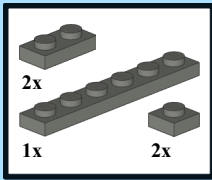

8

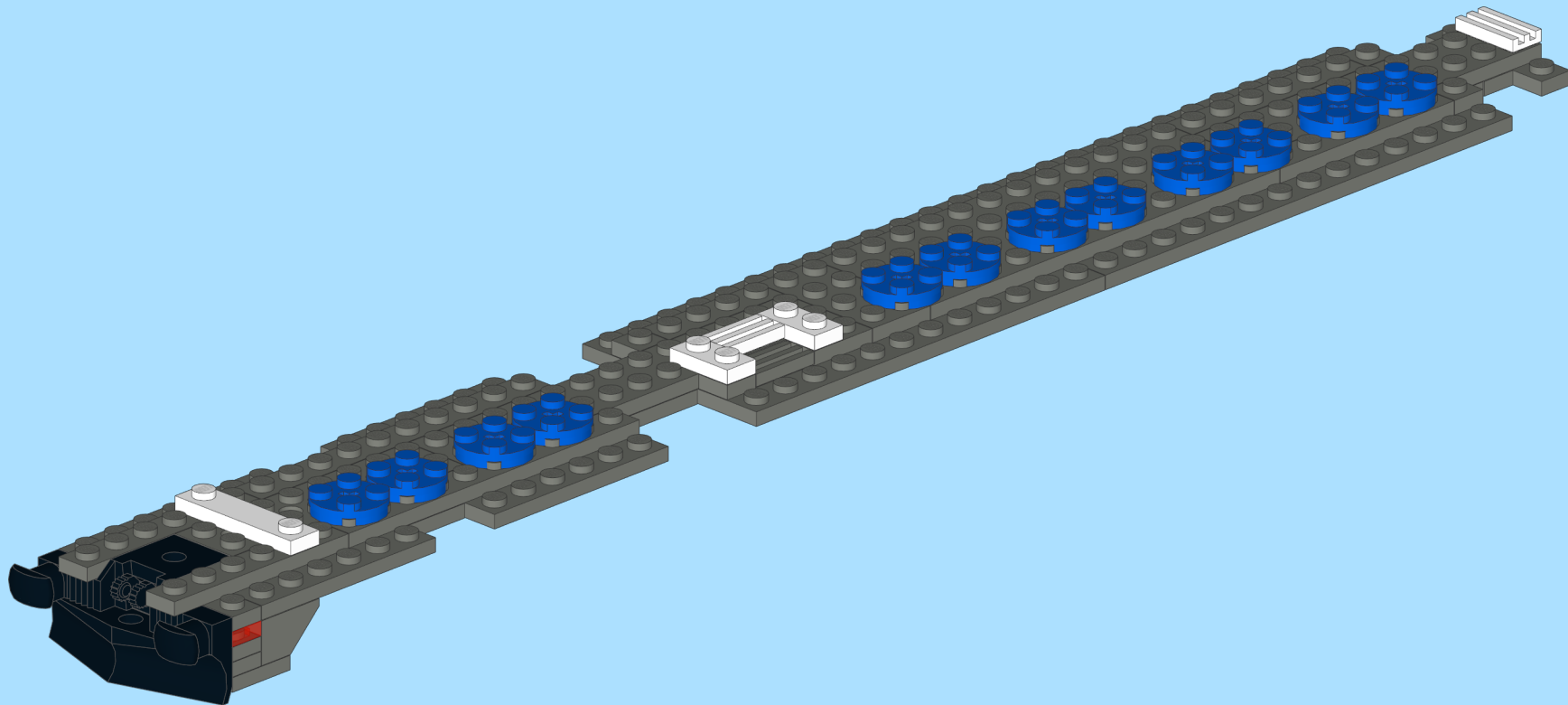
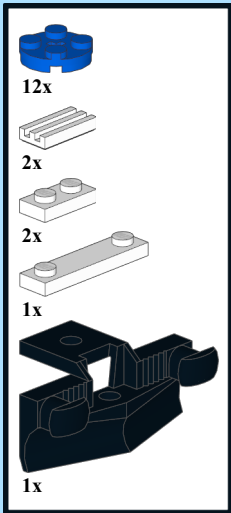

9

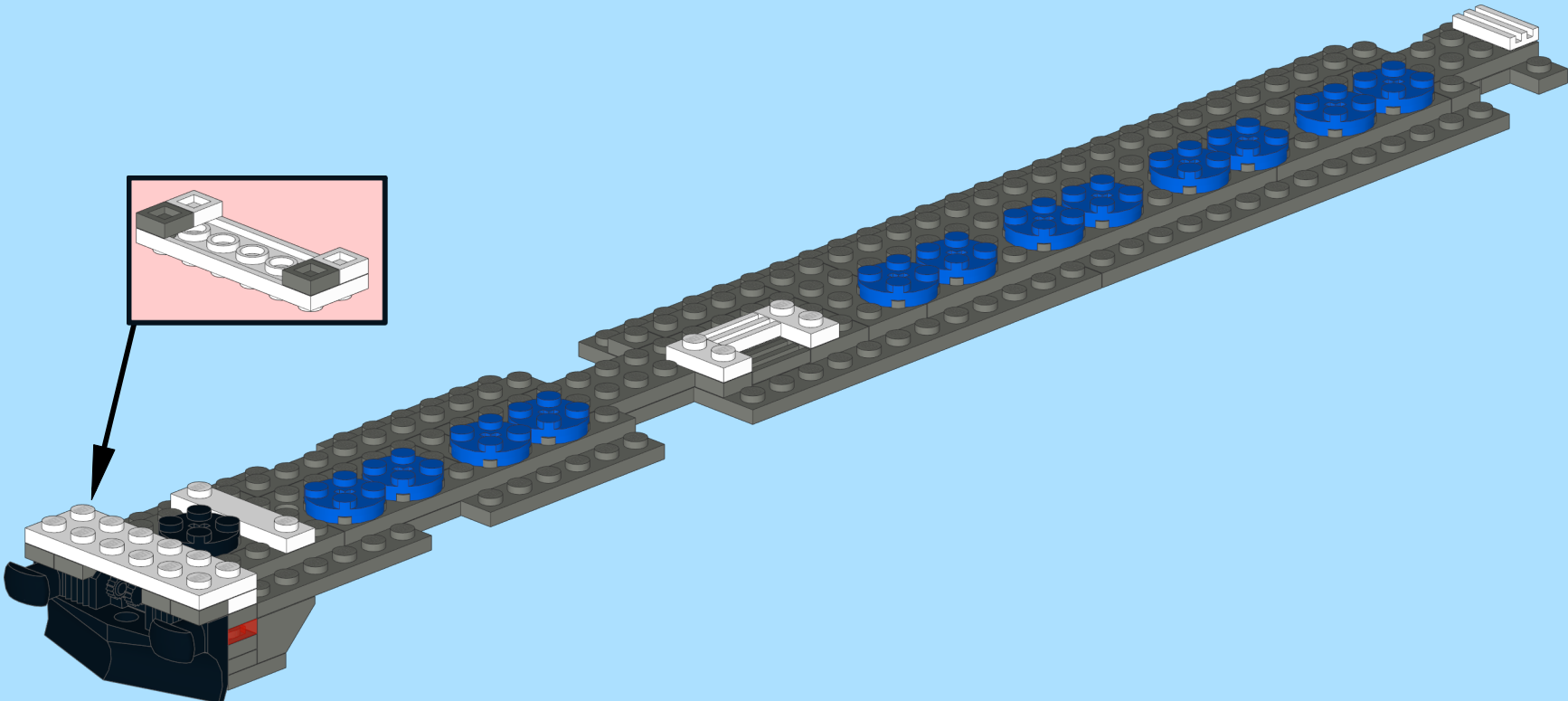
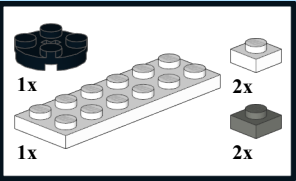

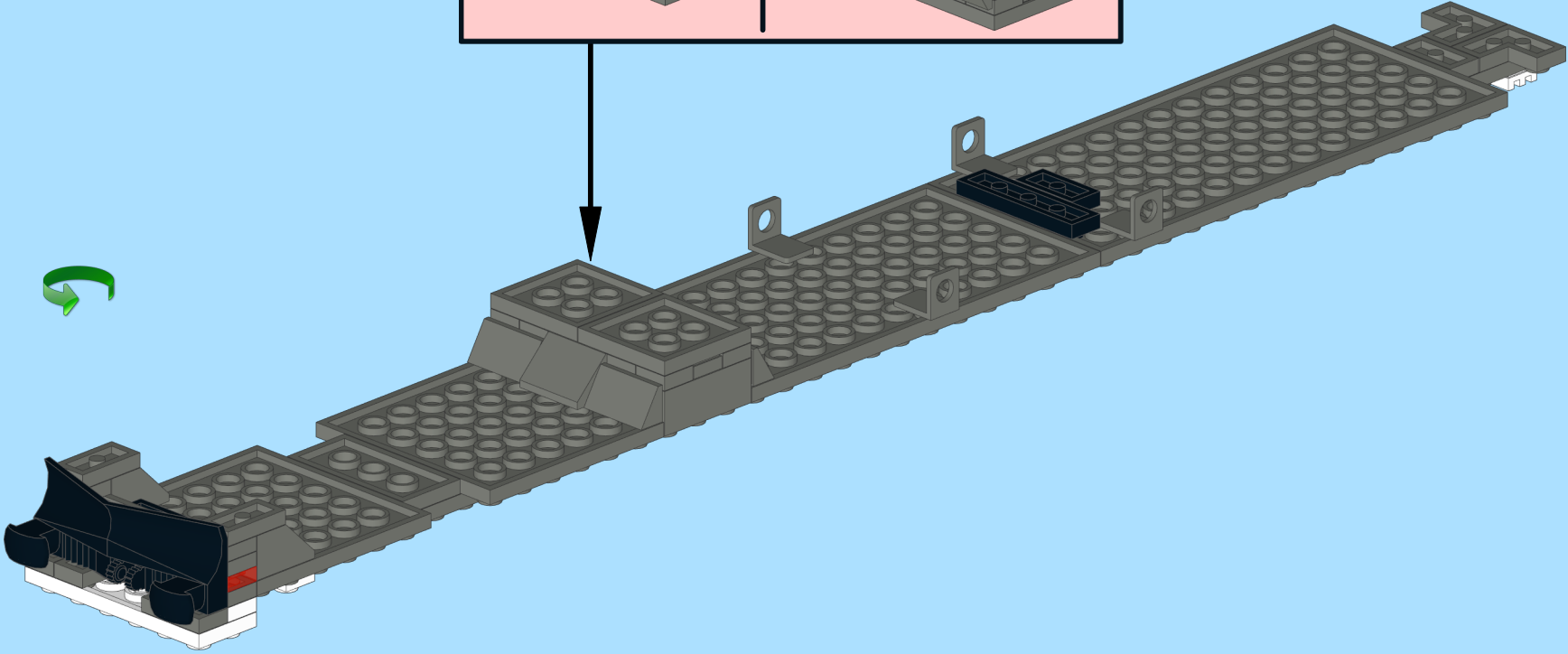
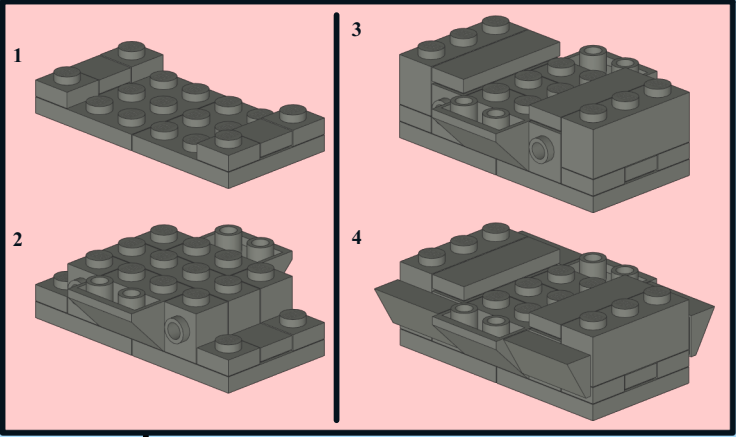
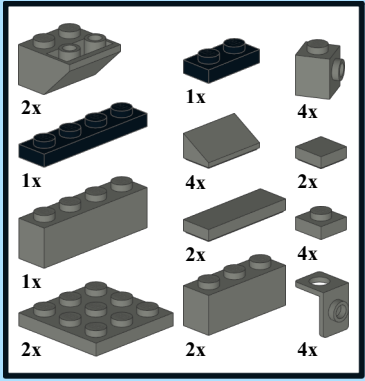

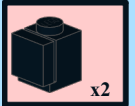
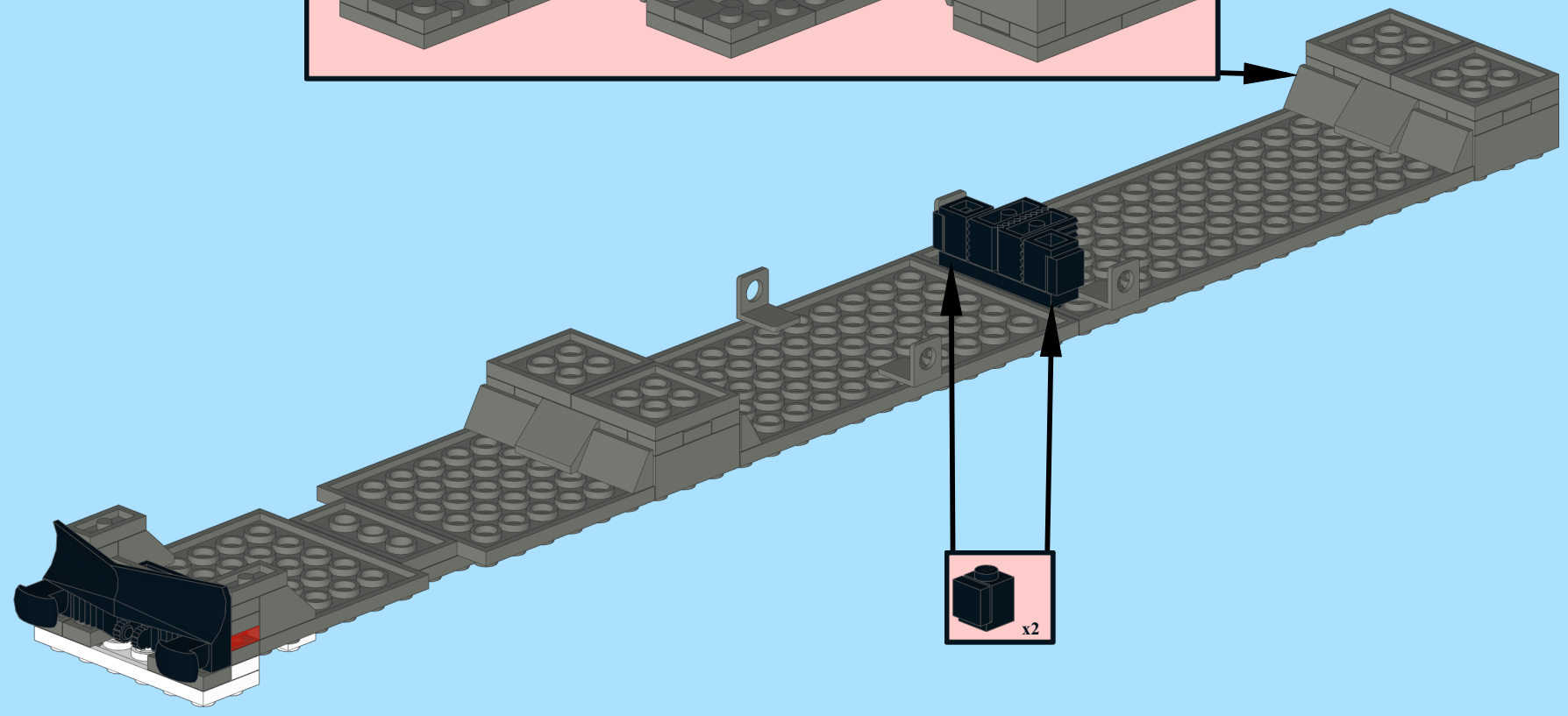
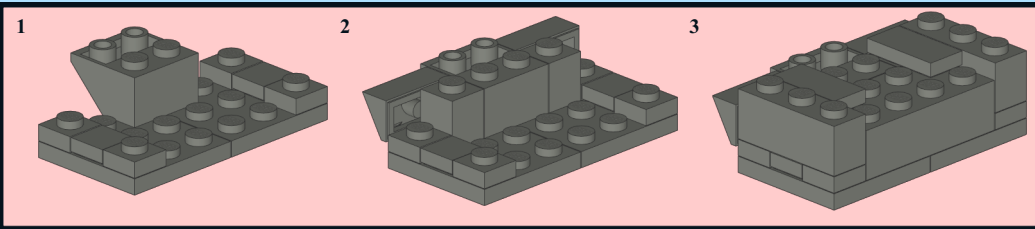
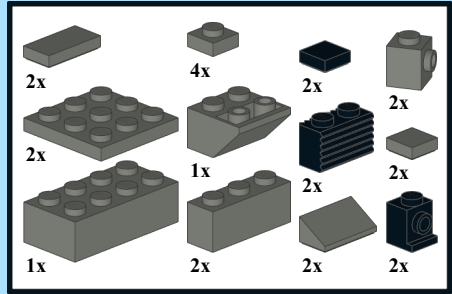

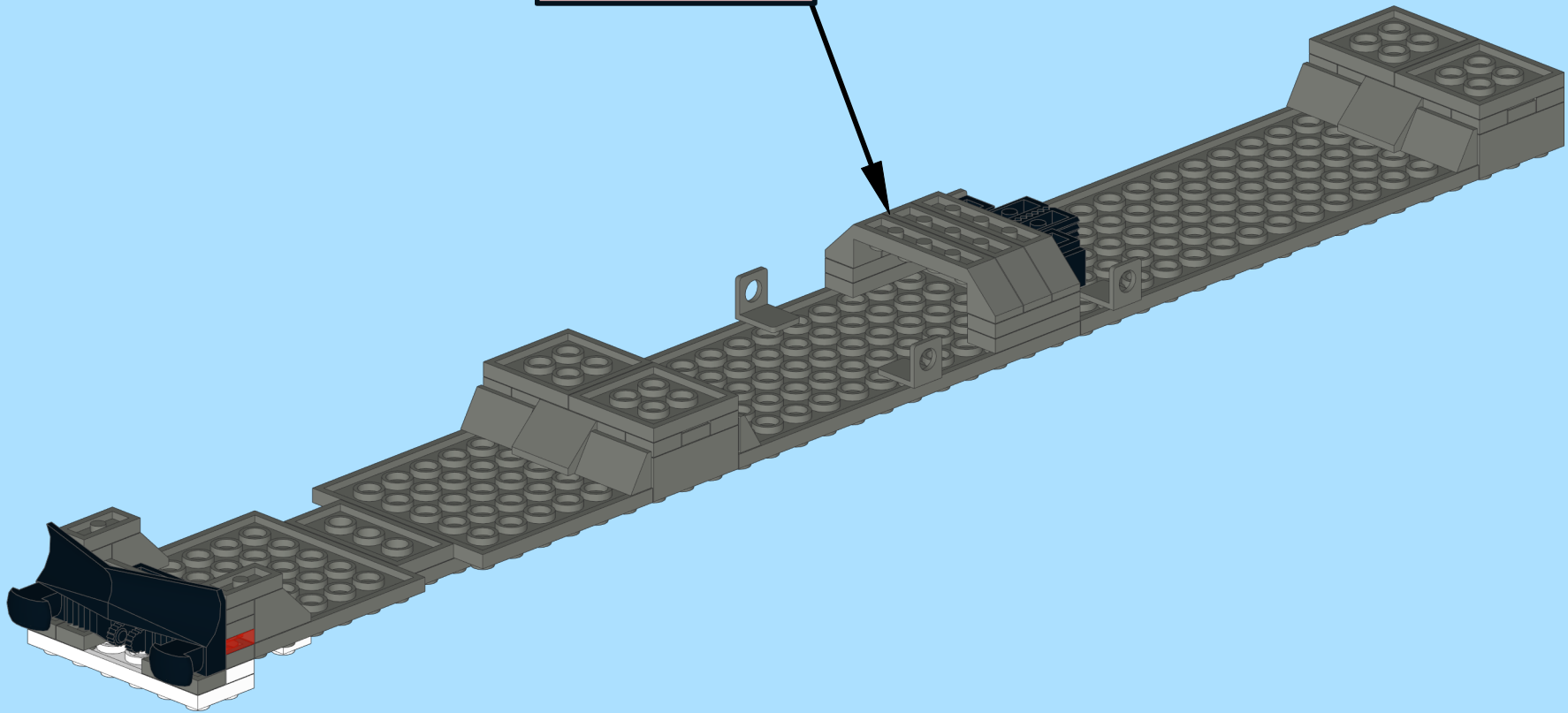
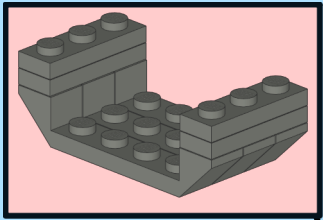
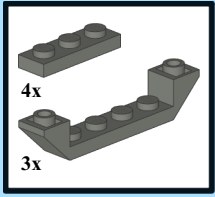

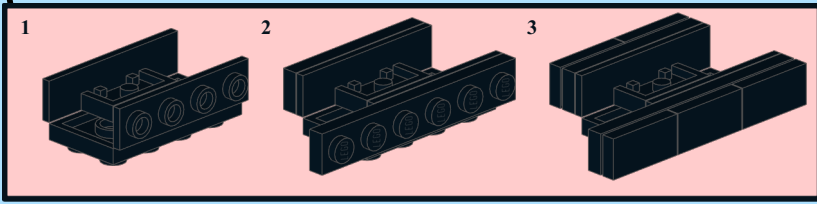
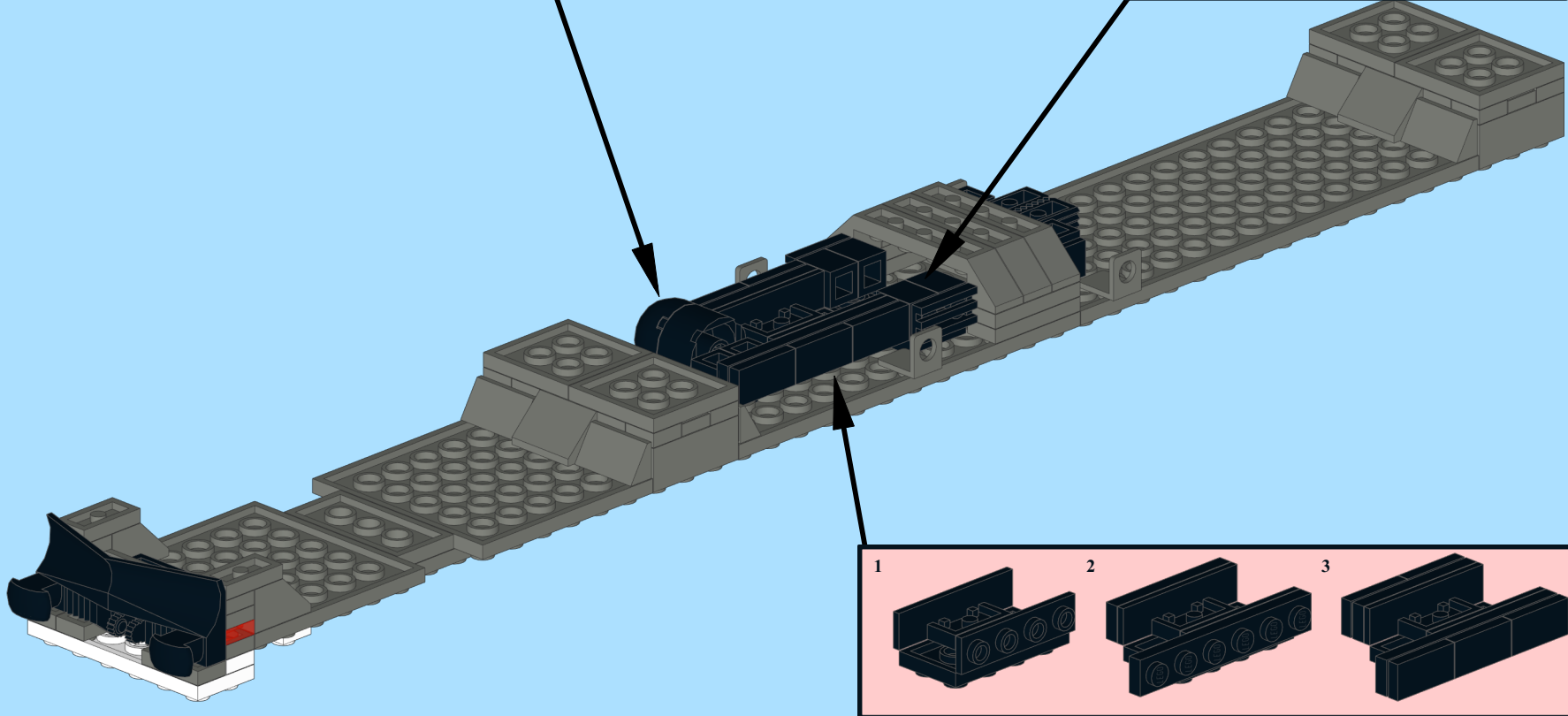
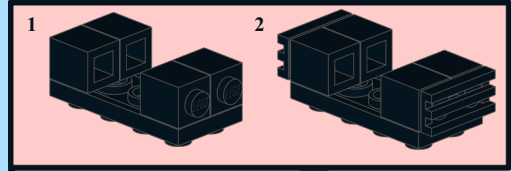
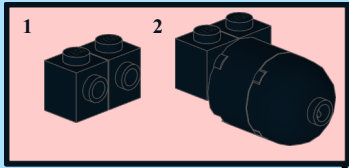
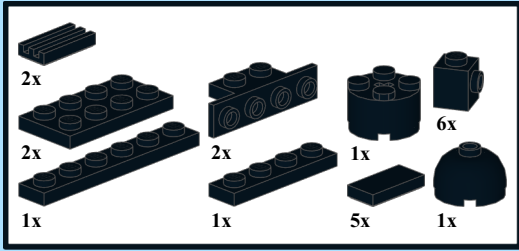

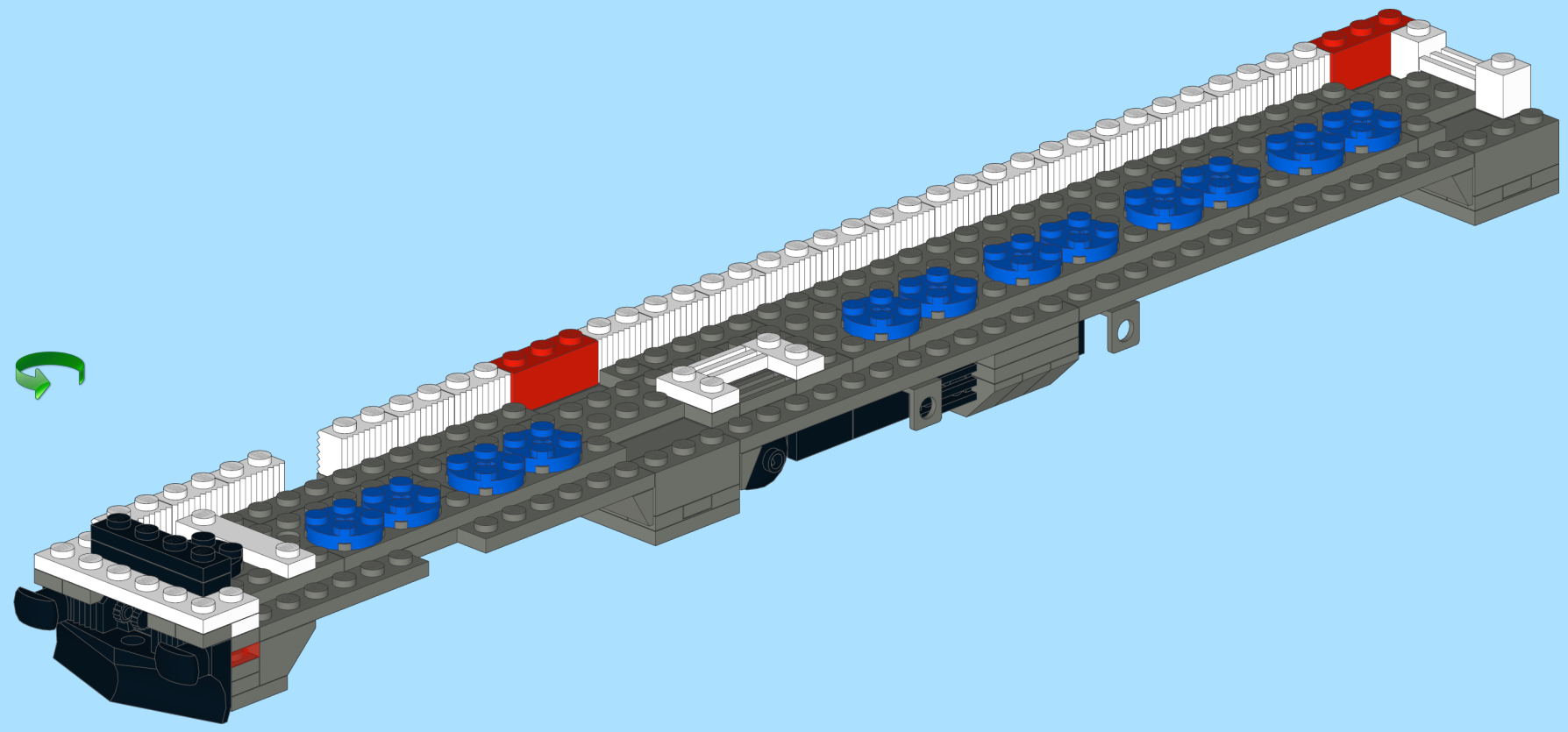
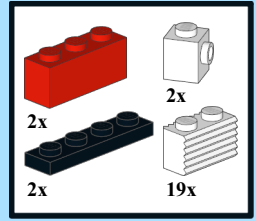

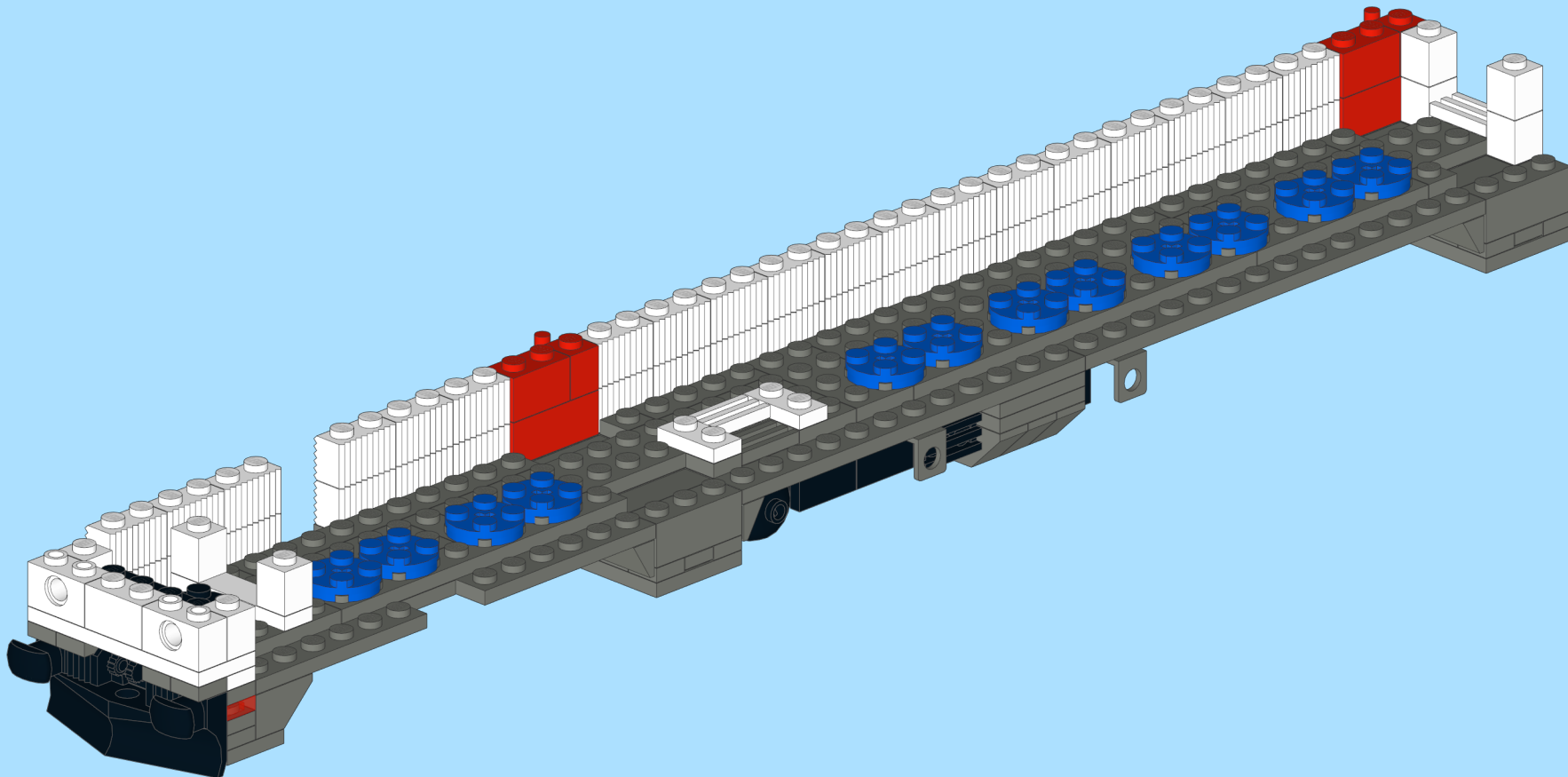
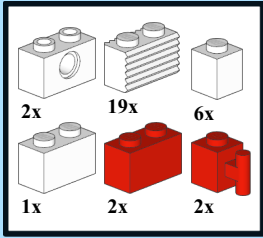

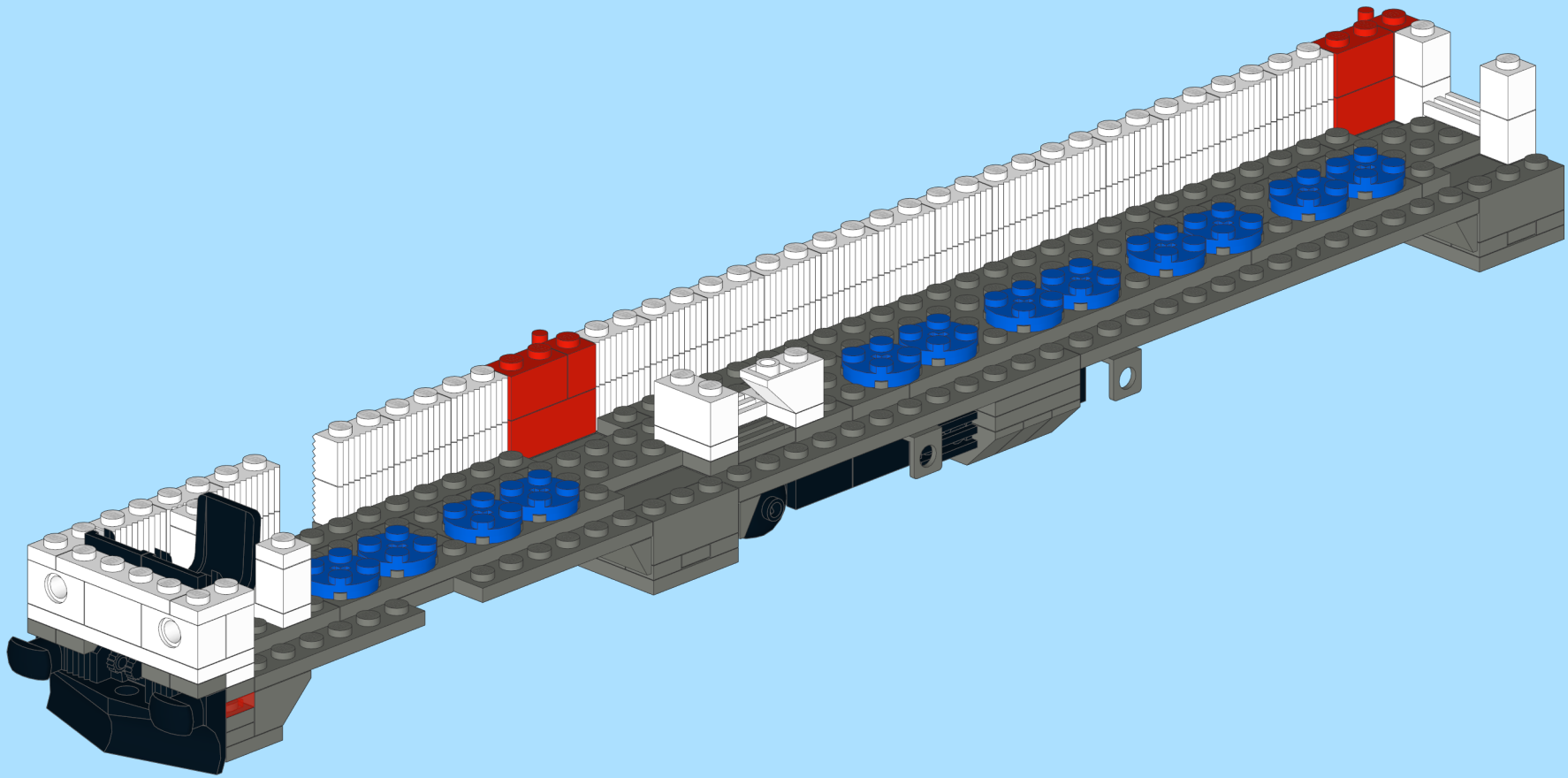
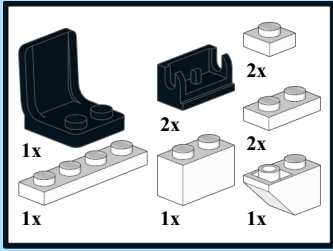

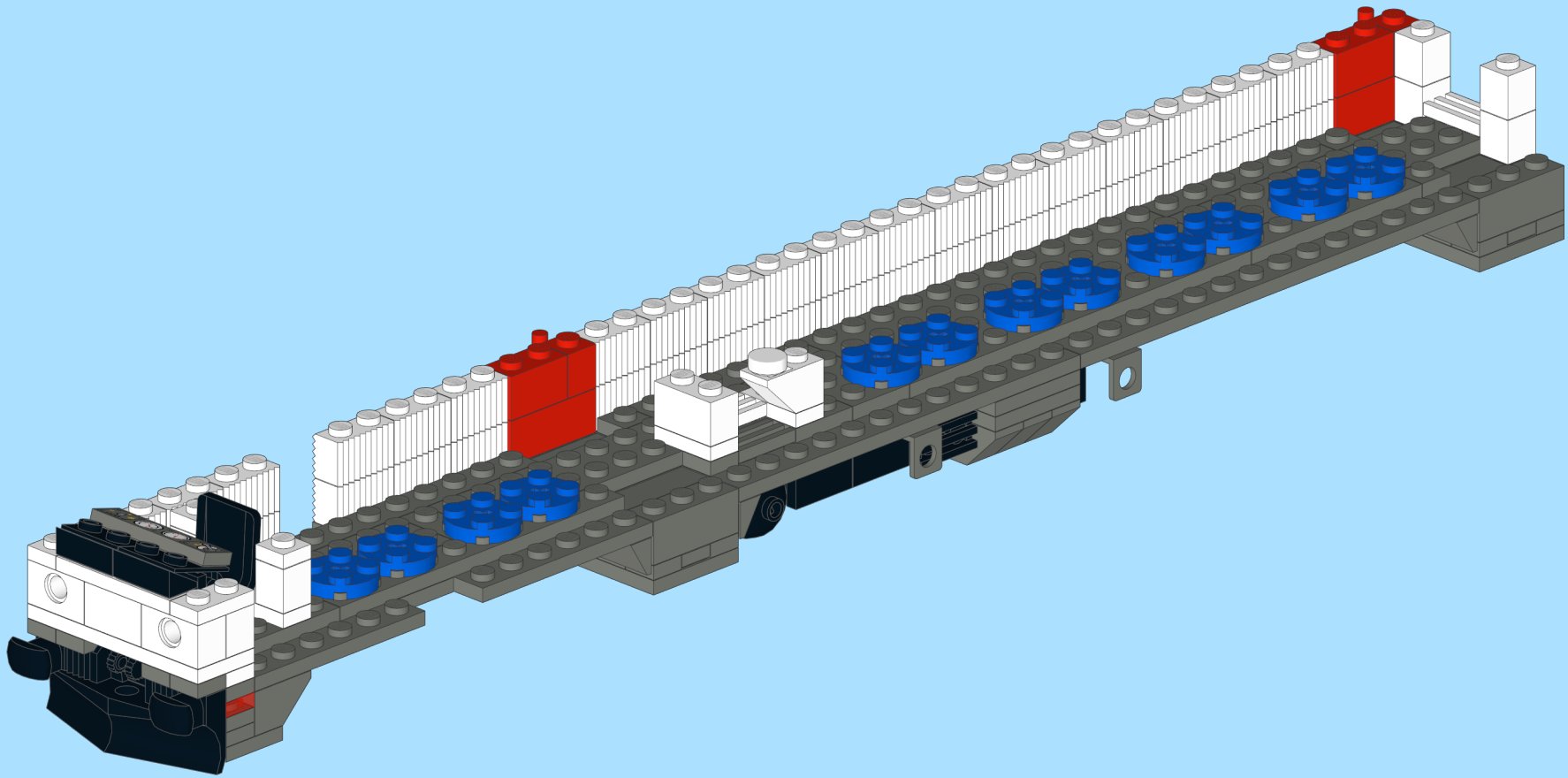
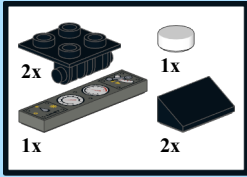

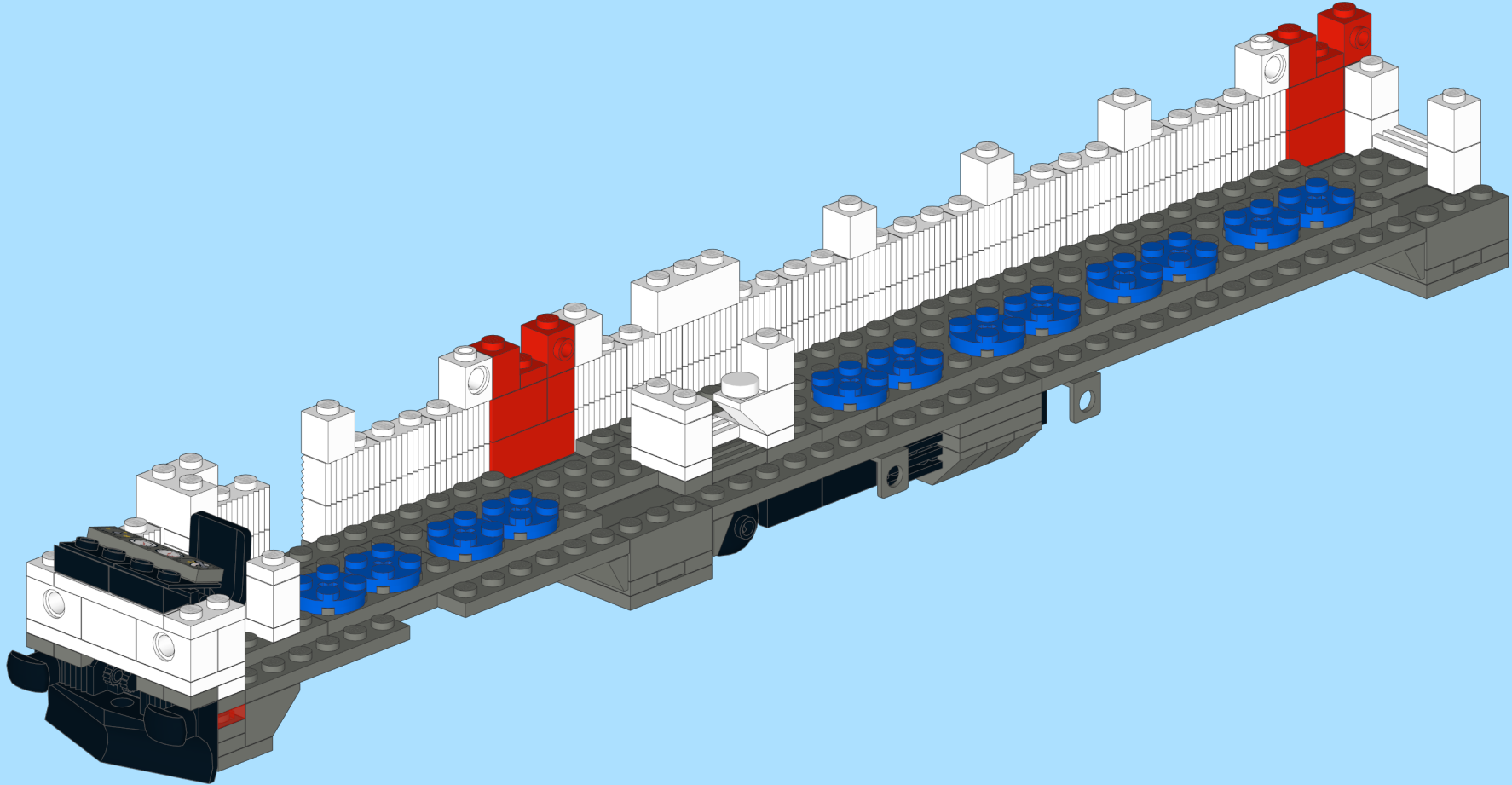
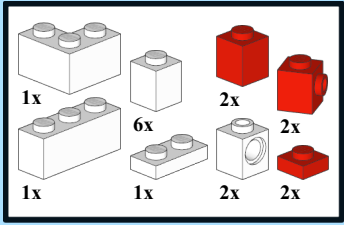

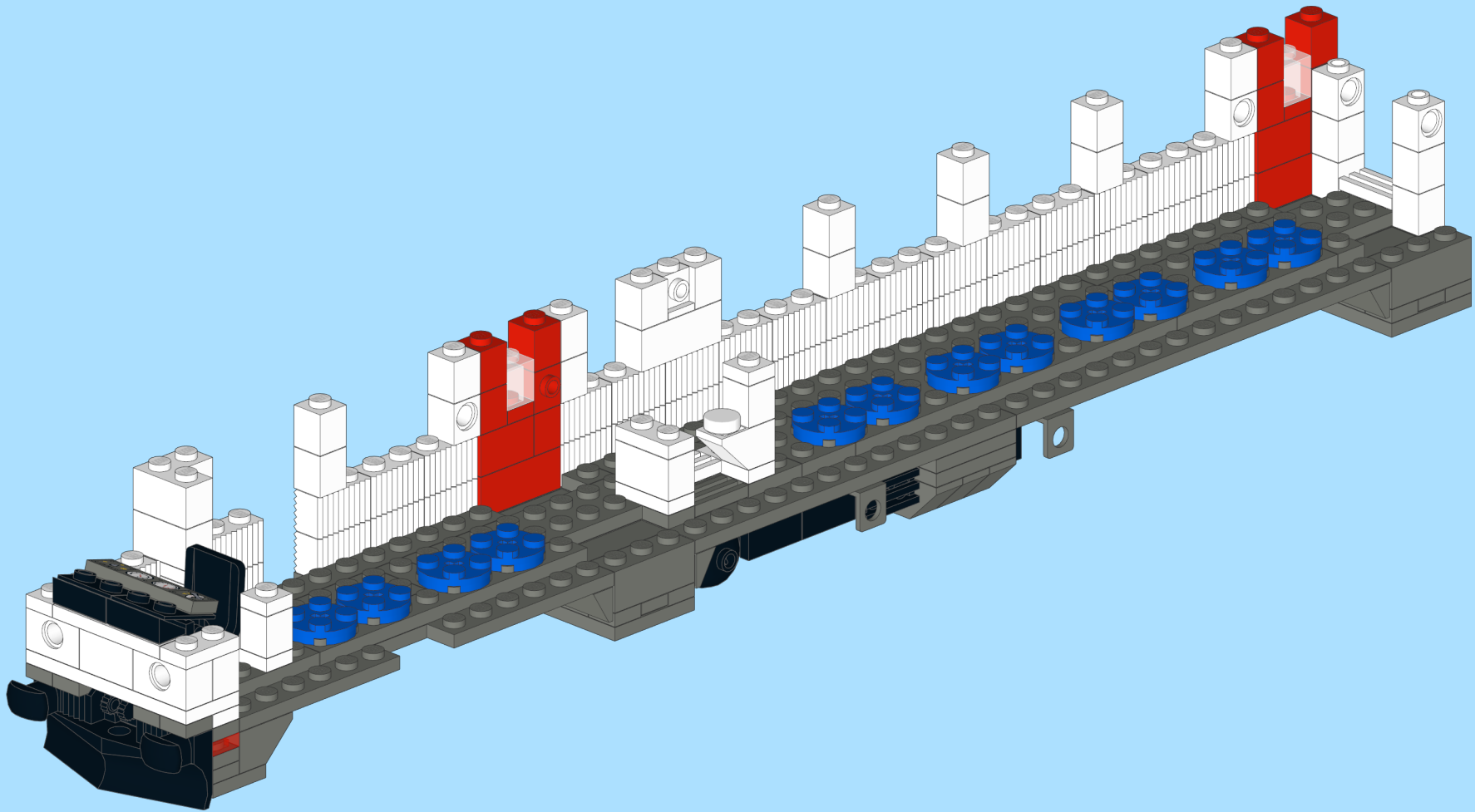
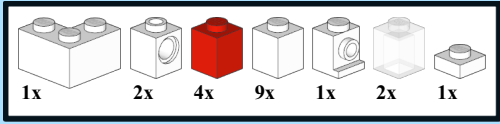

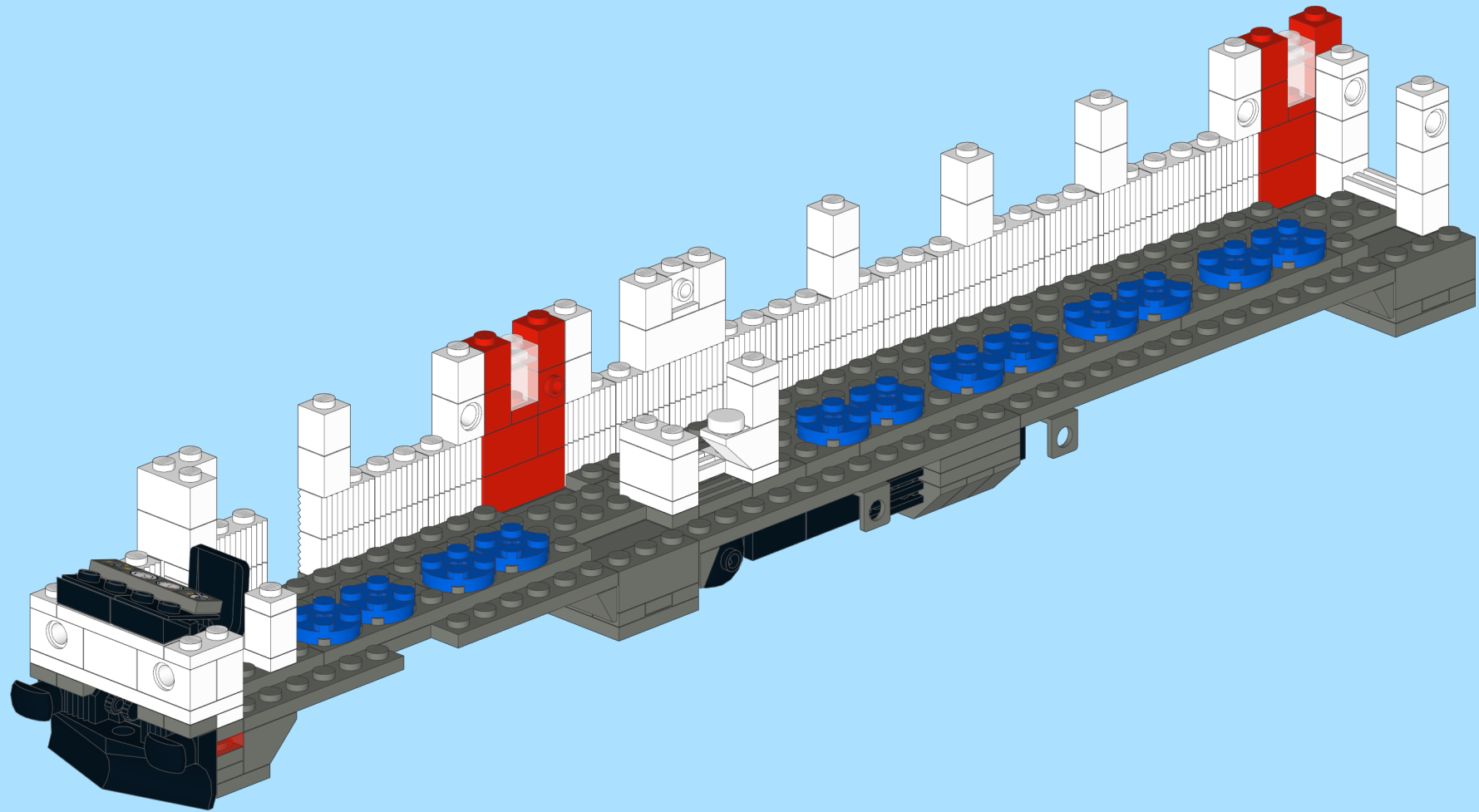
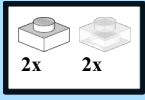

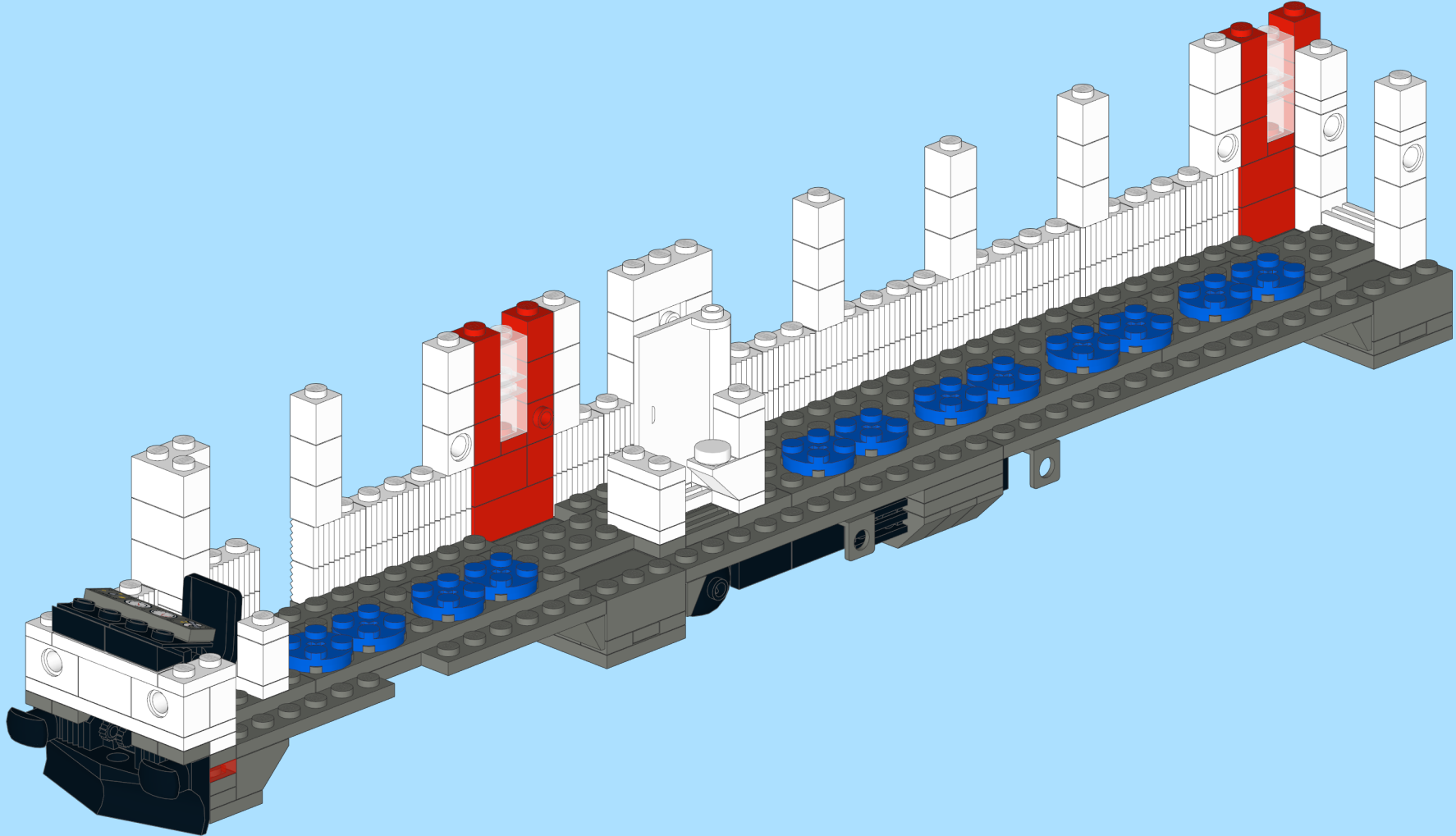
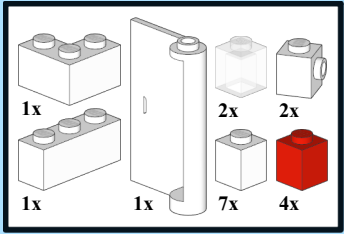

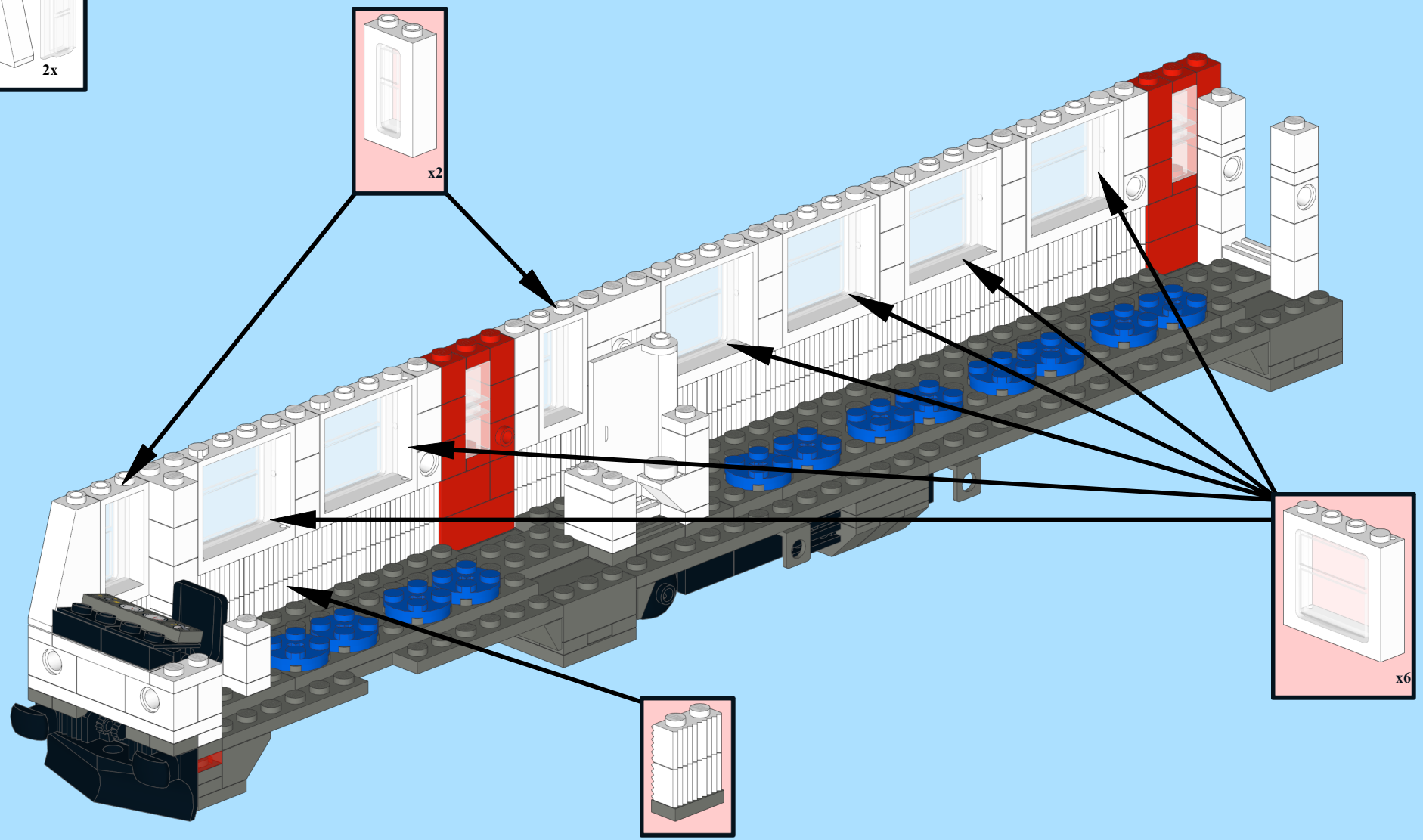
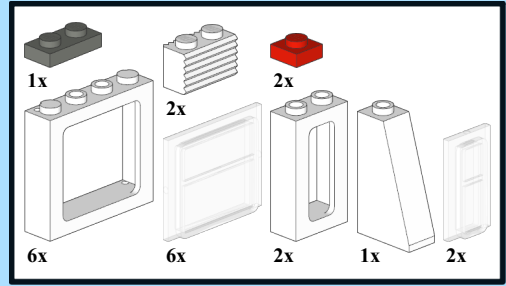

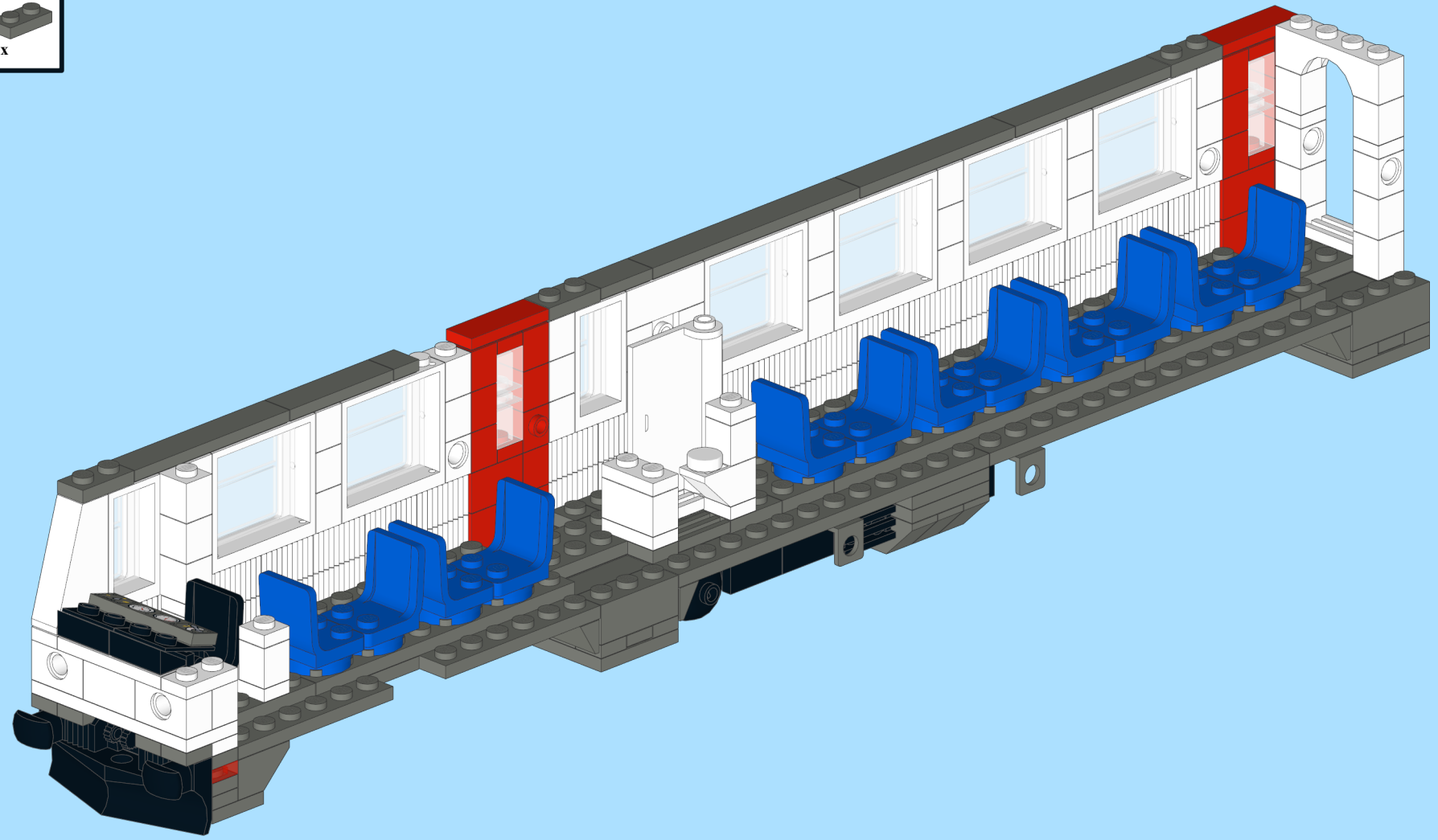
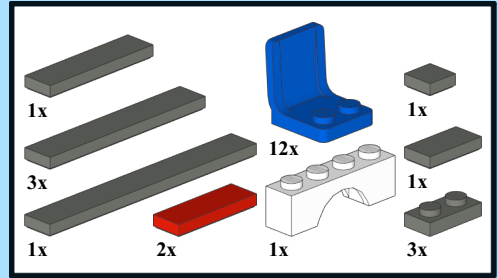

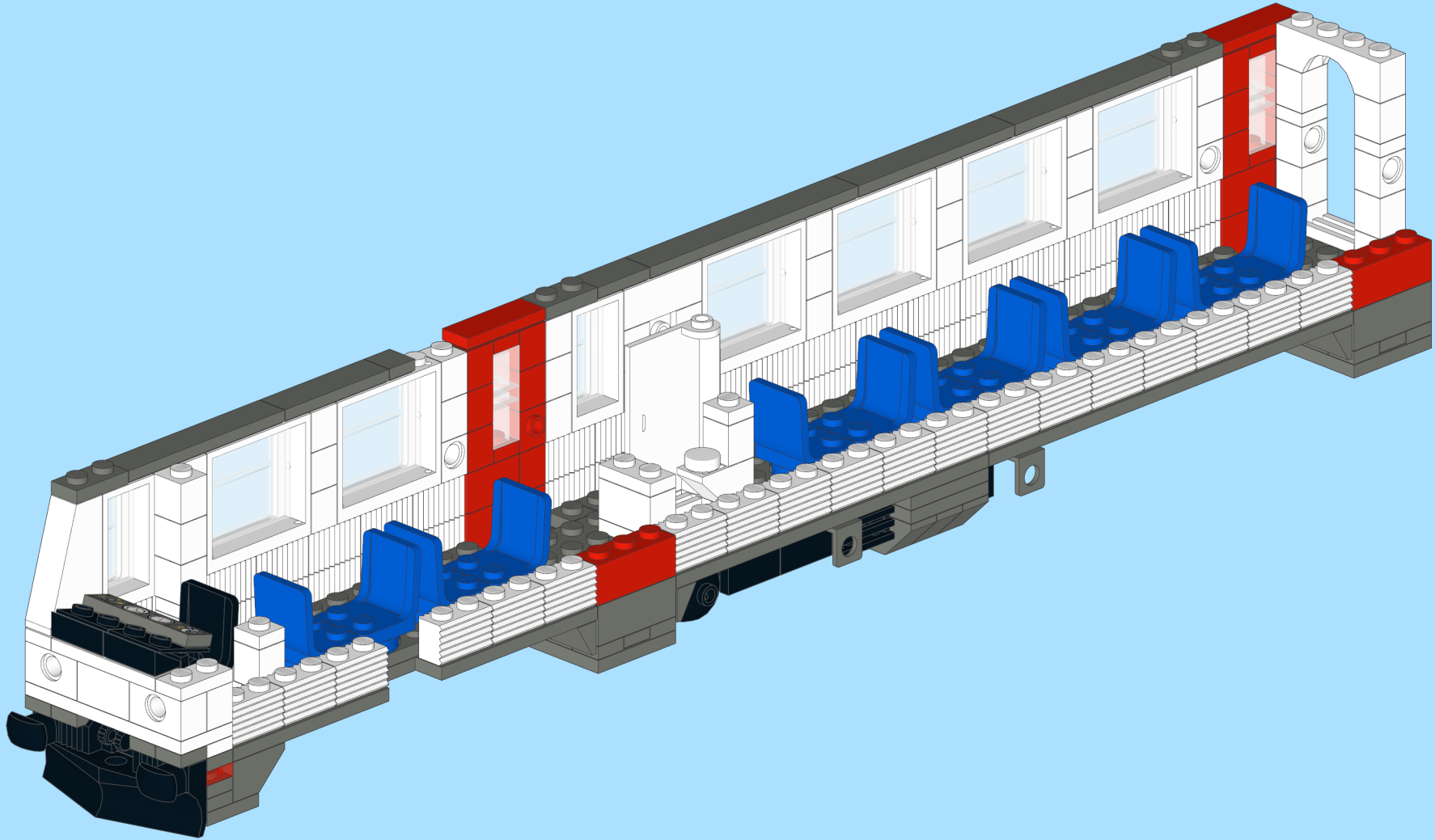
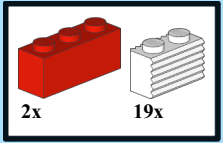

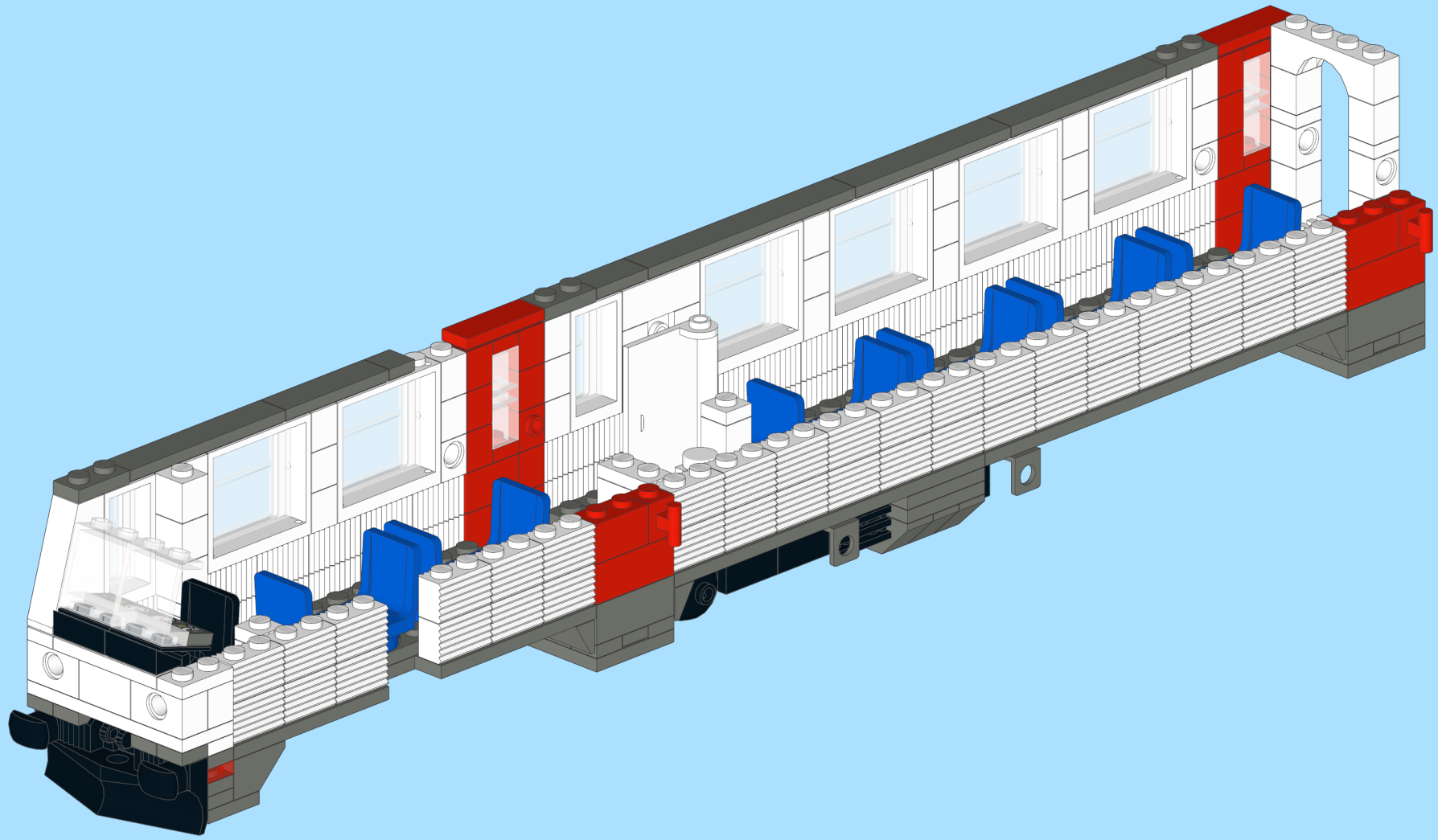
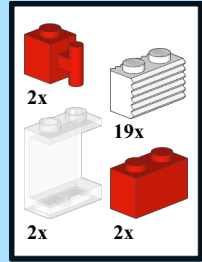

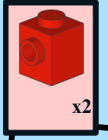
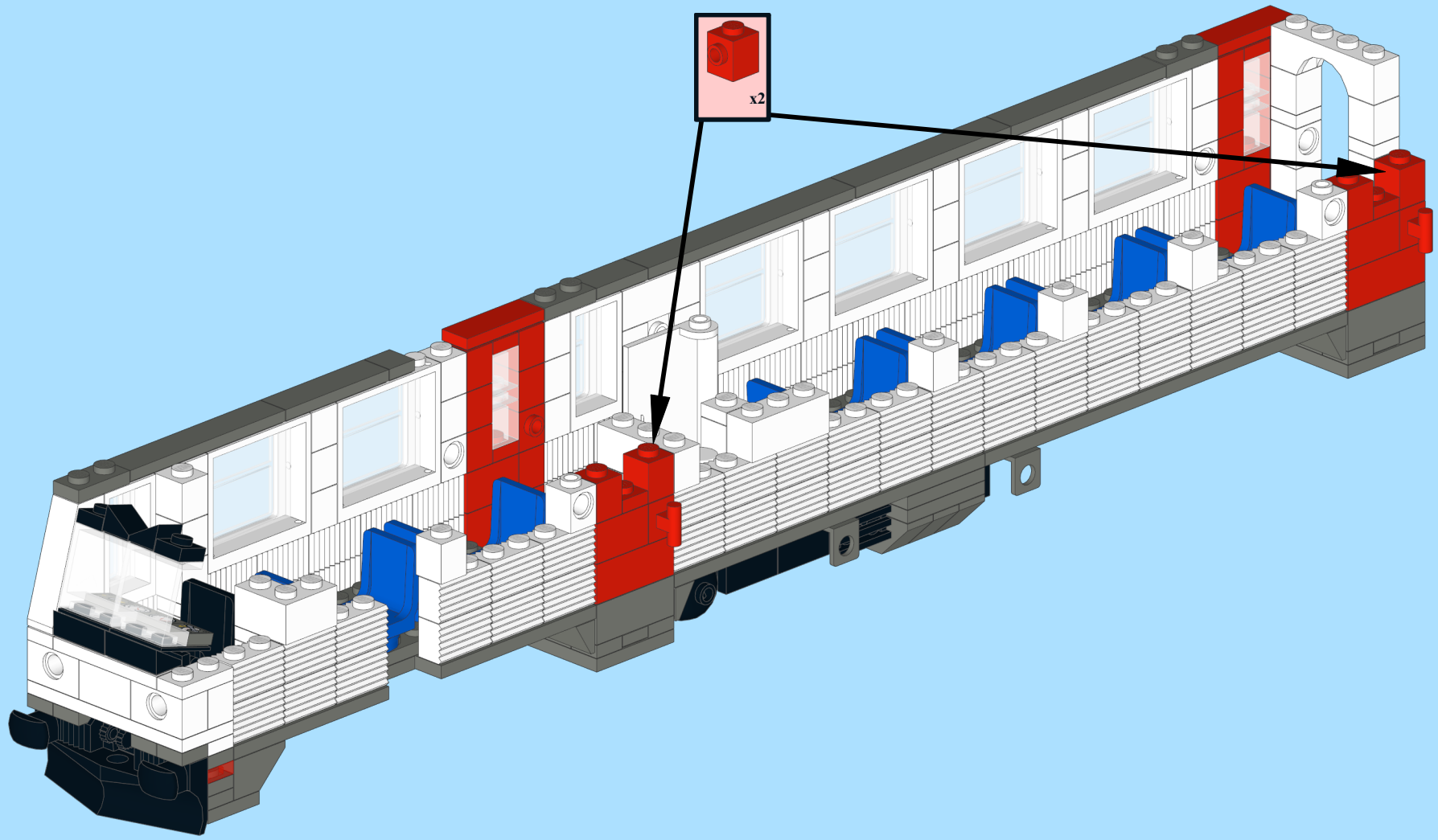
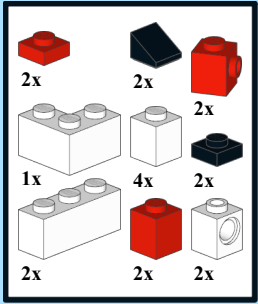

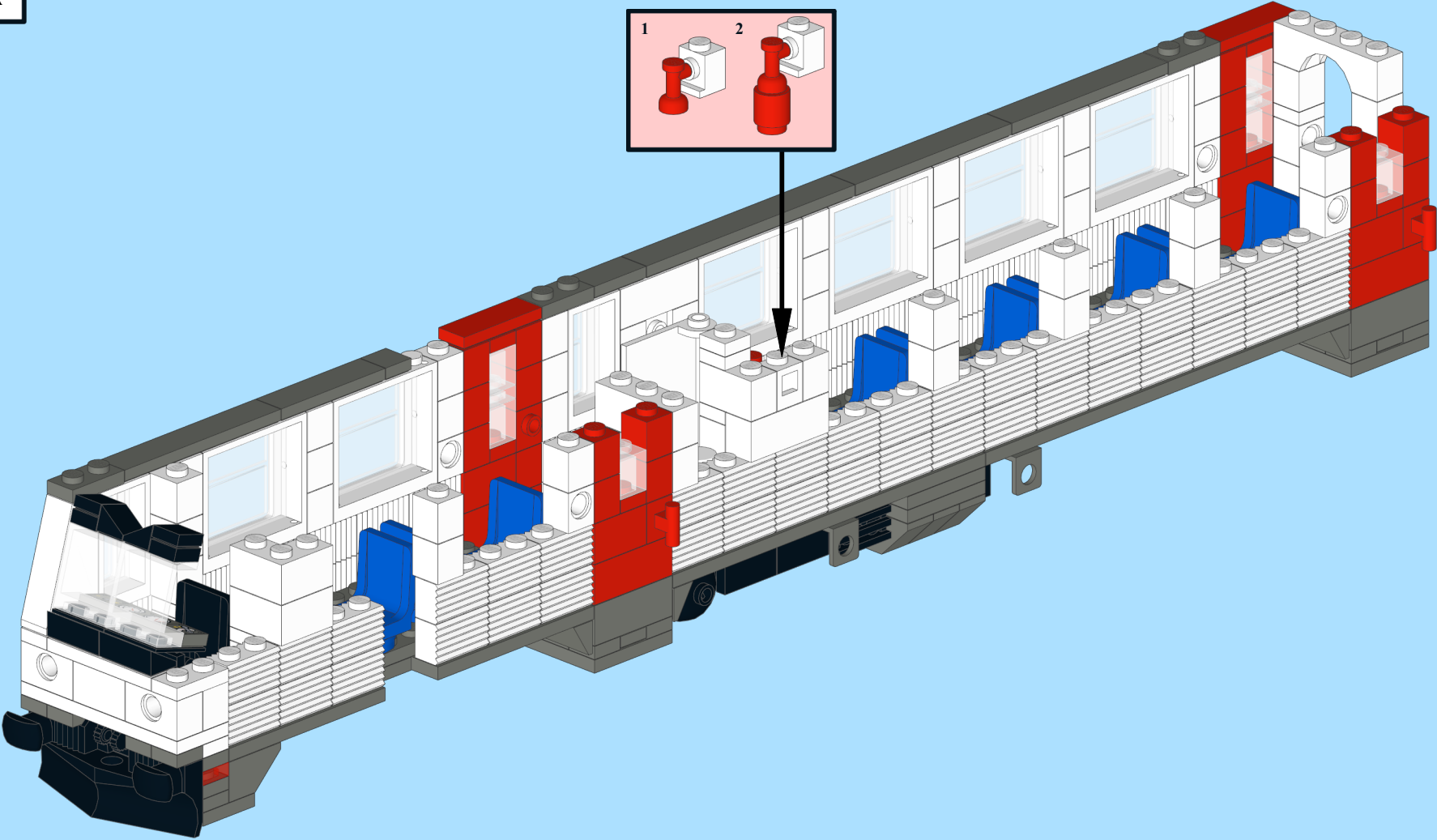
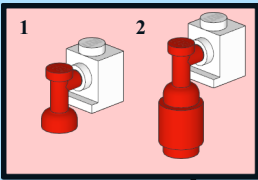
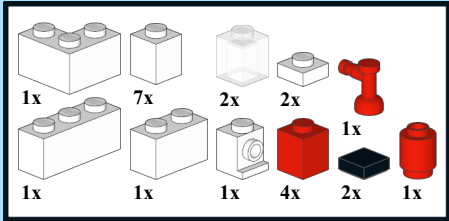

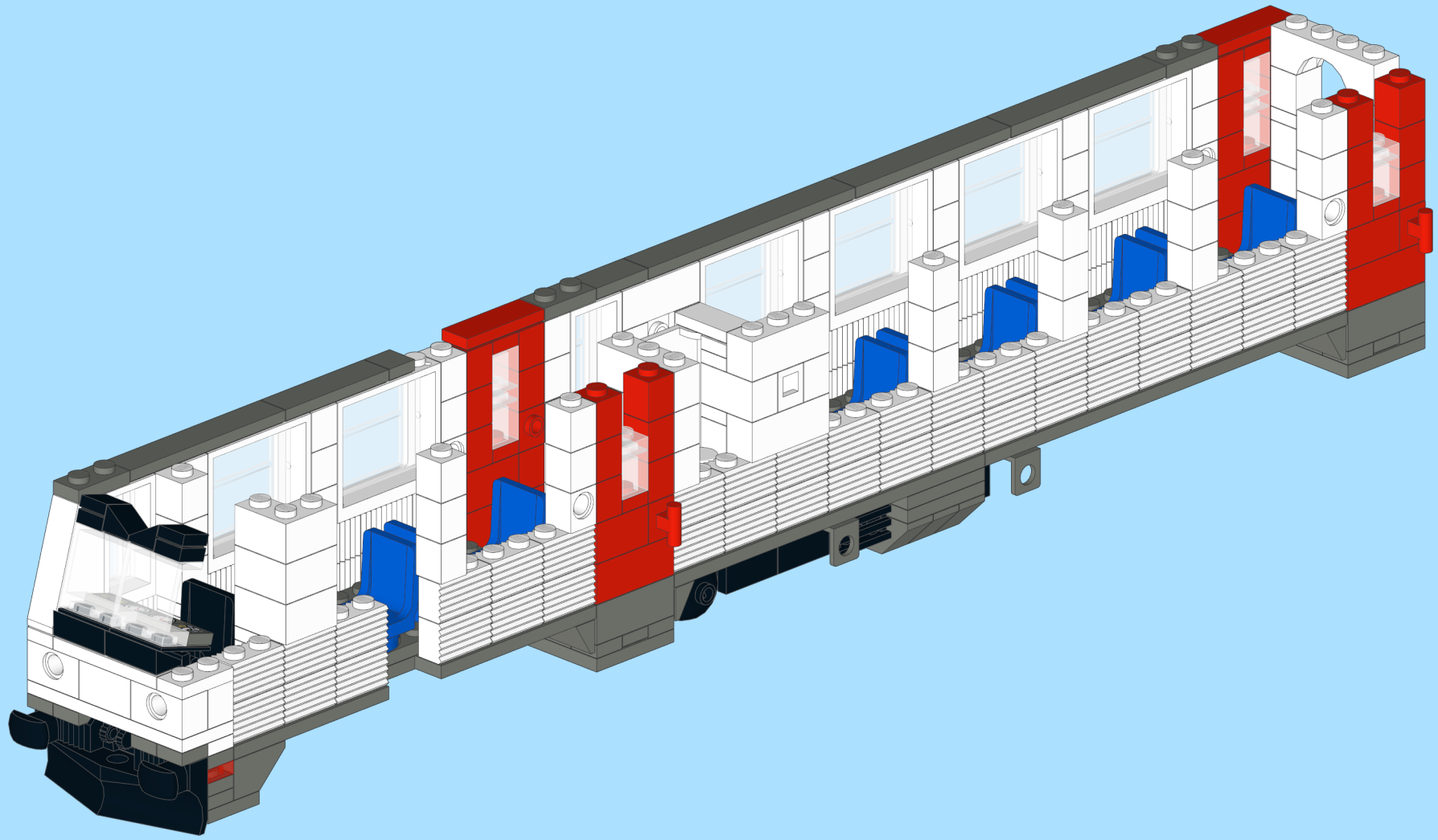
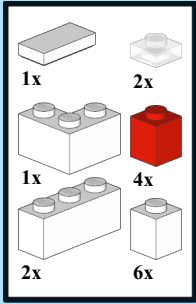

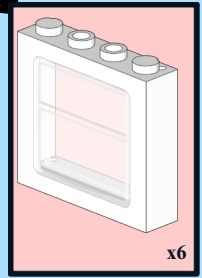
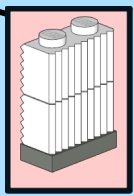
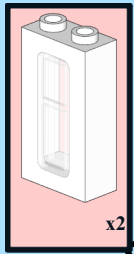
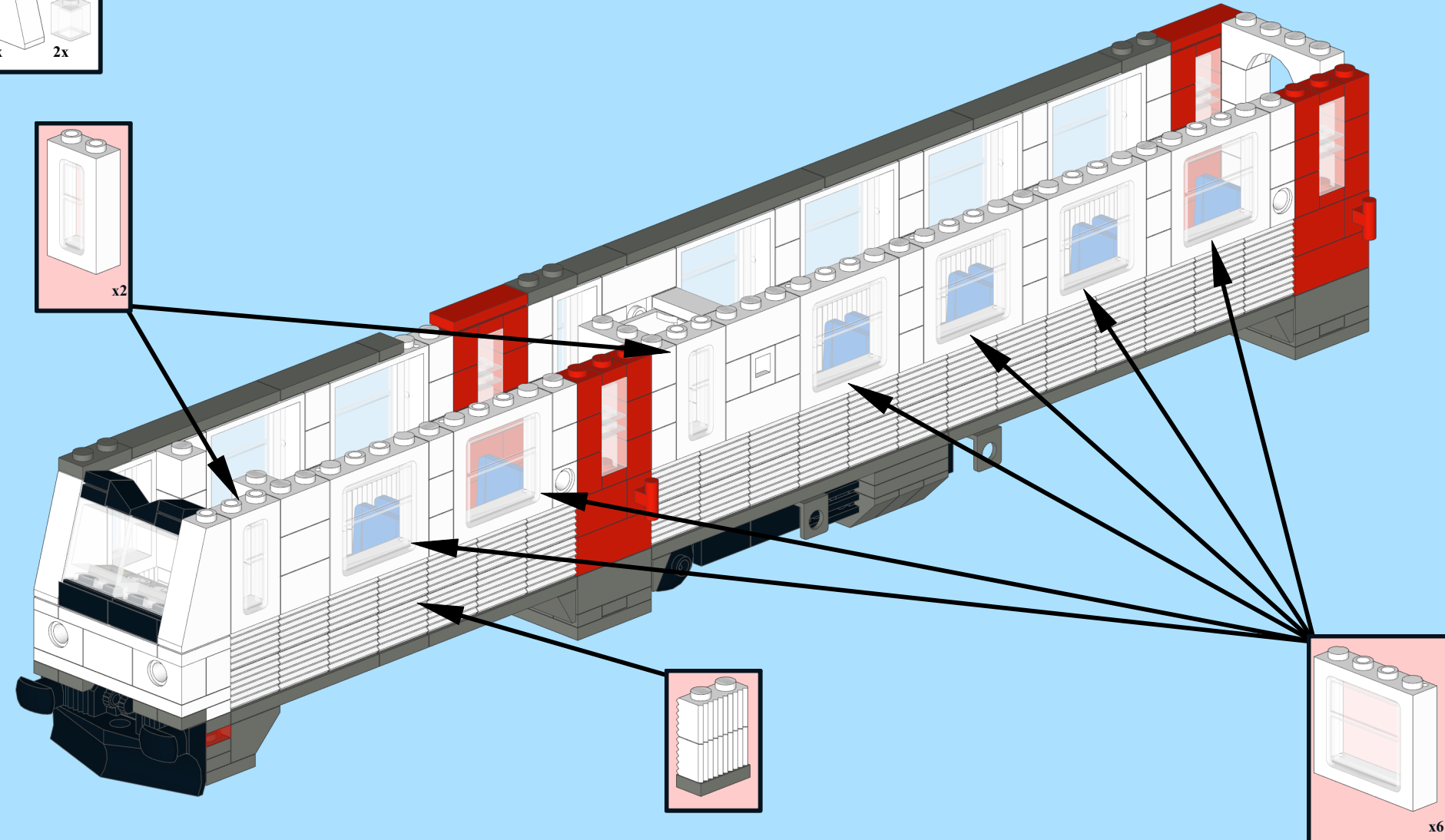
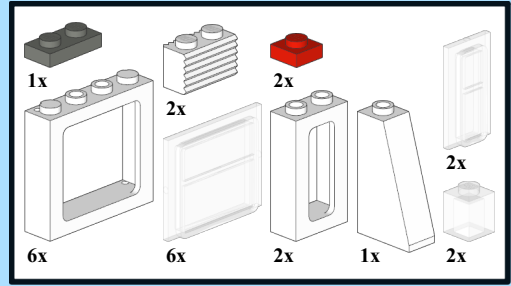

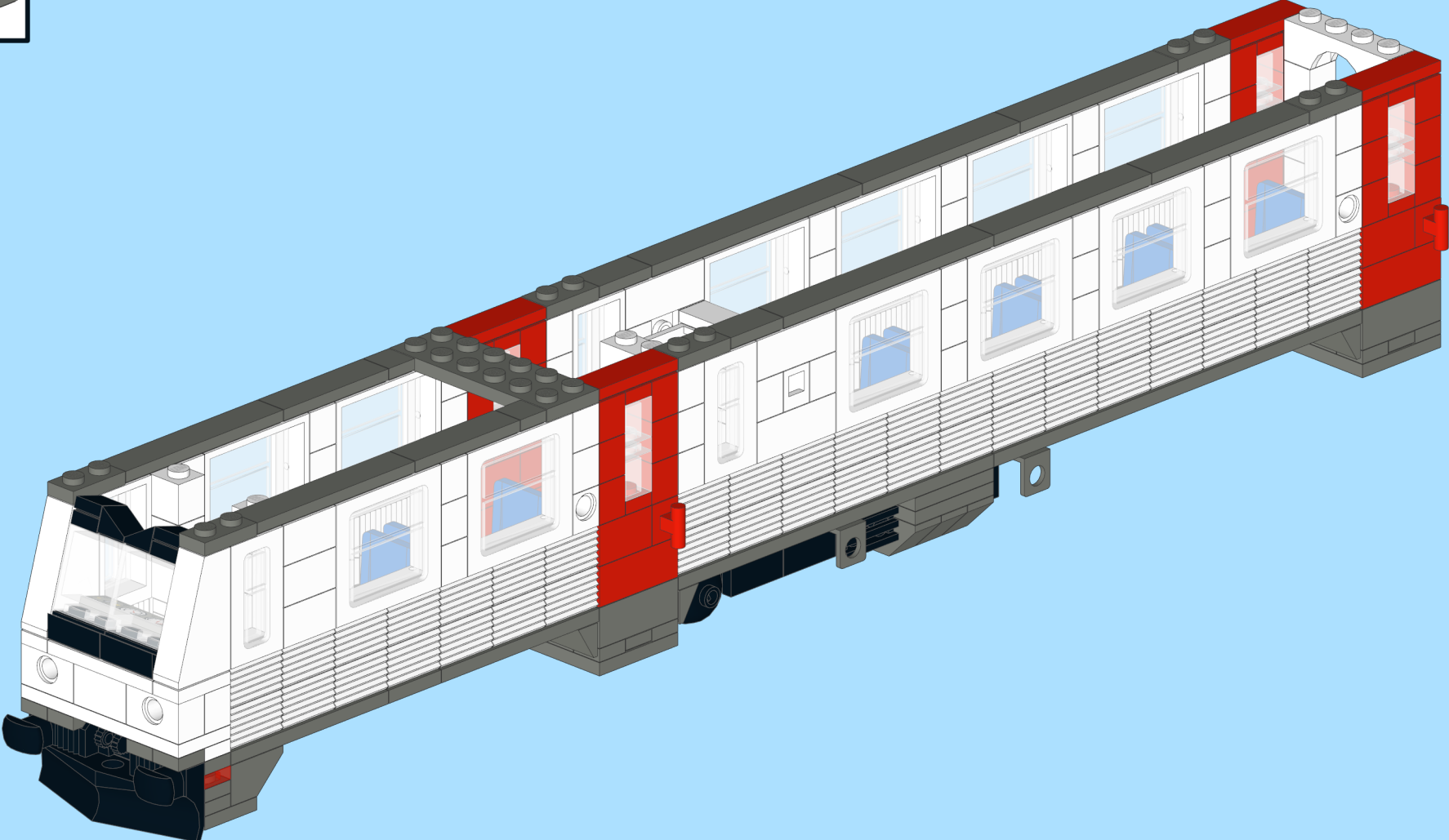
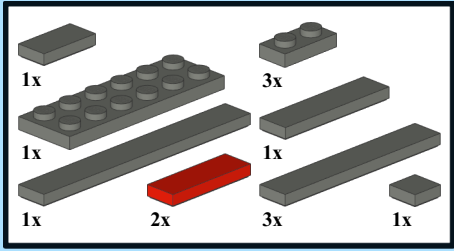

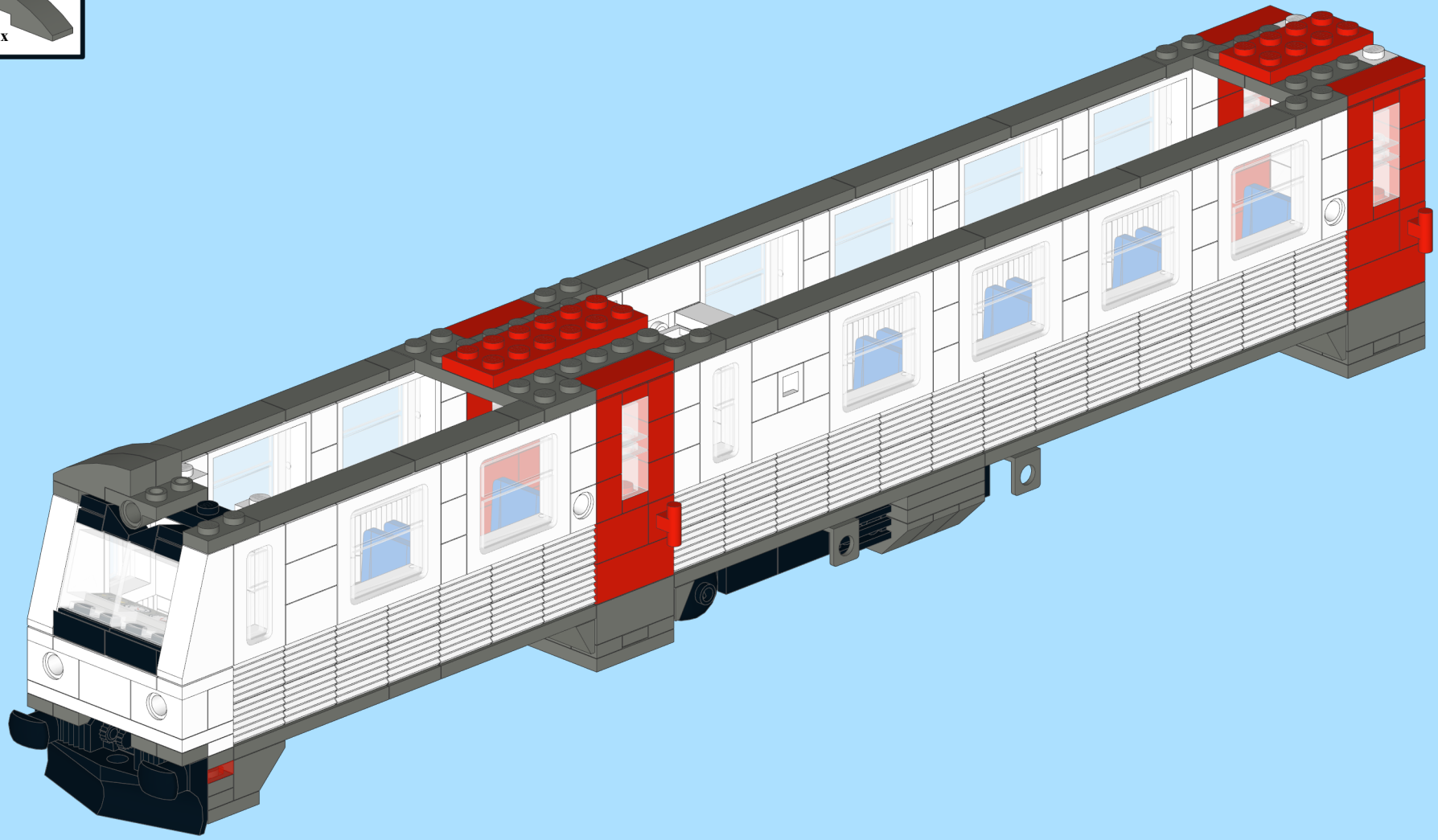
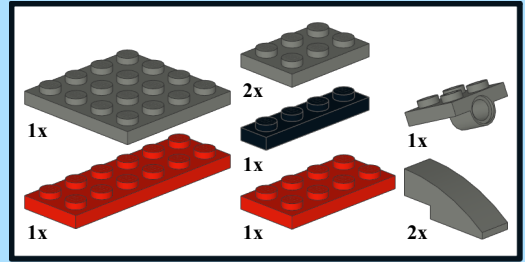

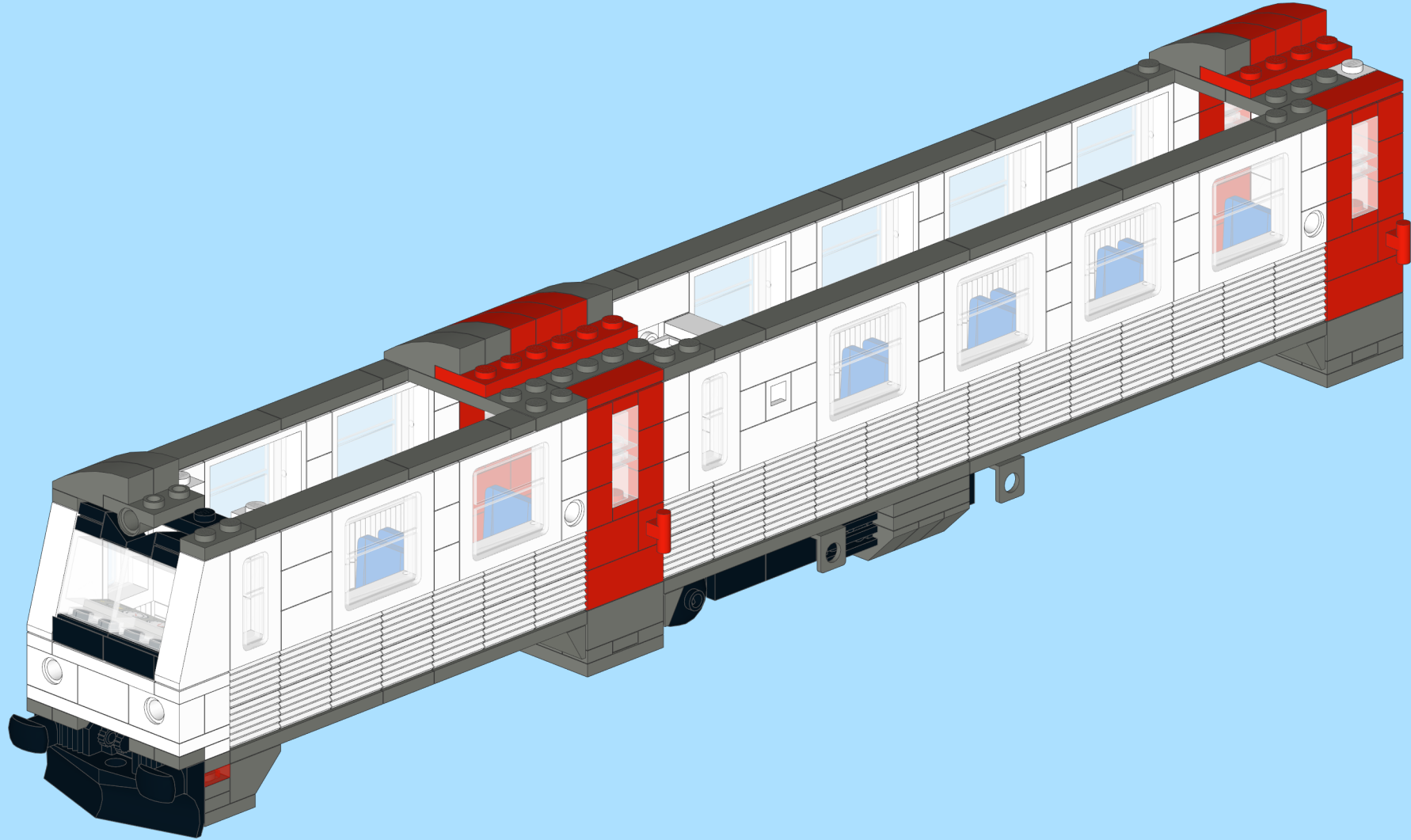
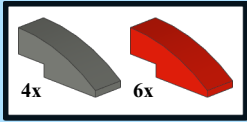

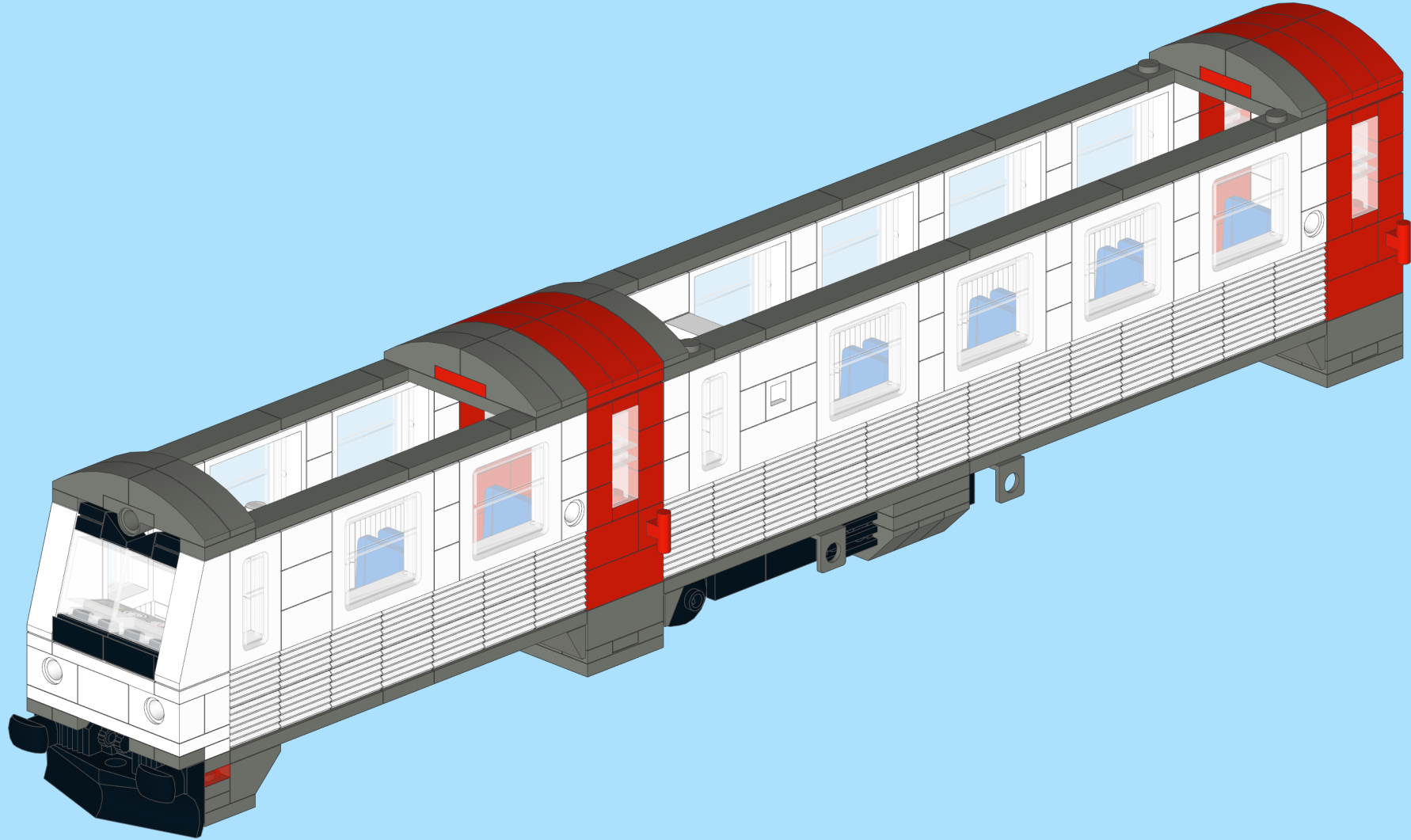
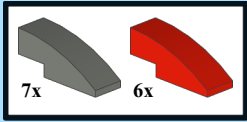







-  1x
-  1x
-  1x
-  1x
-  2x
-  2x

