

DSB Litra MZ (III)

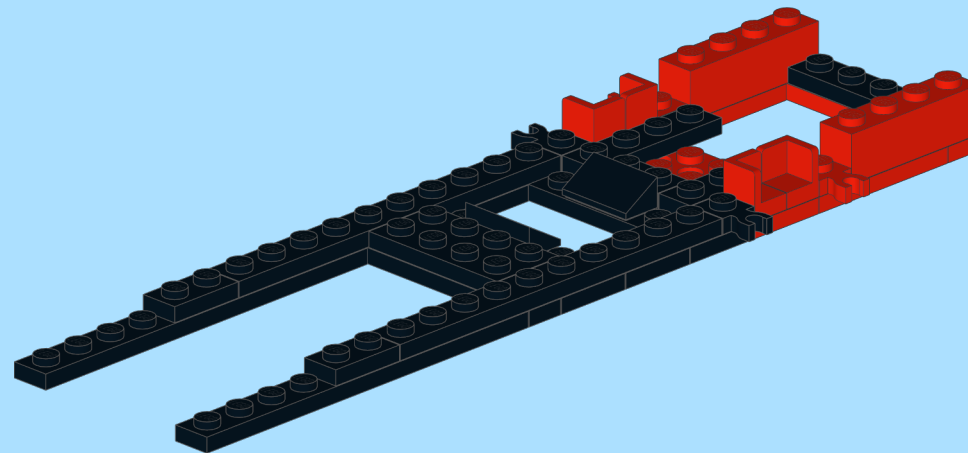

Design by Dennis Tomsen
At Byggepladen.dk
Updated 2018-09-17

INSTRUCTION BY
KNUD ALBRECHTSEN
www.snakebyte.dk/lego

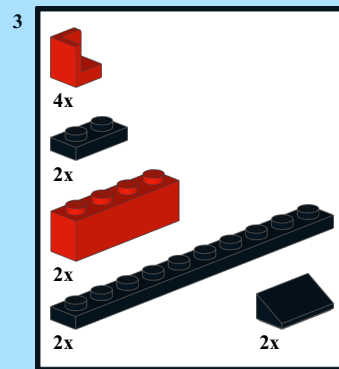
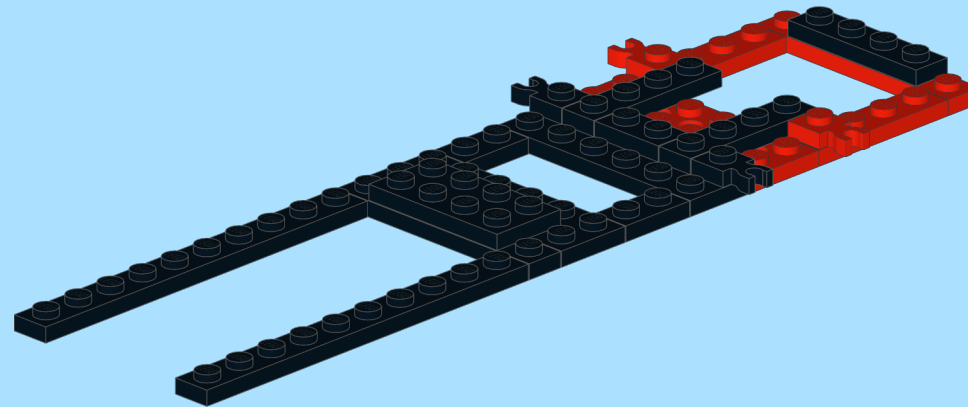
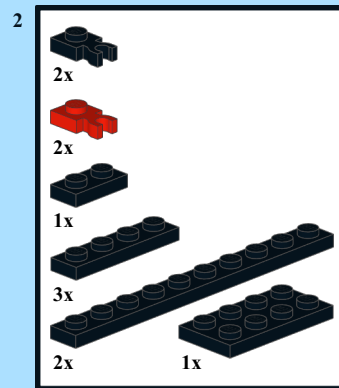
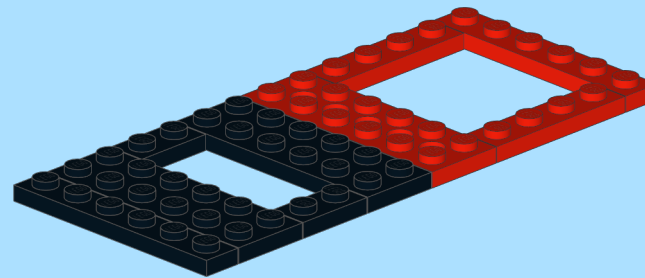
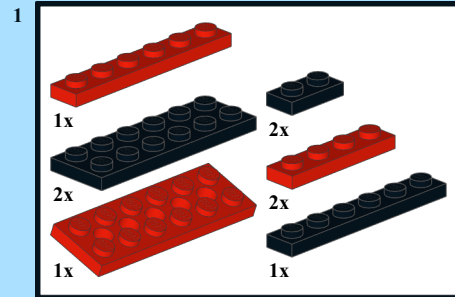

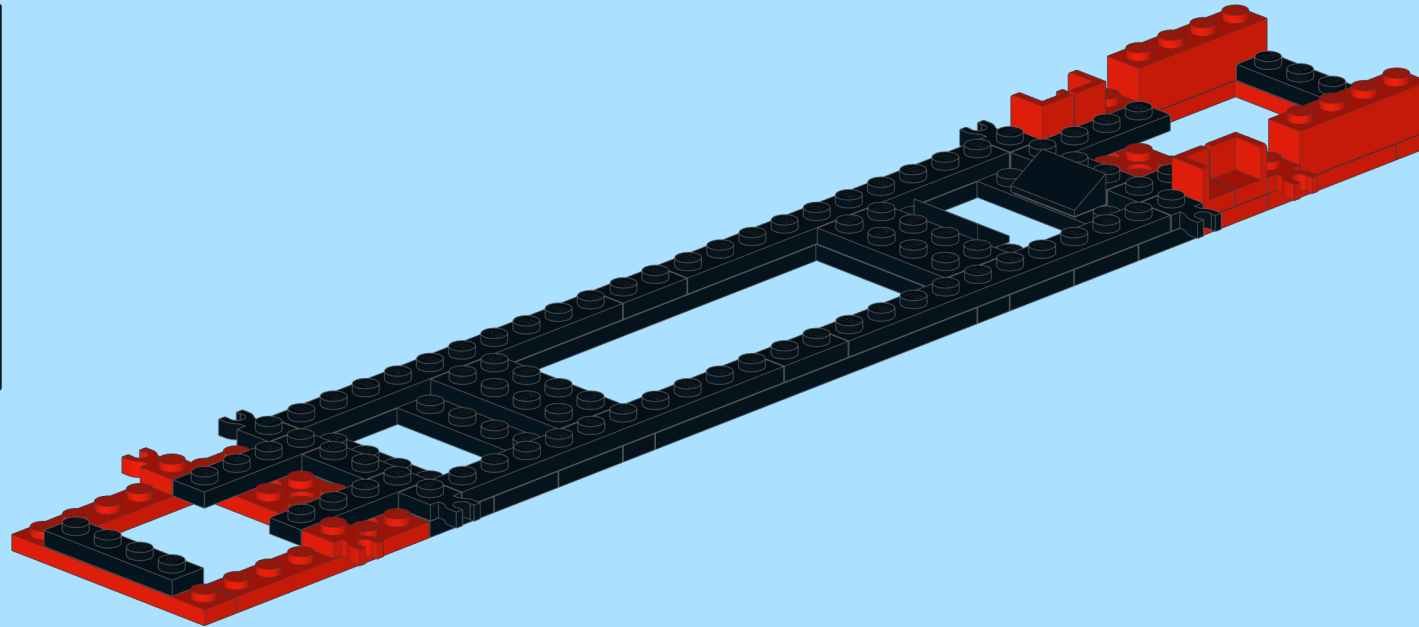
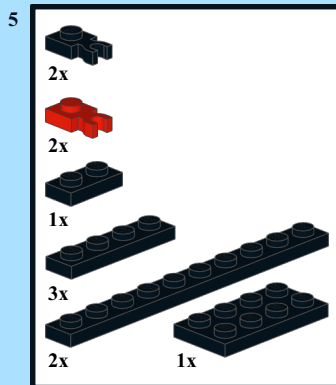
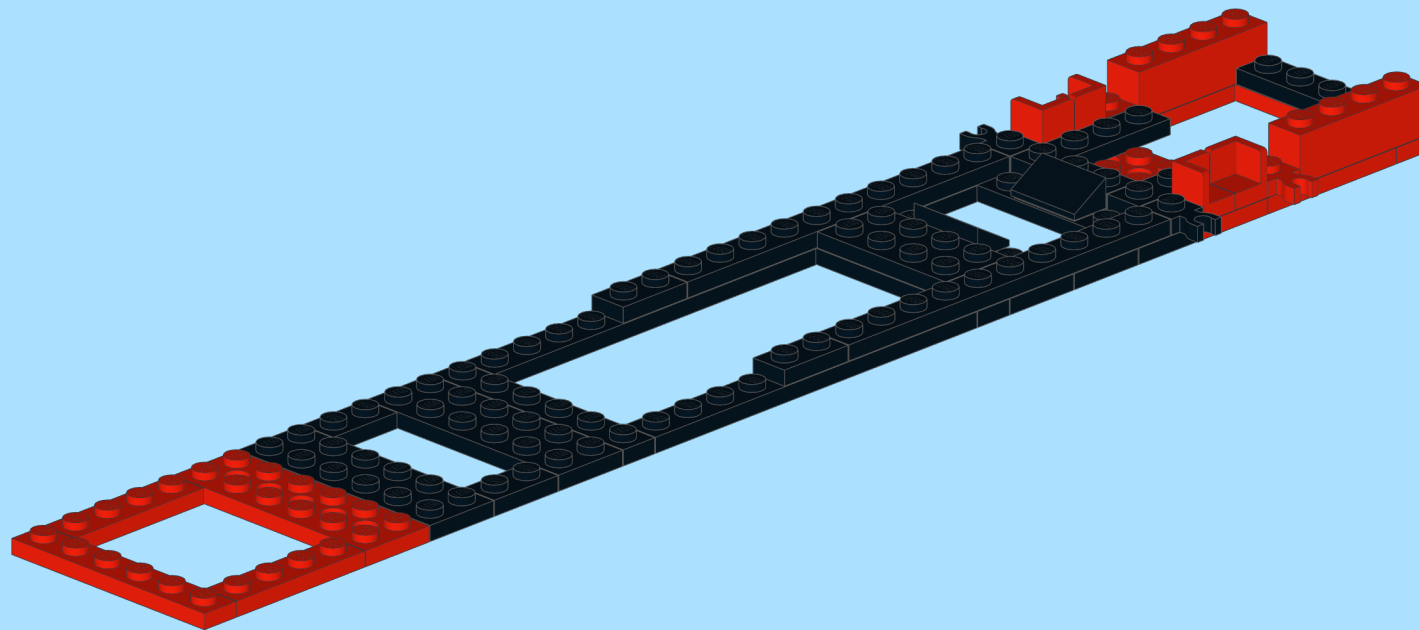
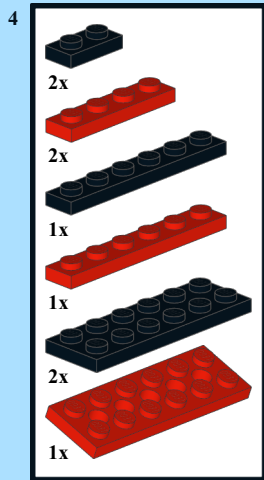

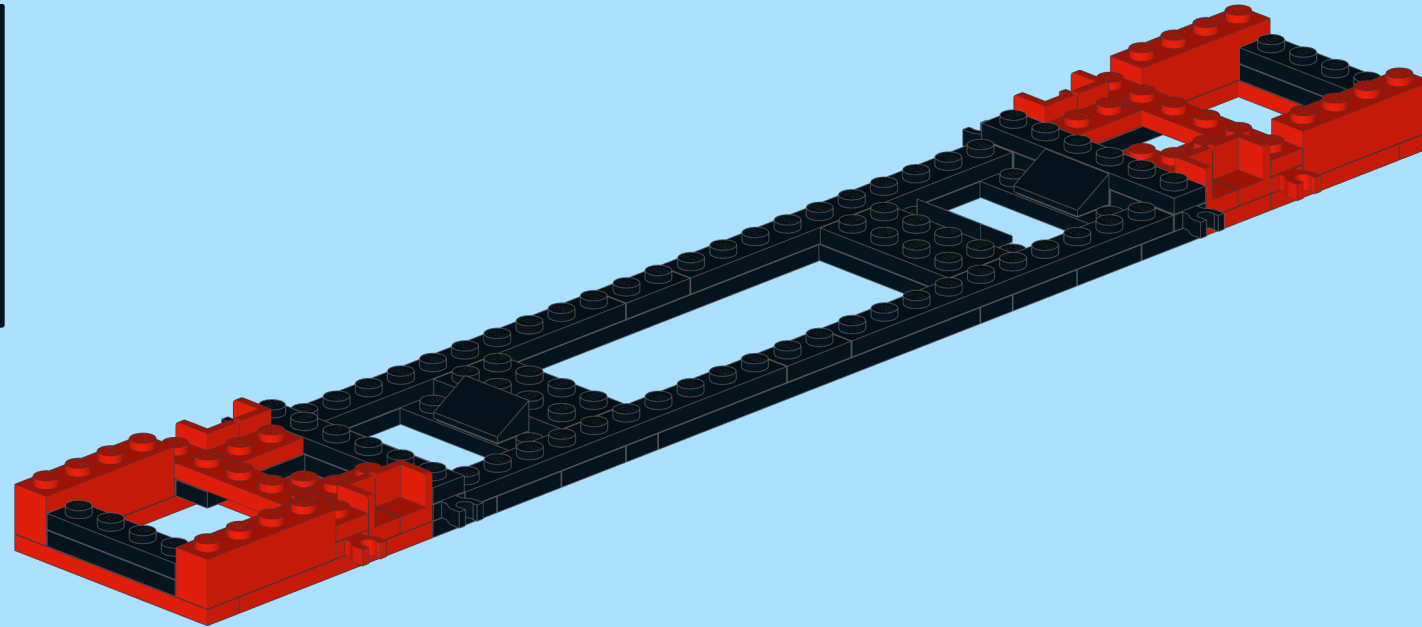
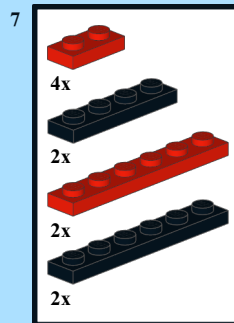
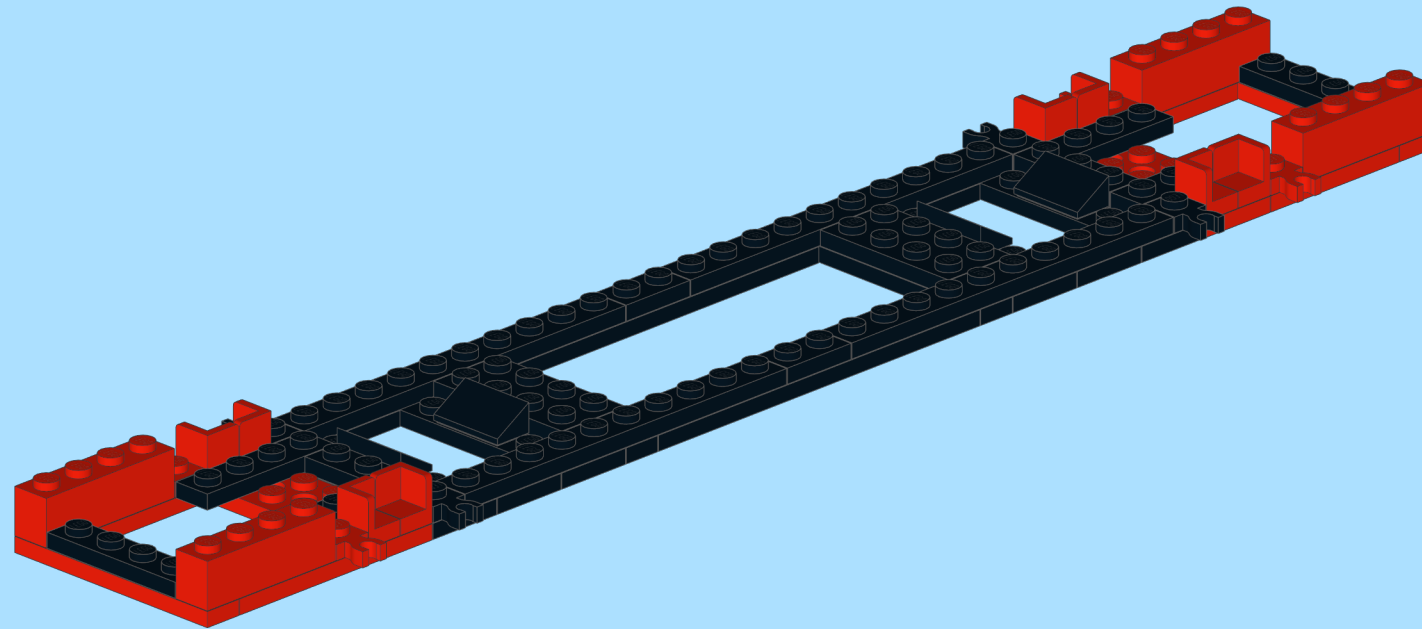
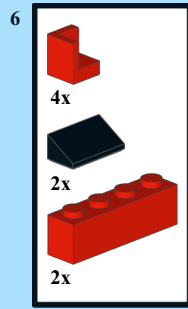

8

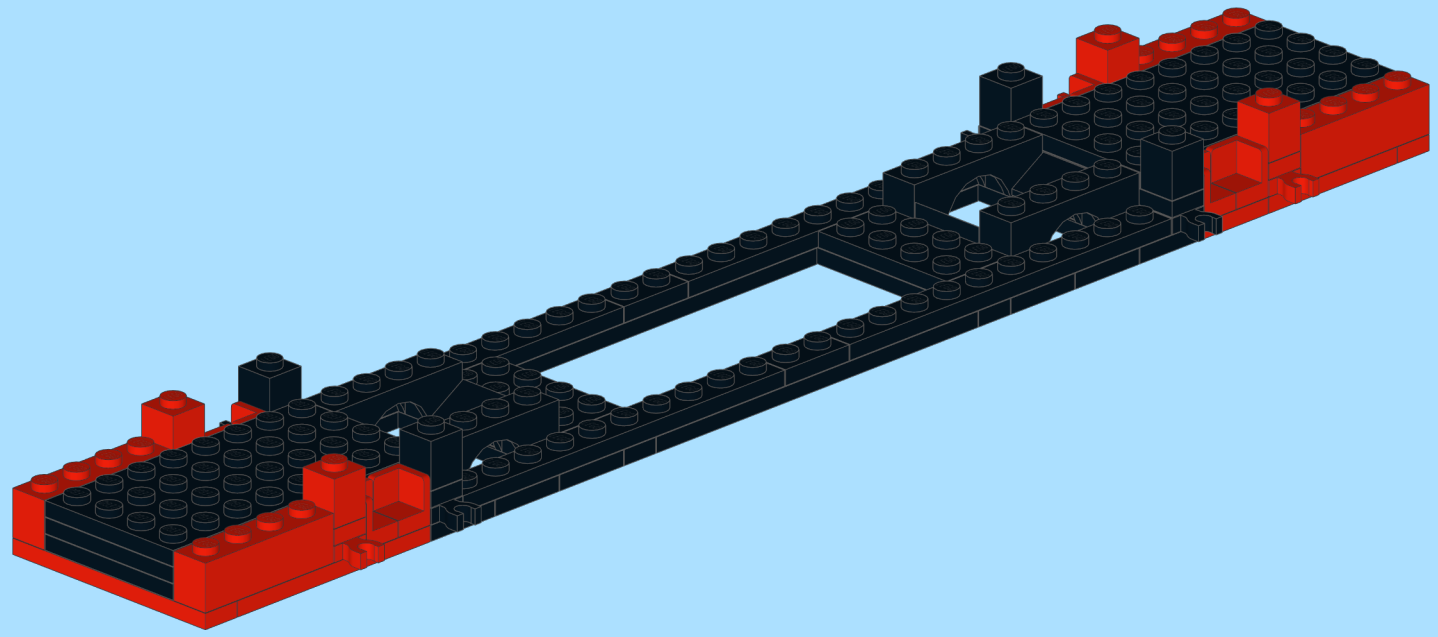
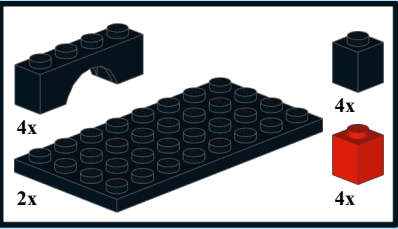

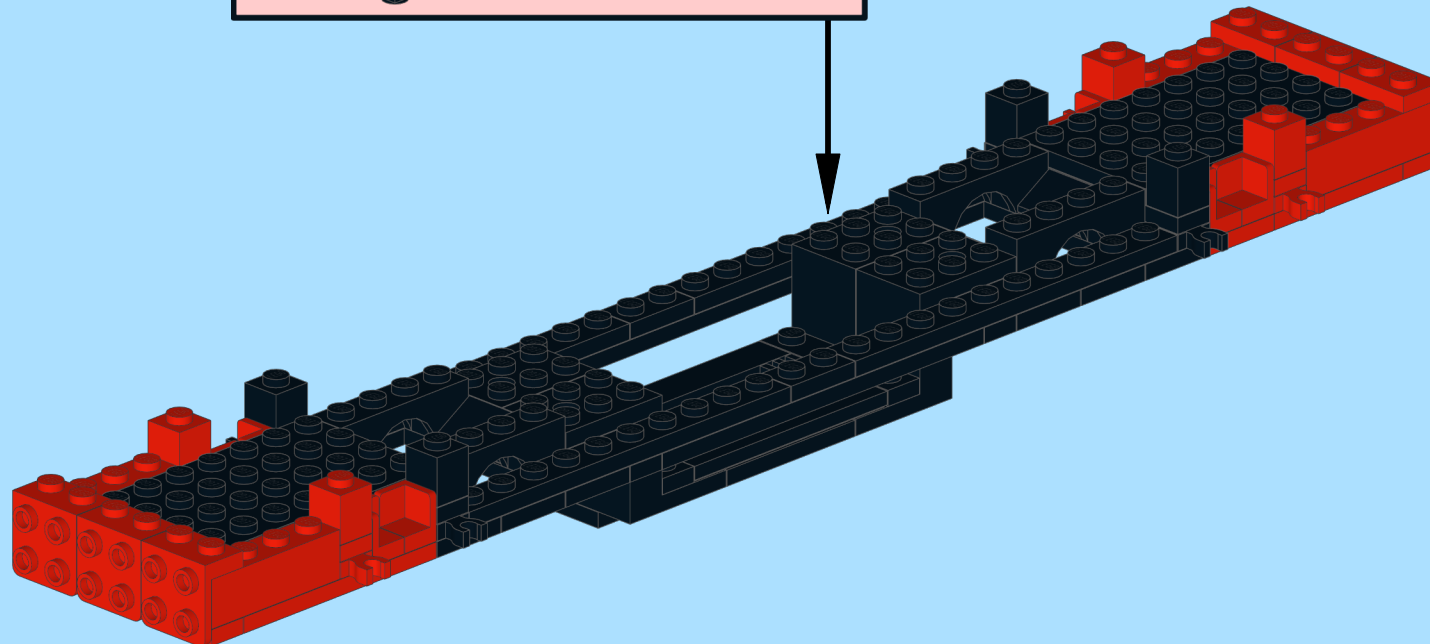
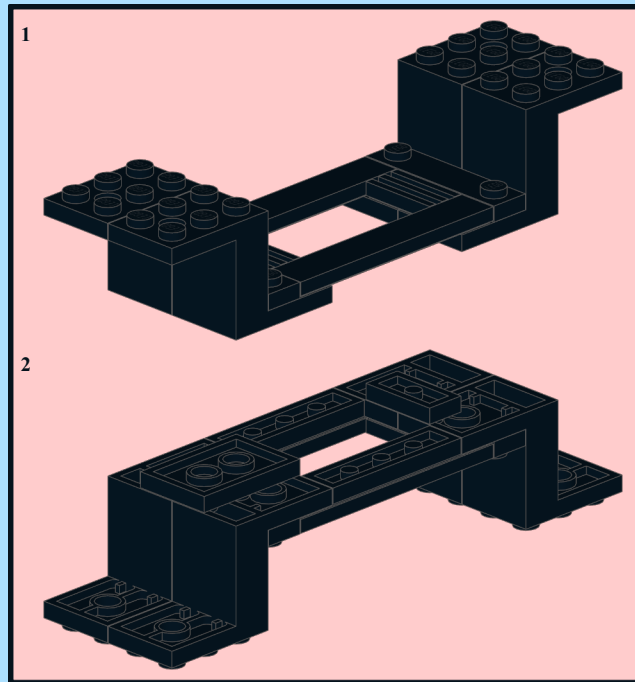
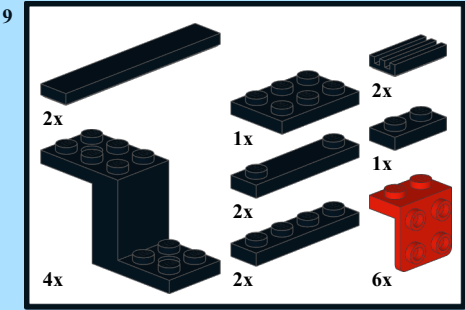



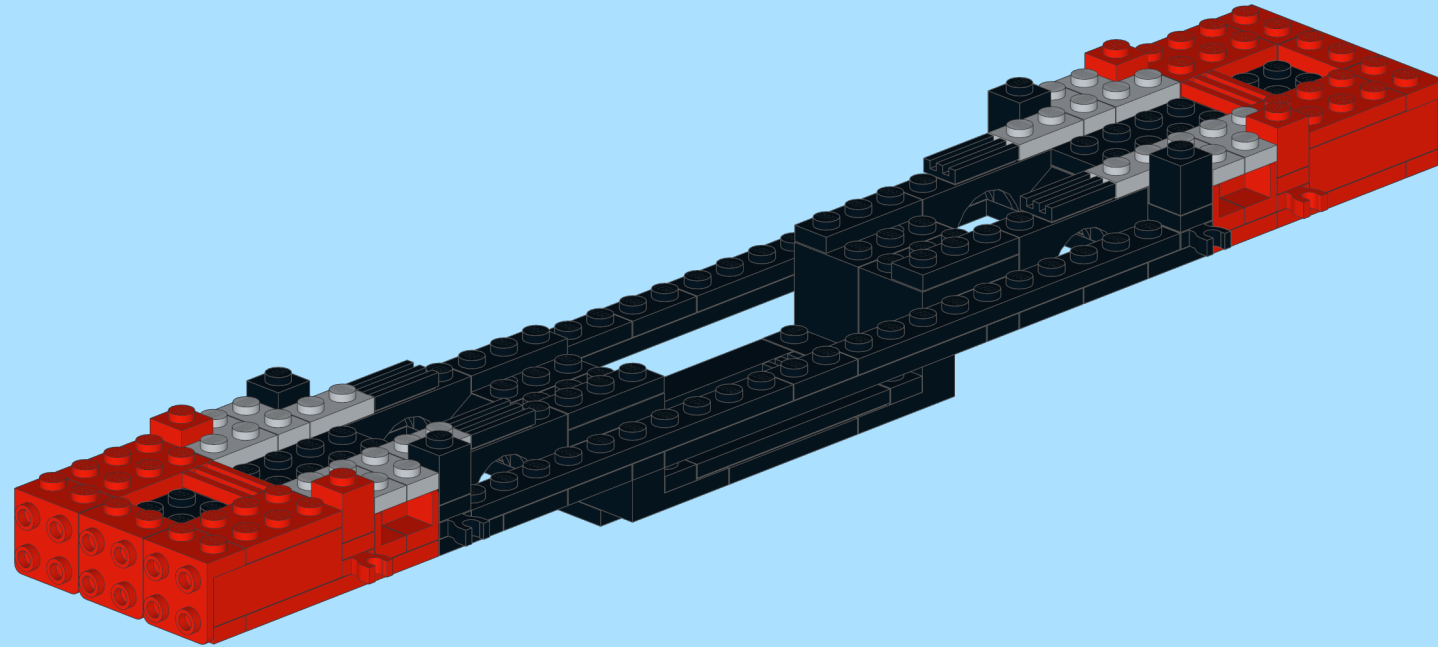
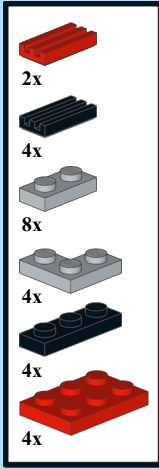

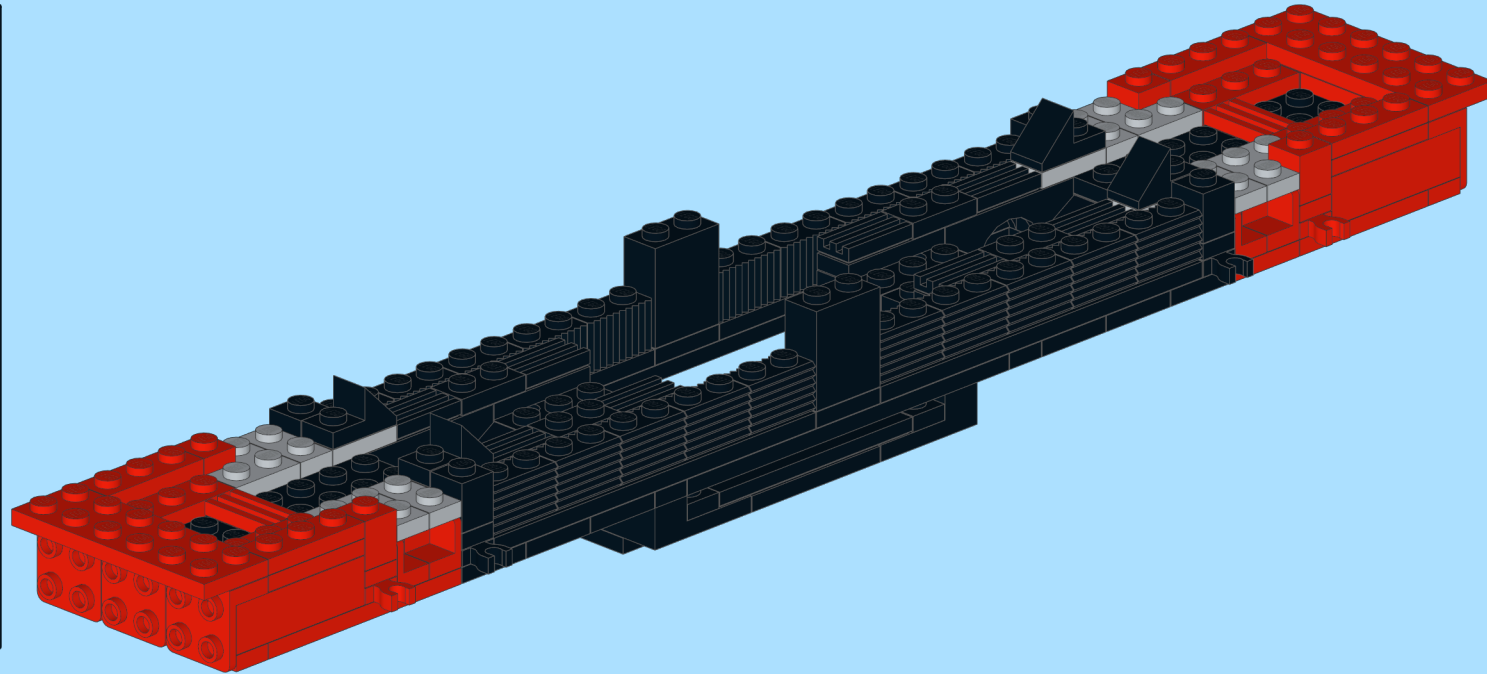
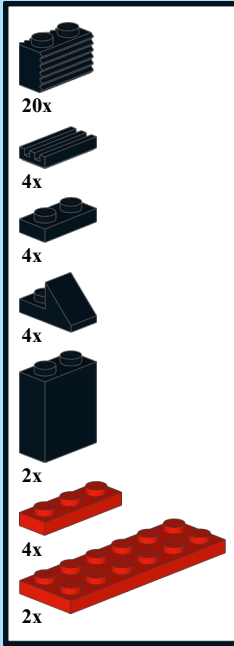

10







11

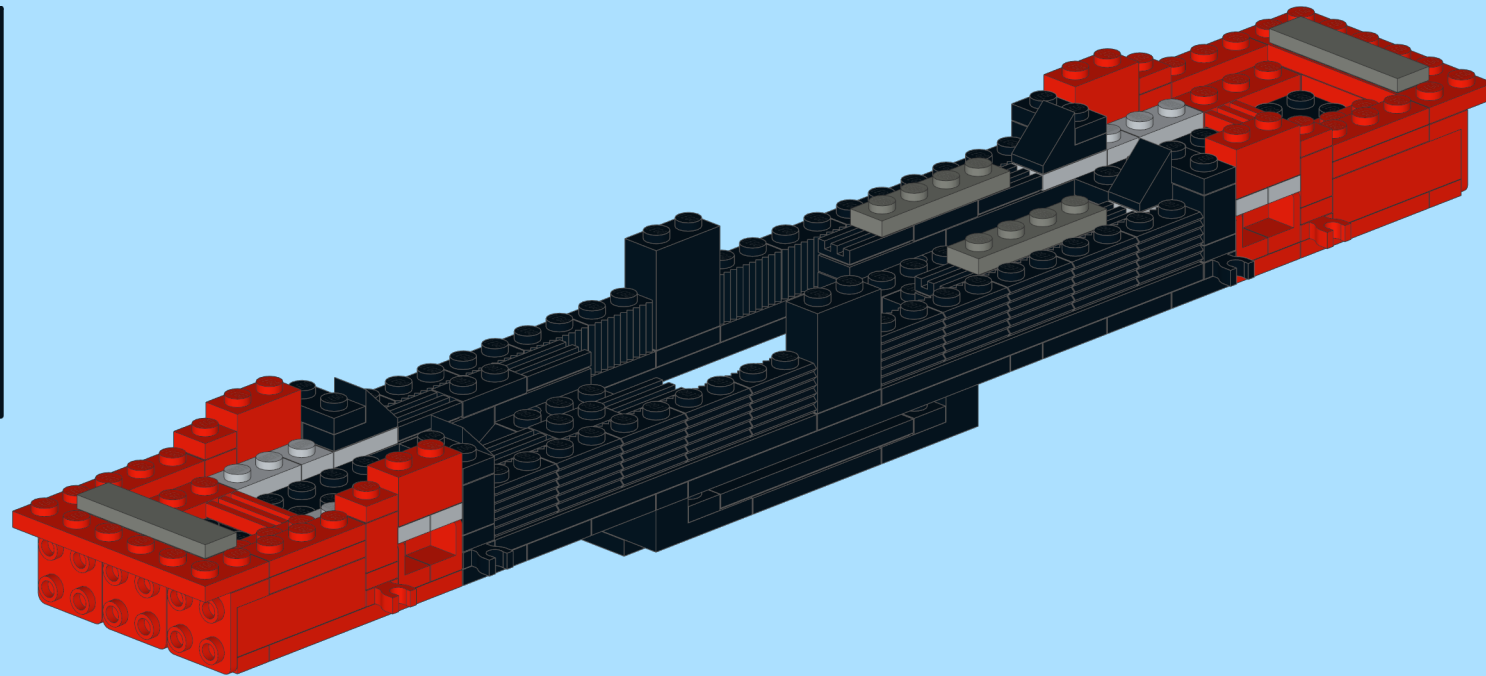

- 12
-  4x
 -  4x
 -  4x
 -  4x
 -  2x
 -  2x



- 13
-  4x
 -  4x
 -  4x
 -  2x
 -  2x

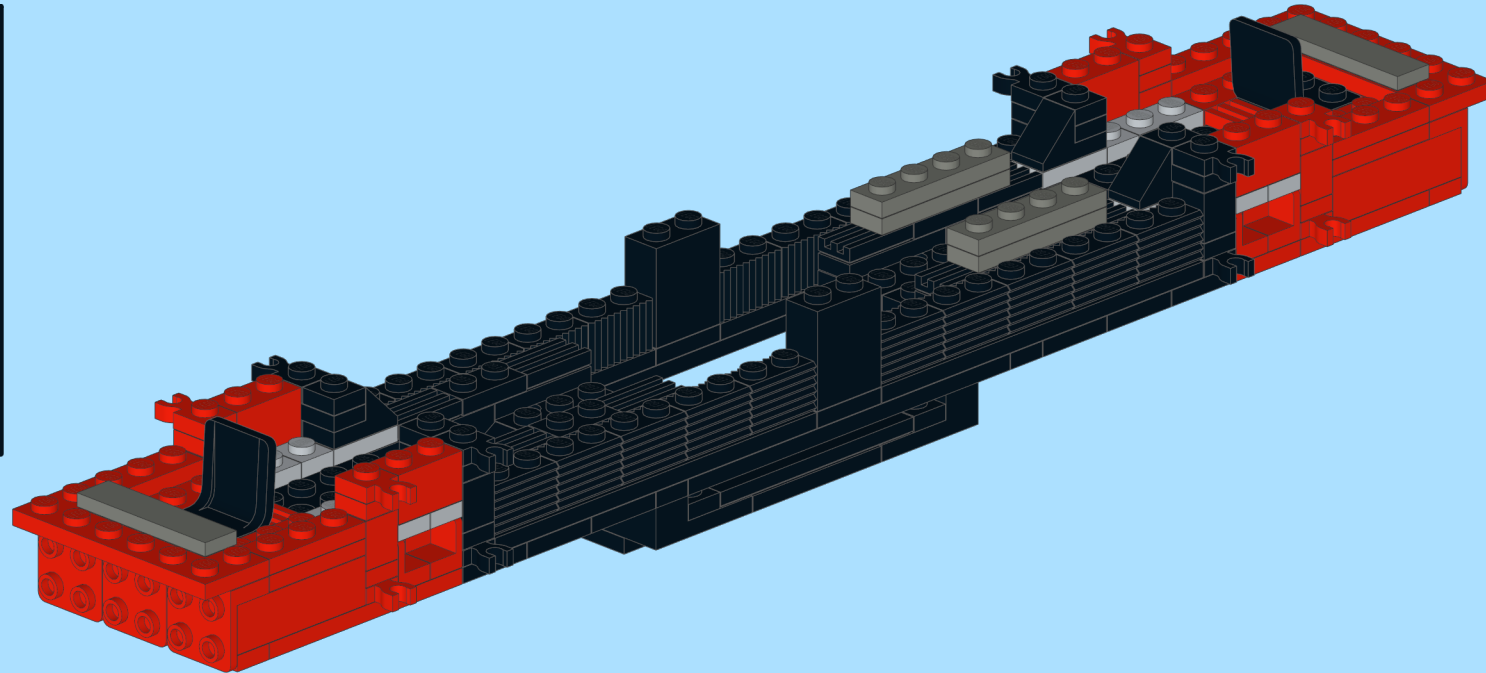

14

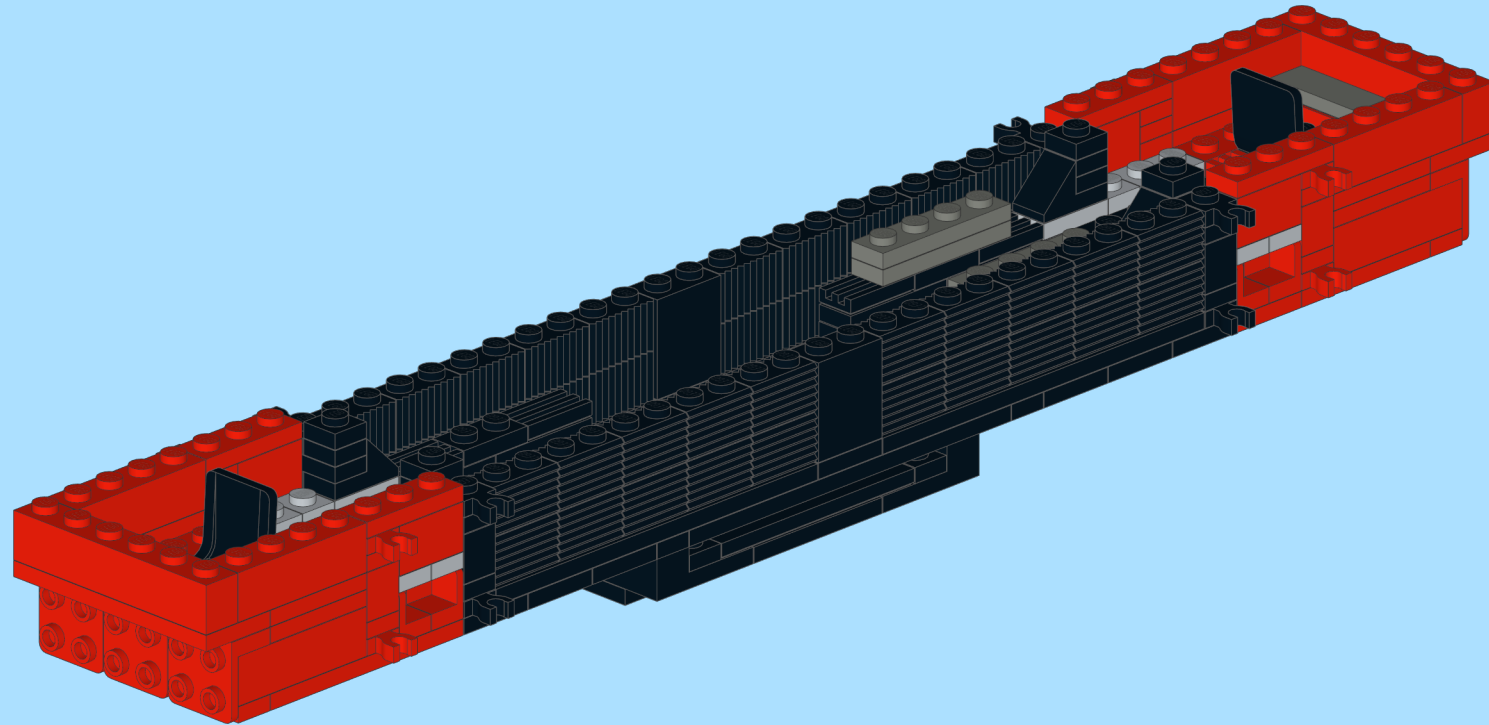
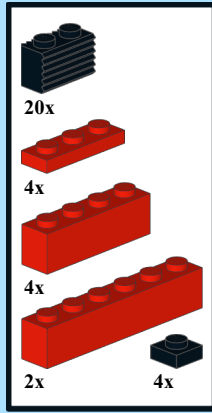

15

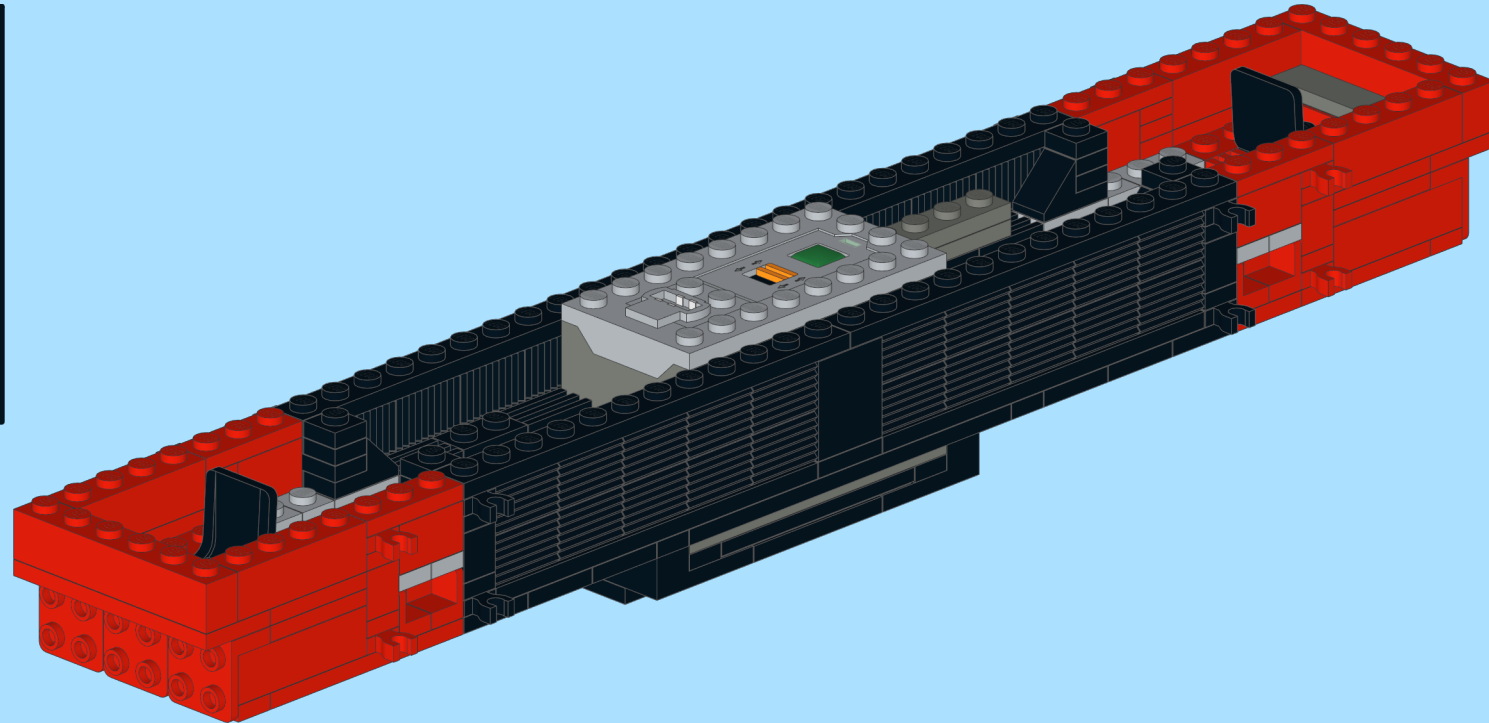
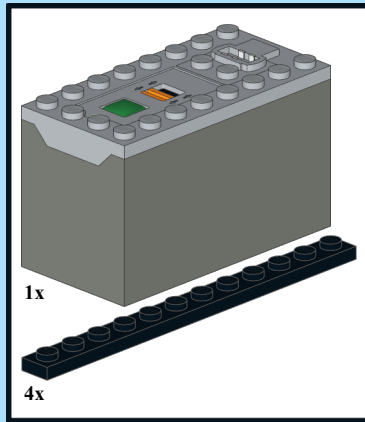

16

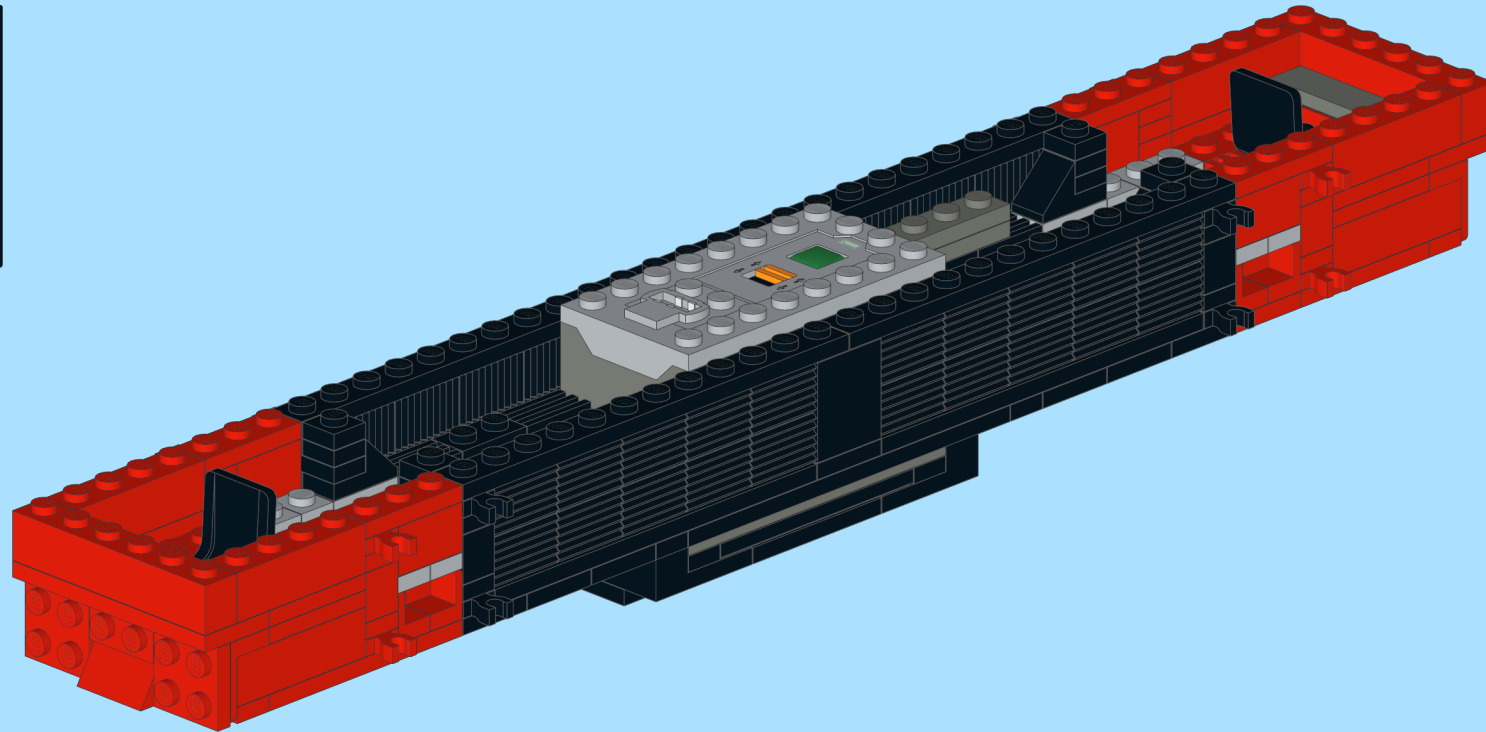
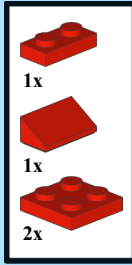

17

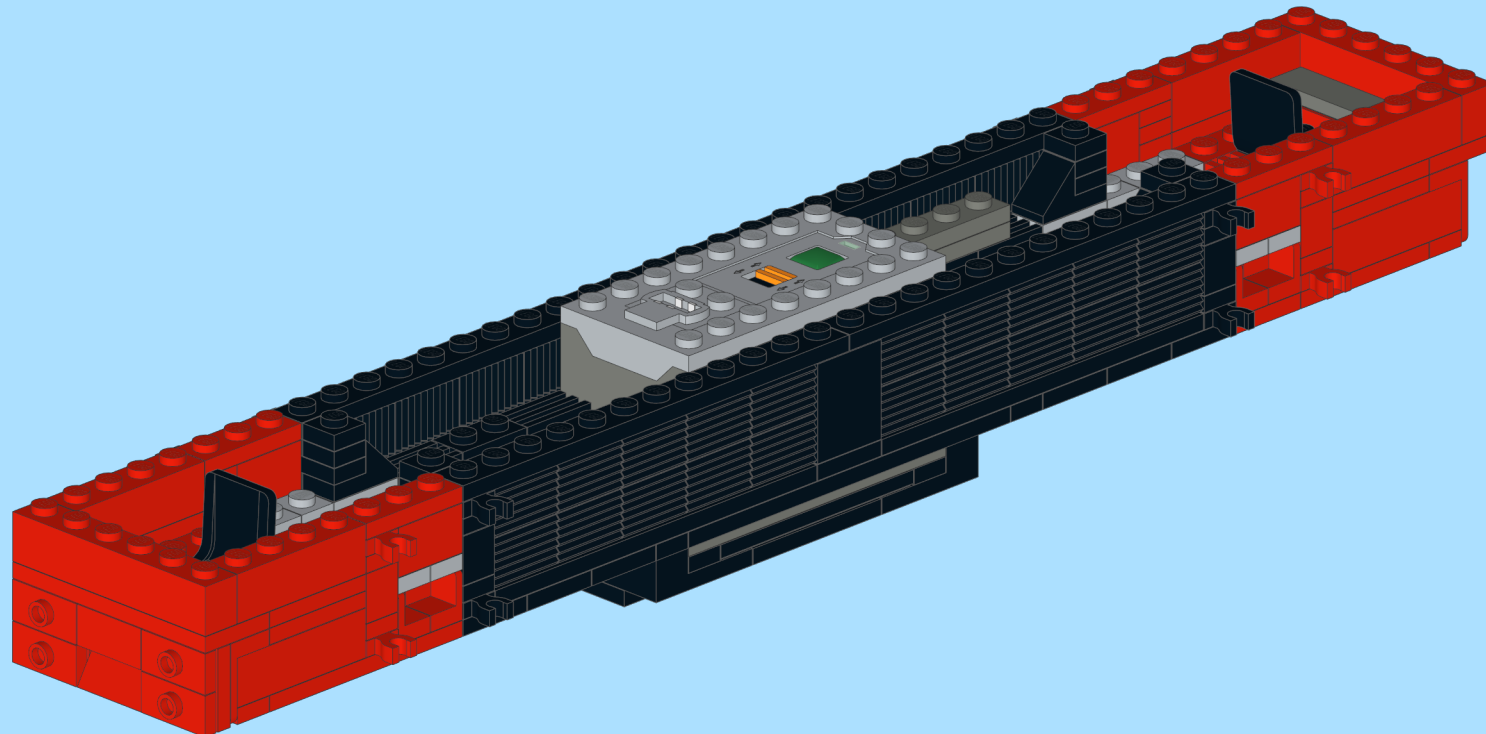
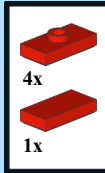

18

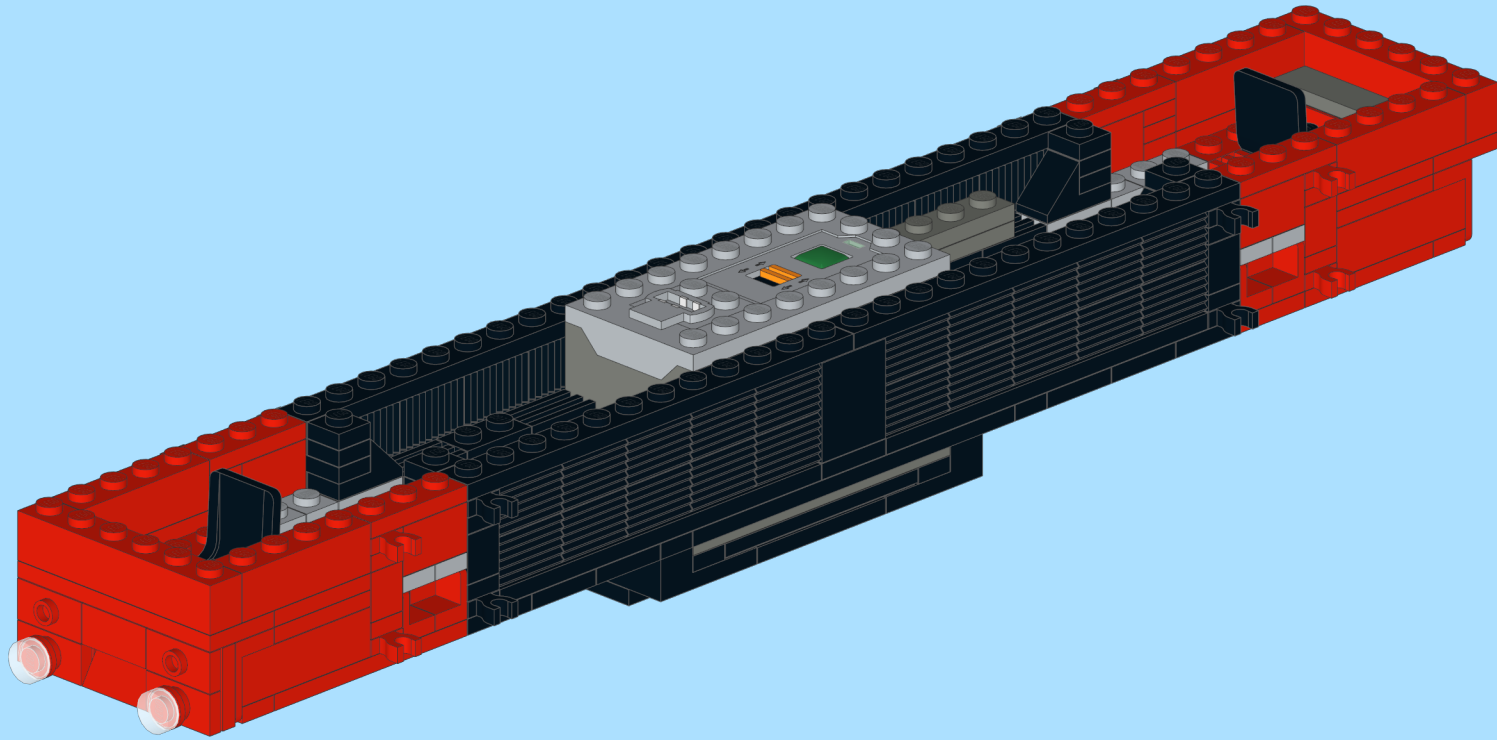

19

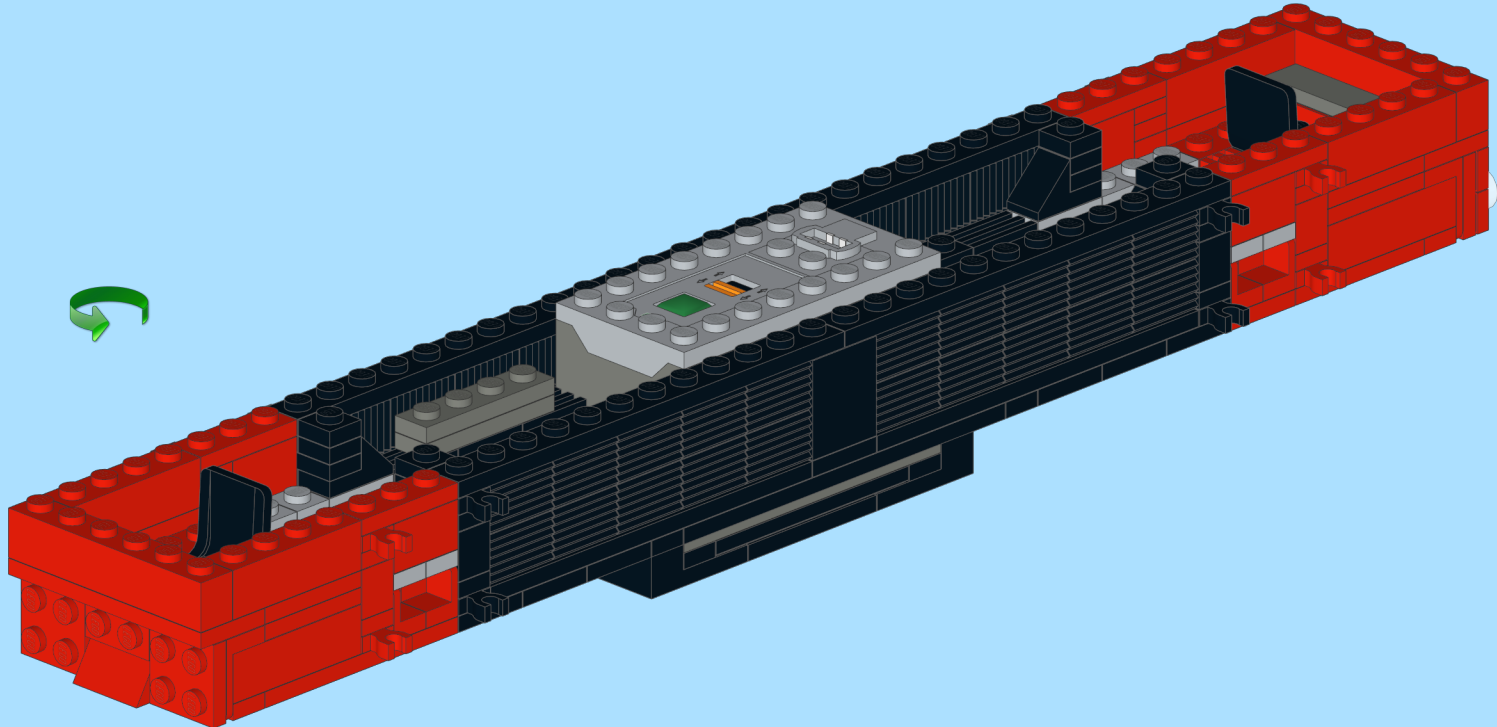
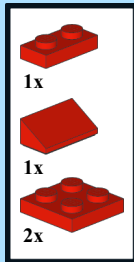

20

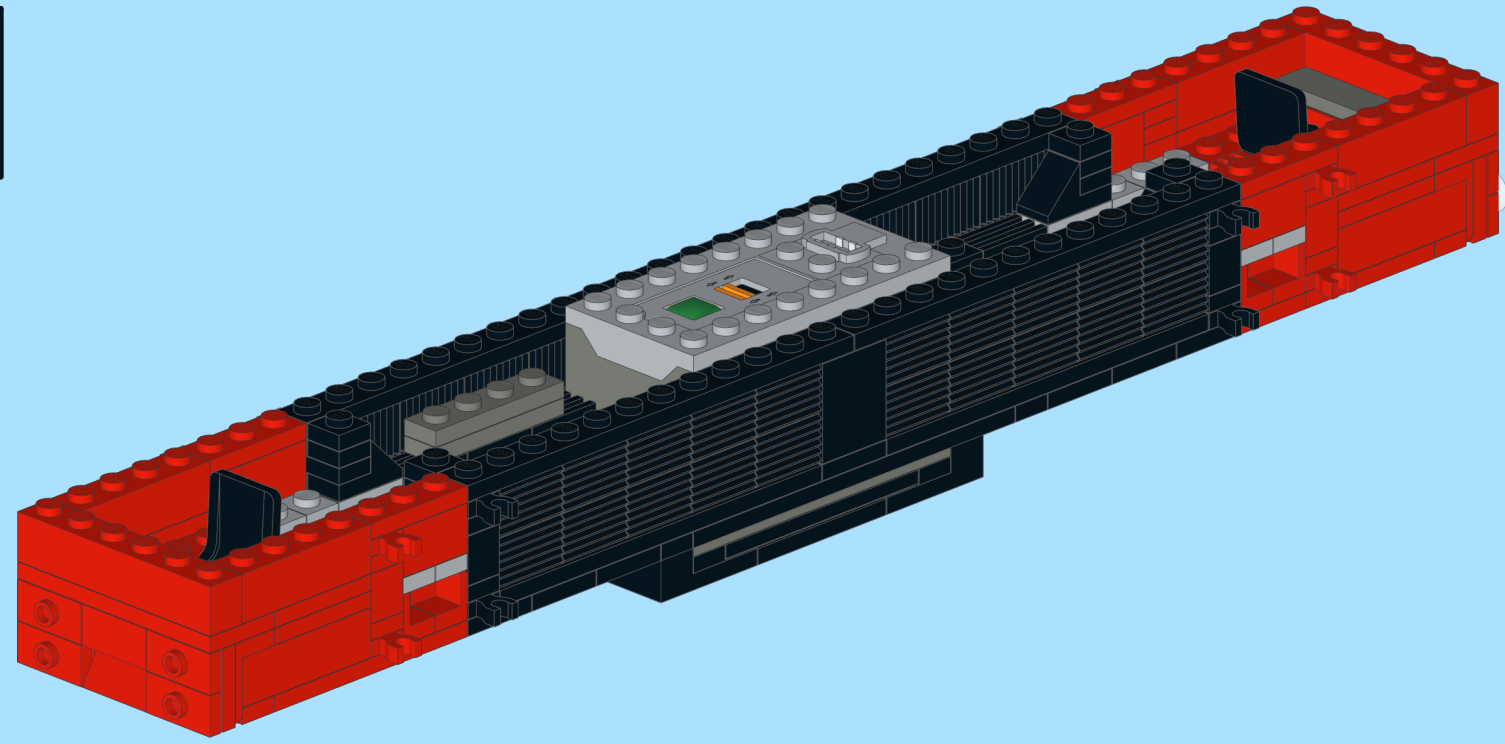
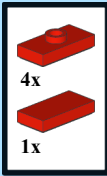

21

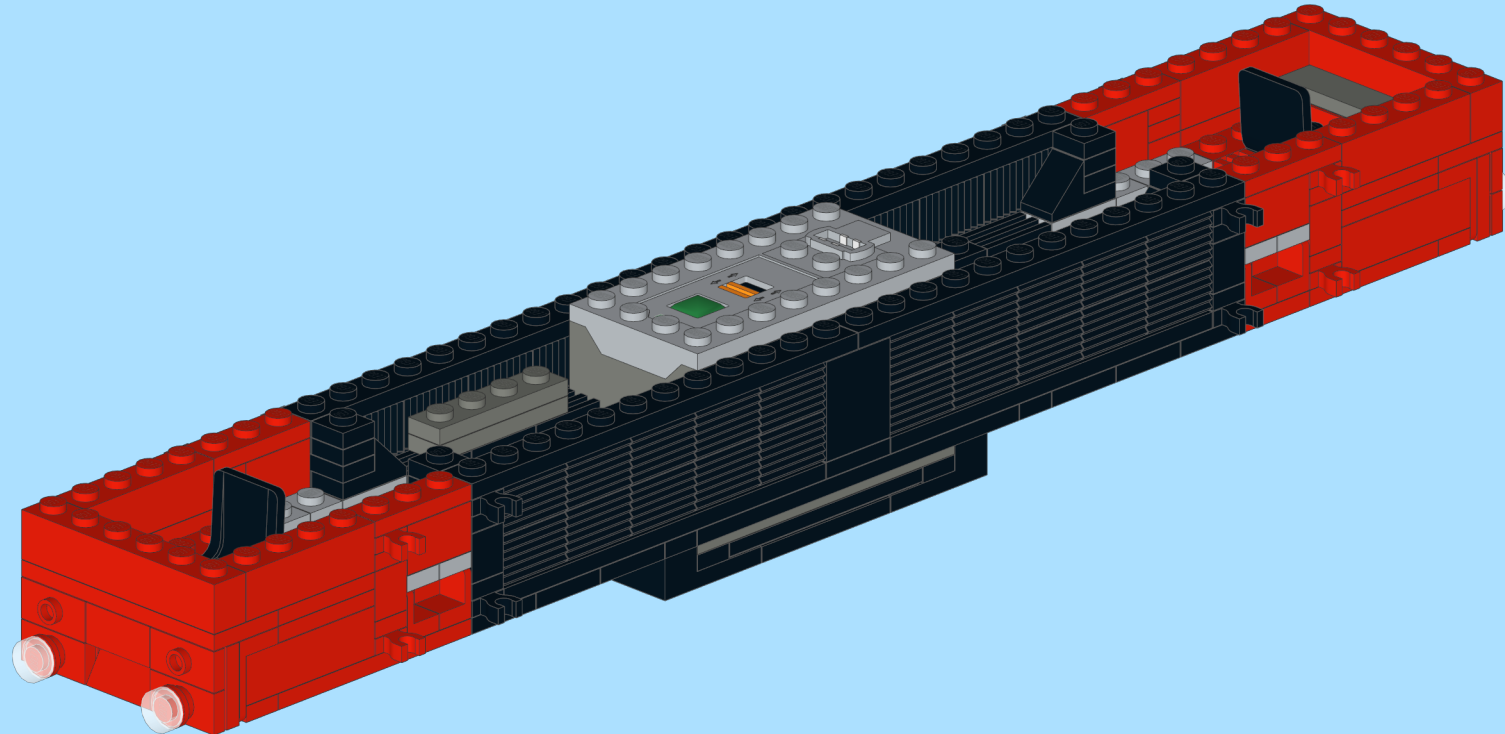

- 22
-  4x
 -  22x
 -  12x
 -  4x

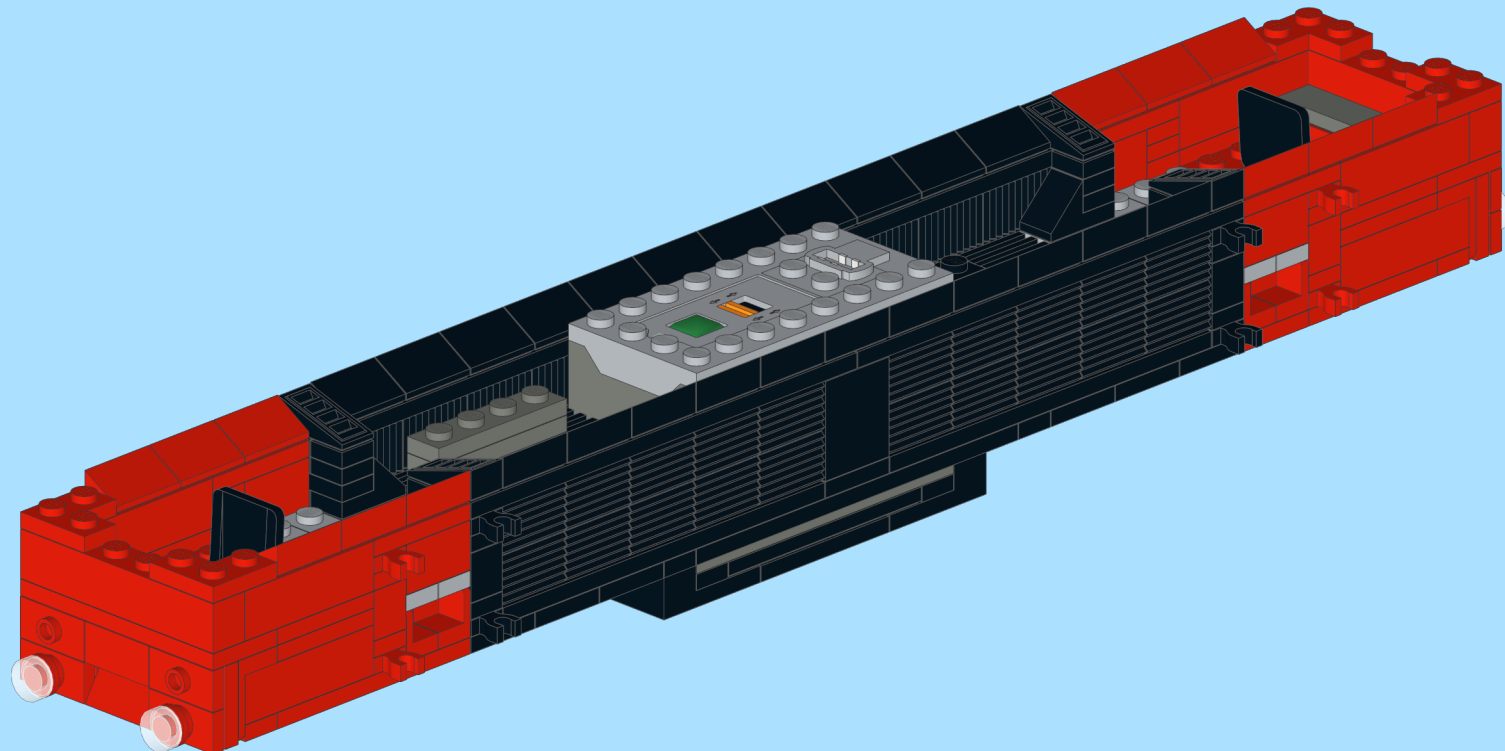

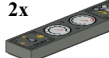
- 23
-  2x
 -  2x

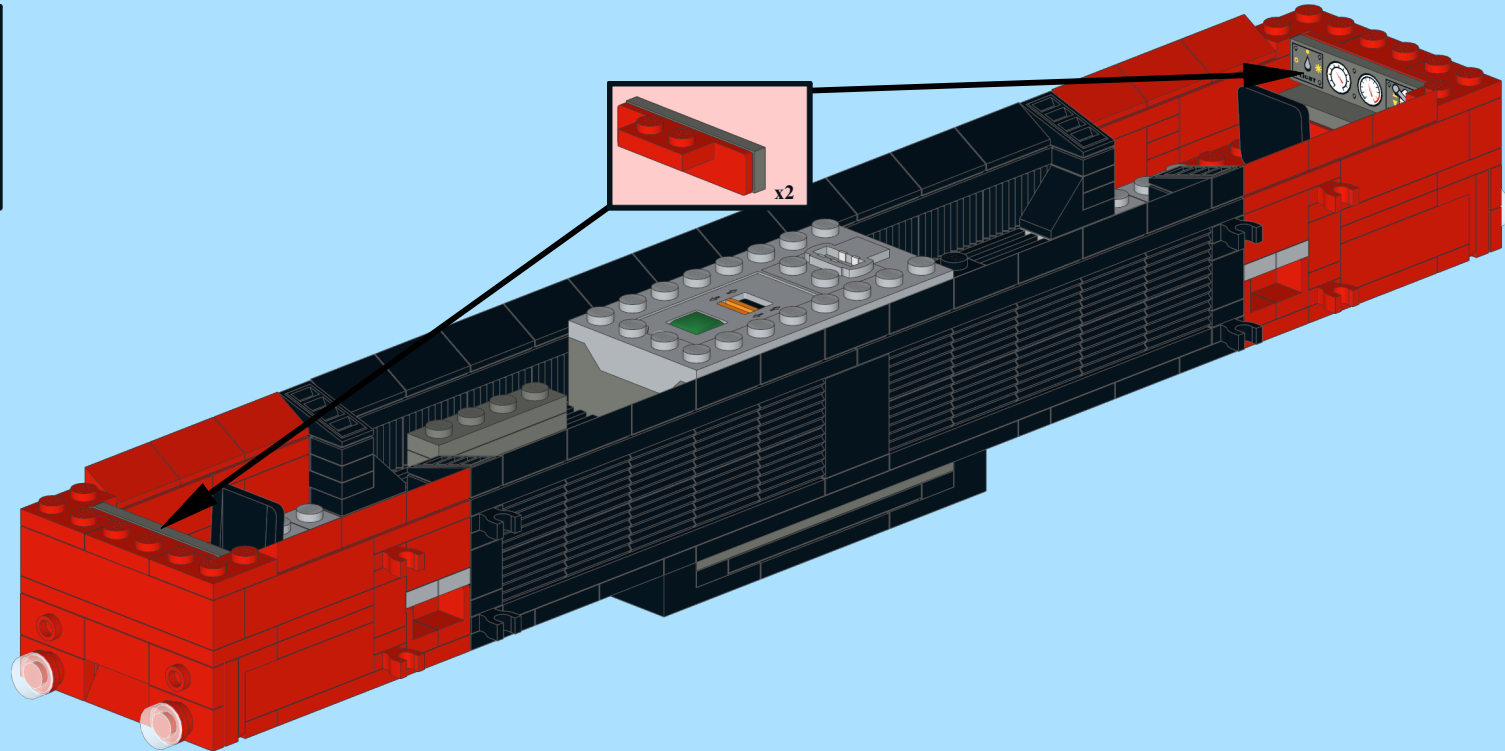

24

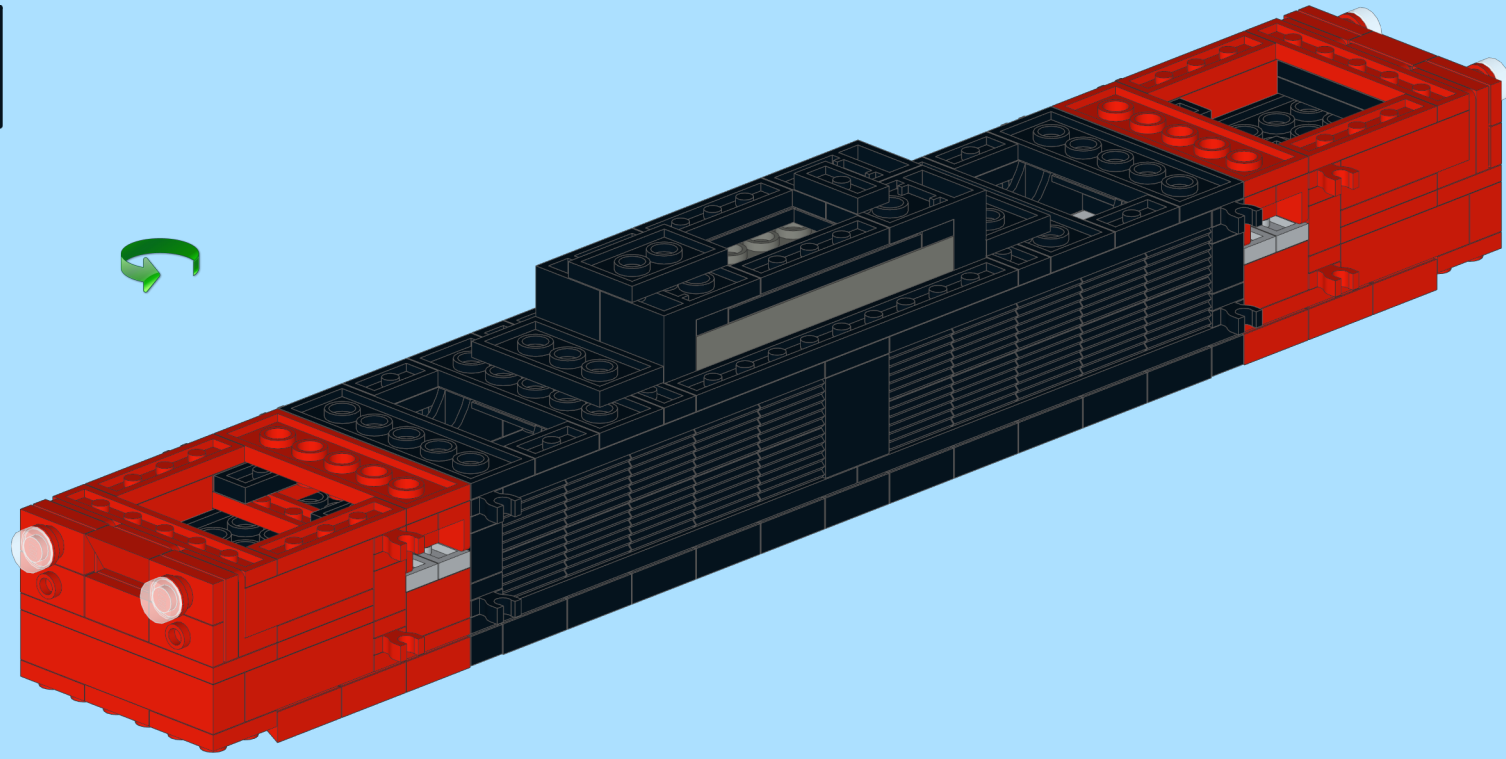
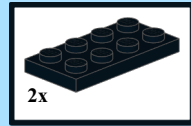

25

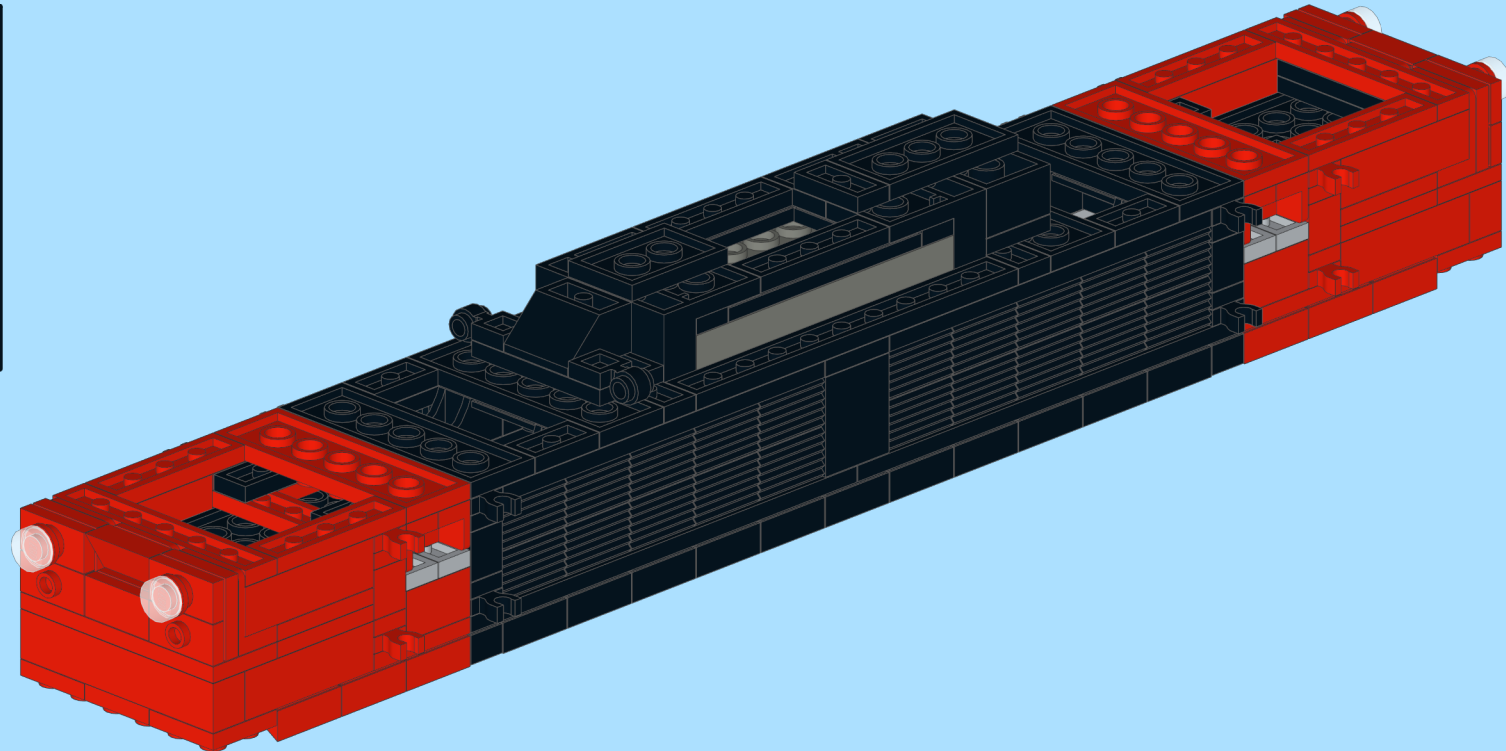
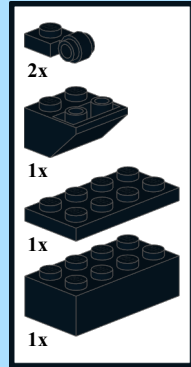

26

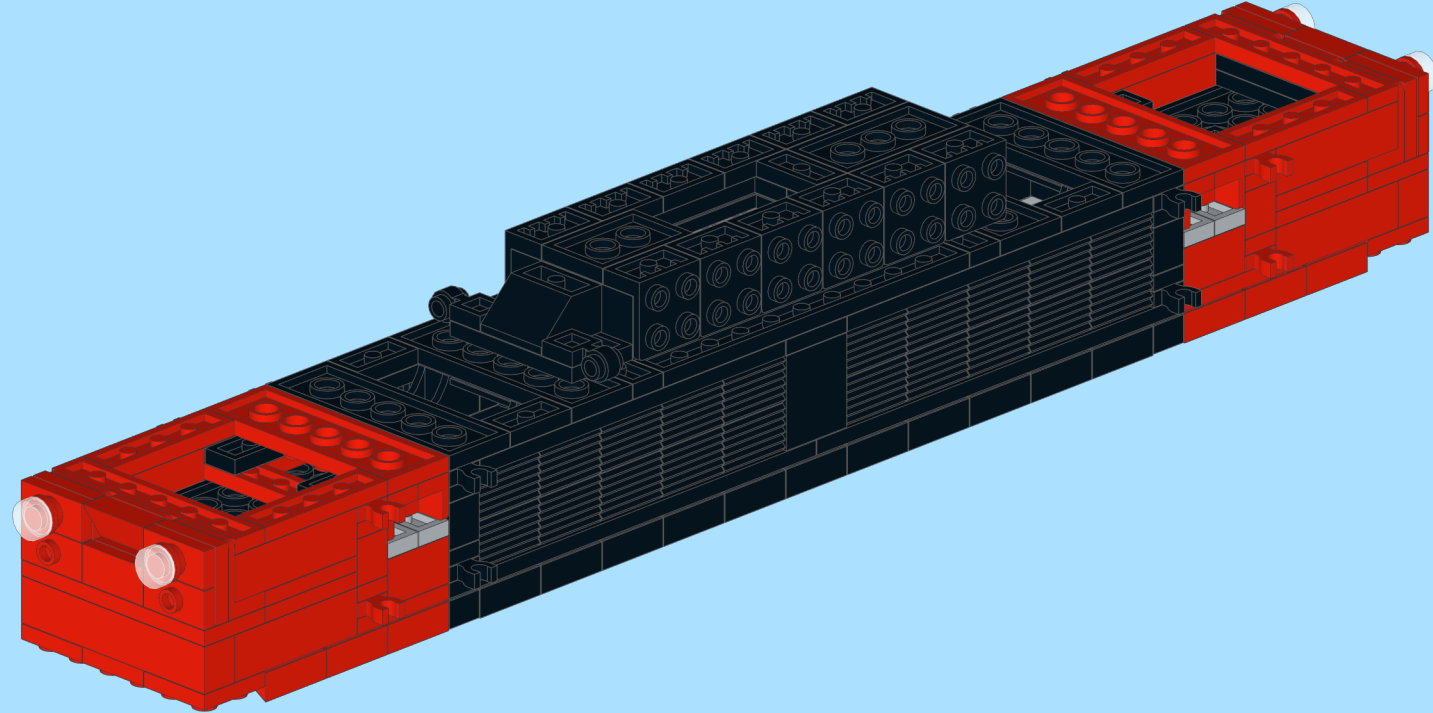

27

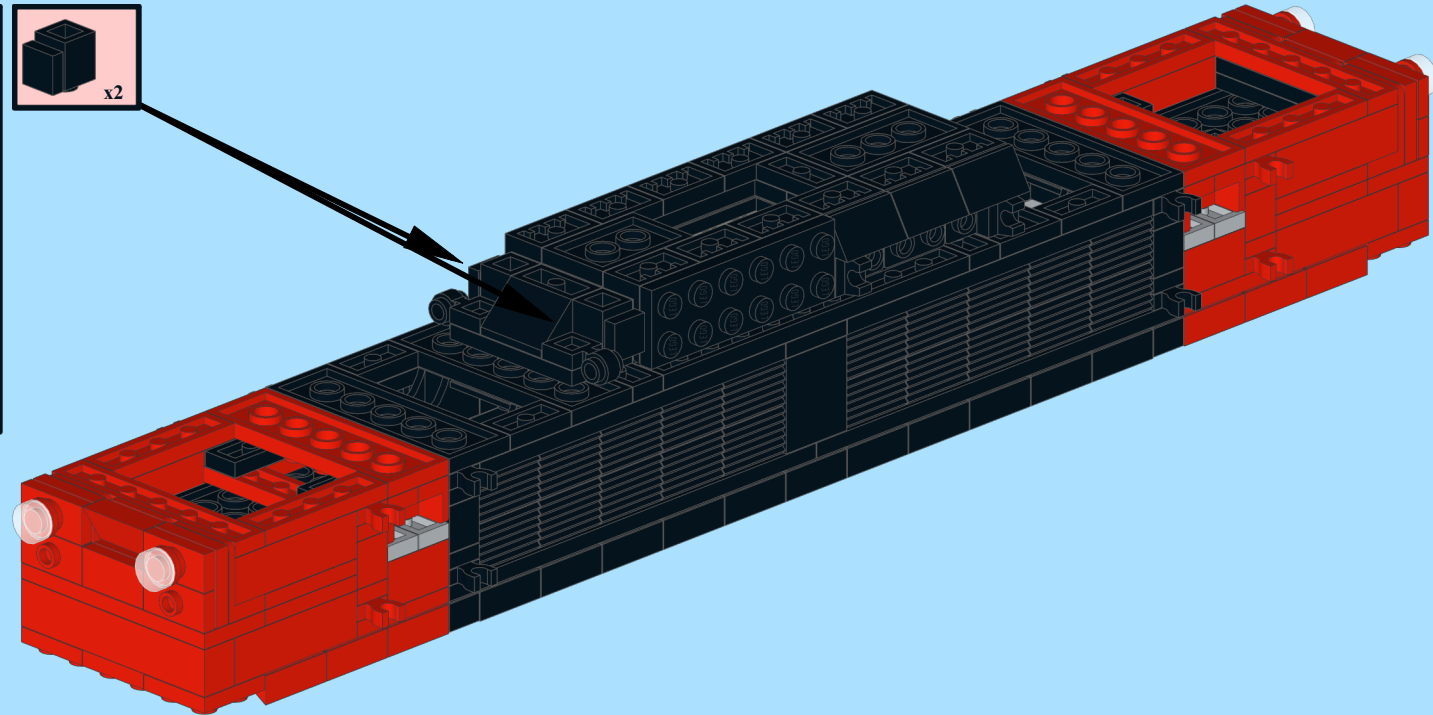
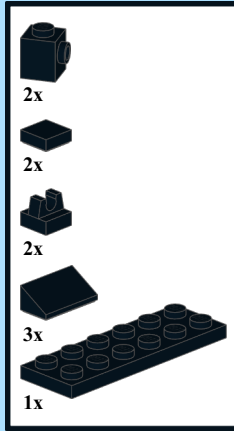



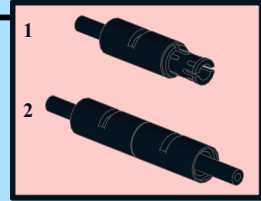
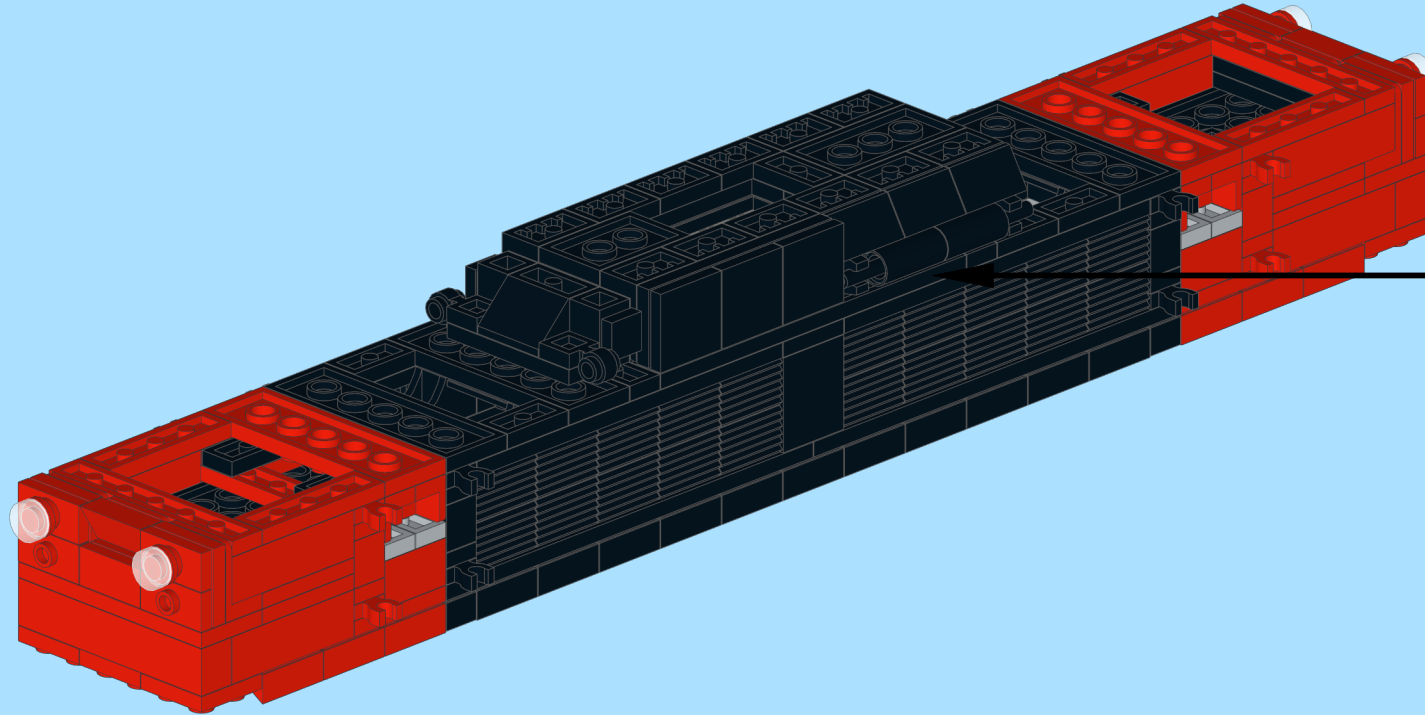
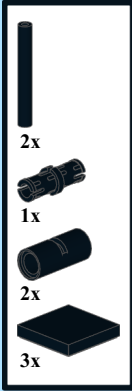

28

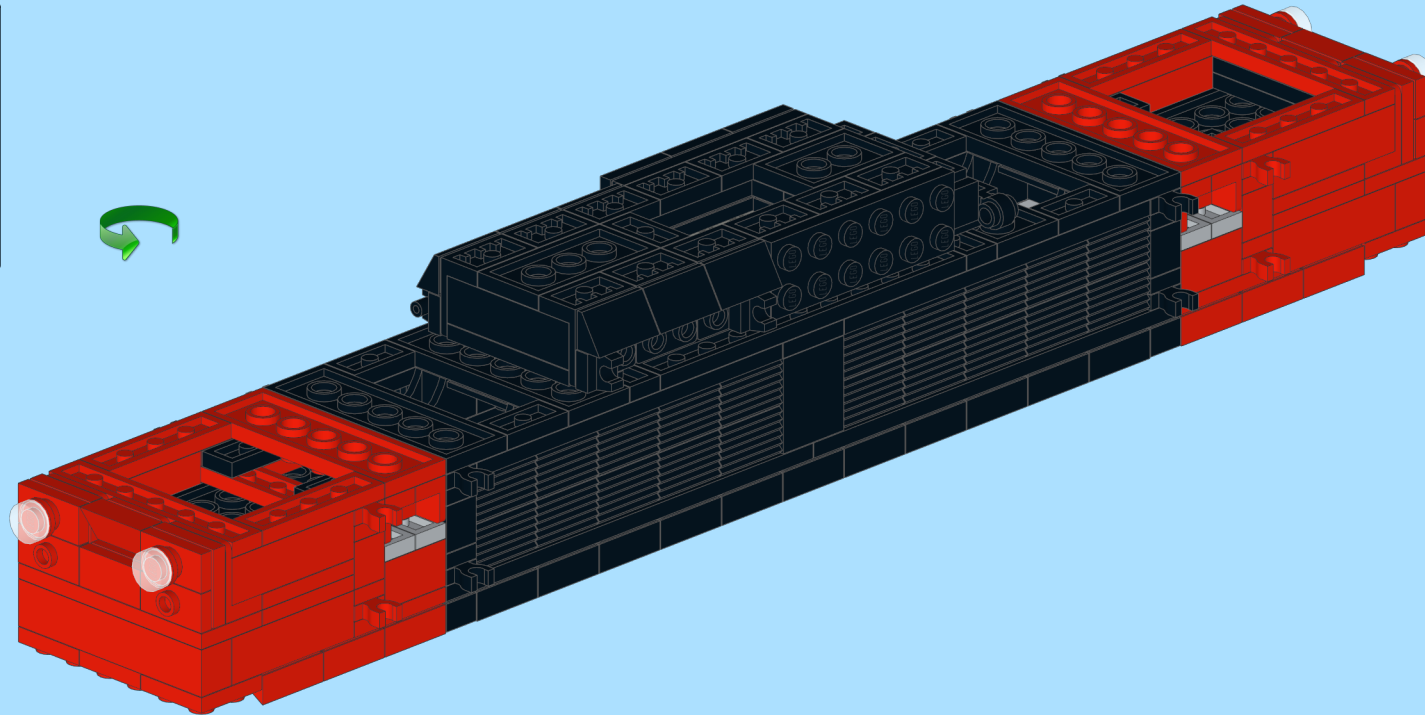
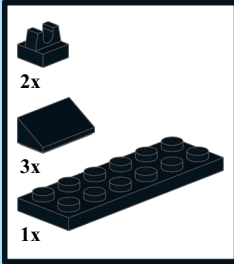

29



- 1x 
- 2x 
- 3x 
- 2x 

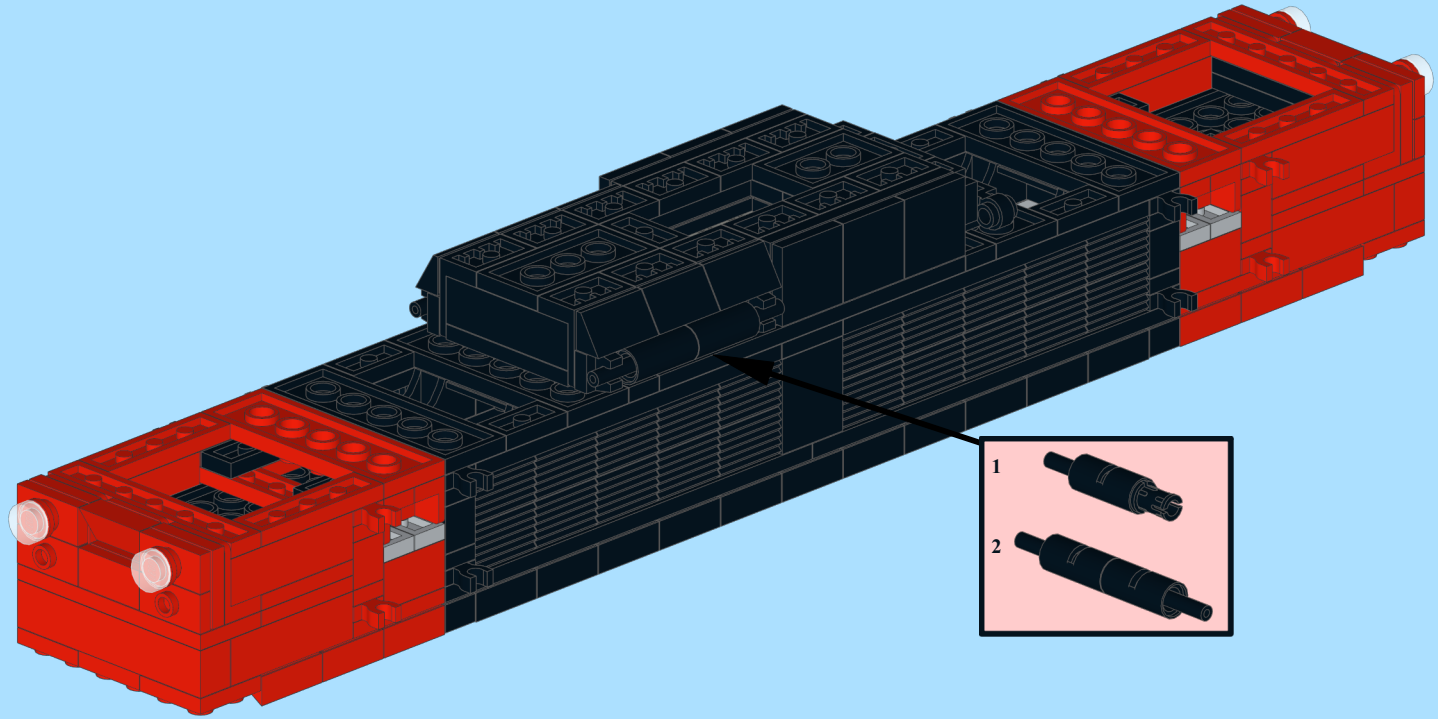

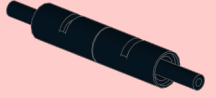
- 1 
- 2 

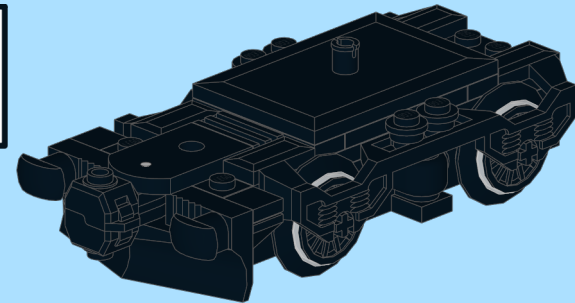
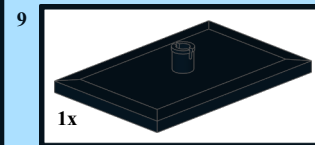
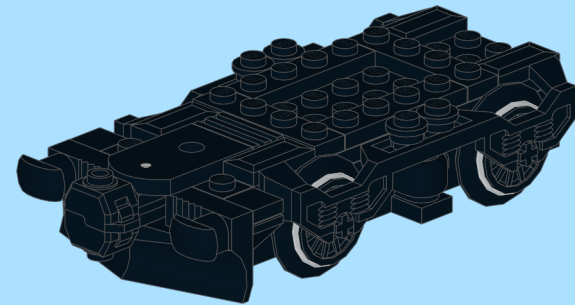
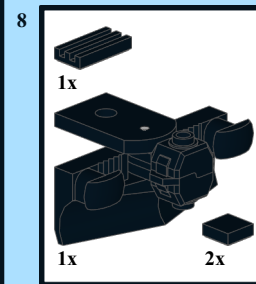
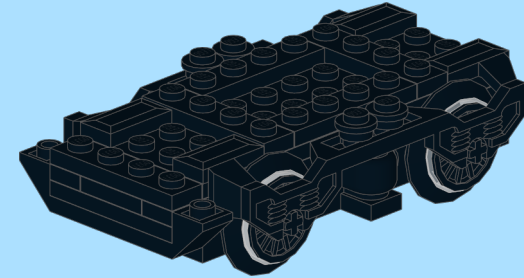
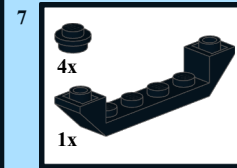
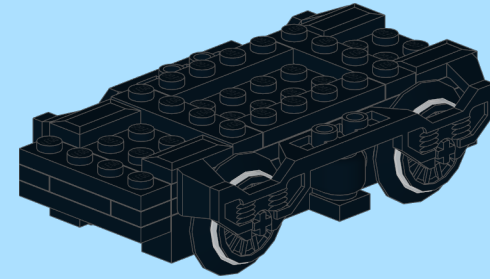
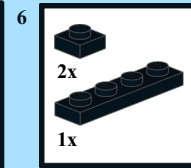
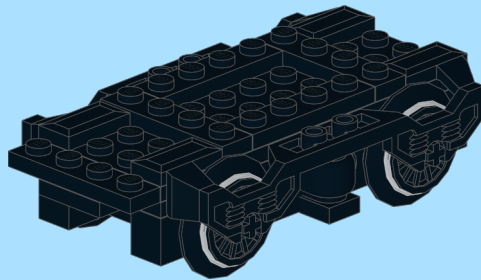
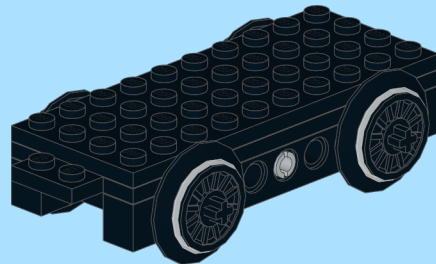
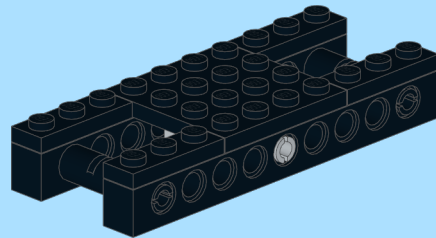
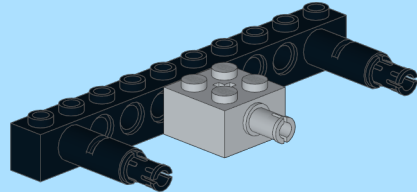
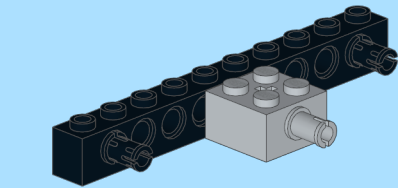
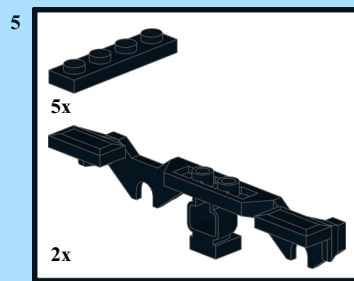
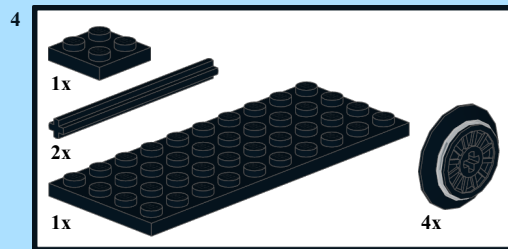
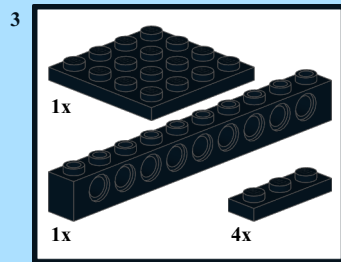
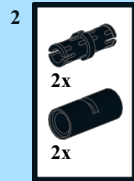
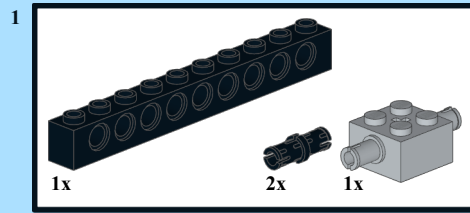

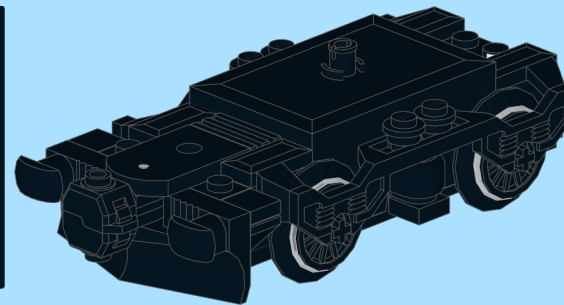
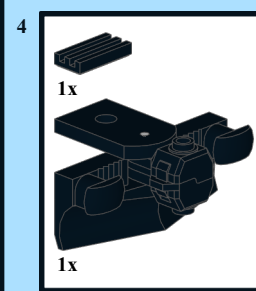
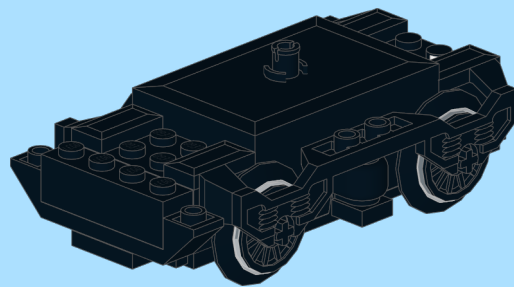
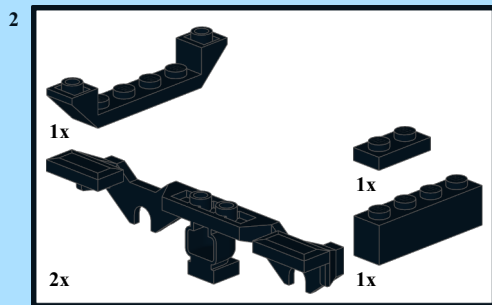
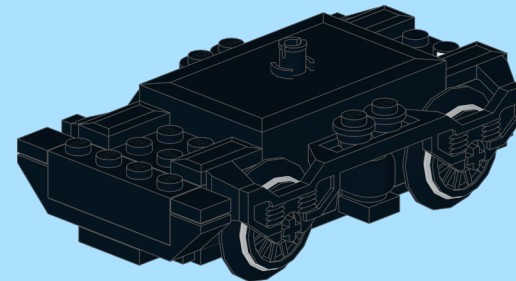
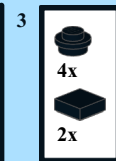
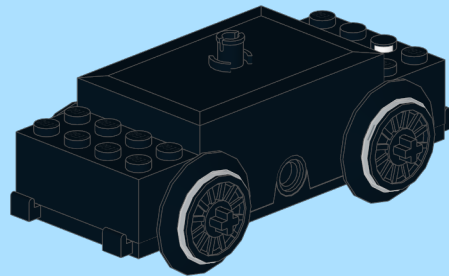
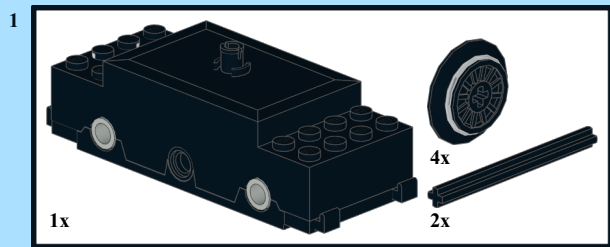

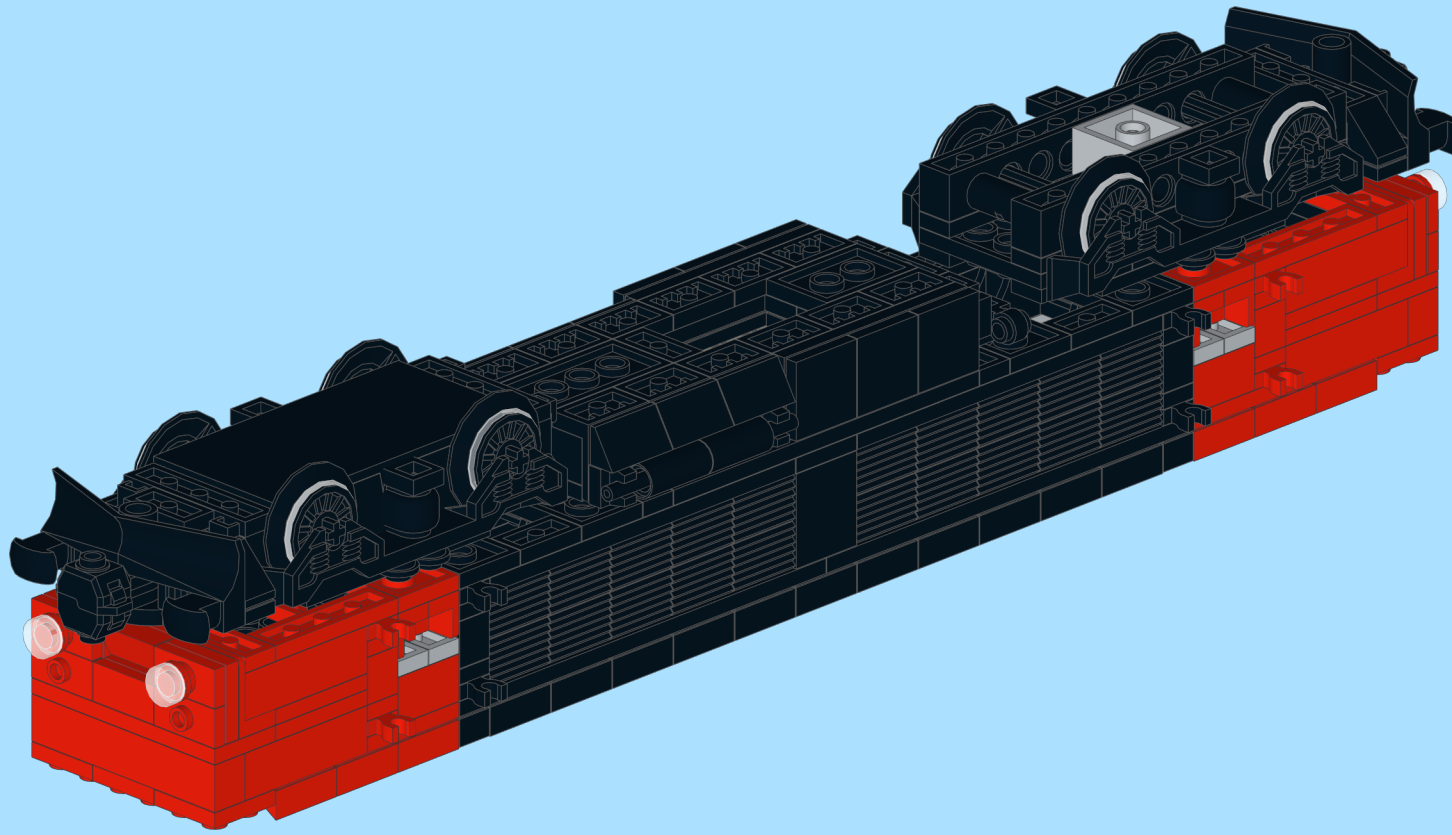

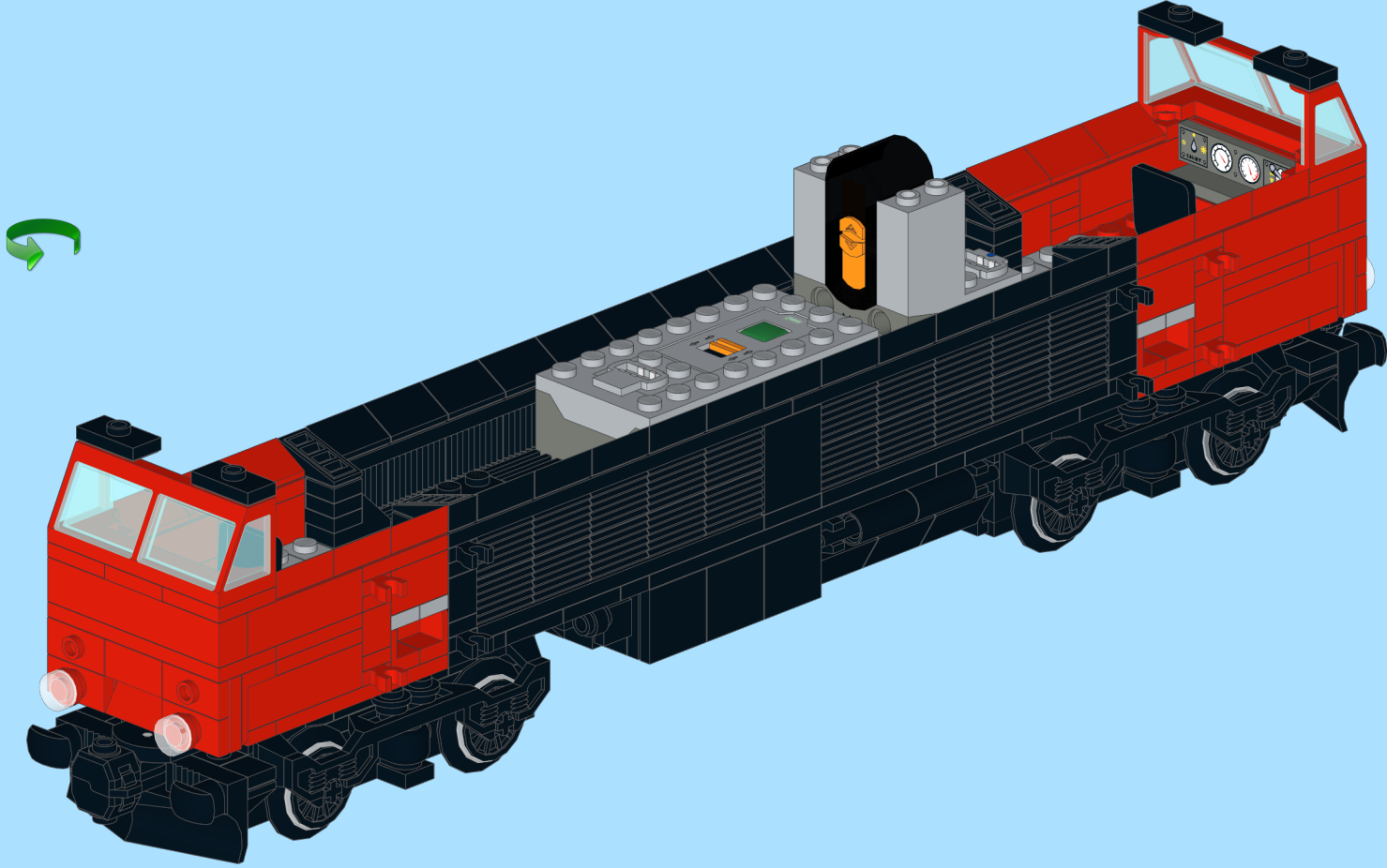
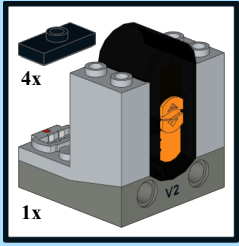

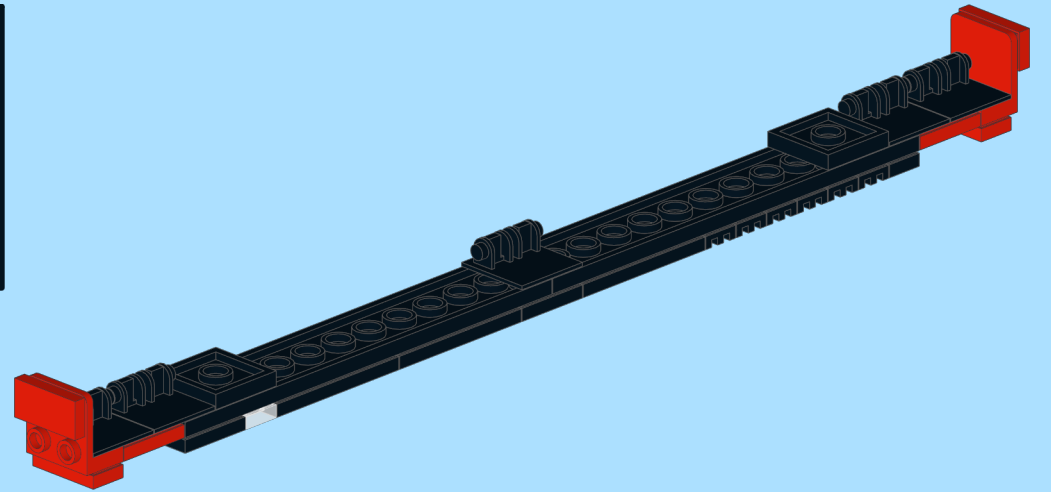
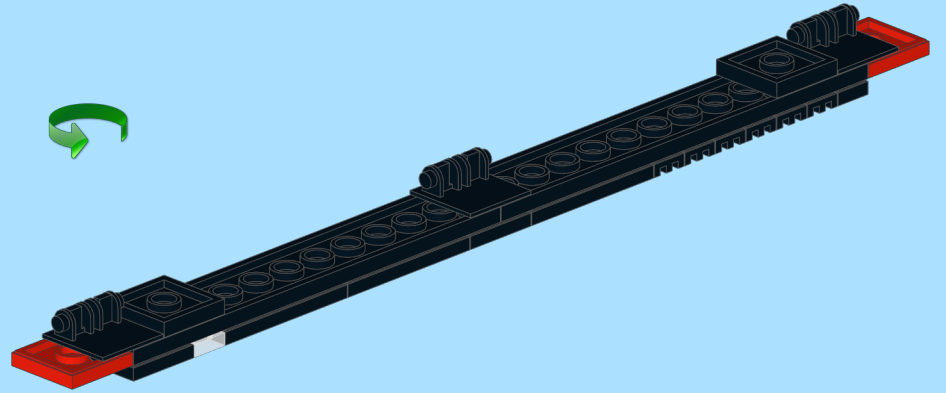
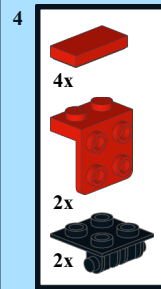
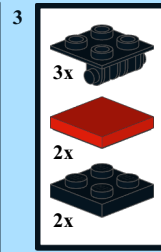
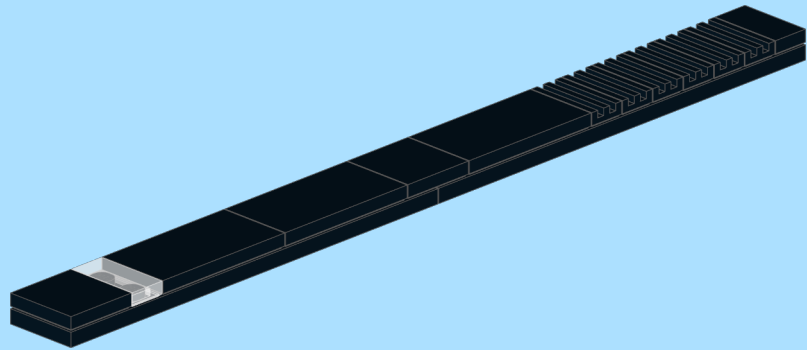
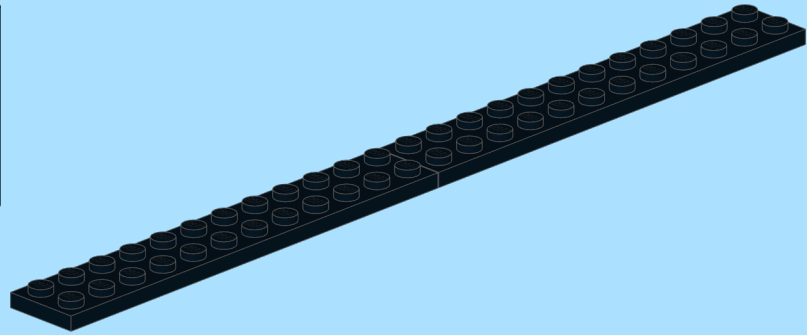
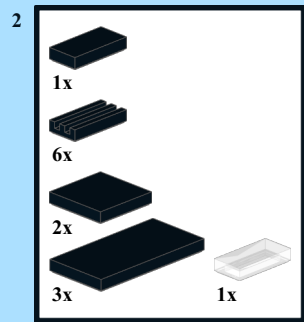
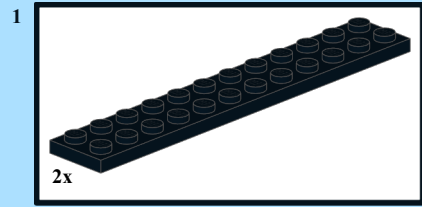



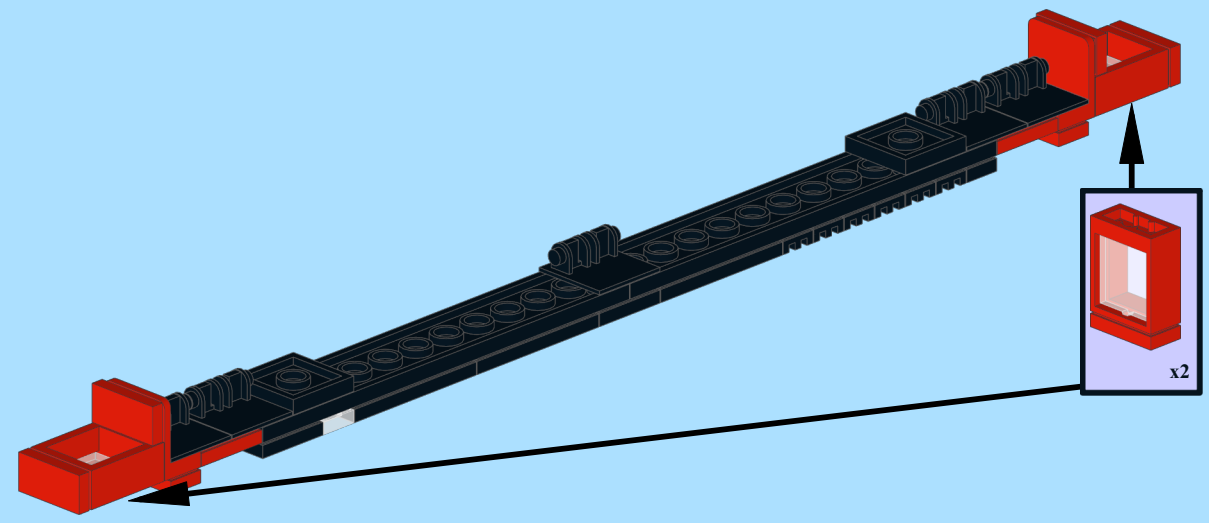
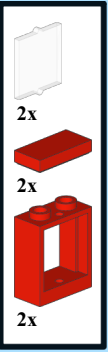

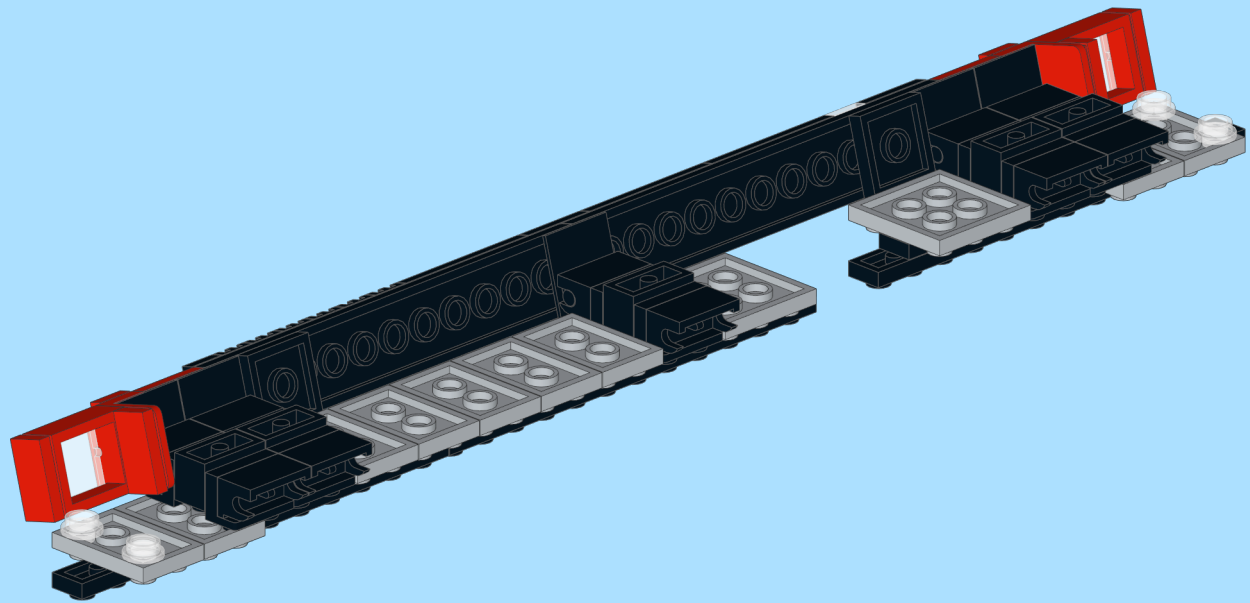
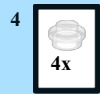
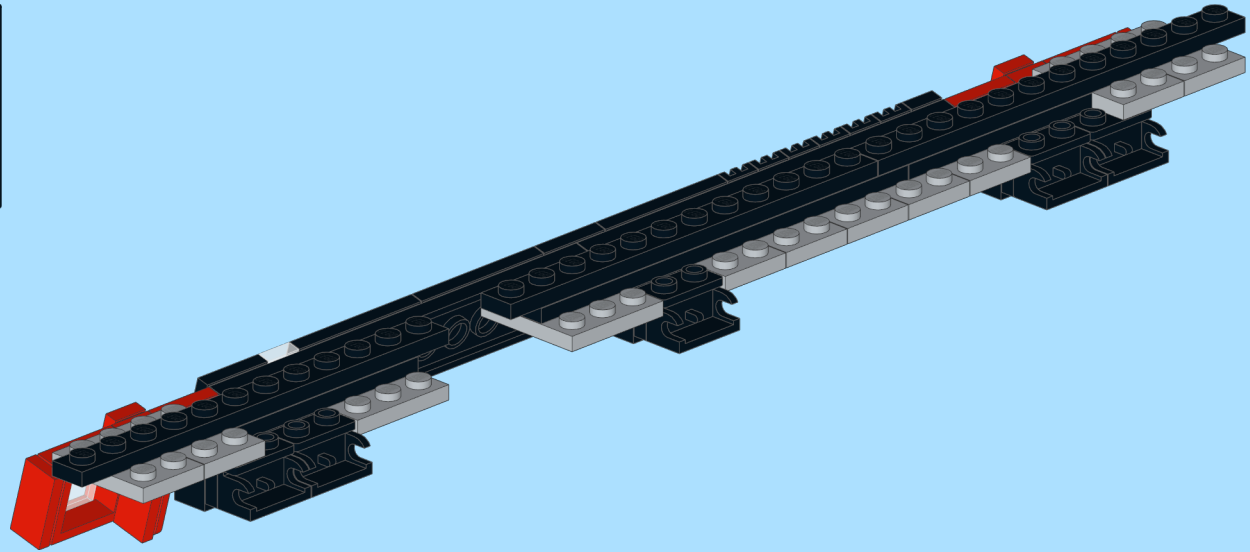
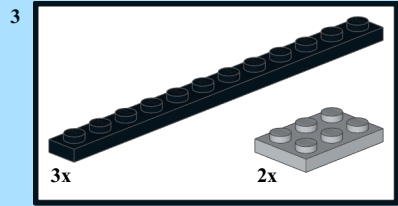



5





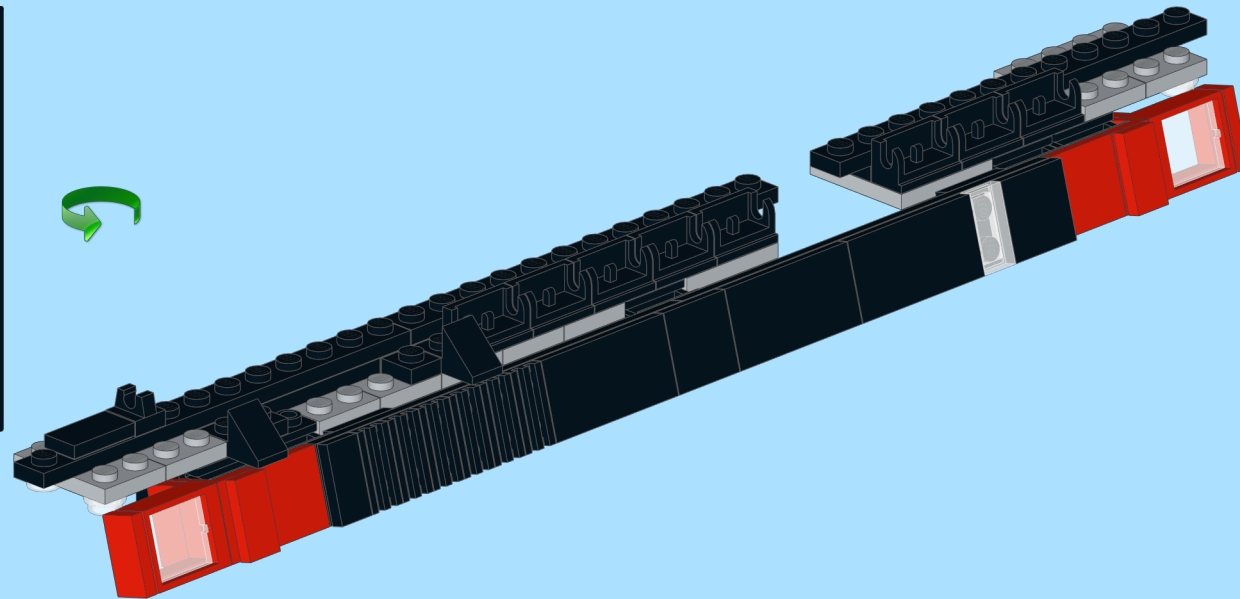



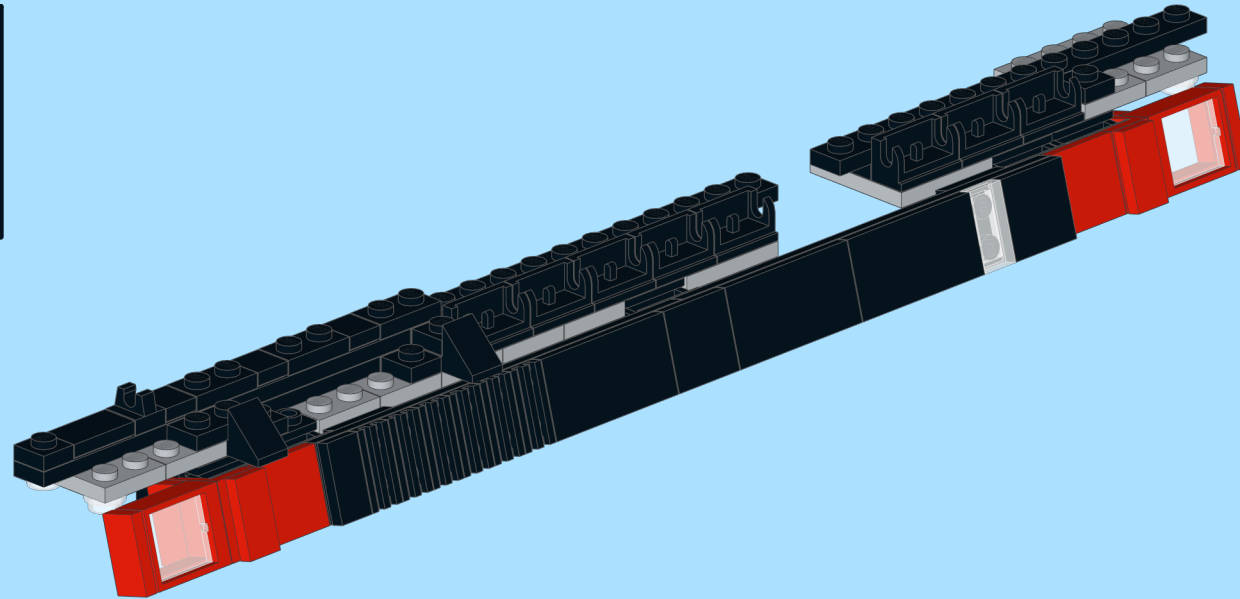

- 5
-  2x
 -  1x
 -  1x
 -  2x
 -  8x







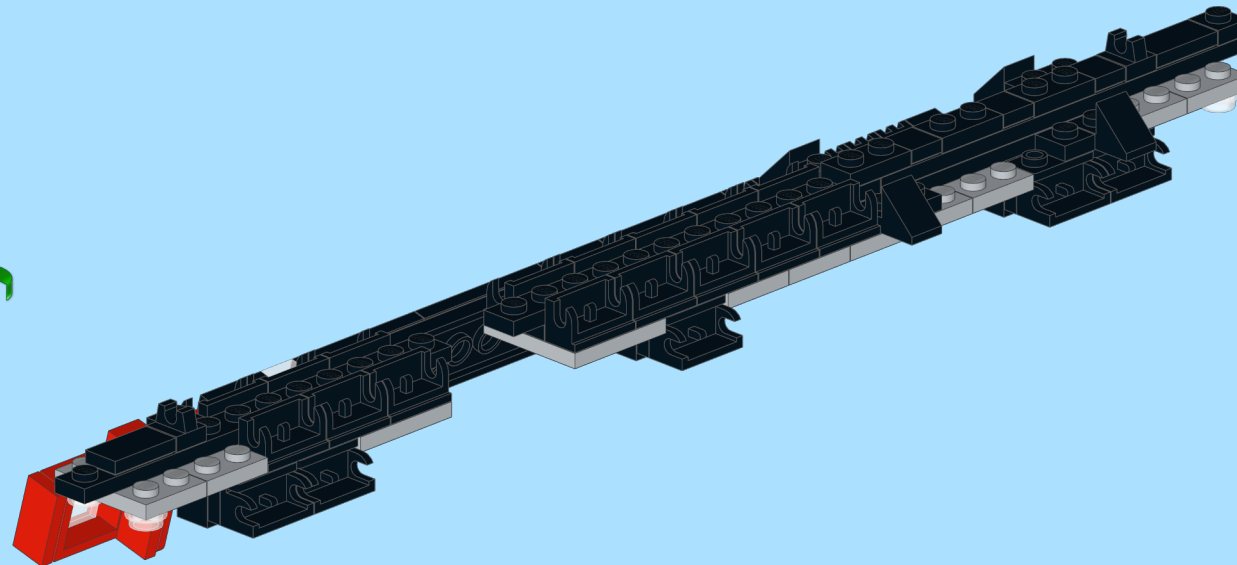

- 6
-  3x
 -  3x
 -  4x



- 7
-  2x
 -  1x
 -  1x
 -  2x
 -  8x



- 8
-  1x
 -  3x
 -  4x
 -  1x
 -  1x
 -  1x

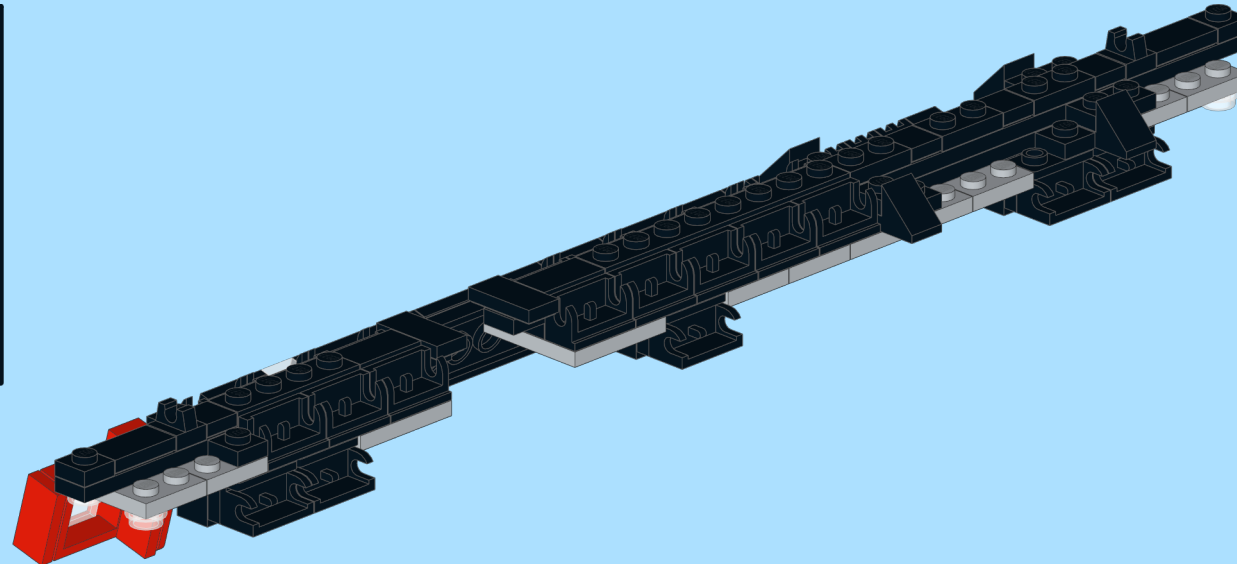

9

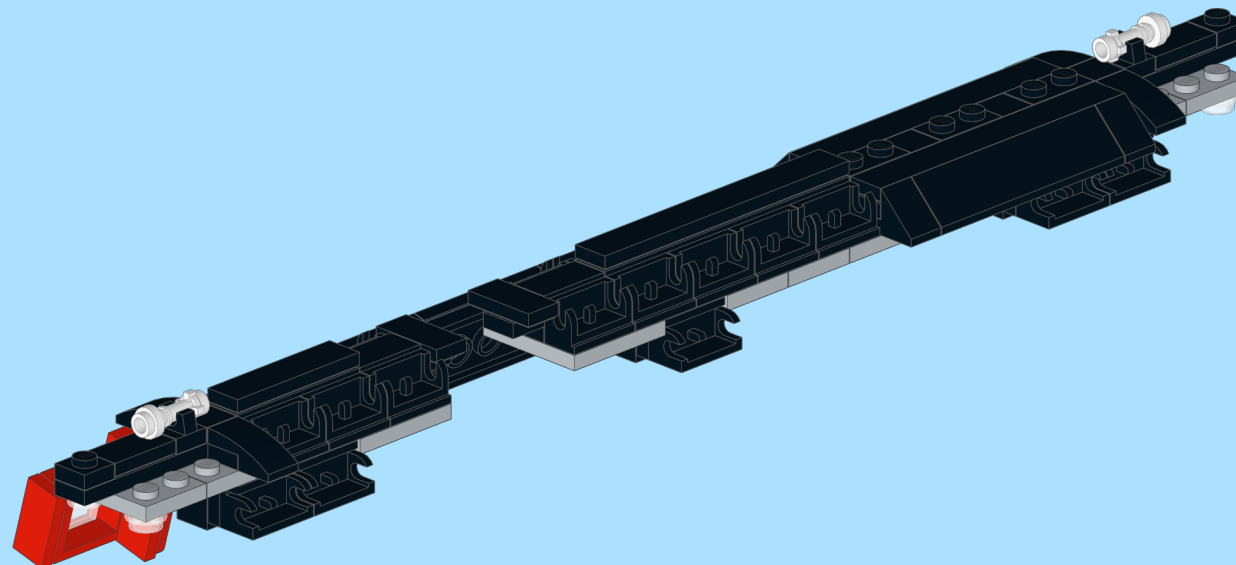
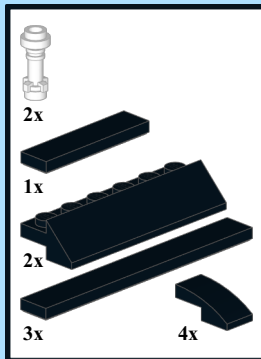

10

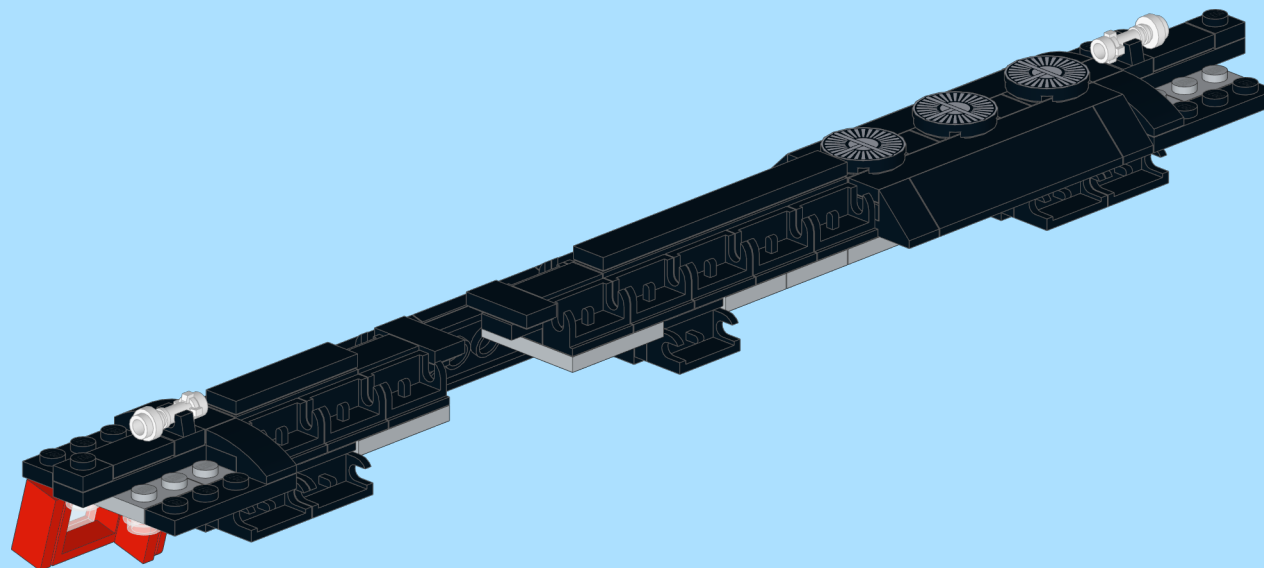
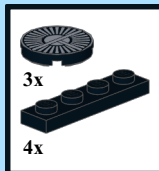

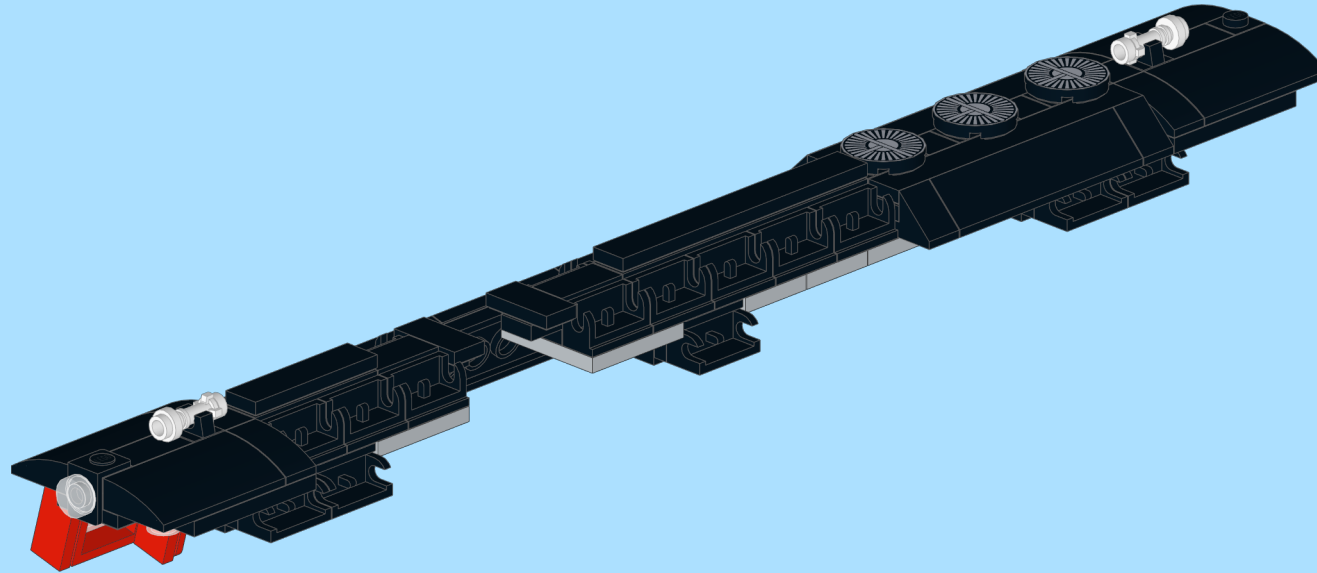
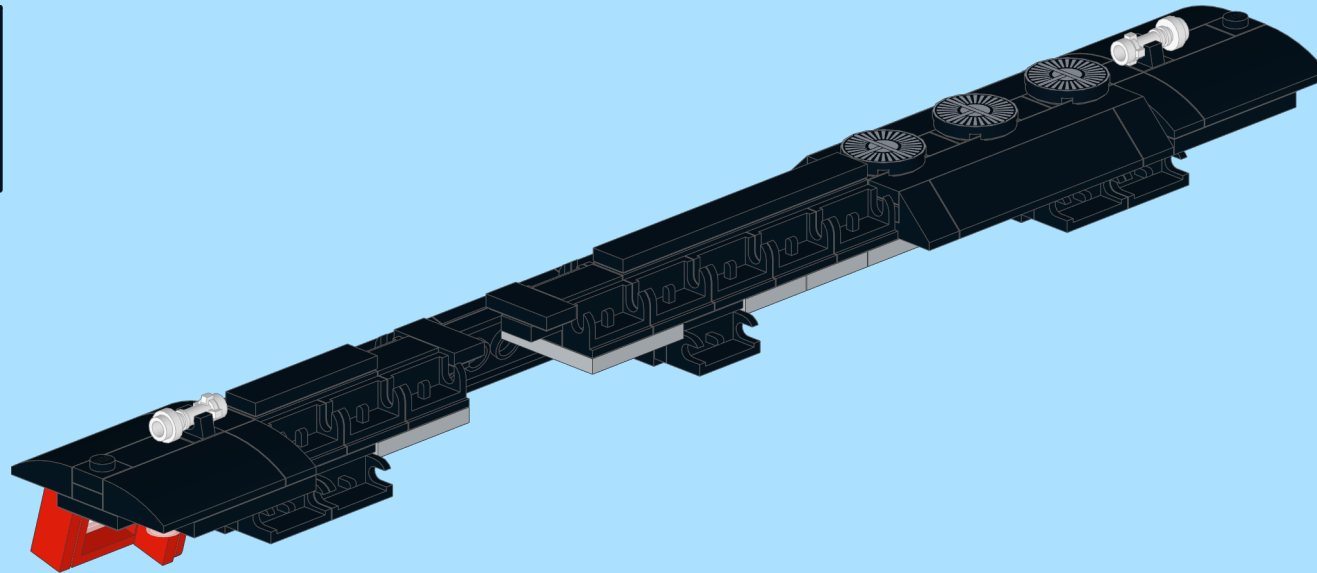
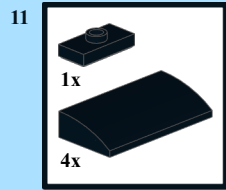

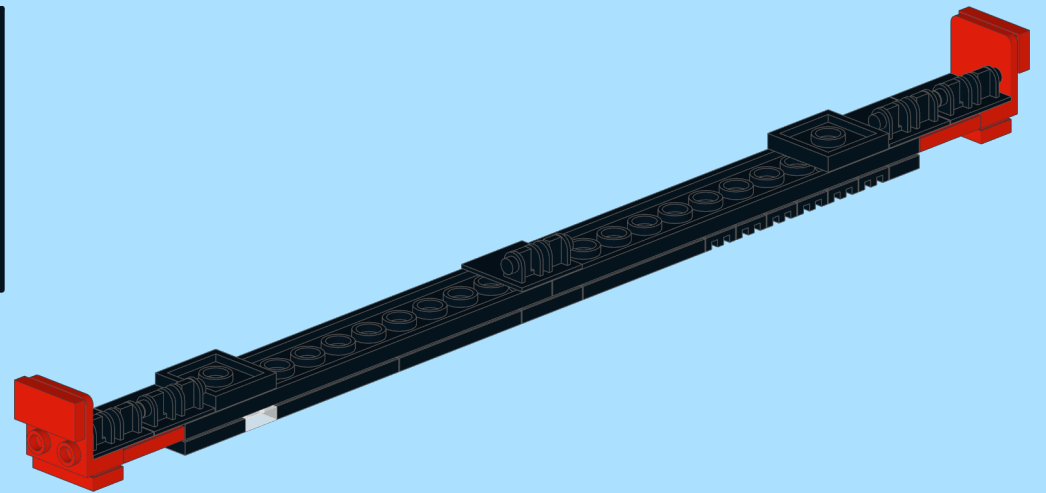
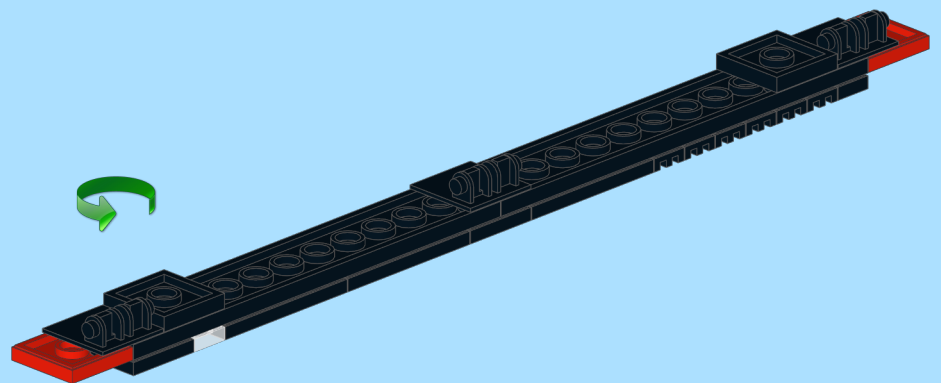
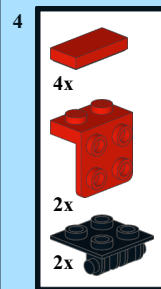
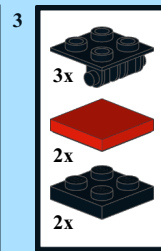
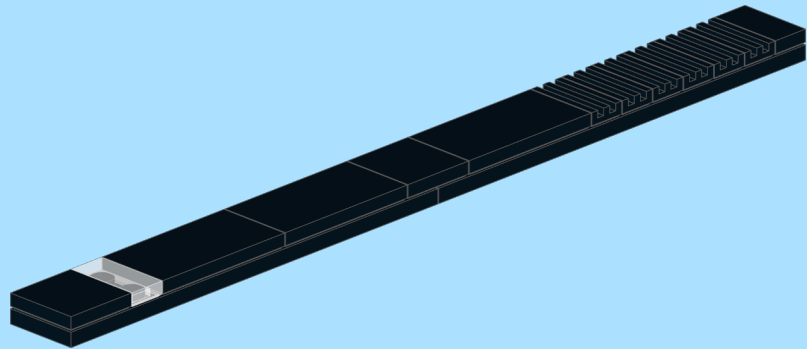
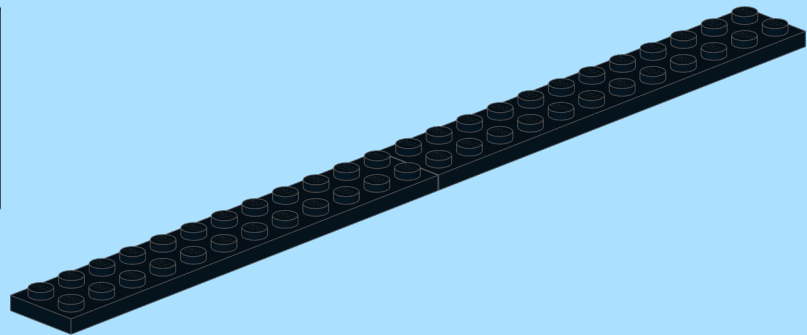
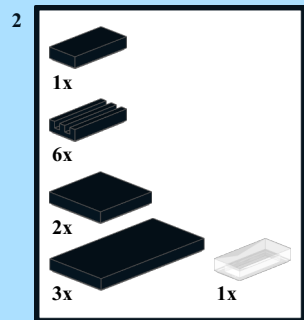
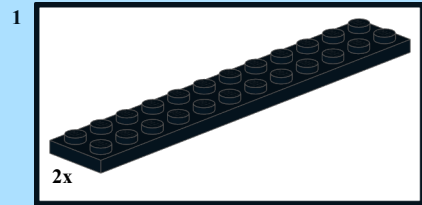

5

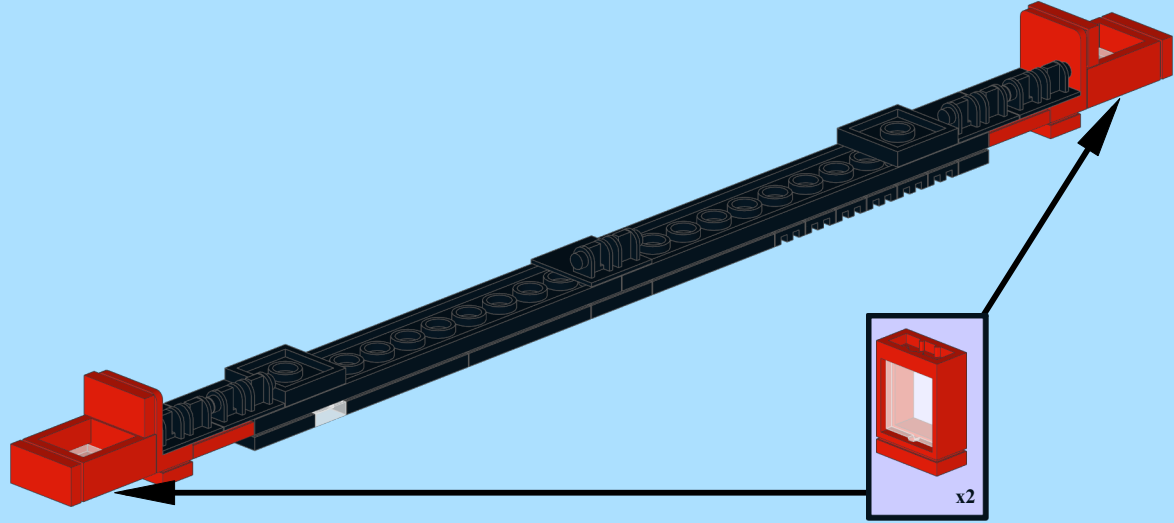
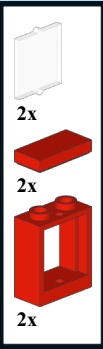

13

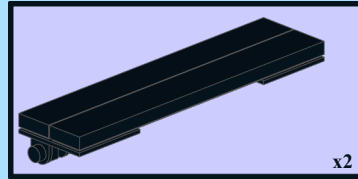
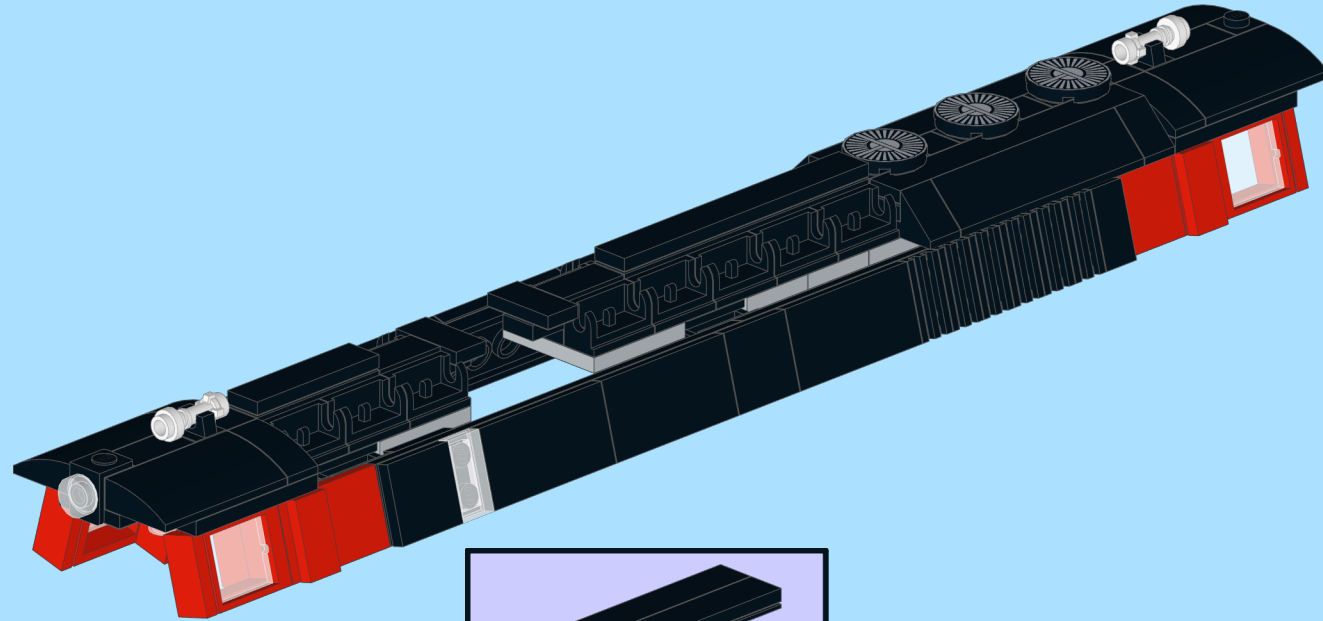



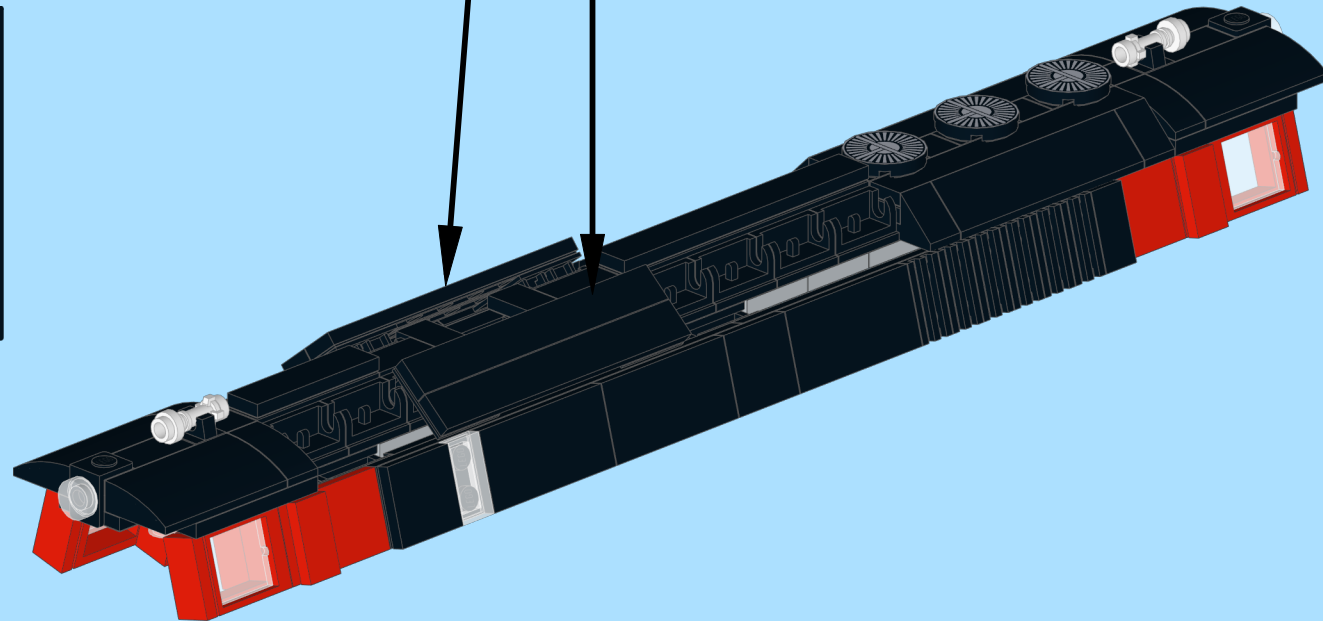
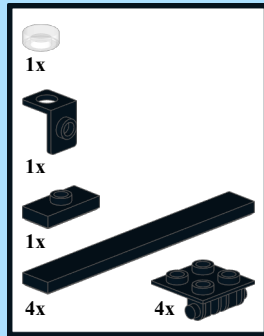

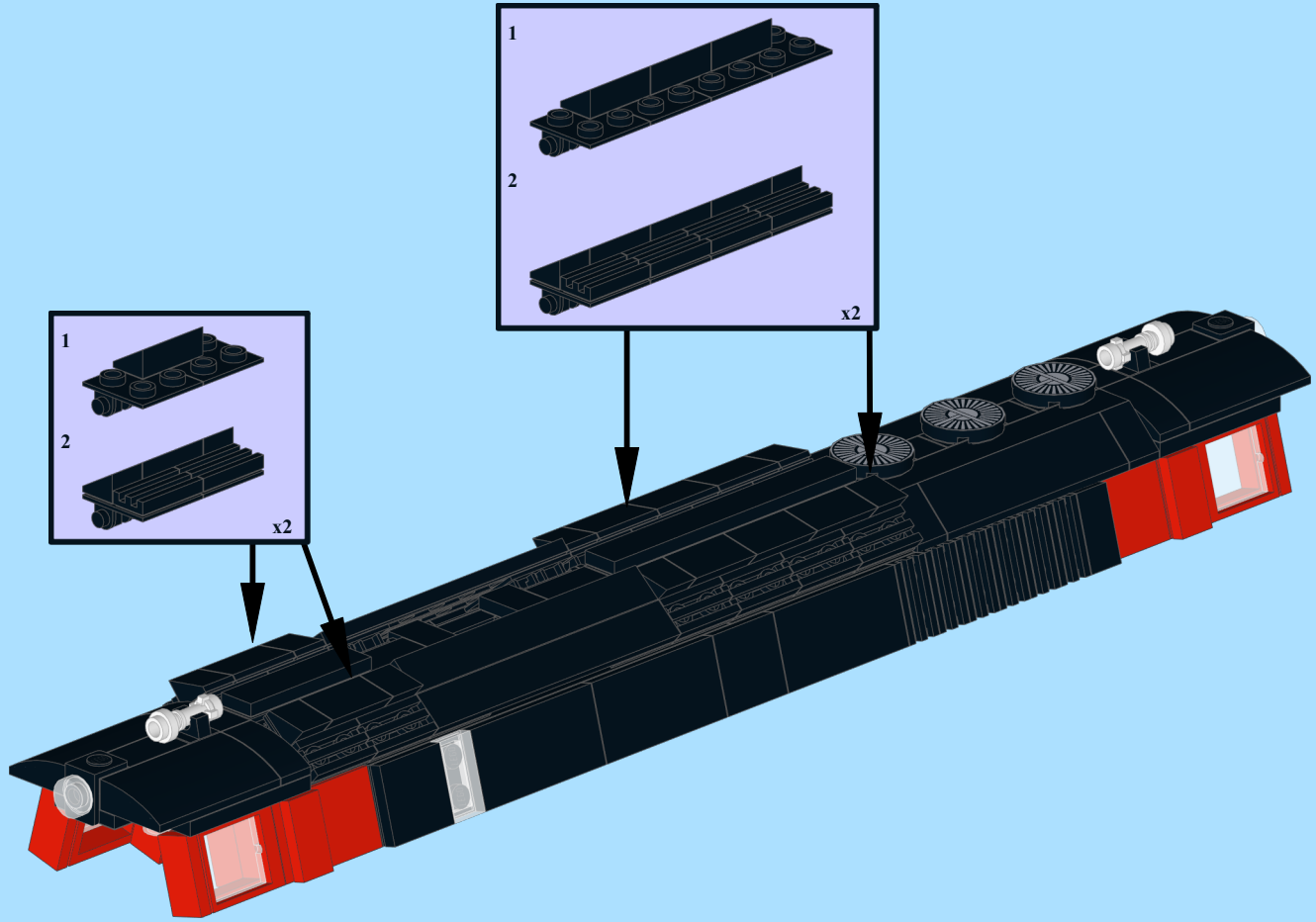
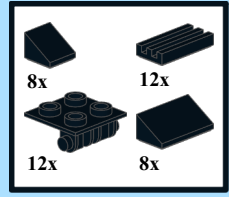

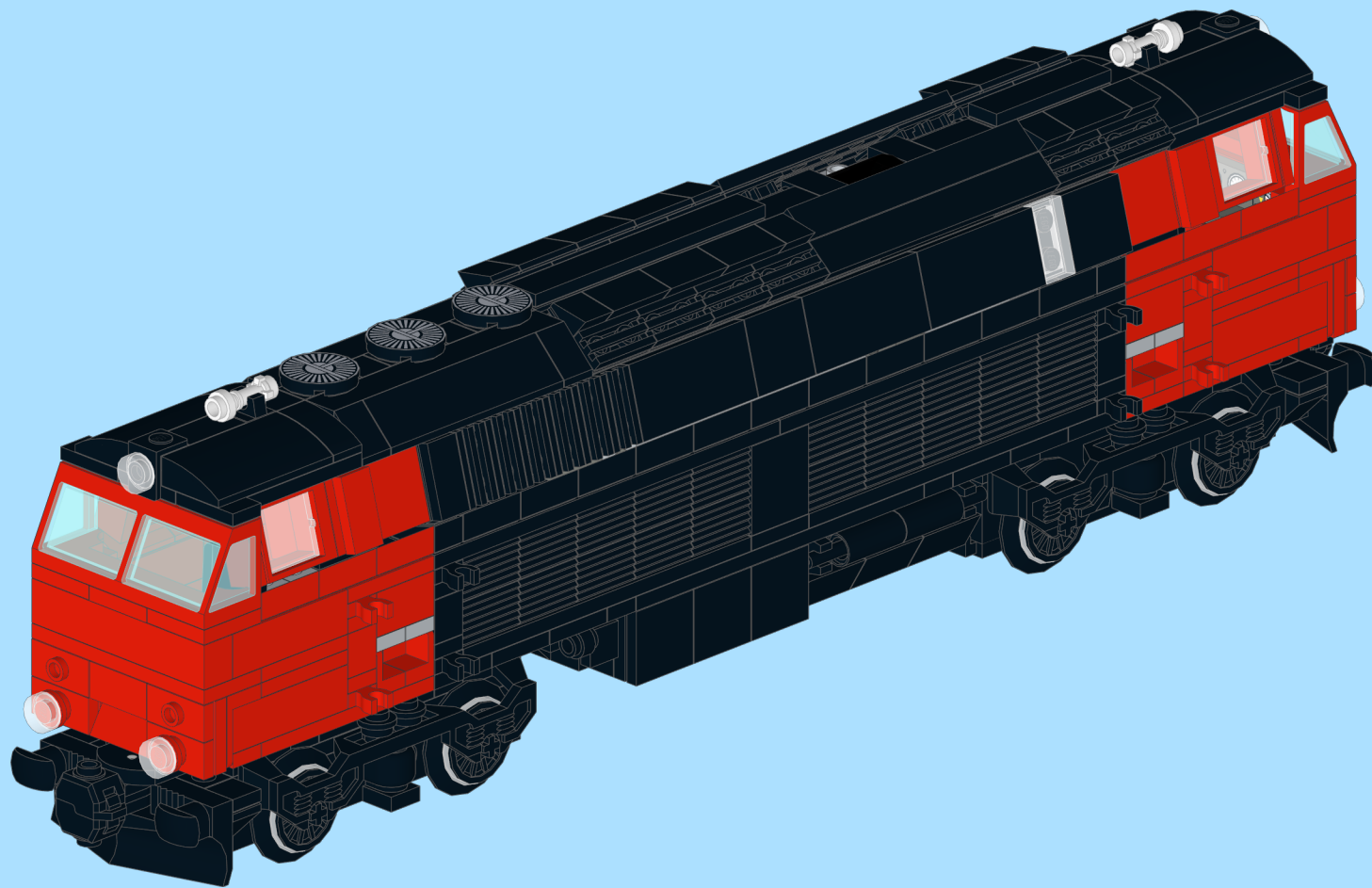
14

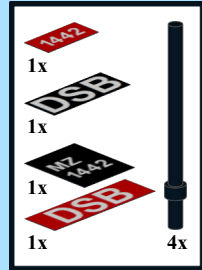







-  1x
-  1x
-  1x
-  1x
-  4x





