

Hogwards Express

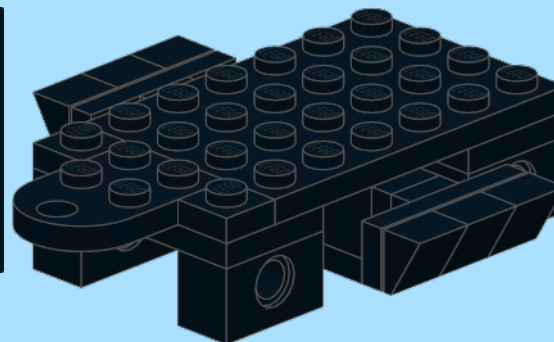

Original Design By
Tim Gould and James Mathis

INSTRUCTION BY
KNUD ALBRECHTSEN
www.snakebyte.dk/lego

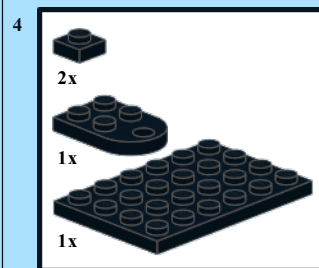
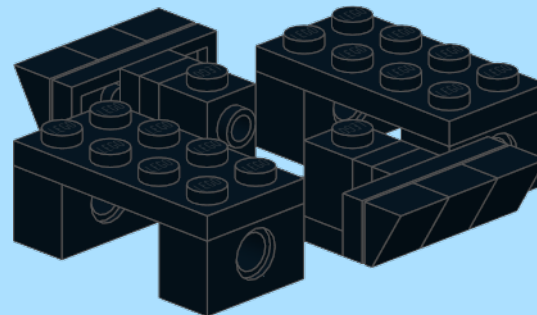
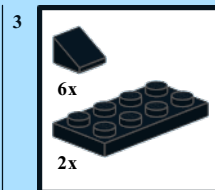
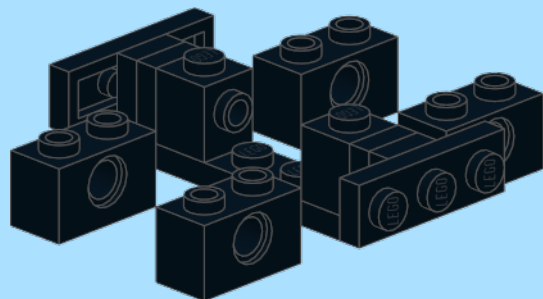
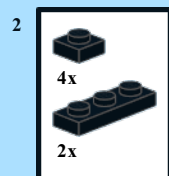
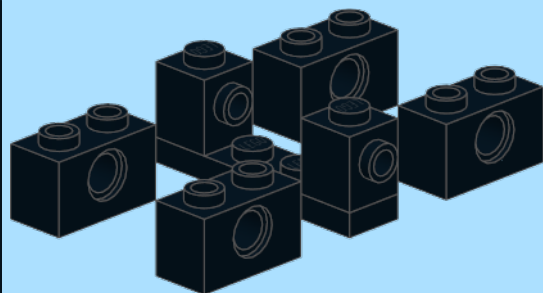
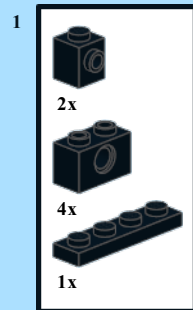

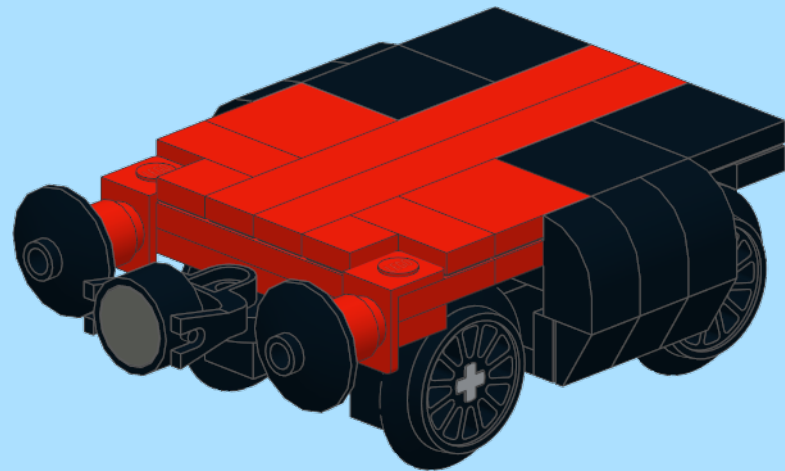
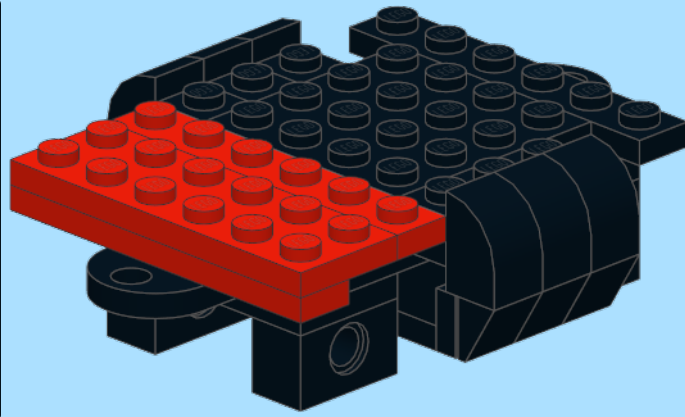
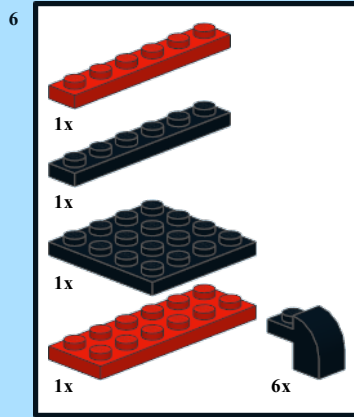
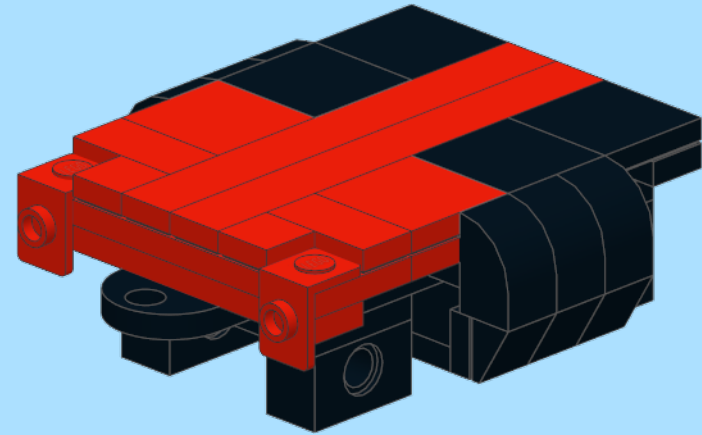
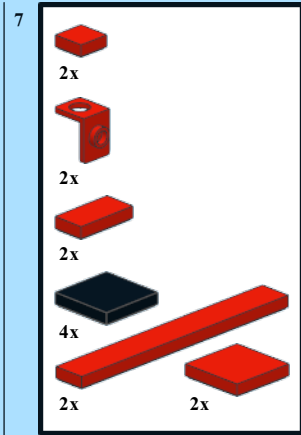
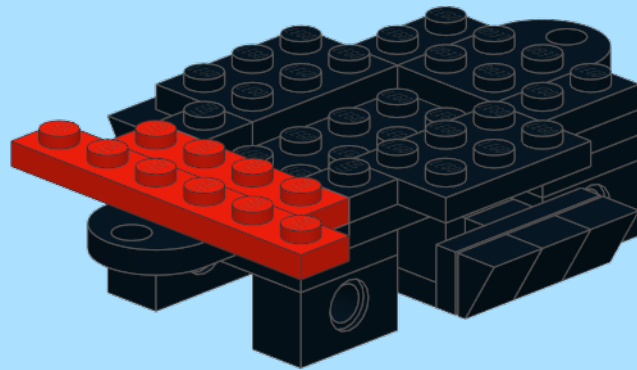
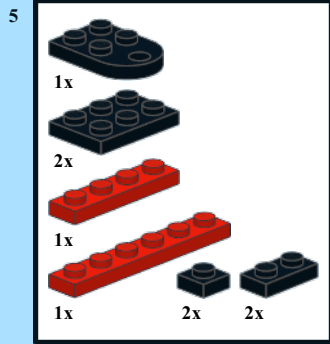

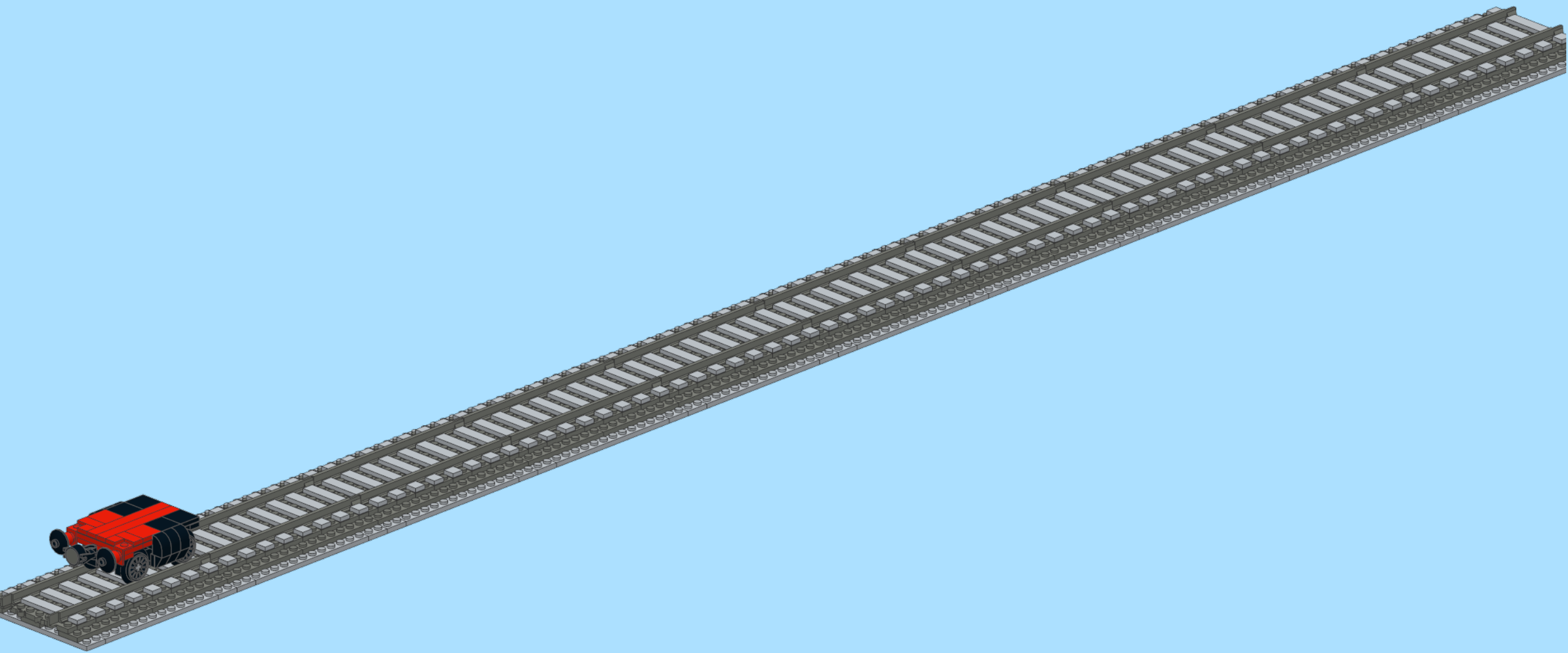

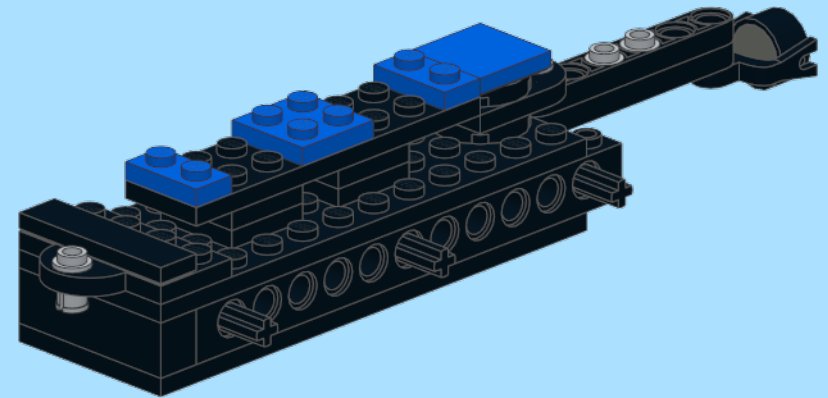
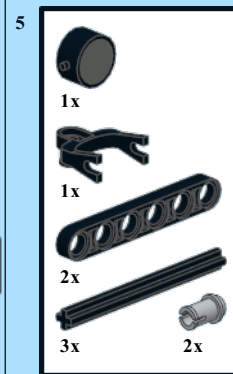
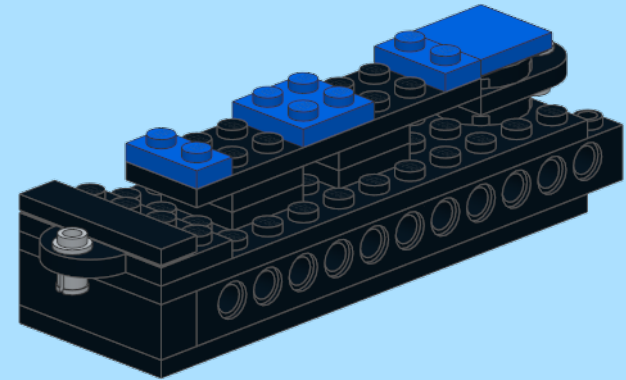
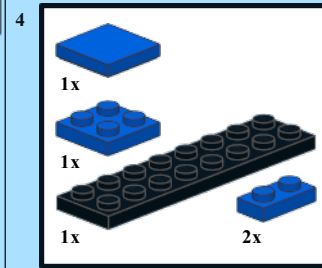
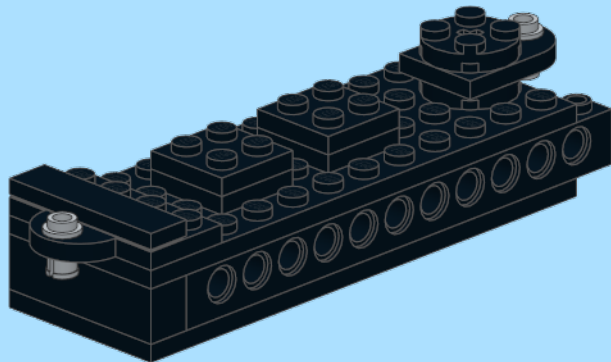
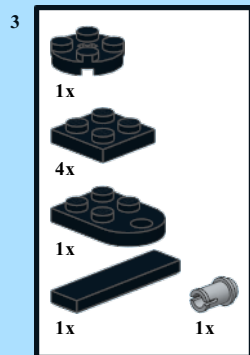
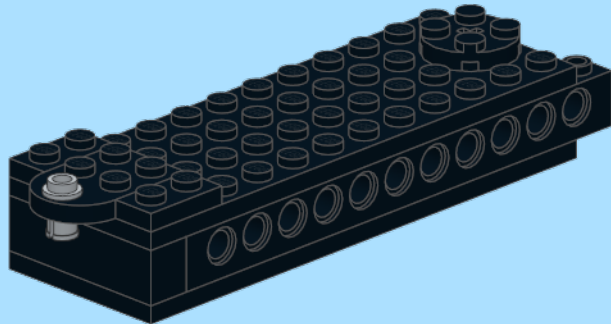
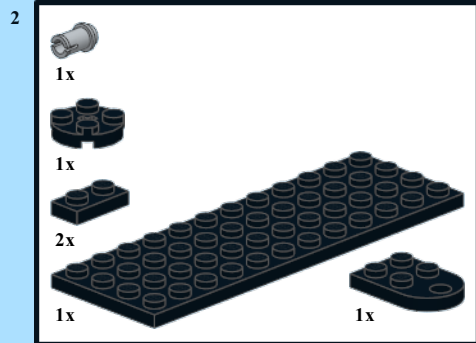
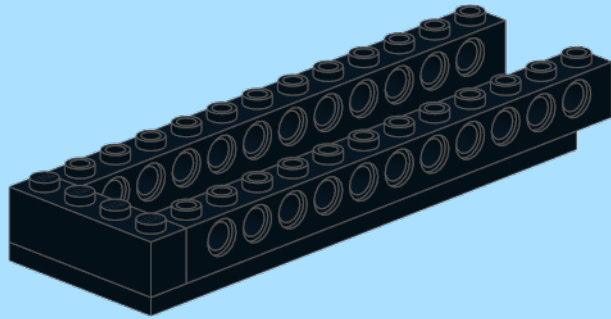
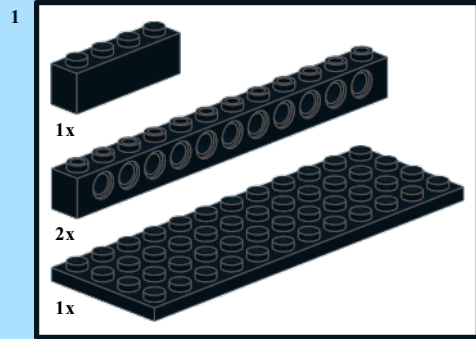

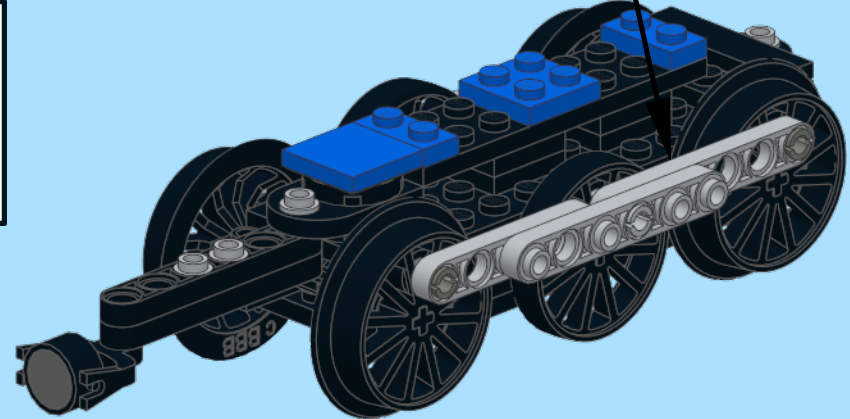
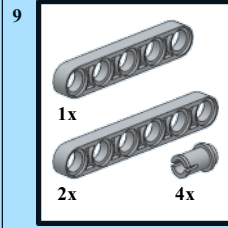
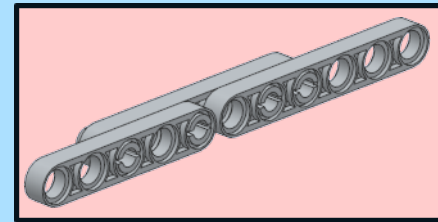
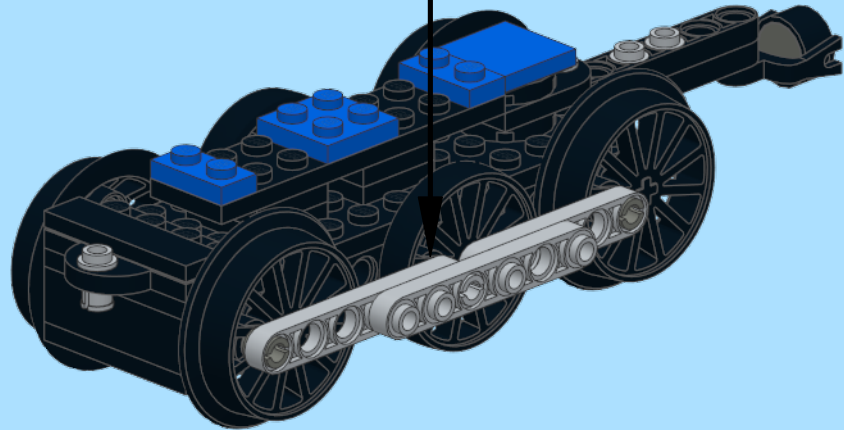
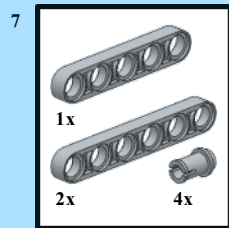
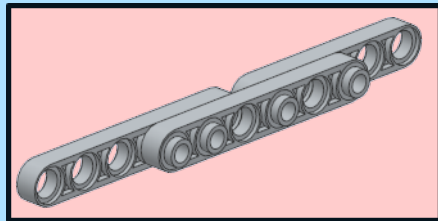
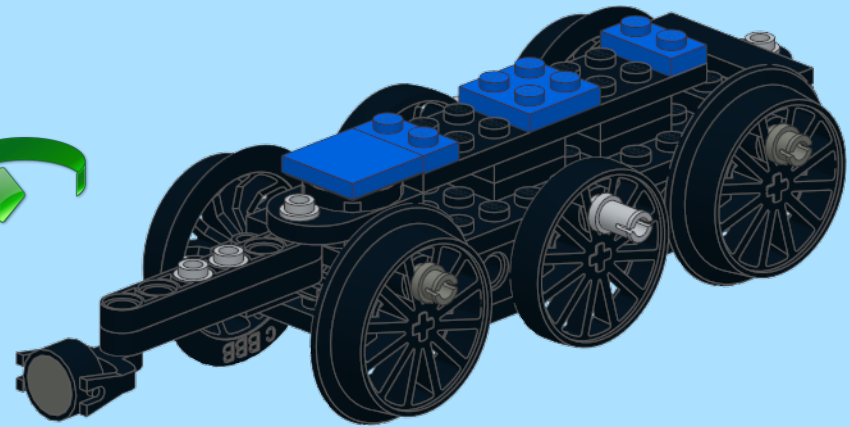
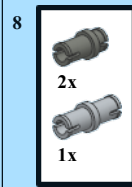
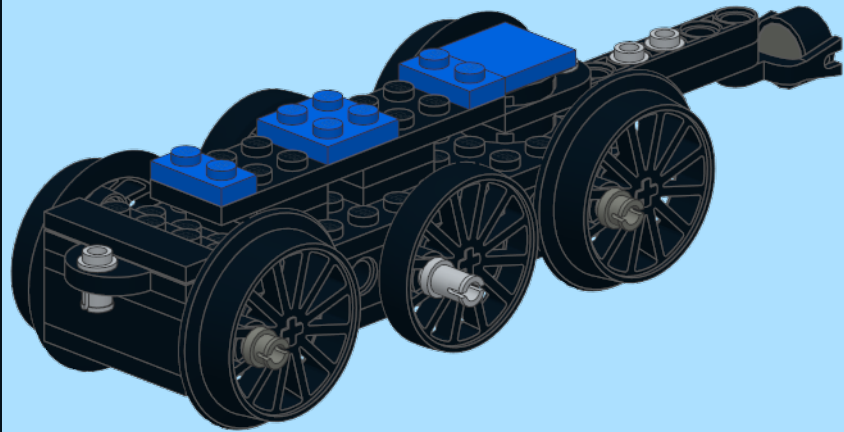
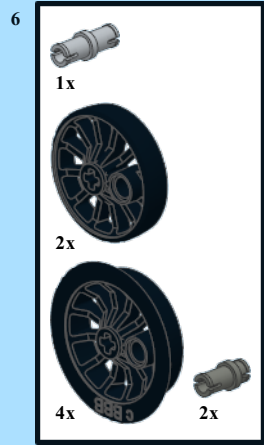

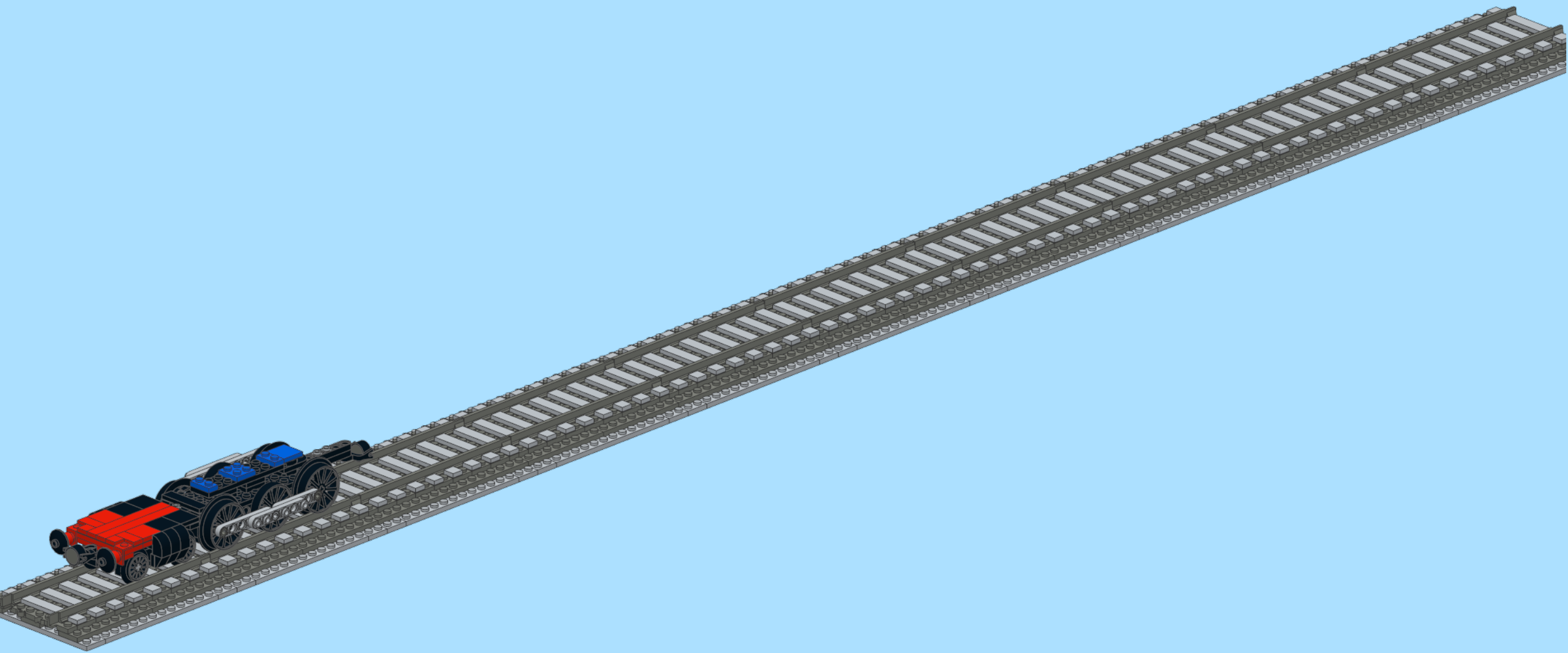

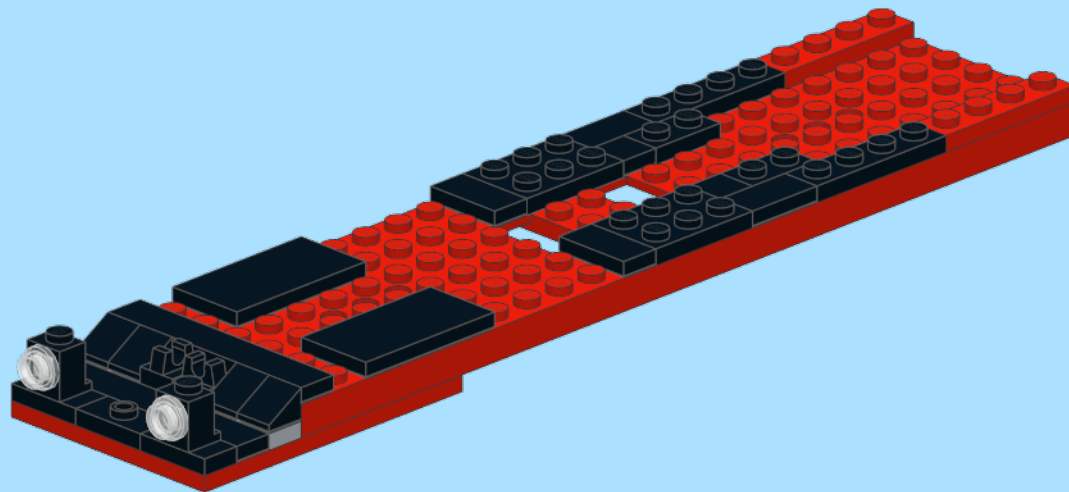
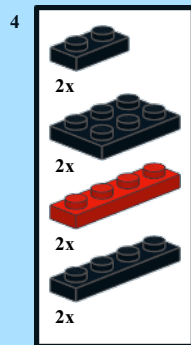
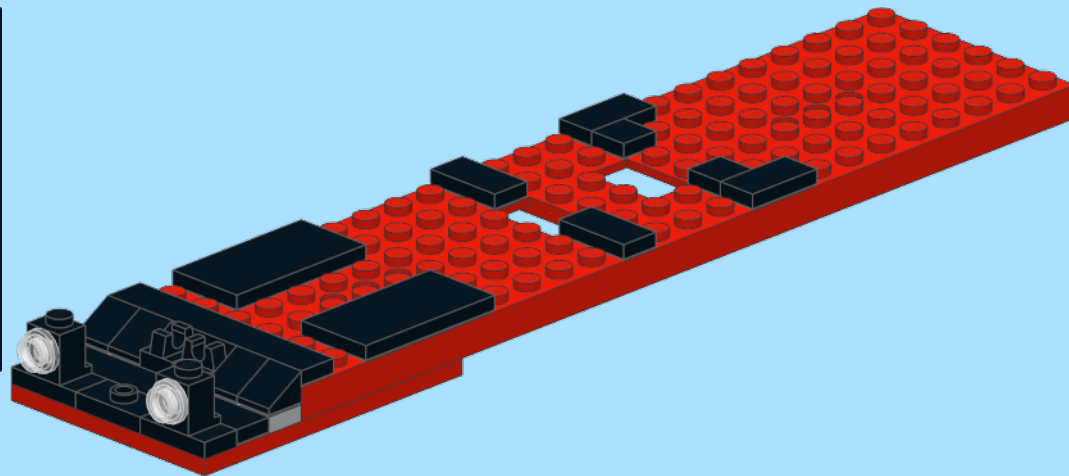
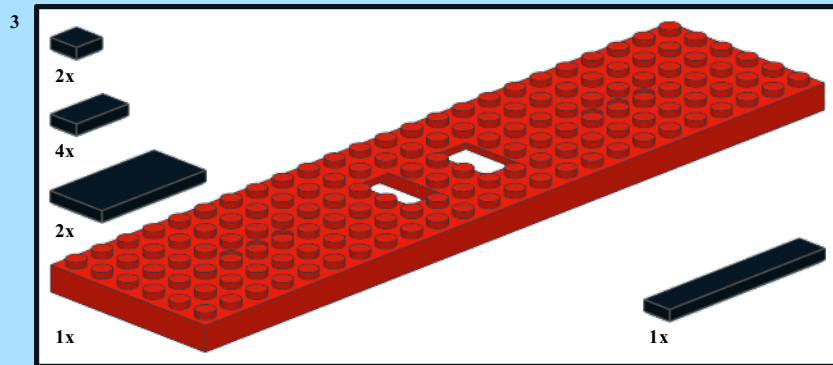
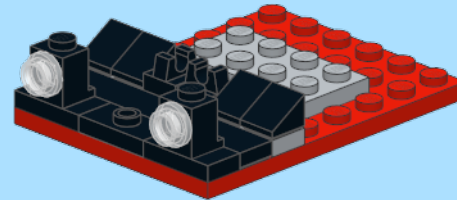
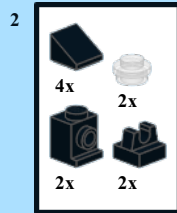
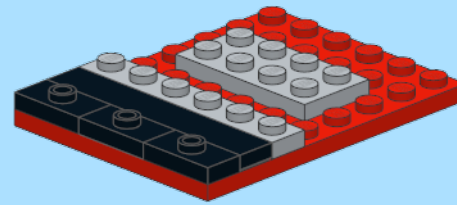
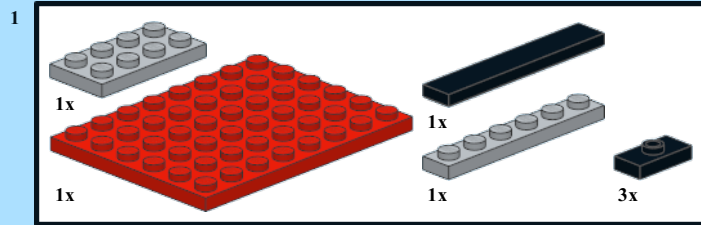

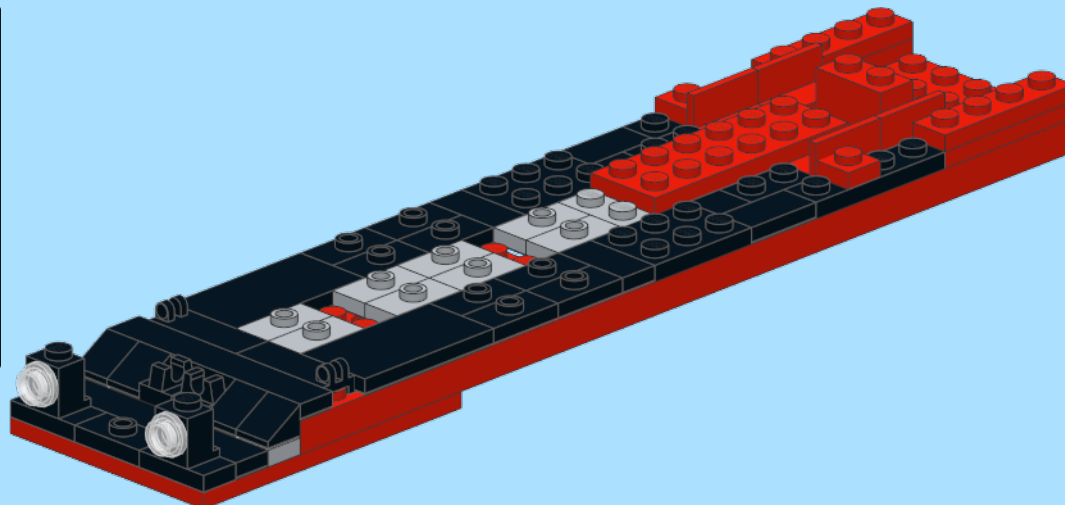
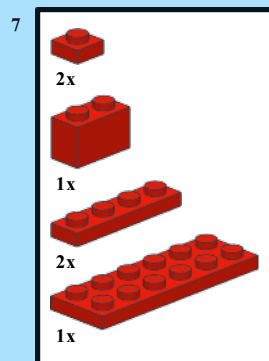
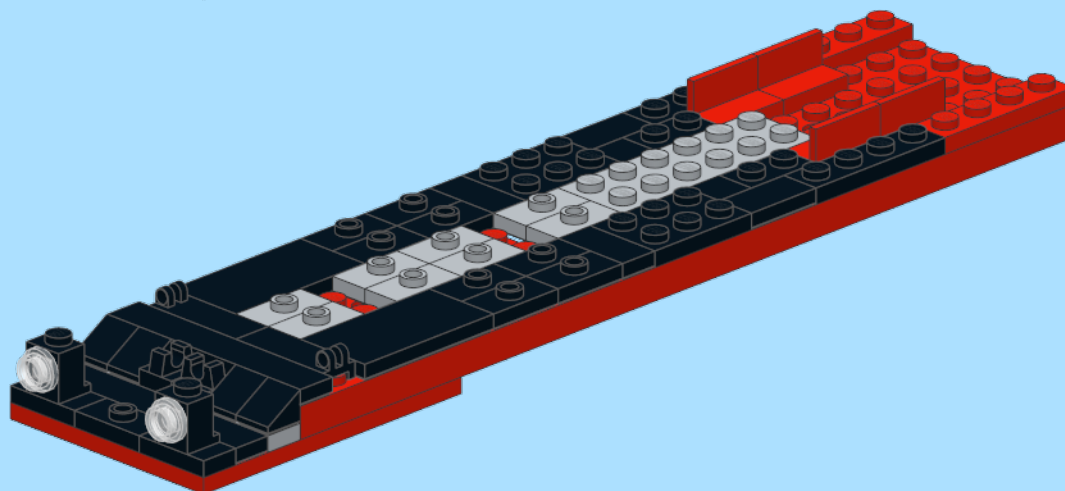
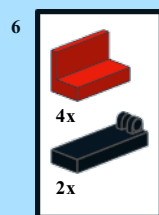
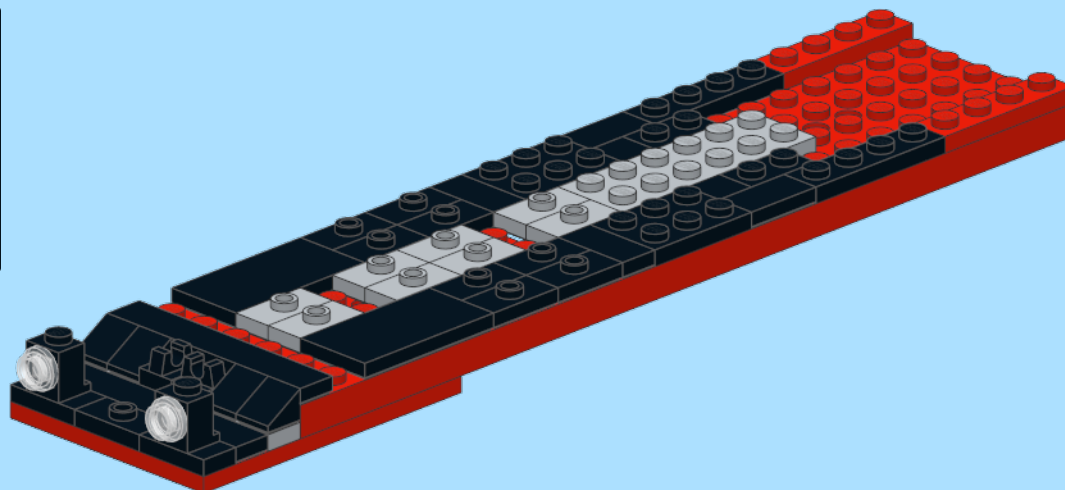
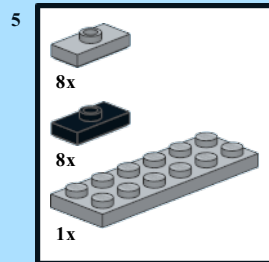

8

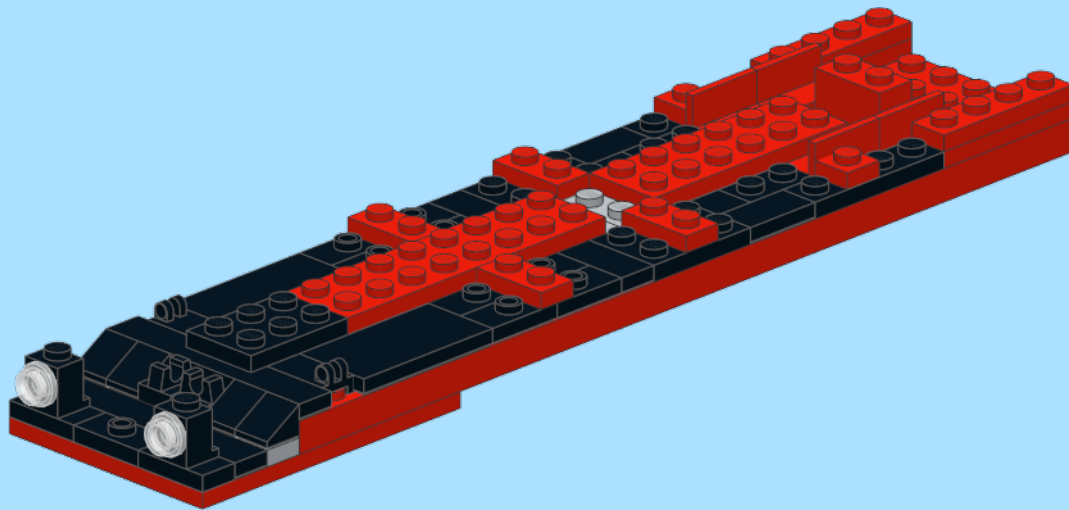
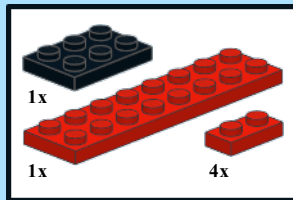

9

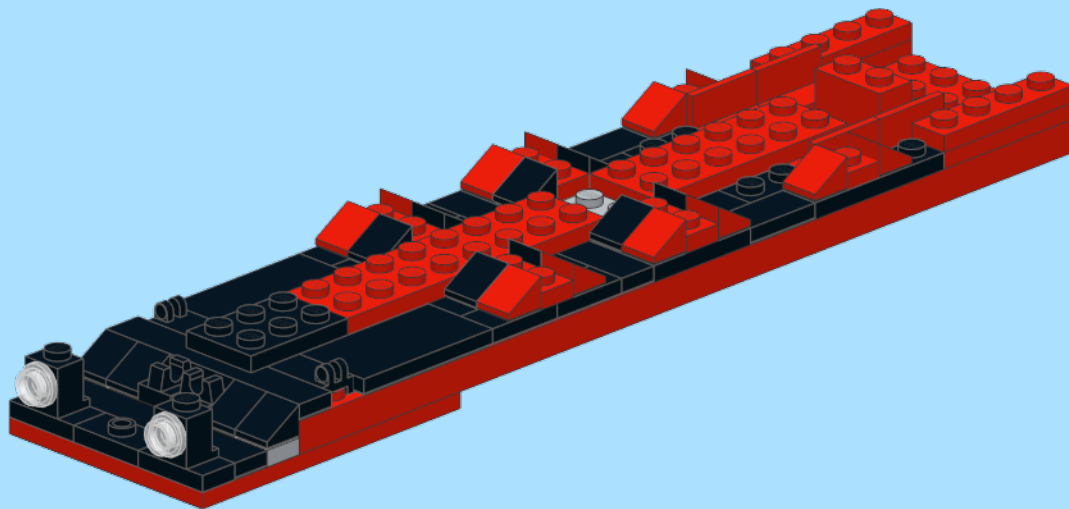

10

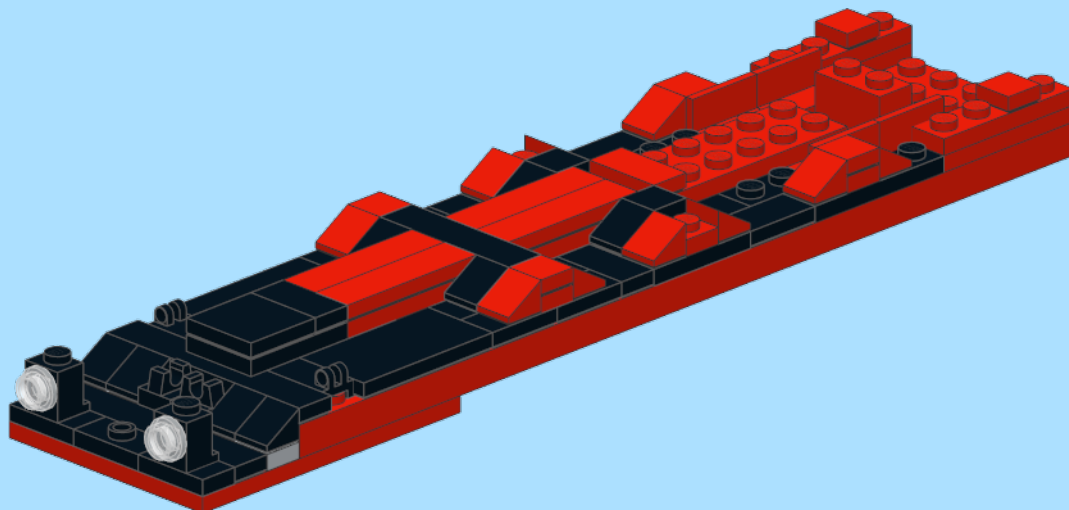
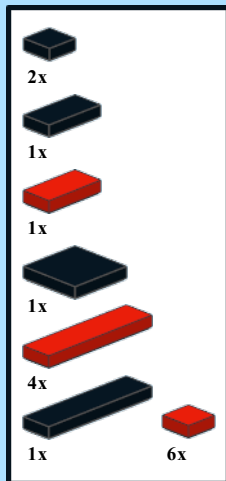



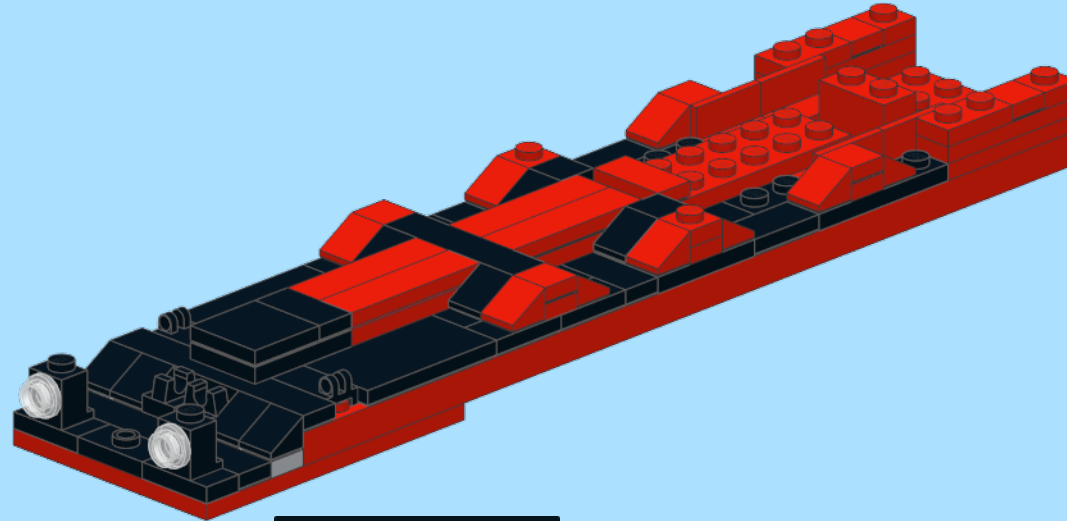
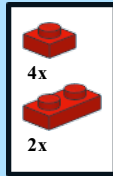



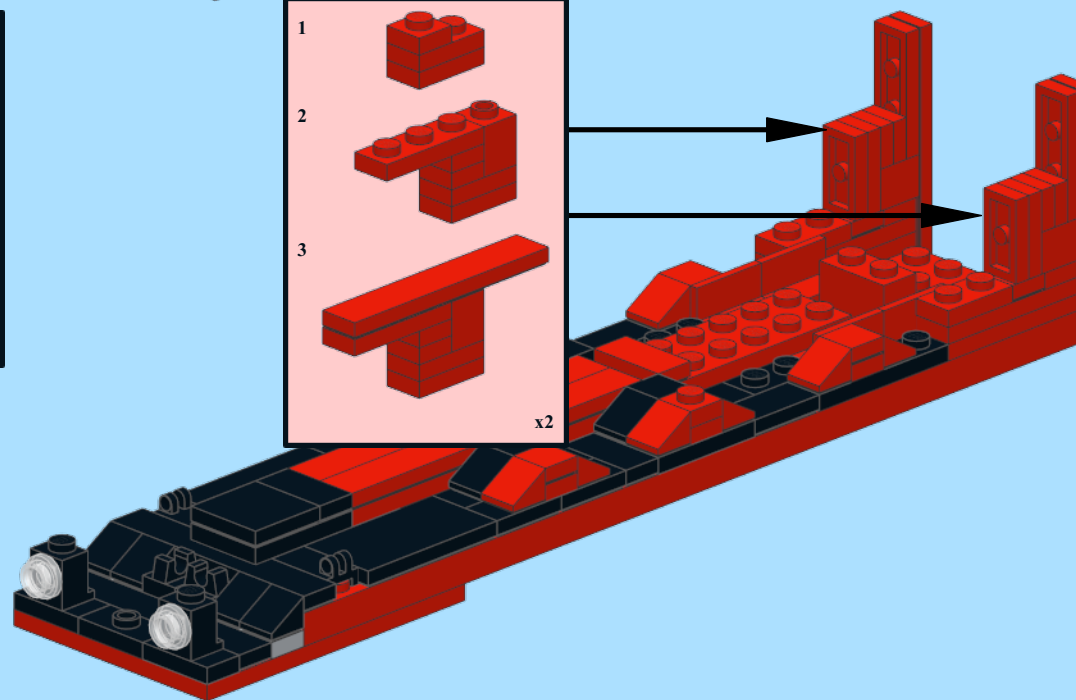
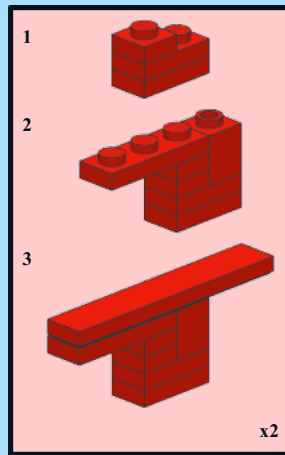
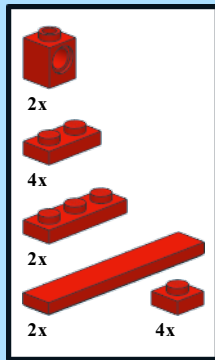

11



12



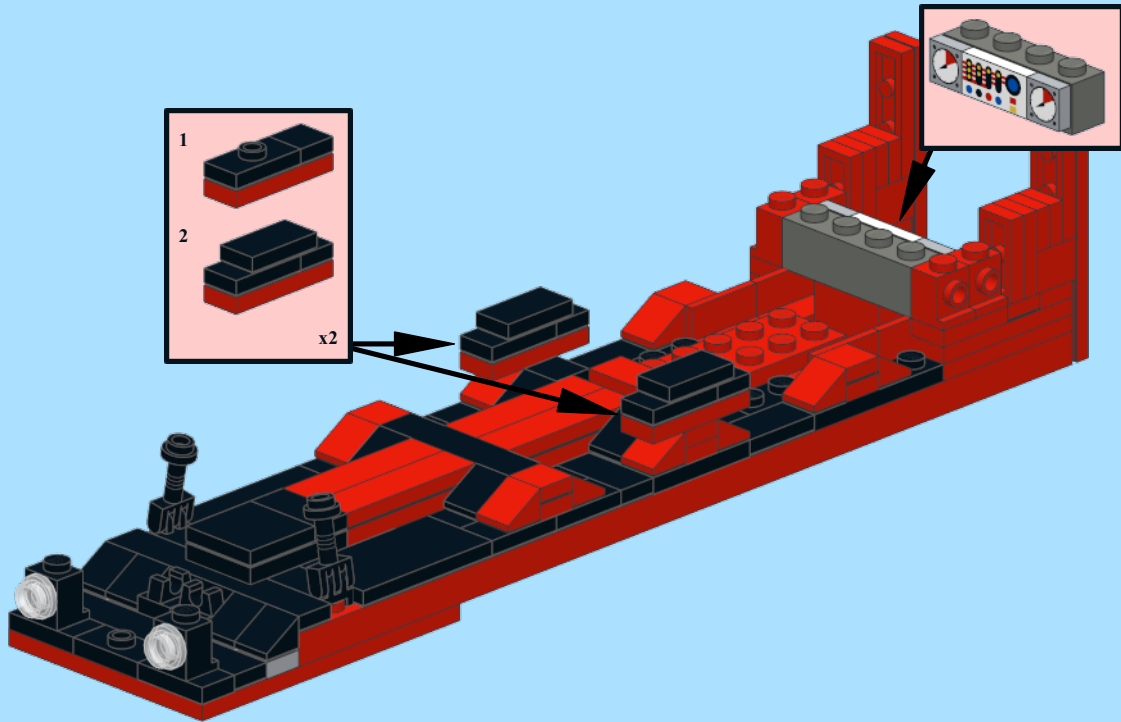
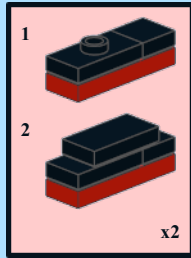

13

-  2x
-  2x
-  4x
-  2x
-  1x
-  2x
-  2x
-  1x
-  2x



14

-  2x
-  2x

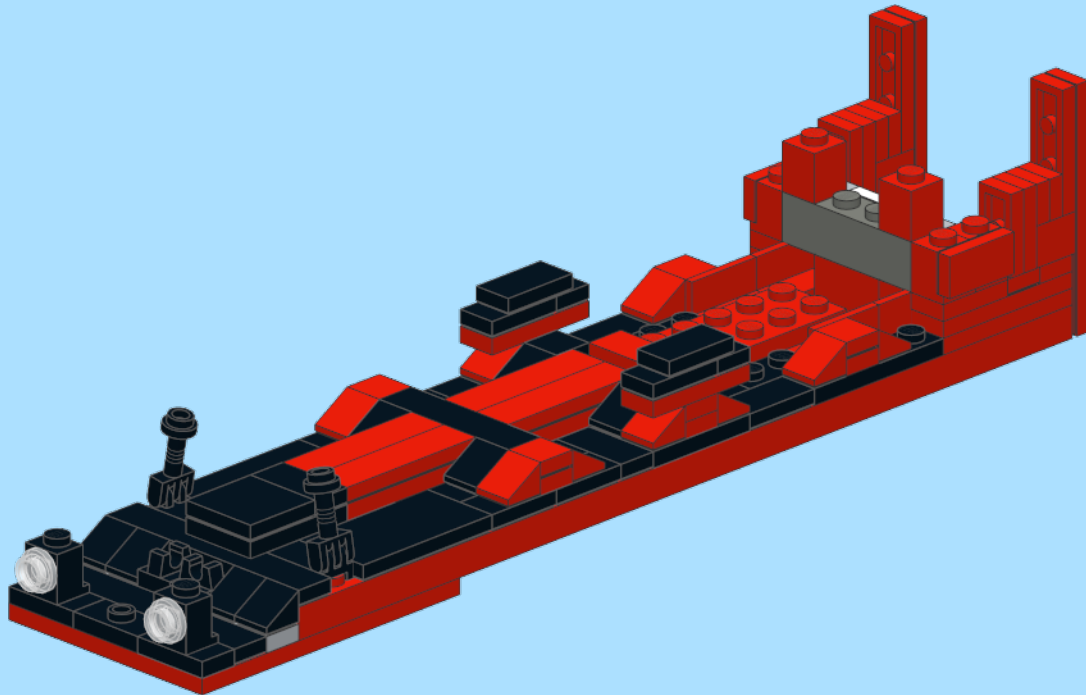

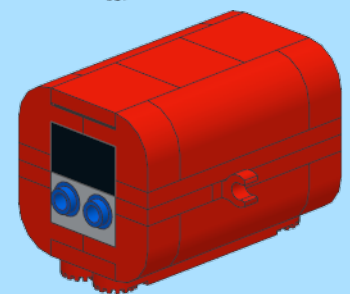
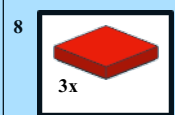
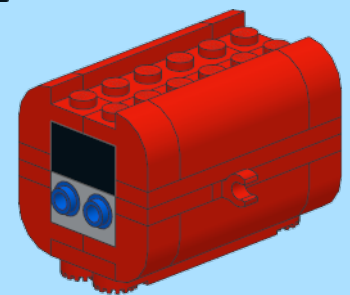
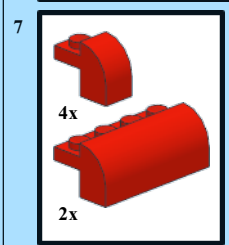
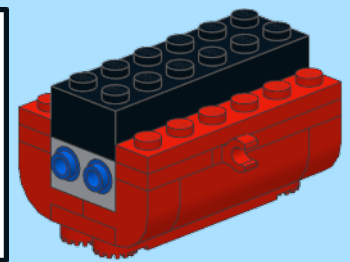
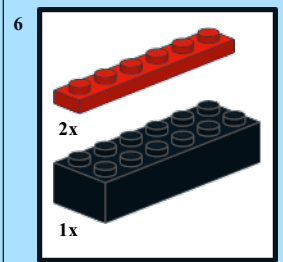
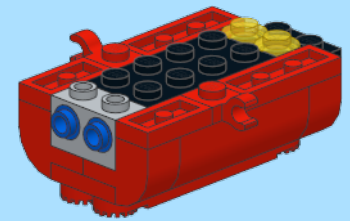
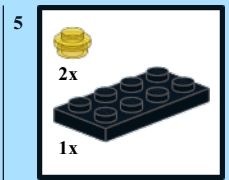
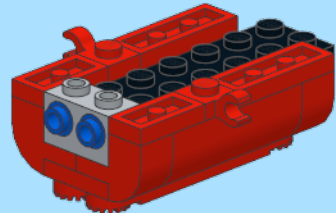
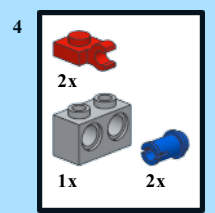
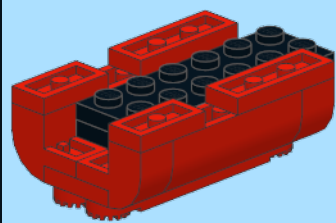
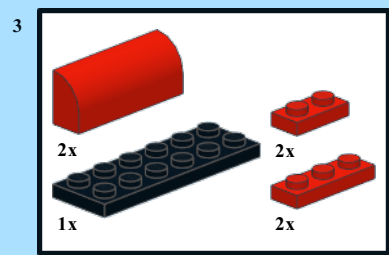
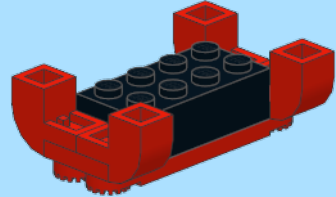
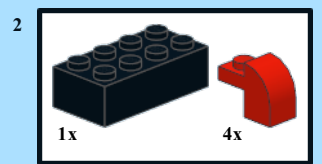
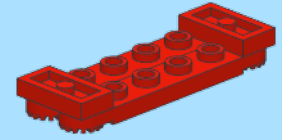
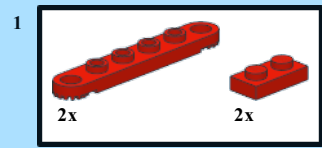

15

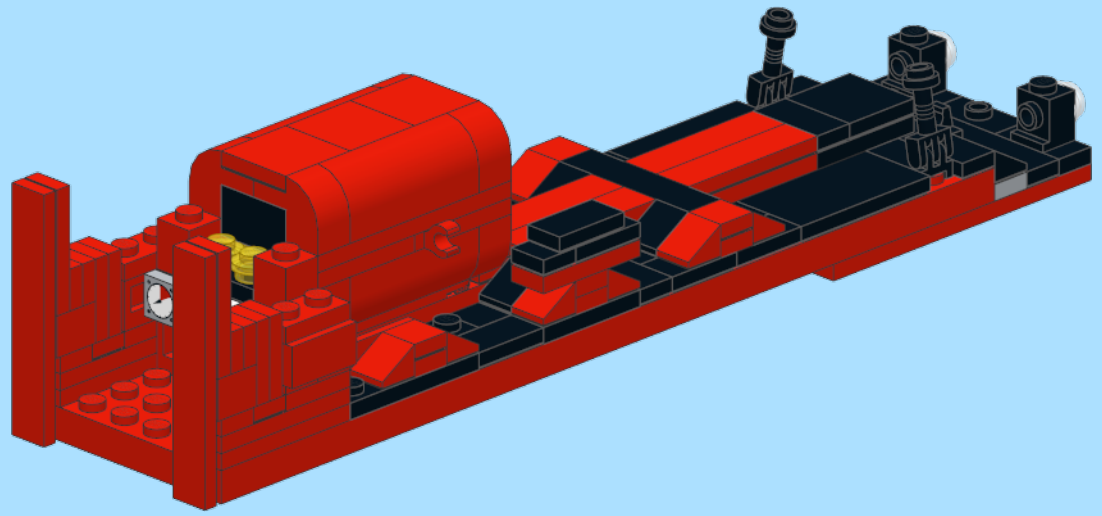

16

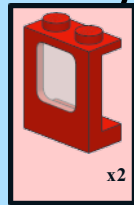
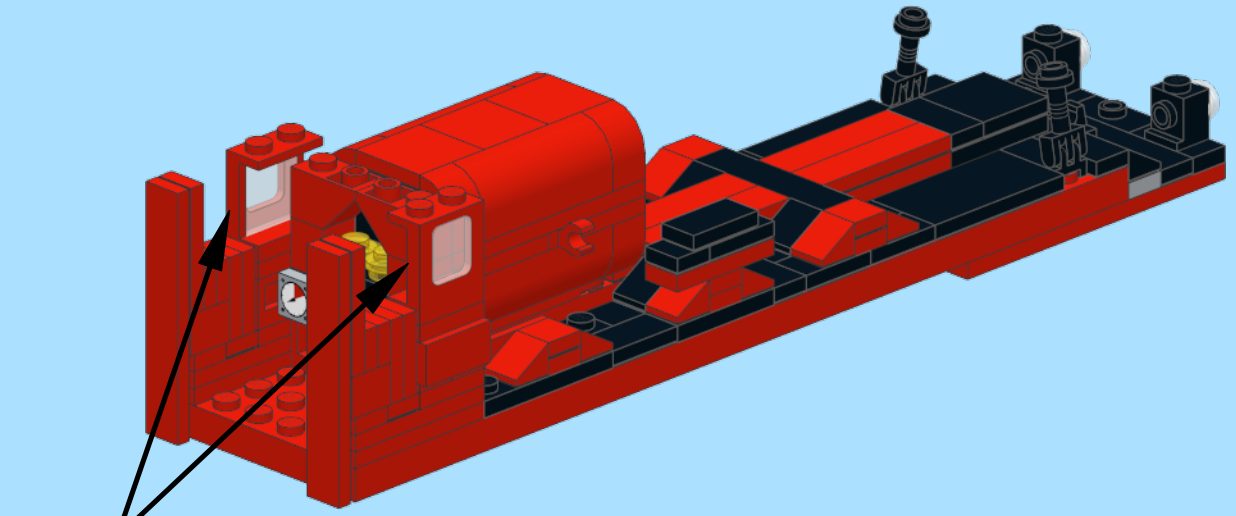

17

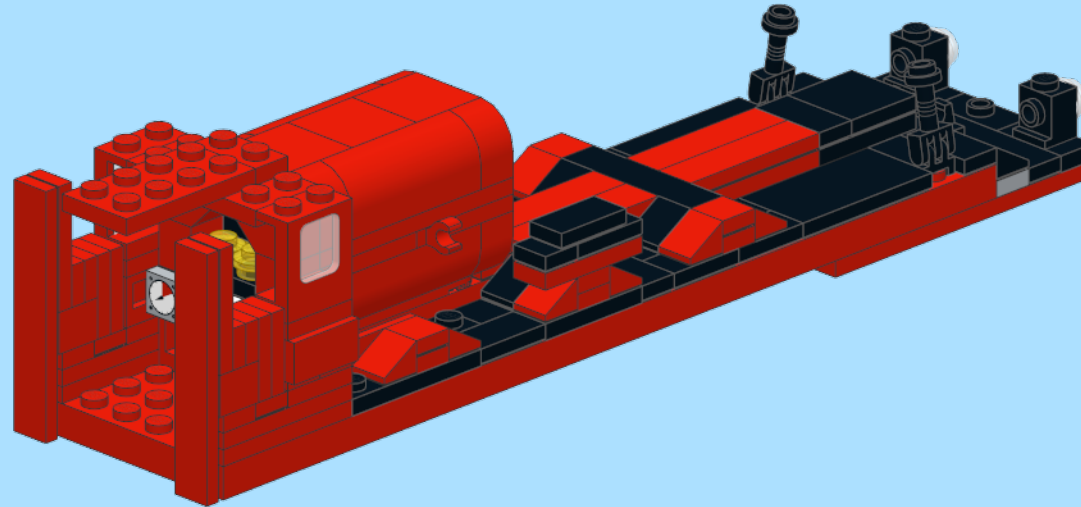
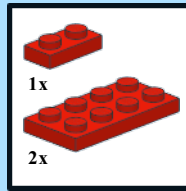

18

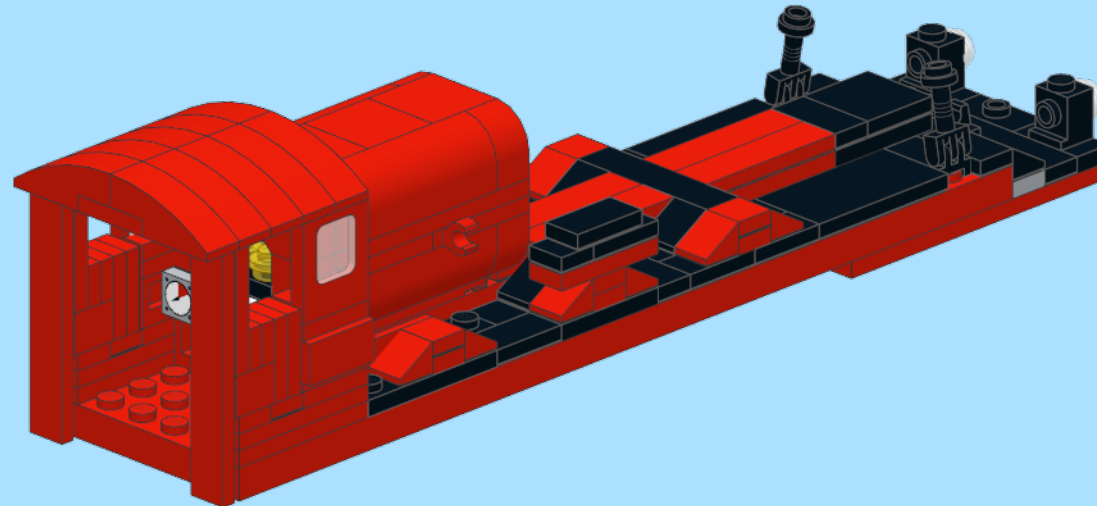
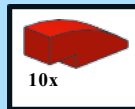

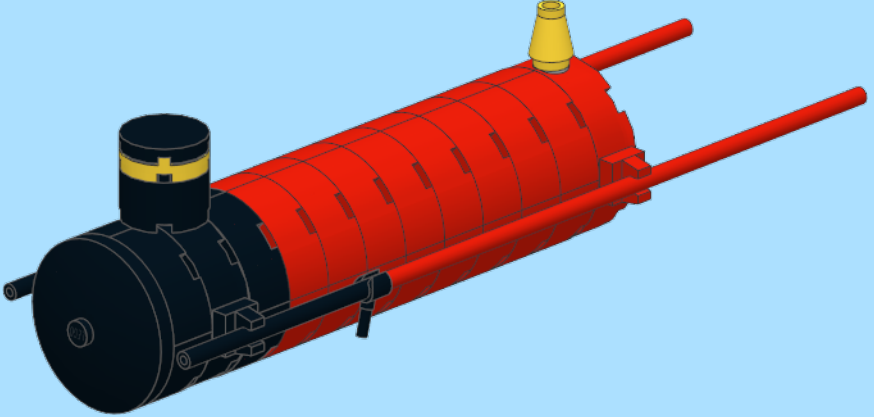
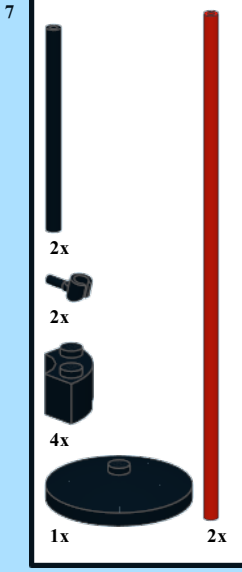
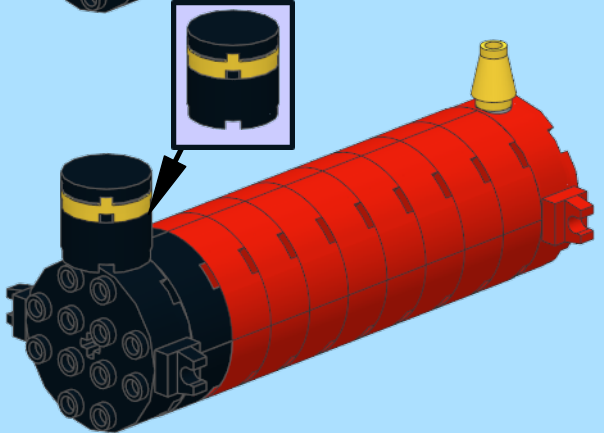
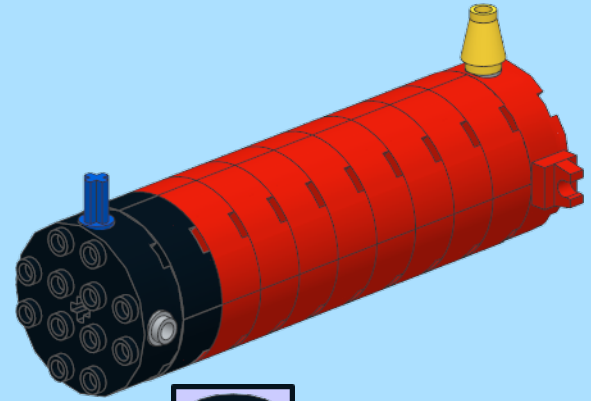
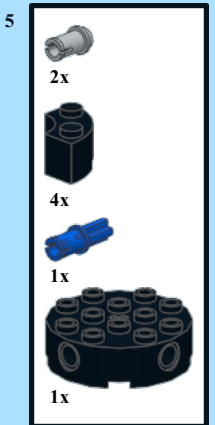
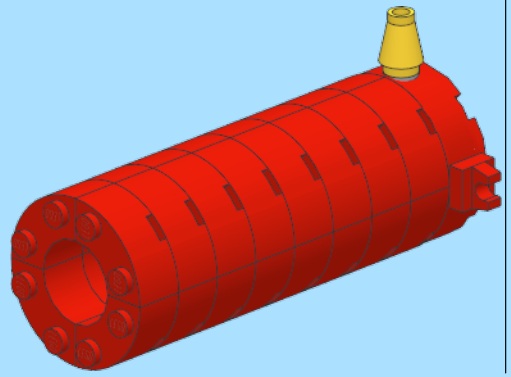
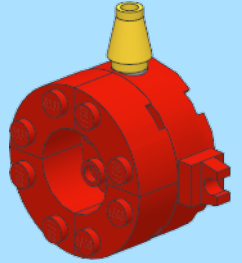
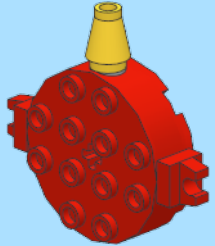
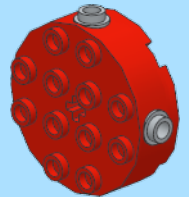
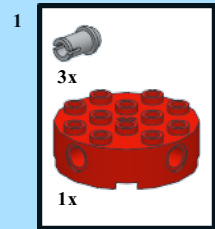

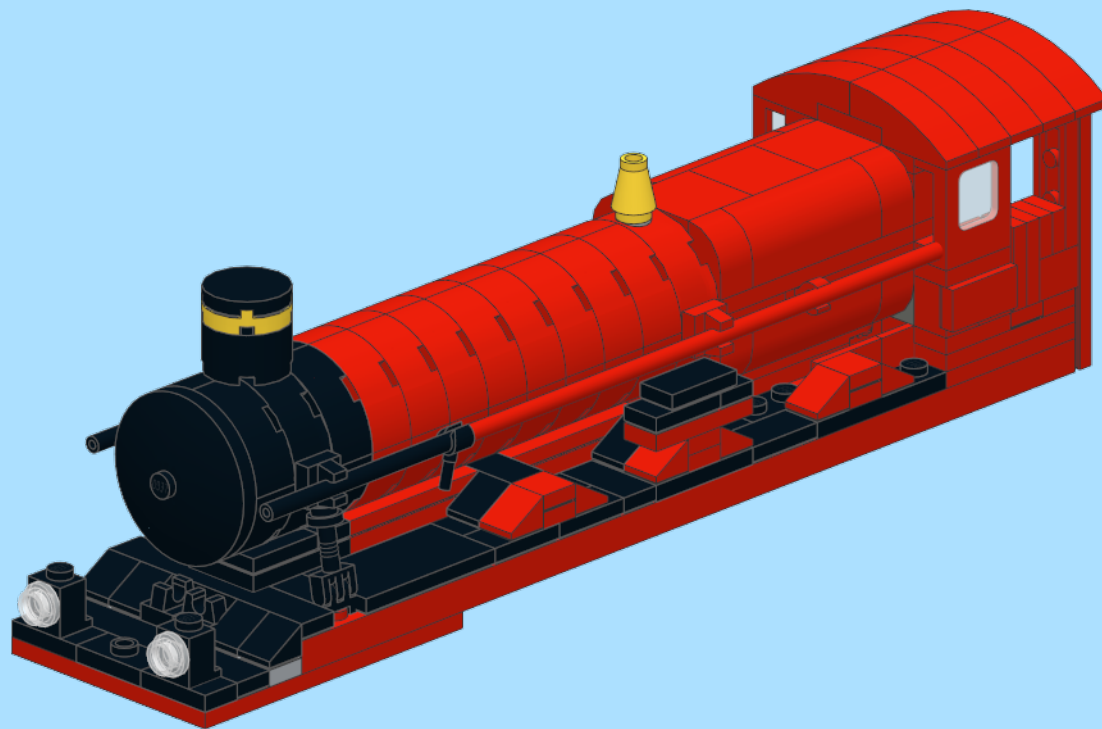

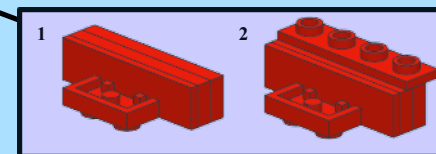
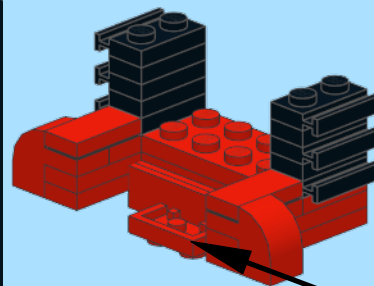
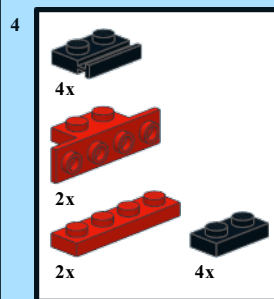
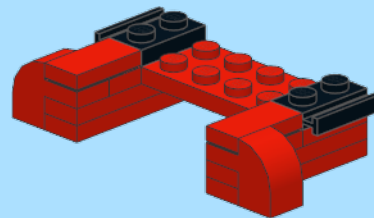
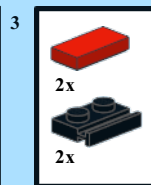
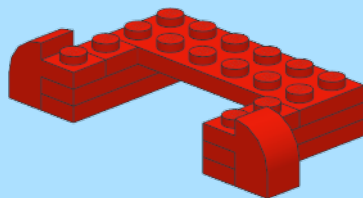
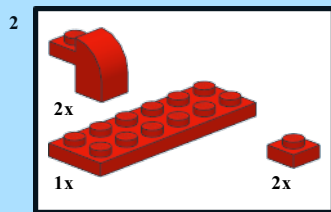
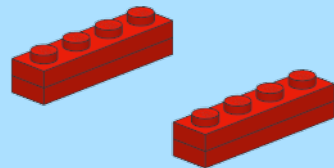
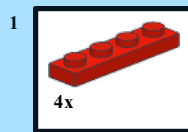

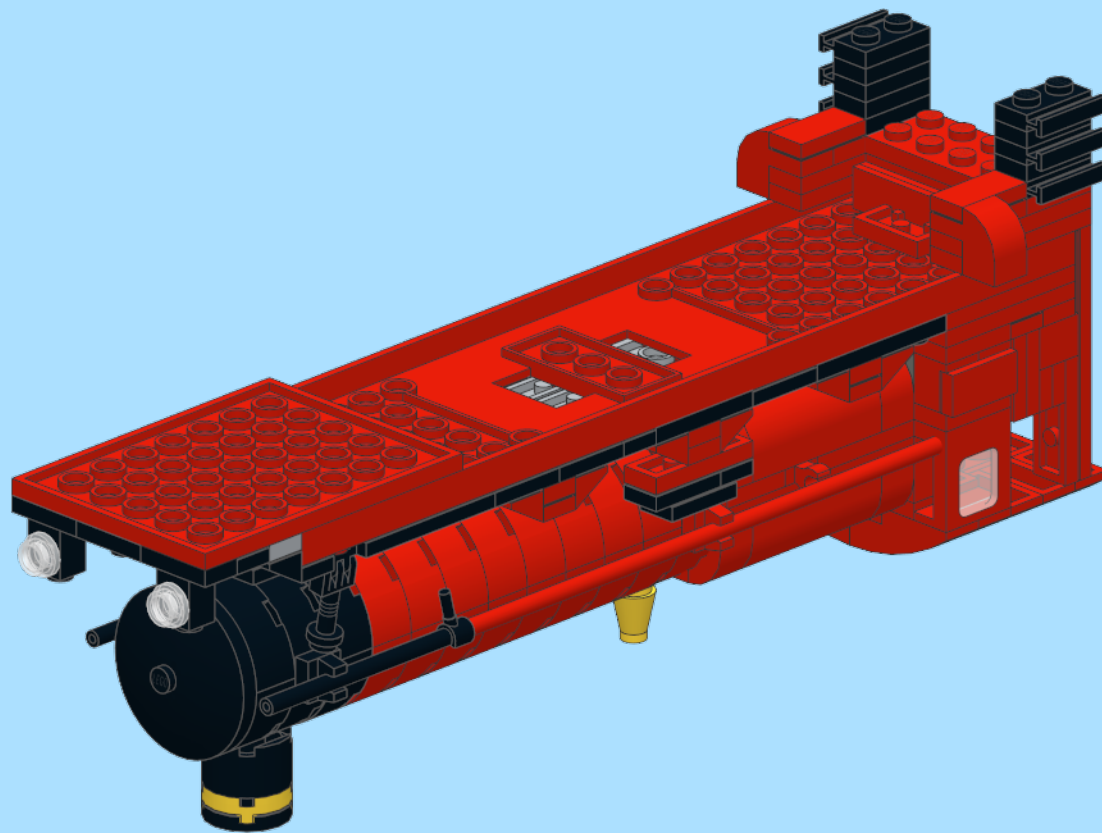

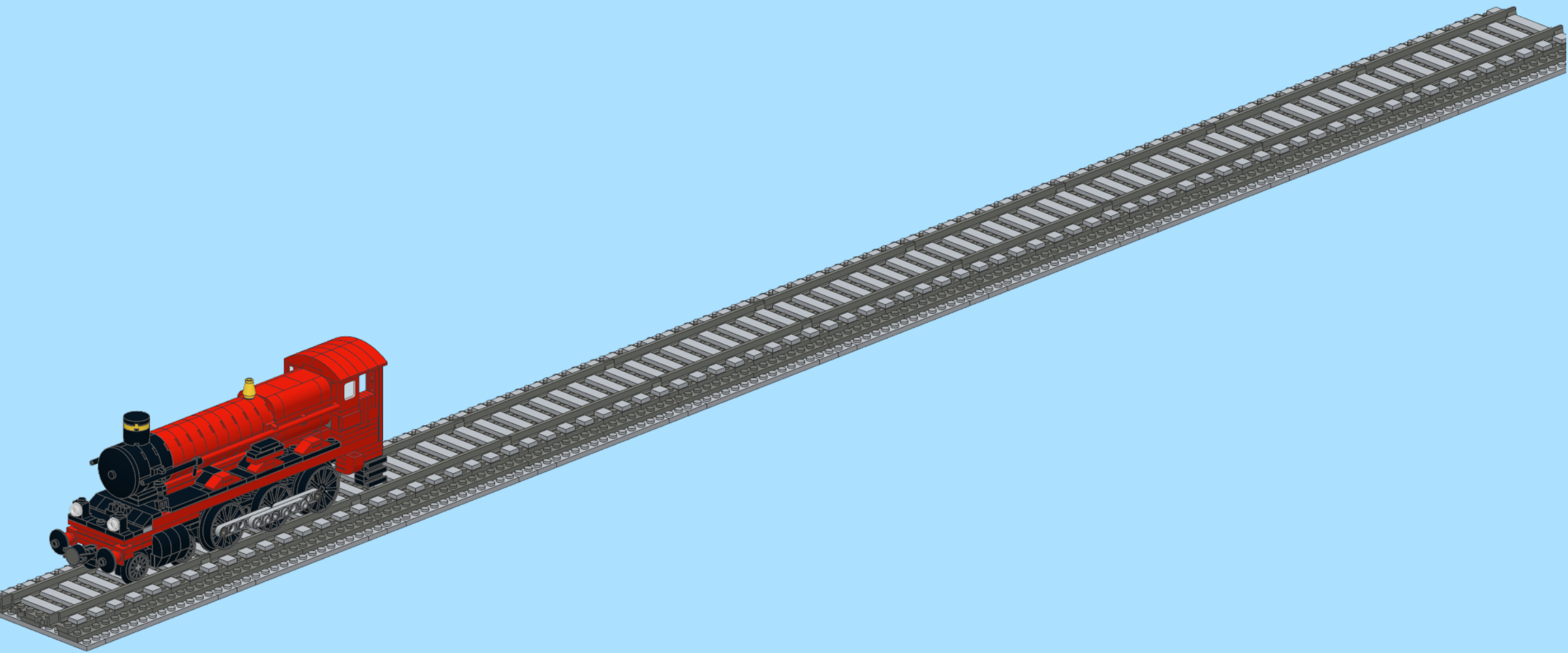

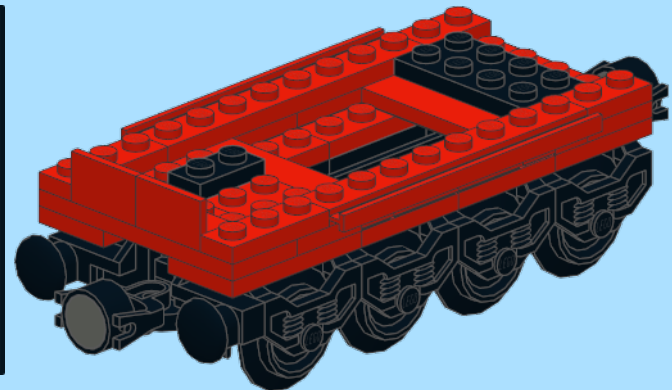
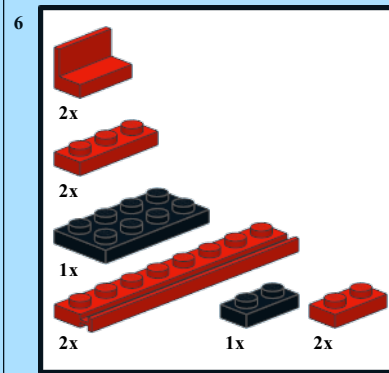
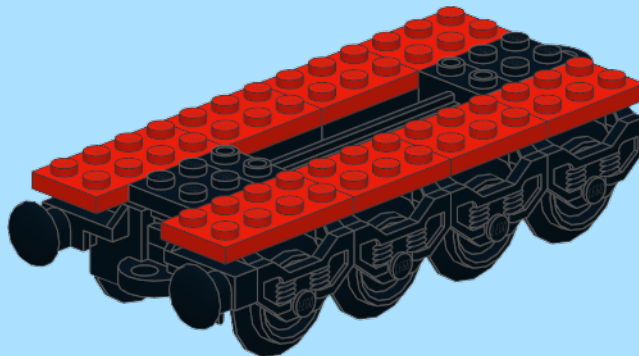
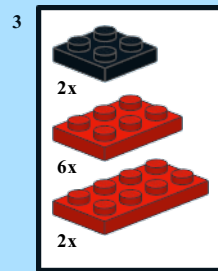
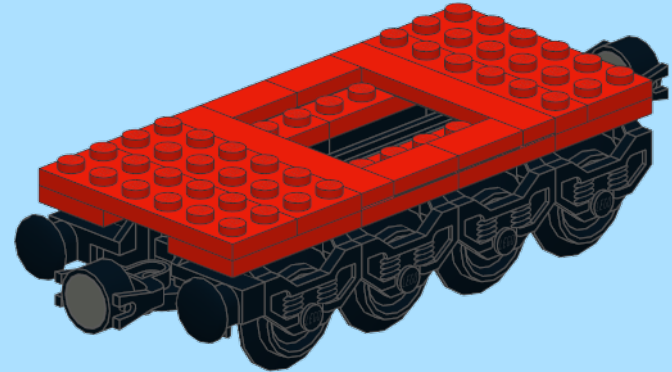
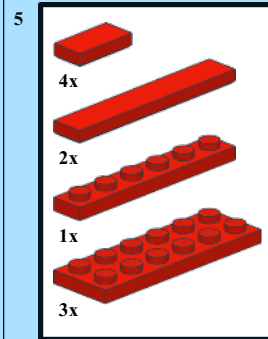
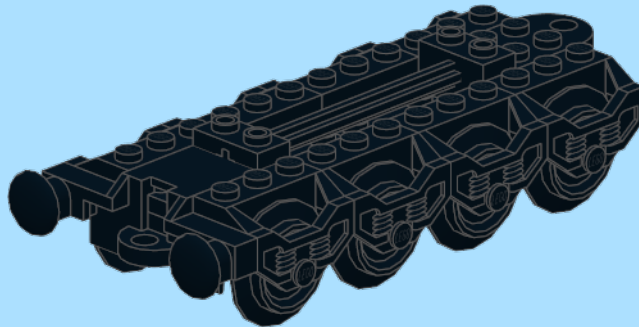
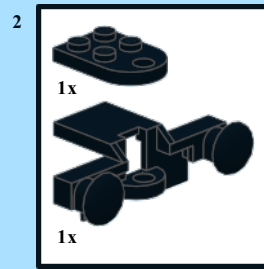
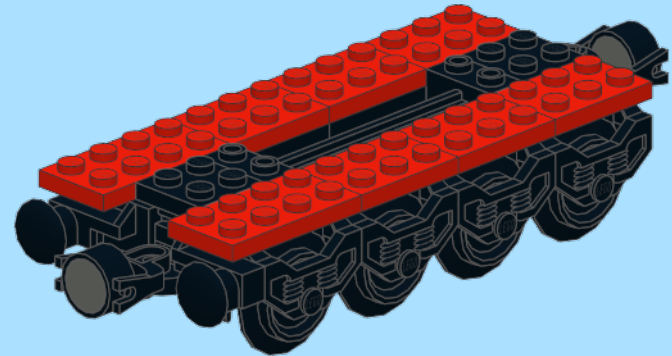
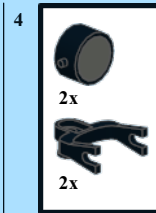
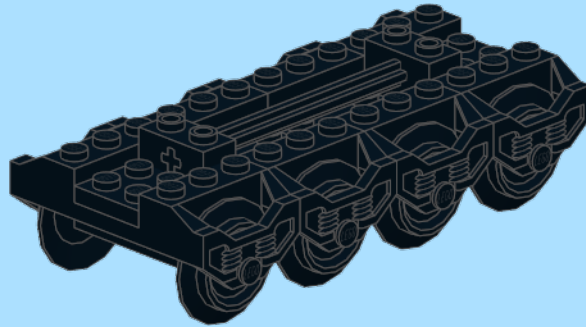
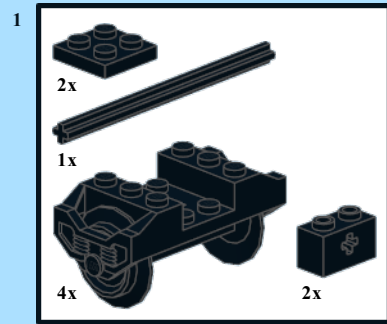

7

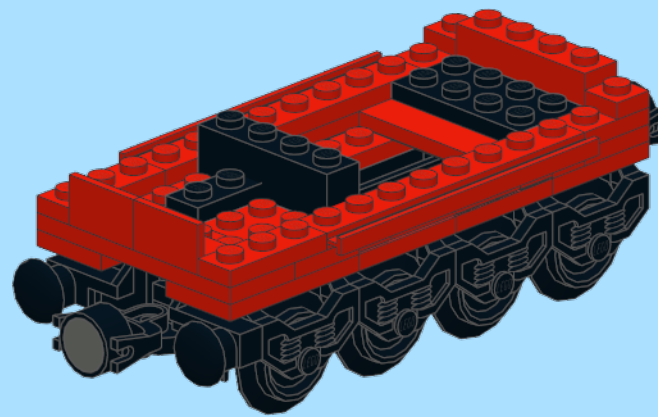
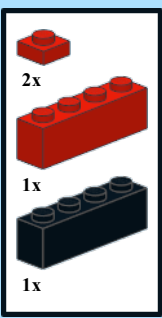

10

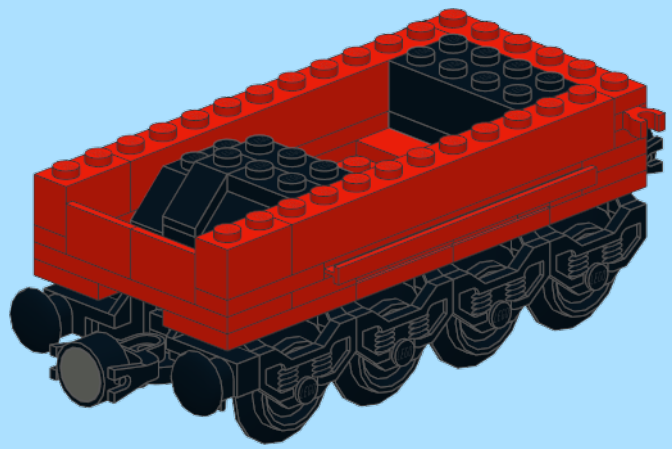
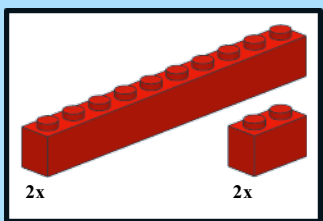

8

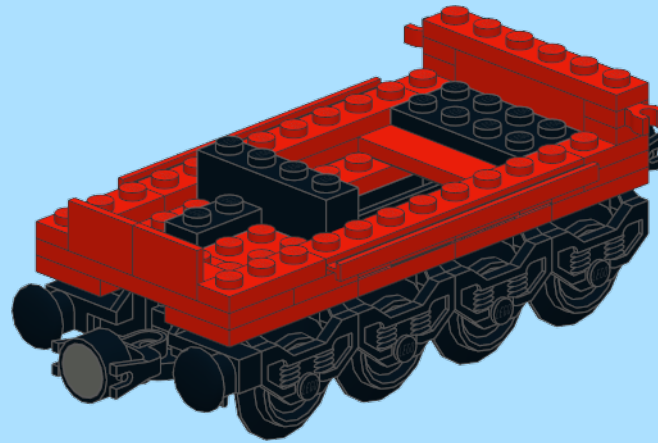
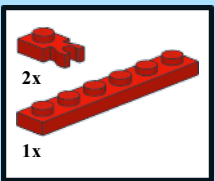

11

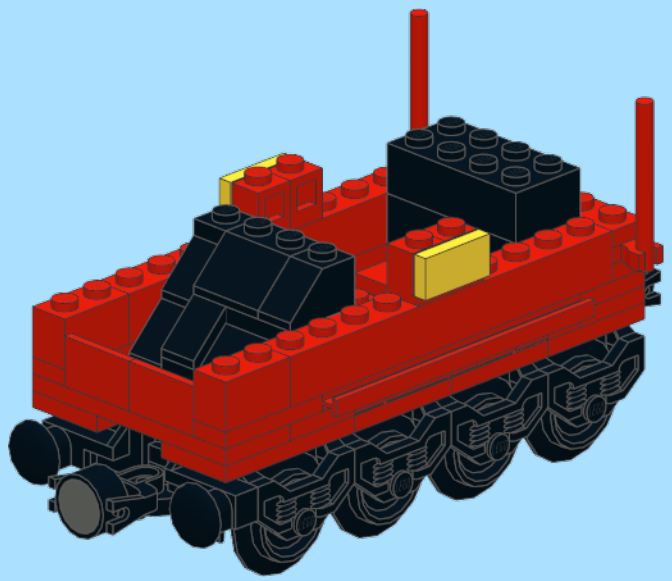
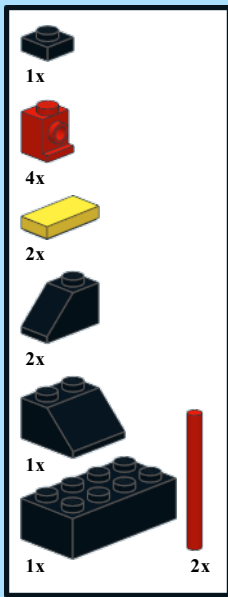

9

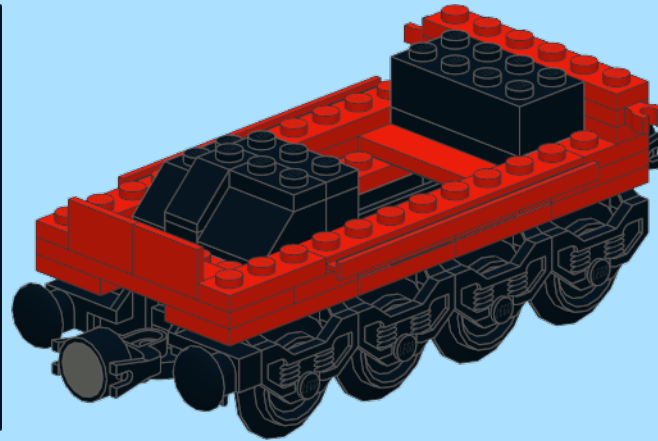
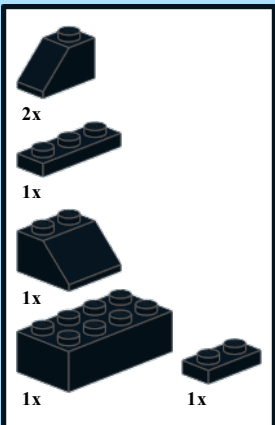

12

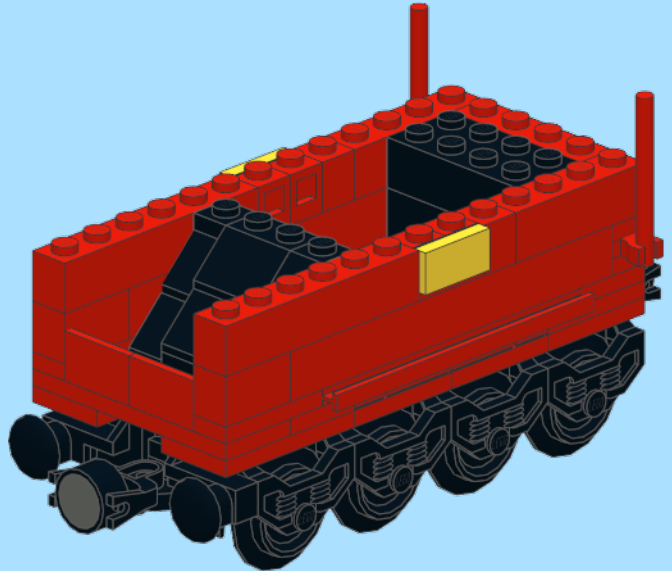
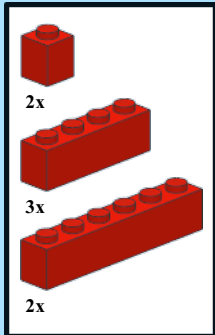

13

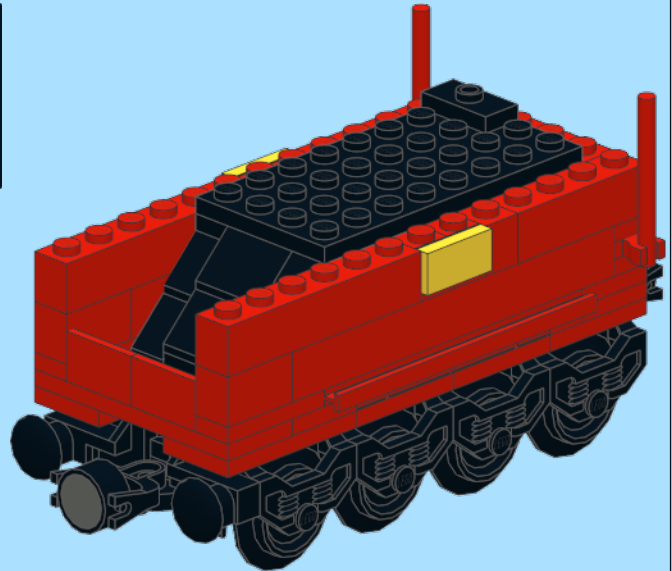
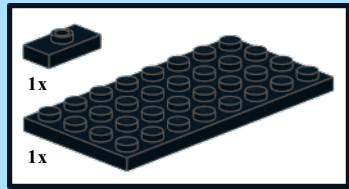

15

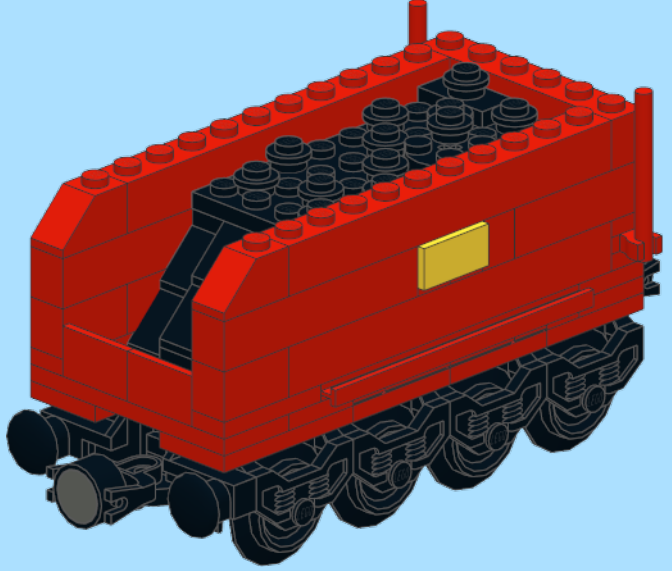
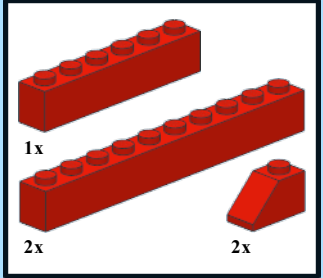

14

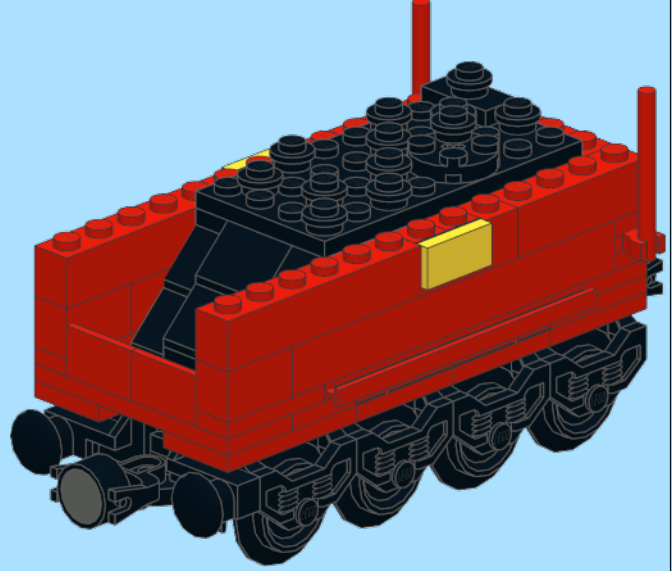

16

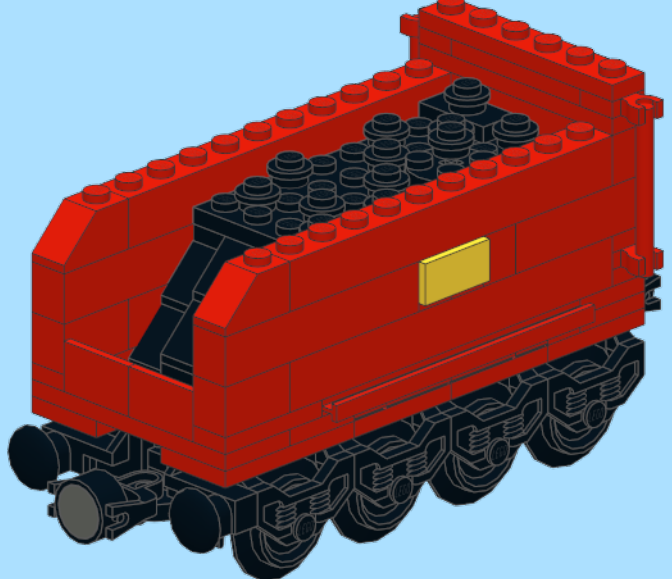
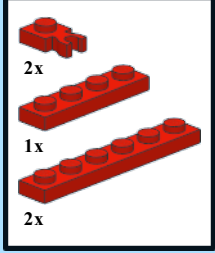

17

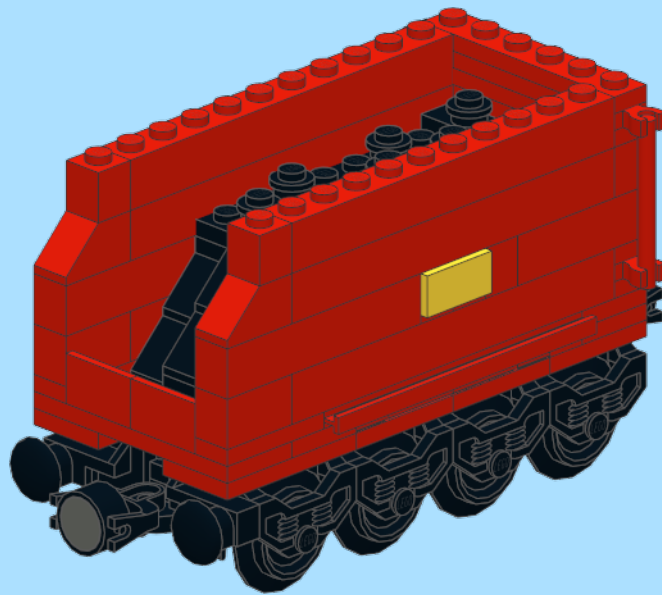
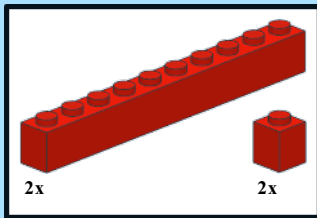

18

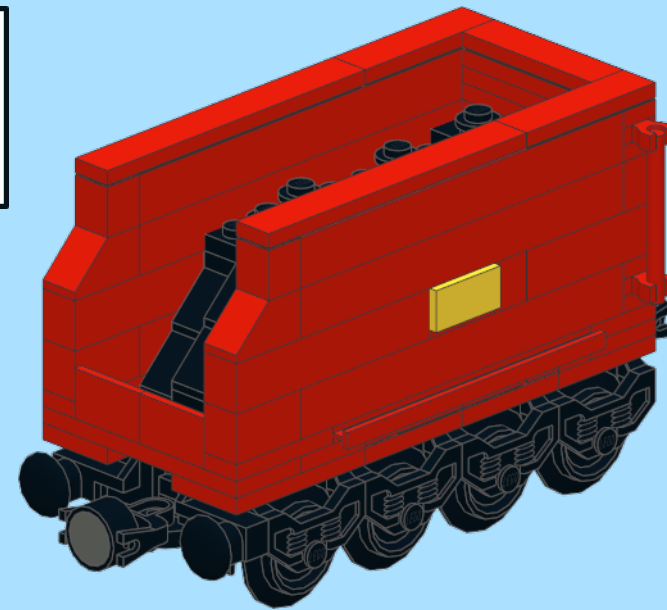
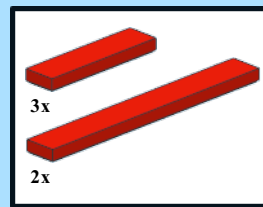

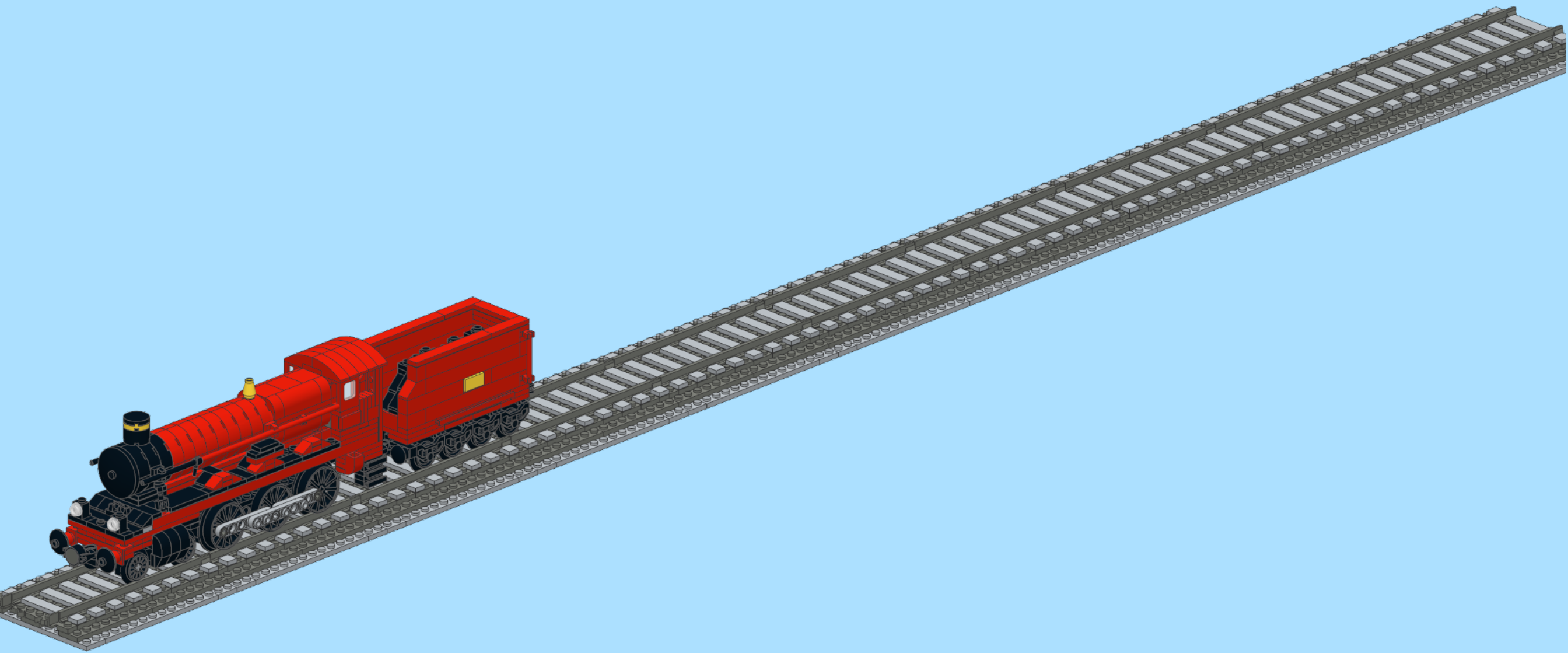

1

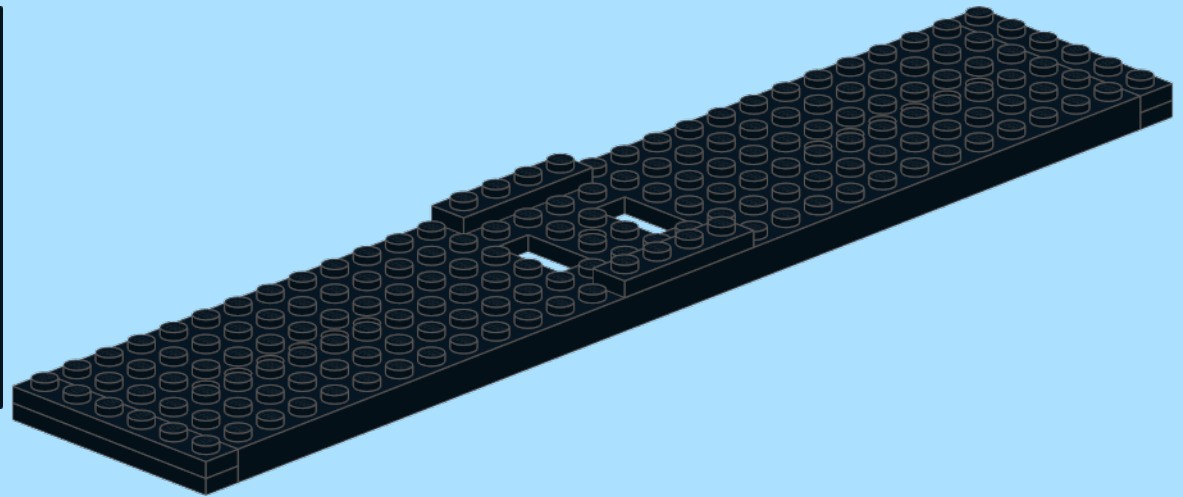
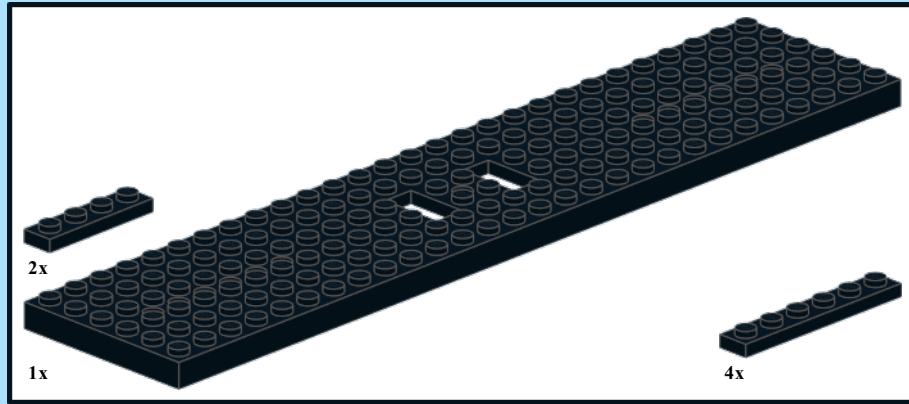

2

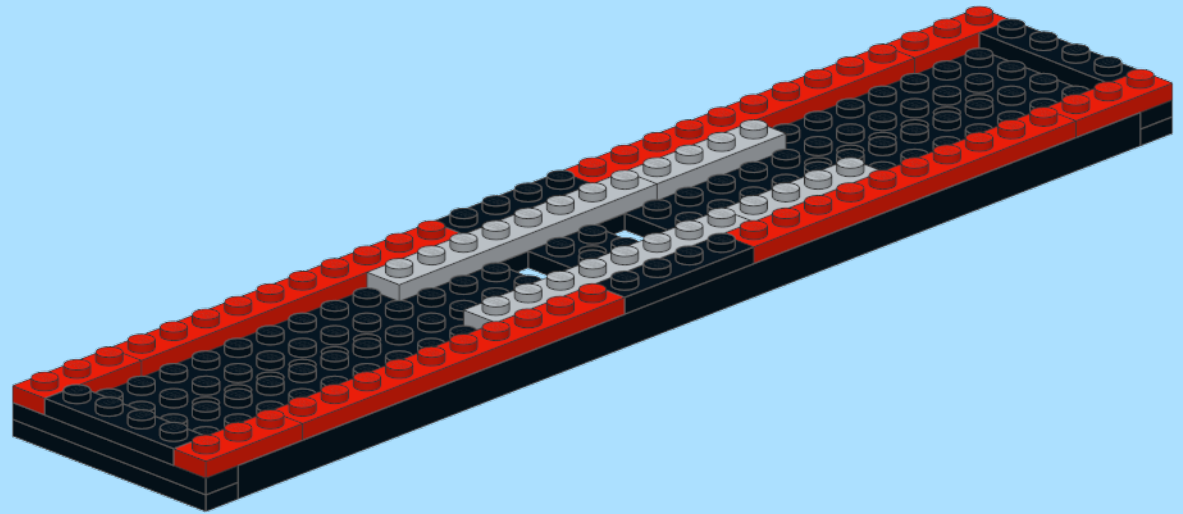
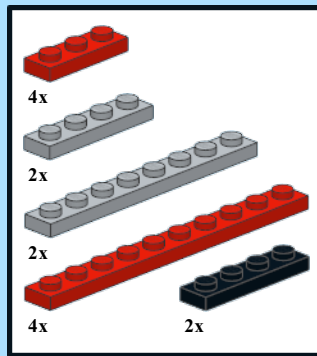

3

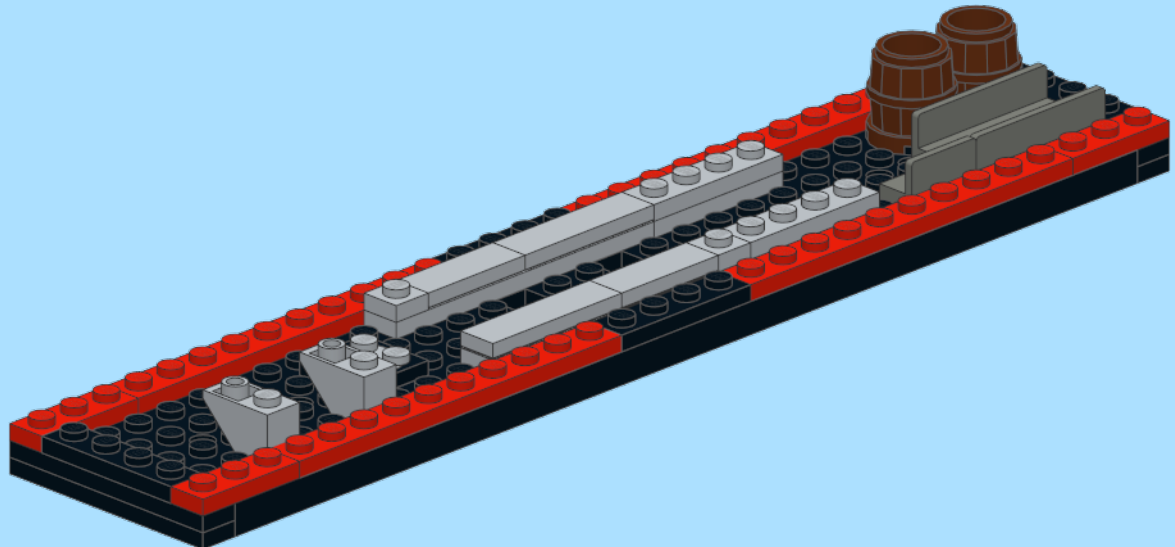
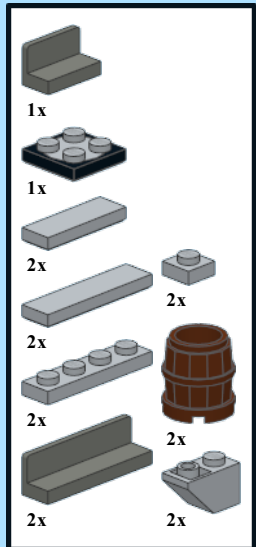

4

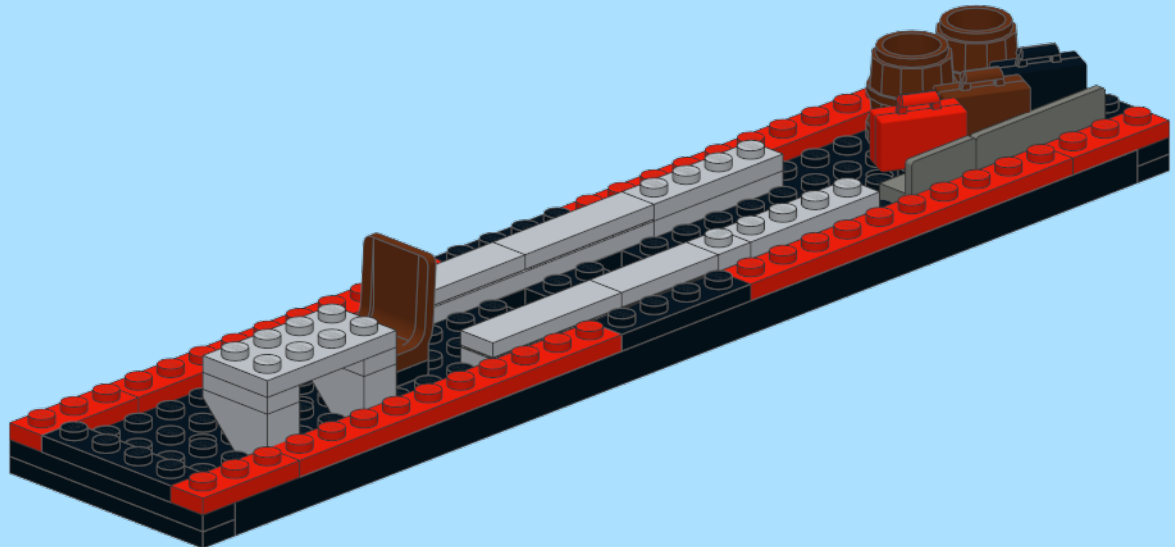
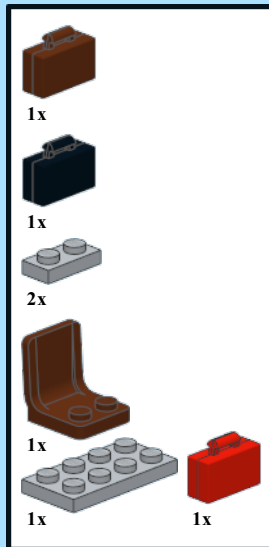

5

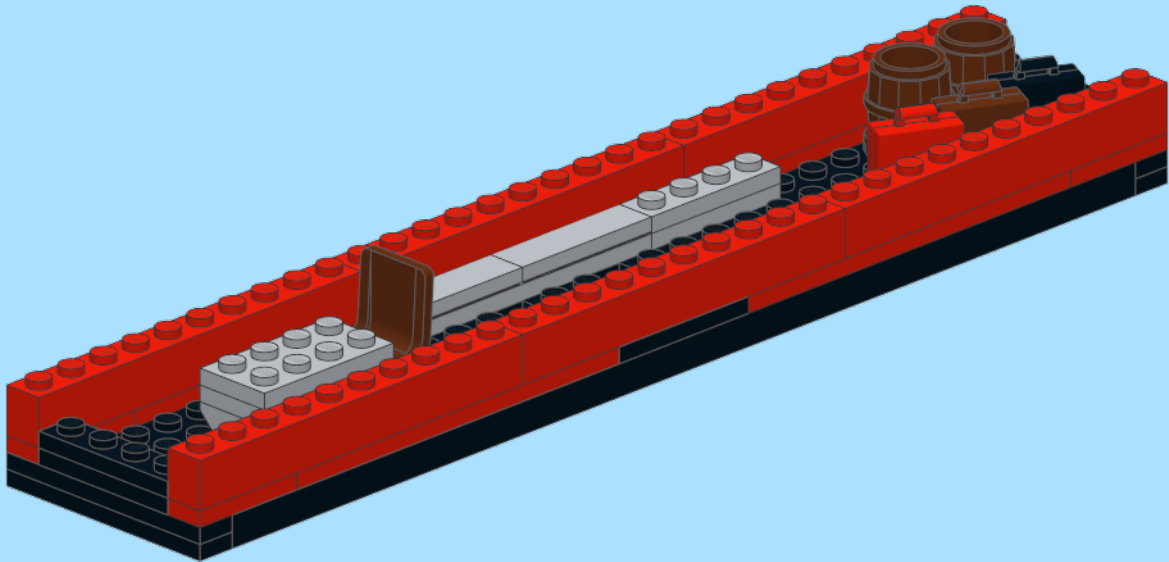
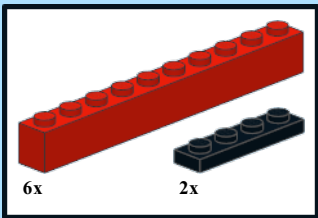

6

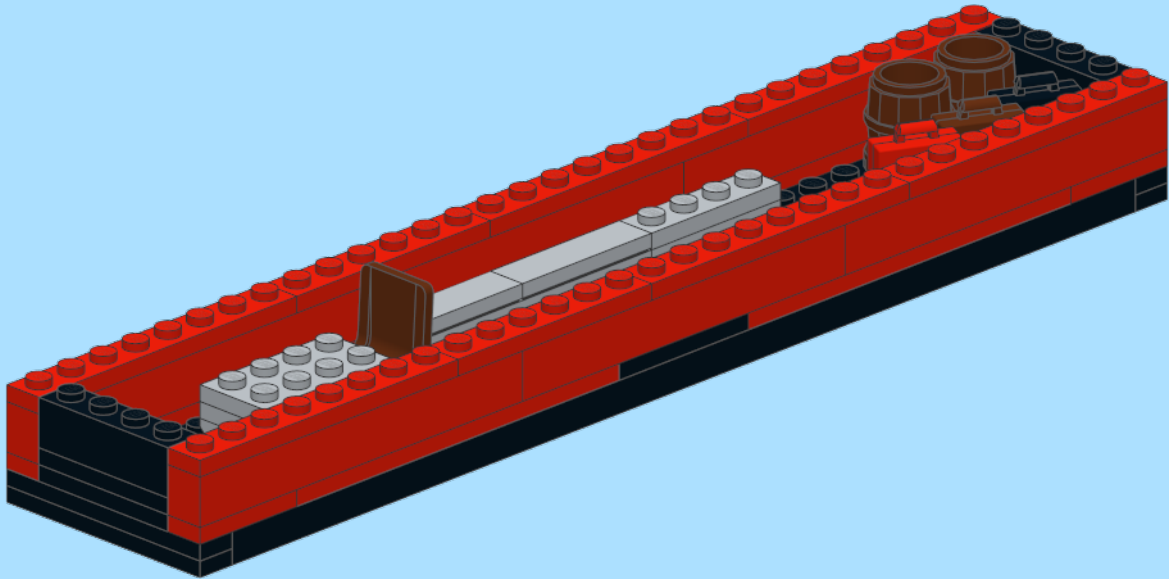
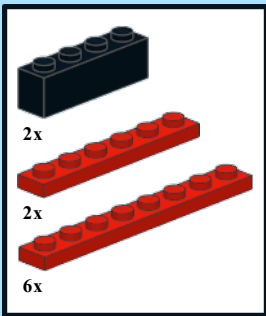

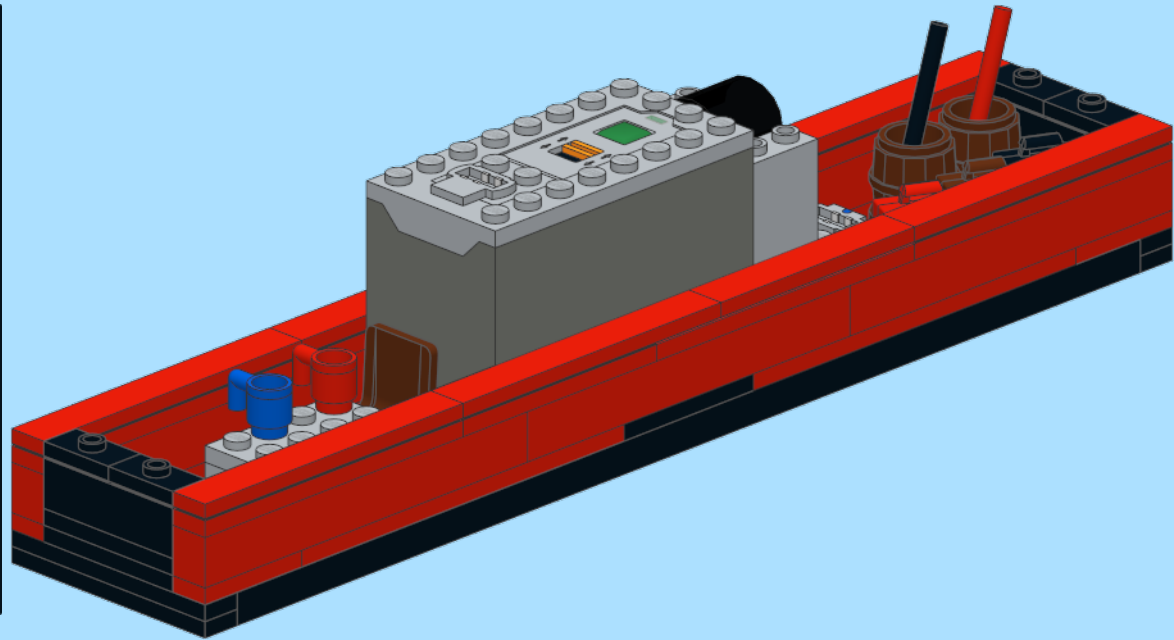
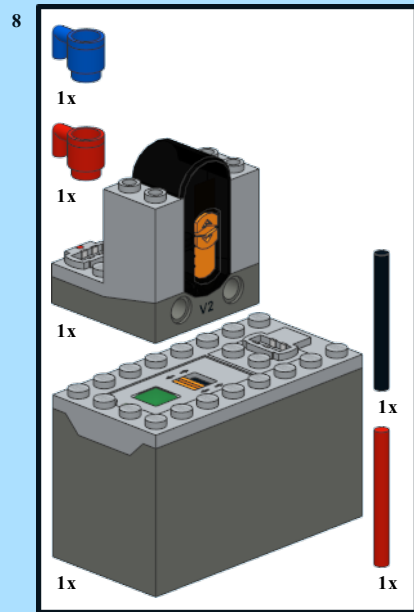
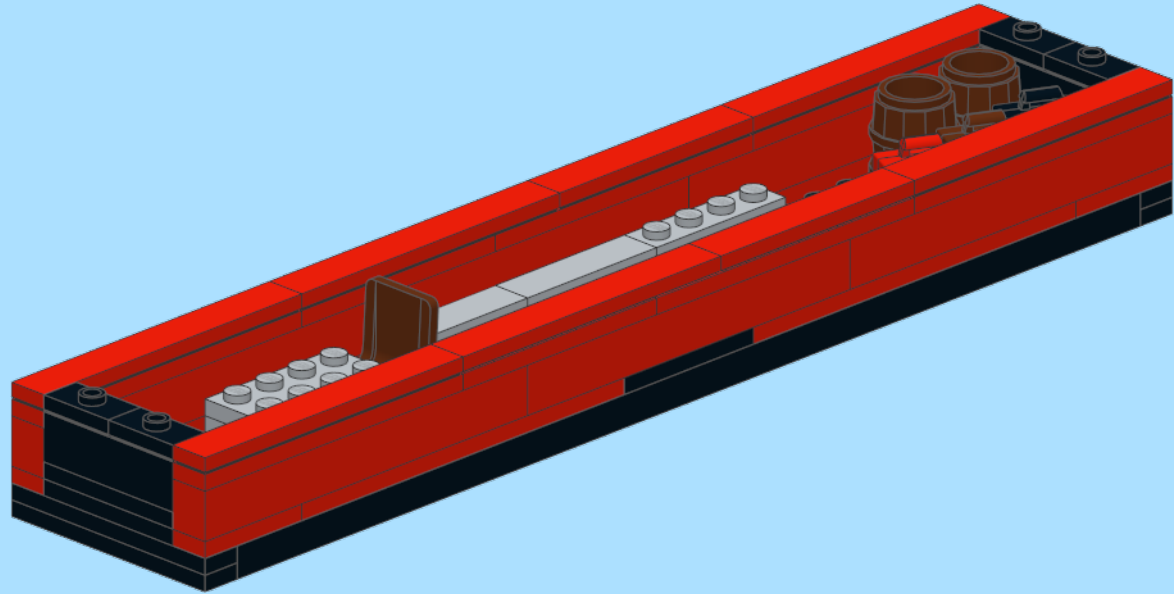
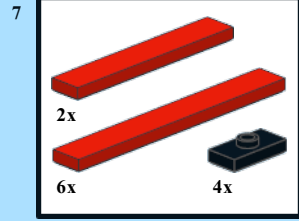

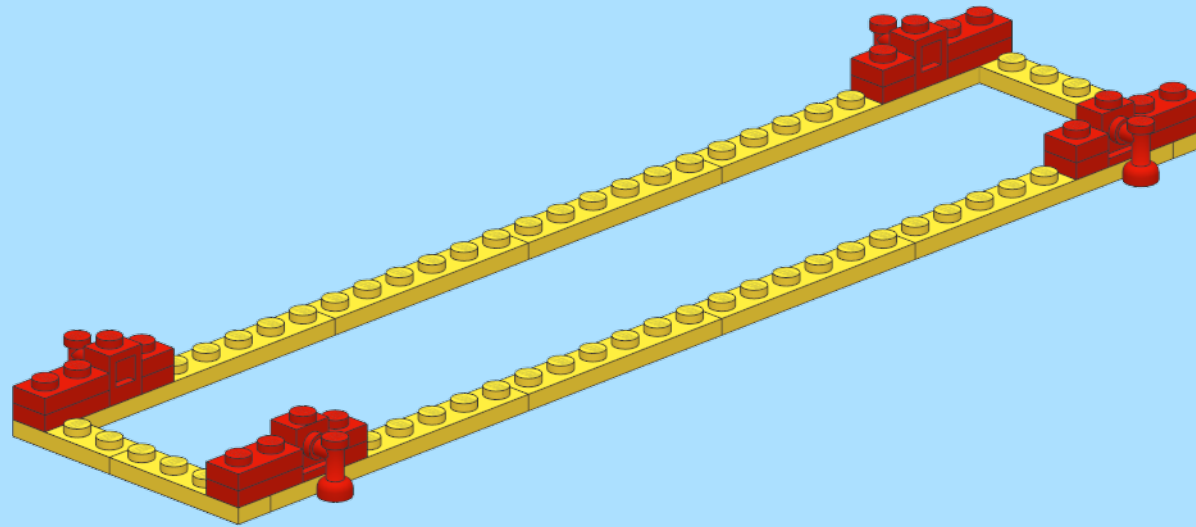
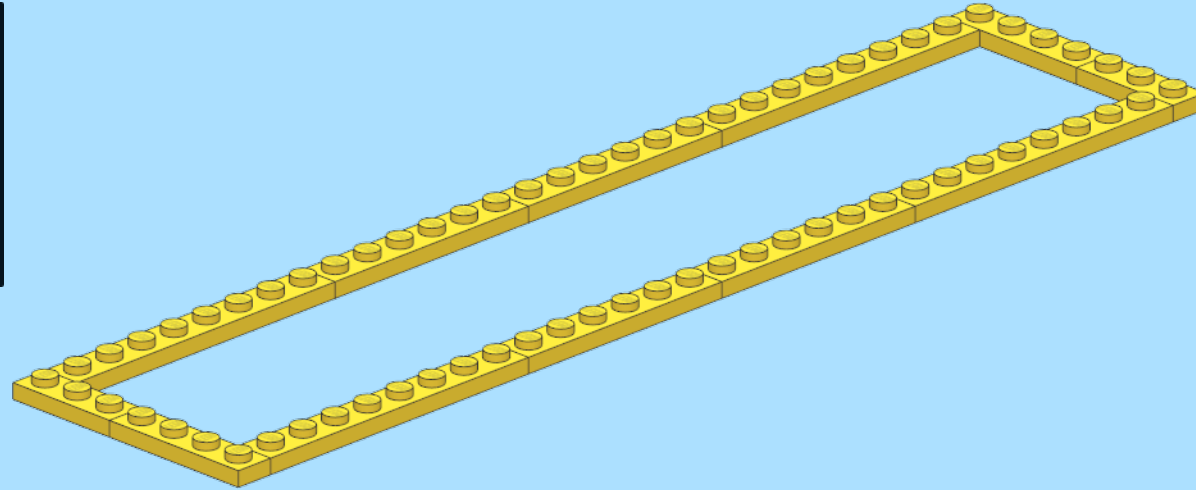
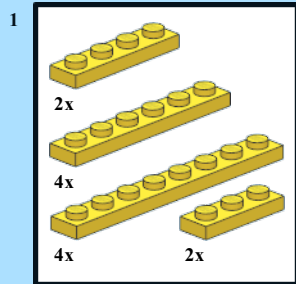

3

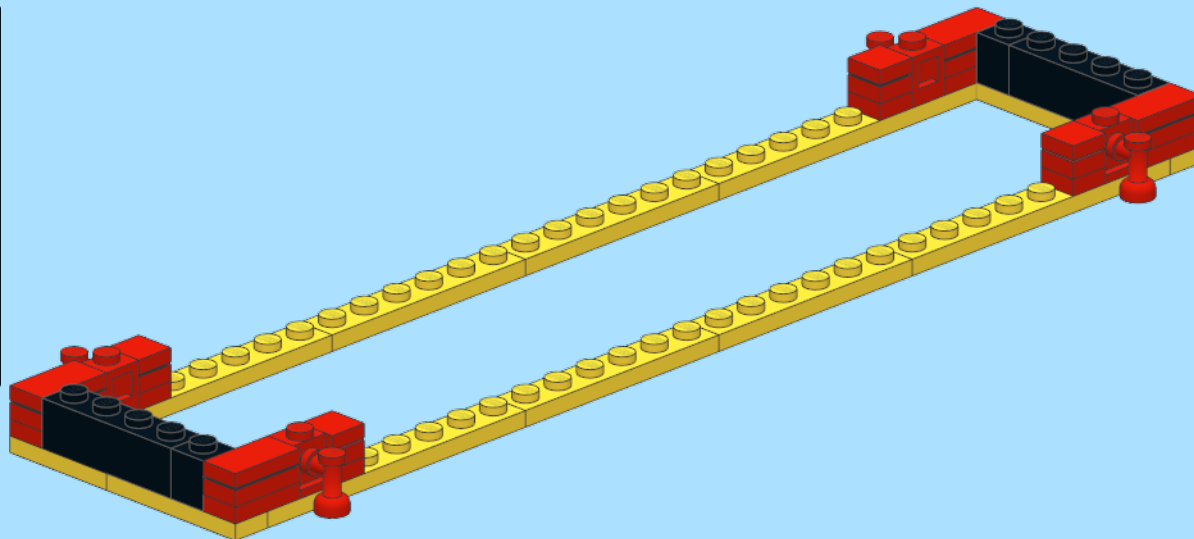
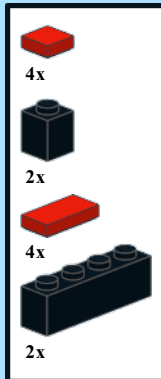

4

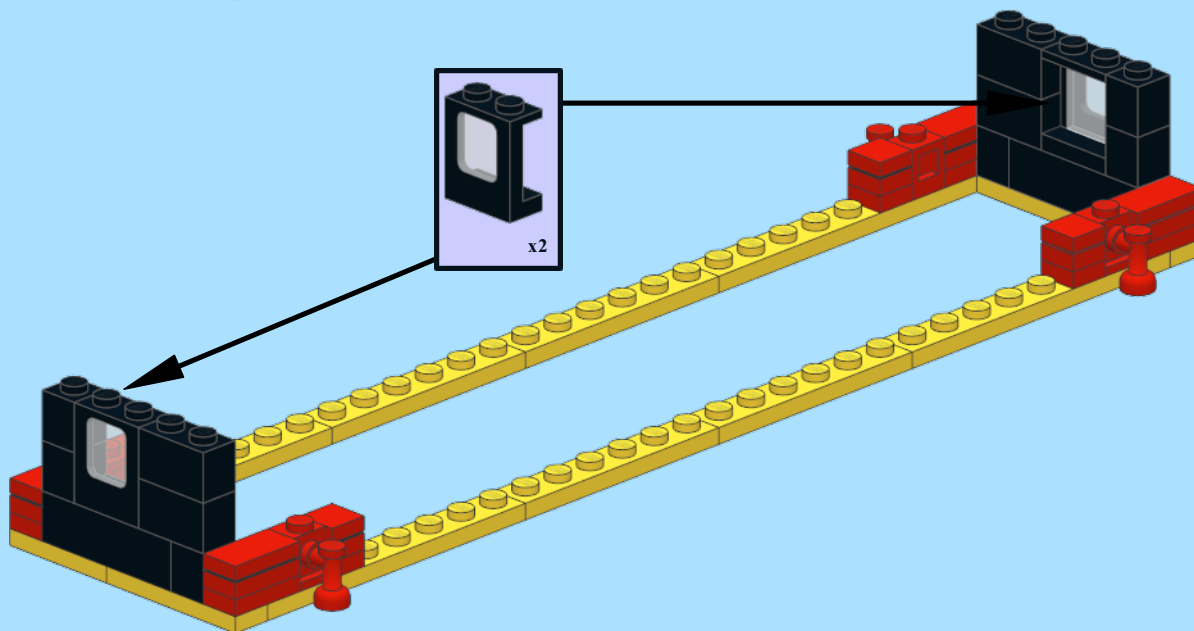
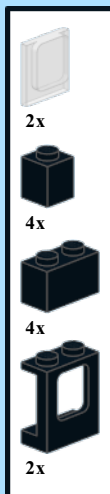

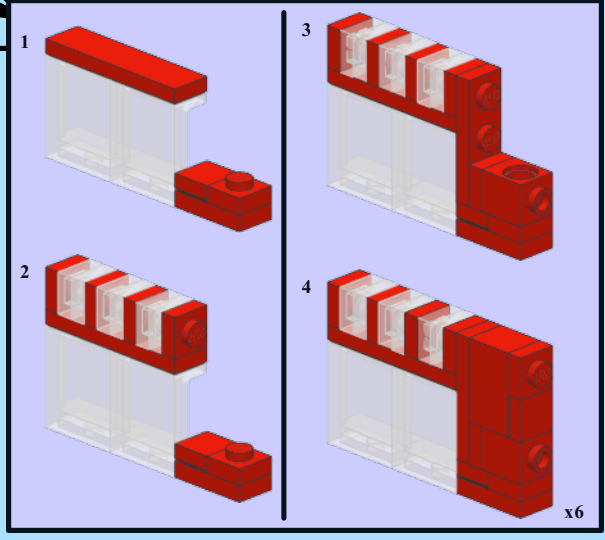
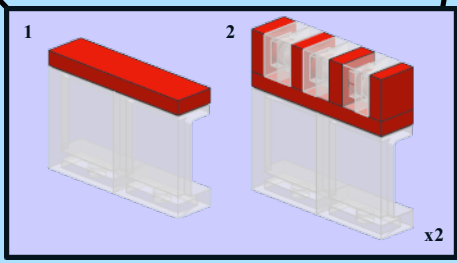
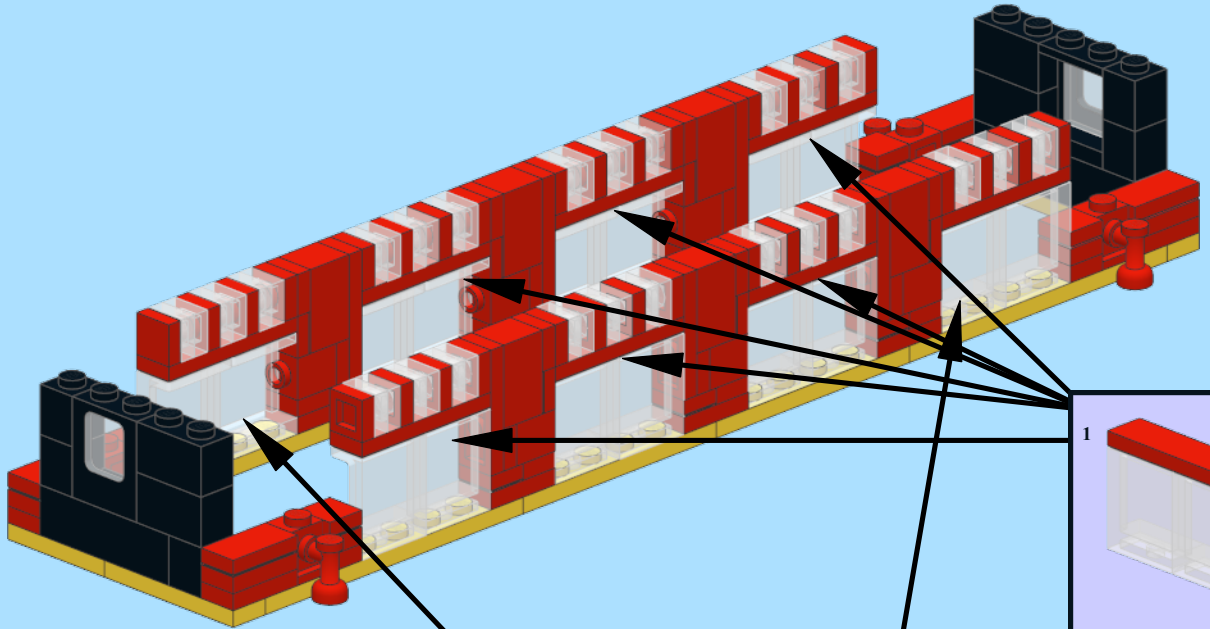
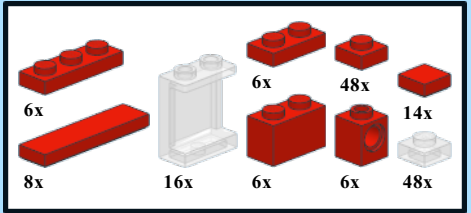

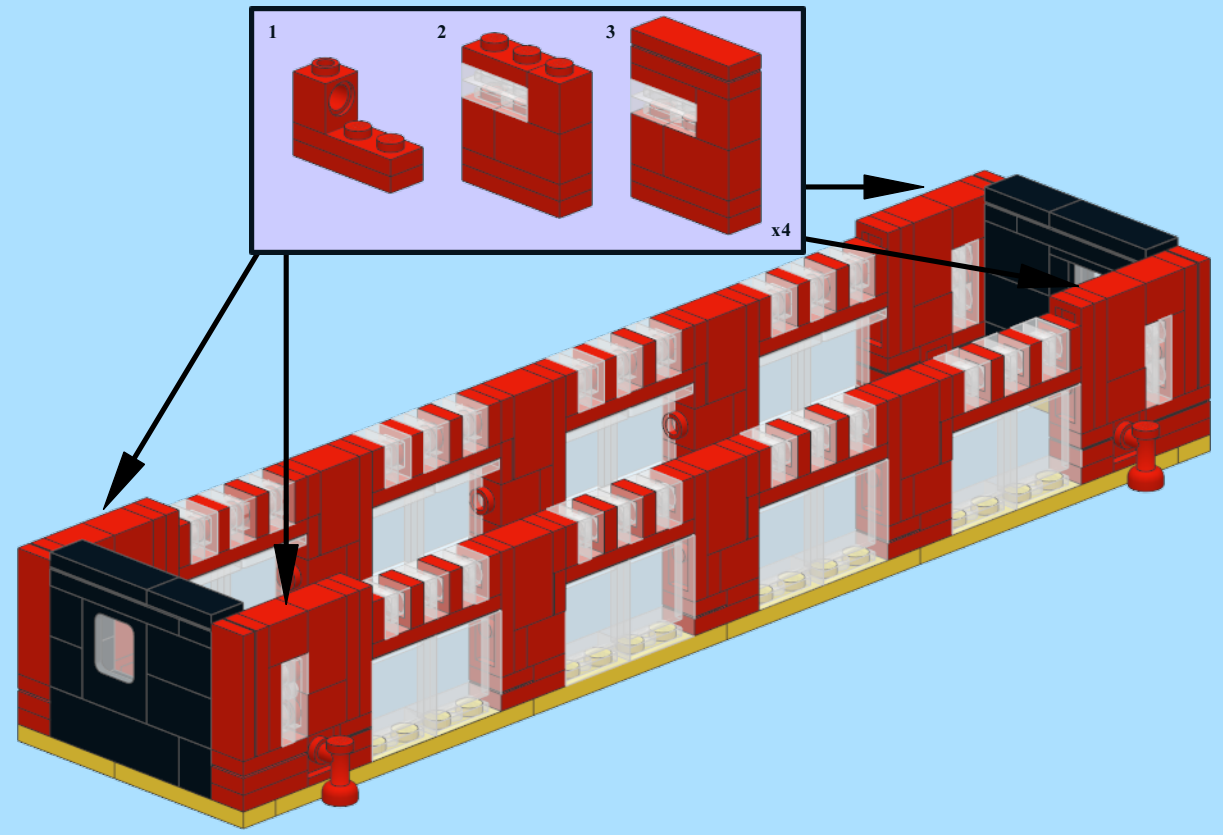
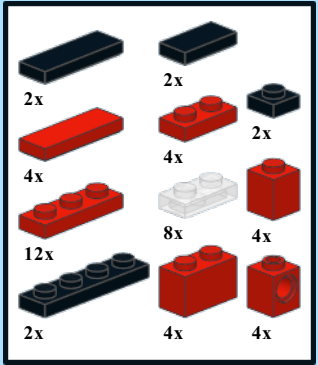

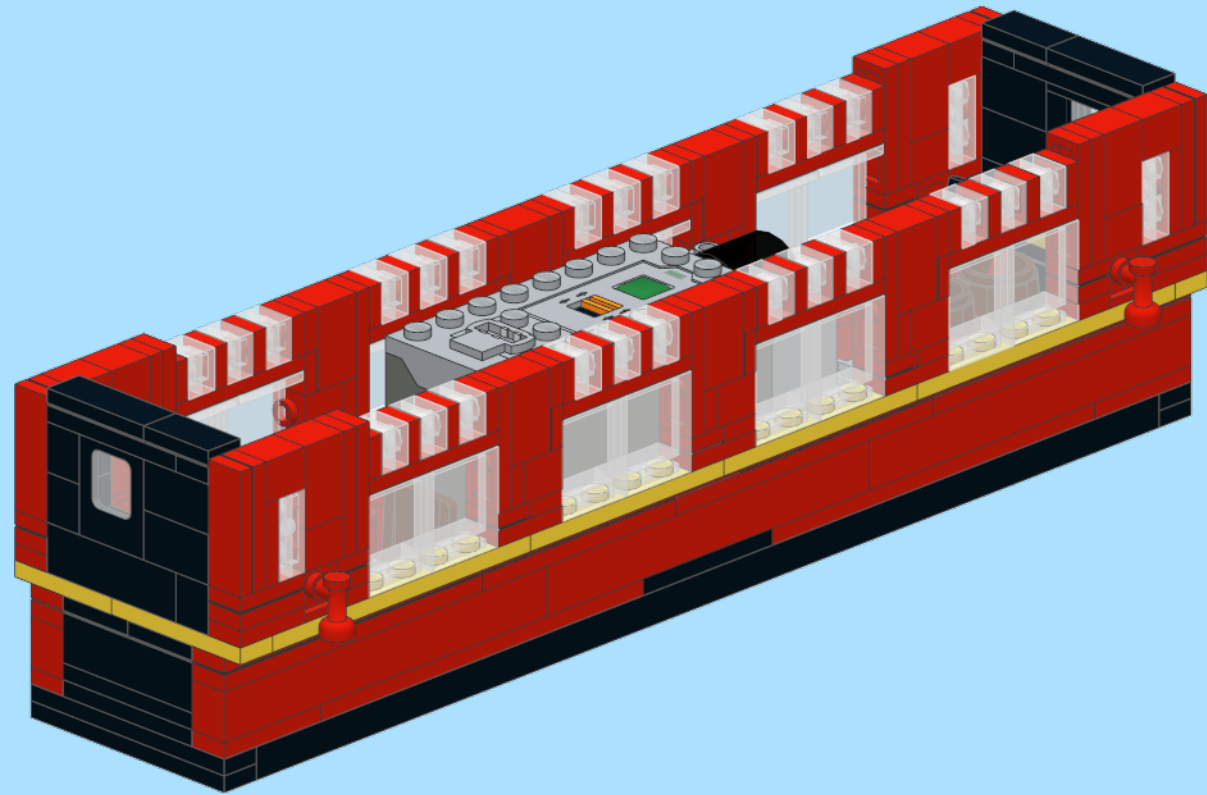

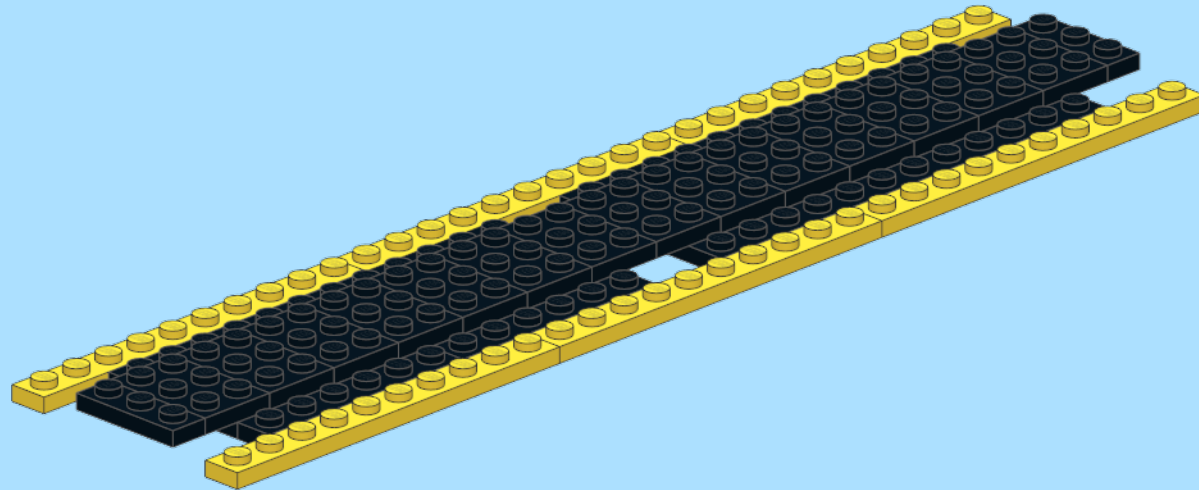
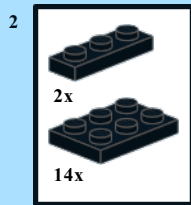
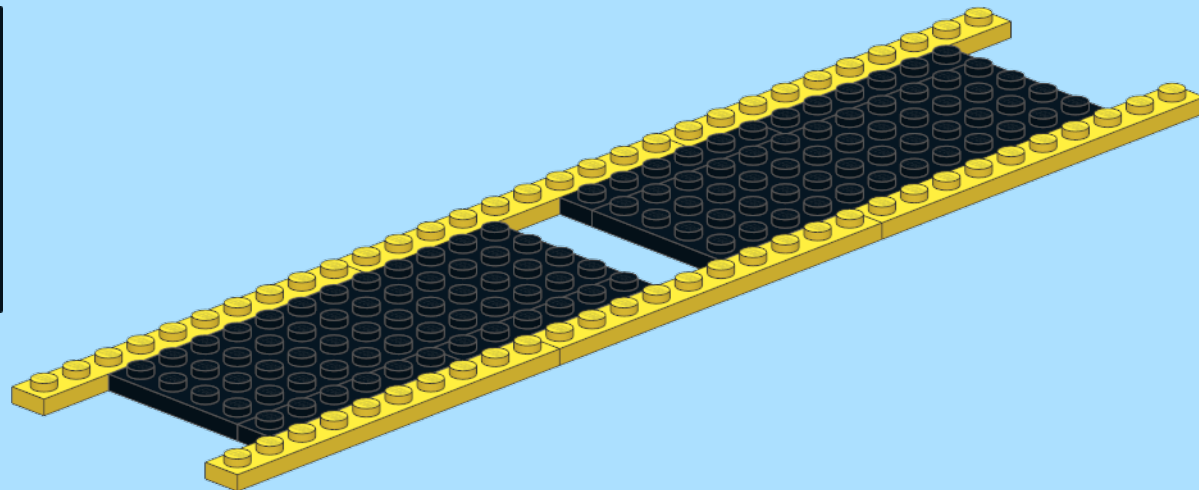
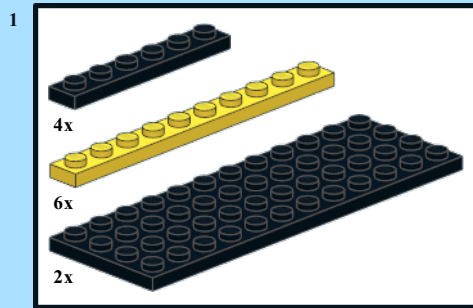

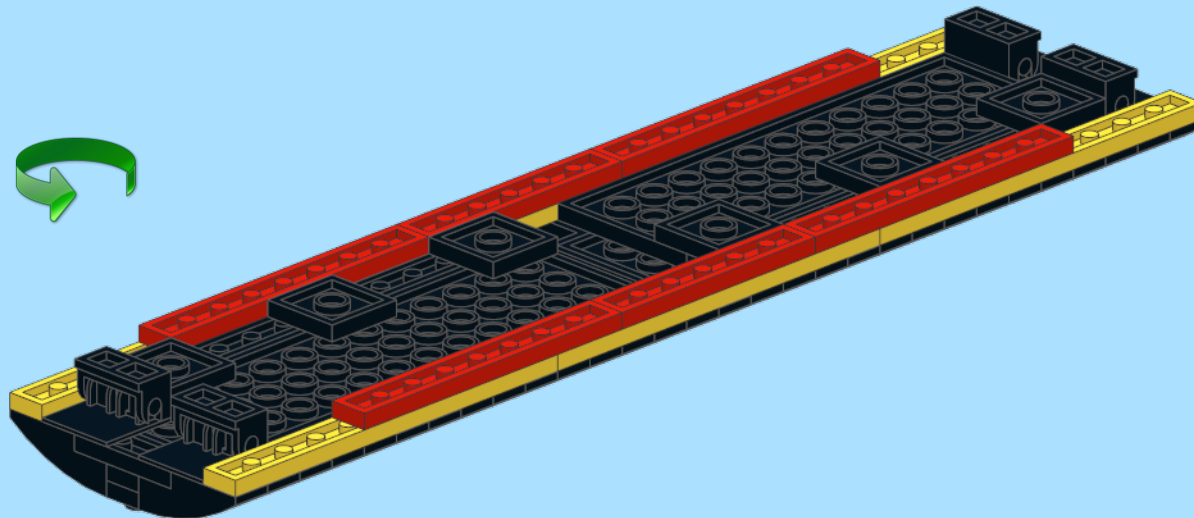
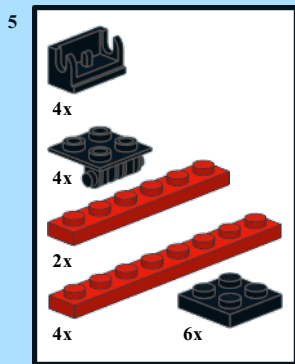
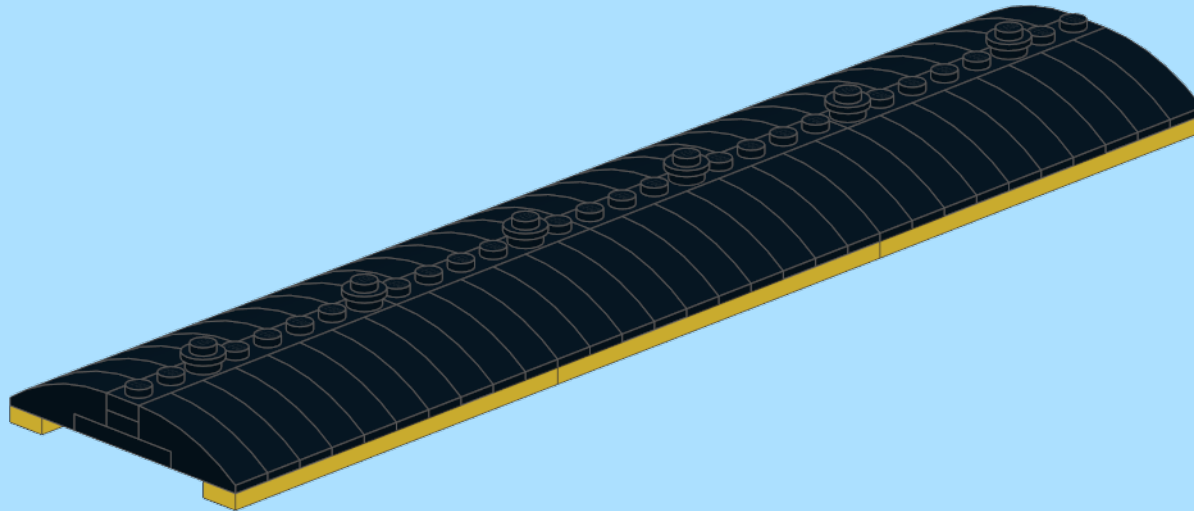
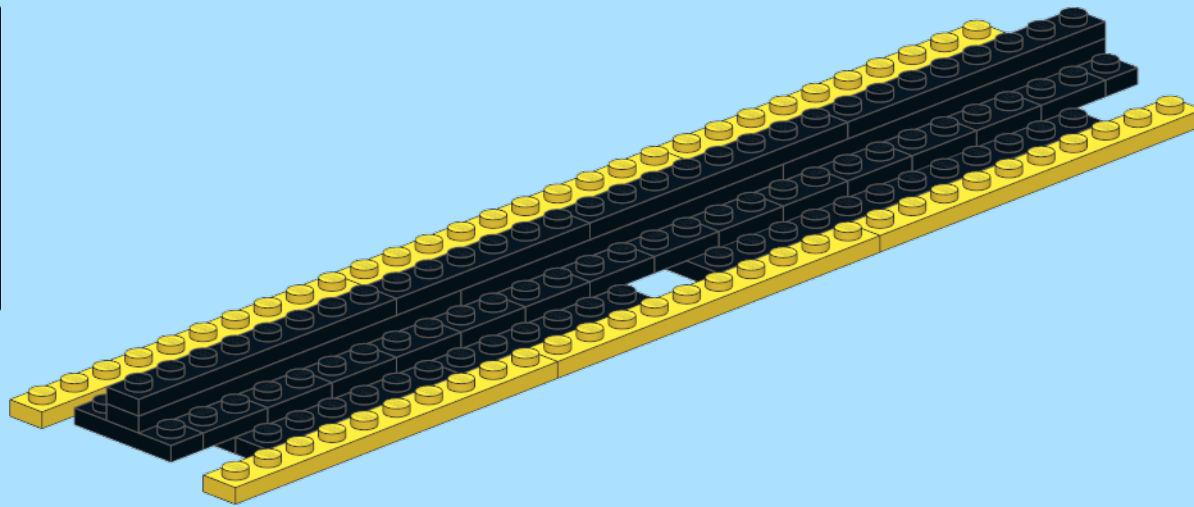
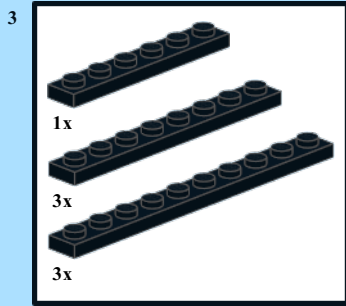

x2

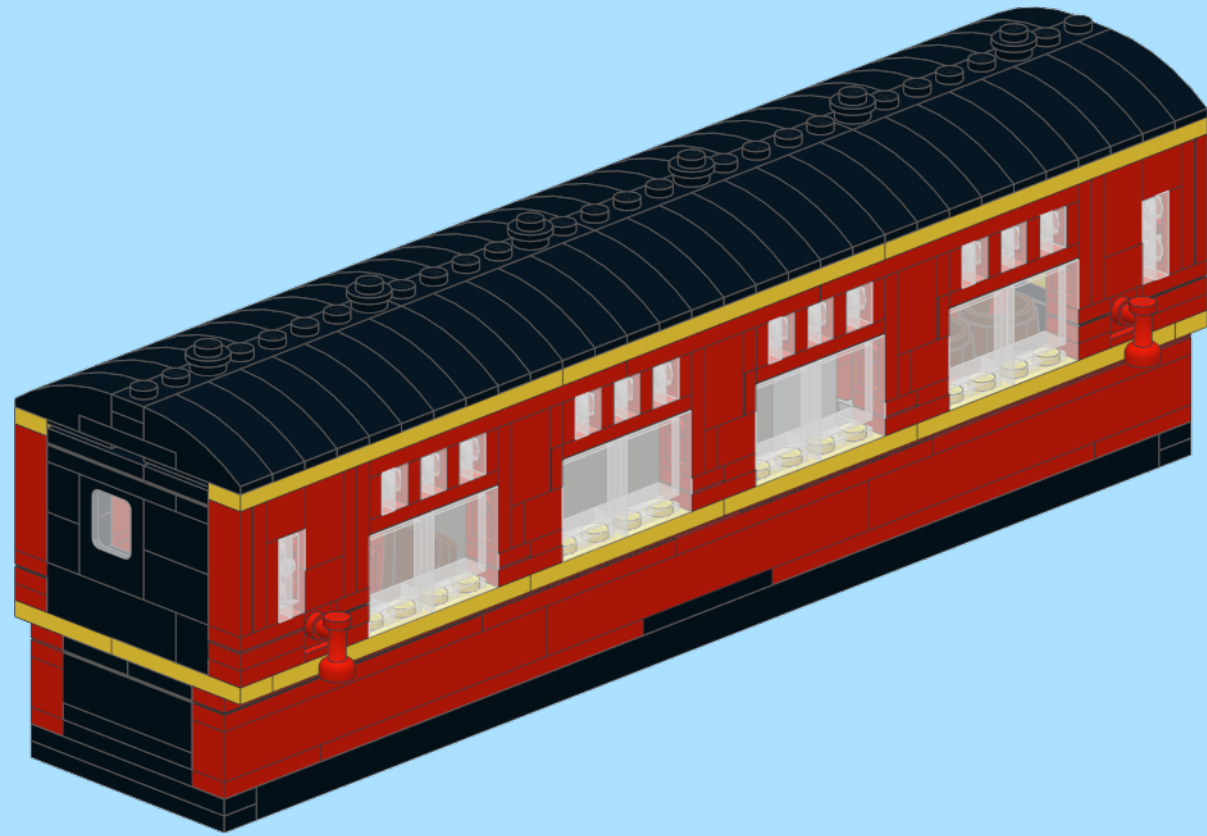

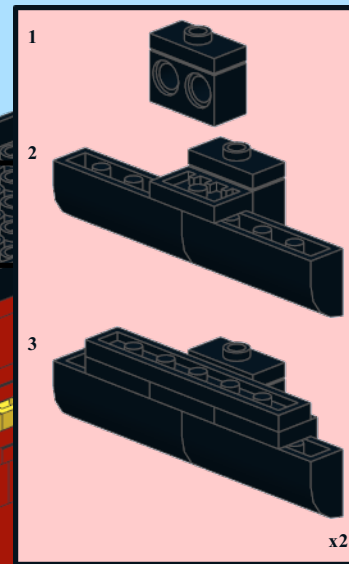
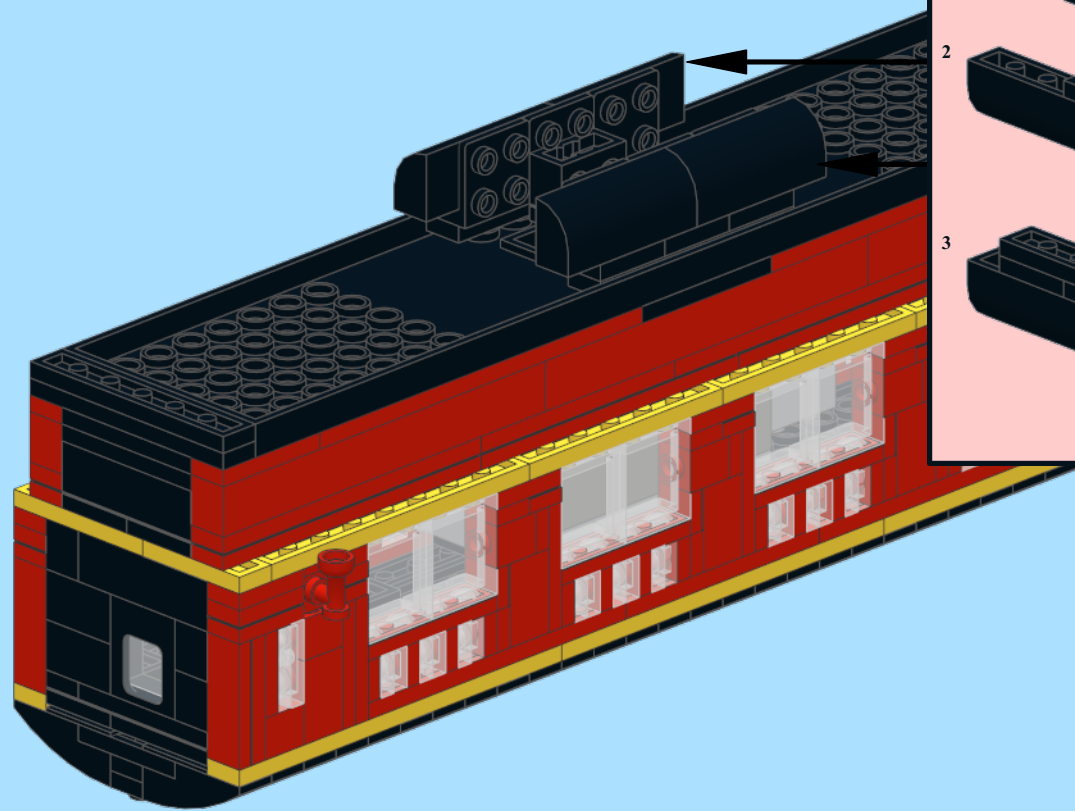
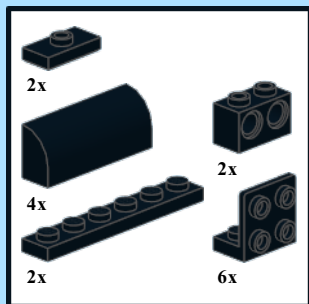

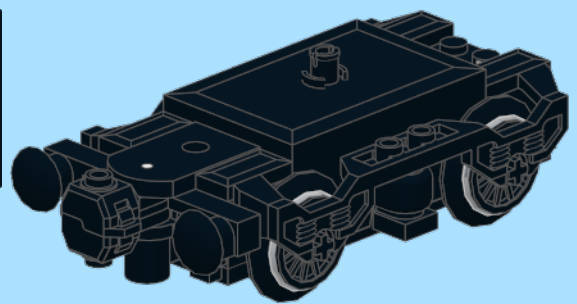
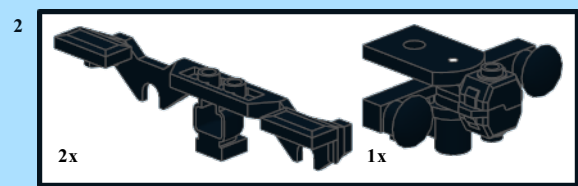
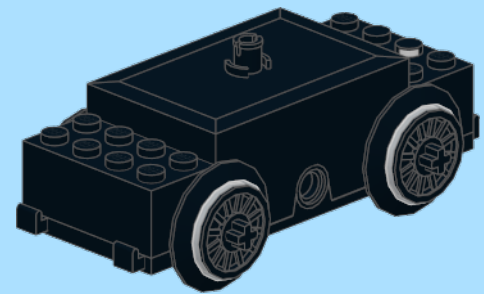

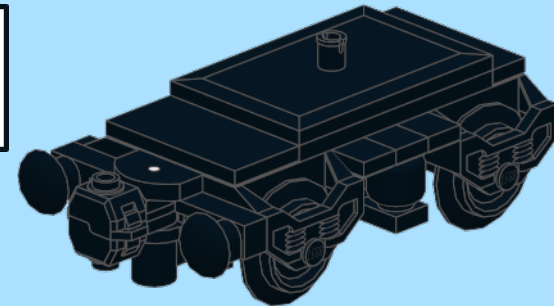
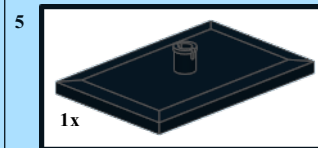
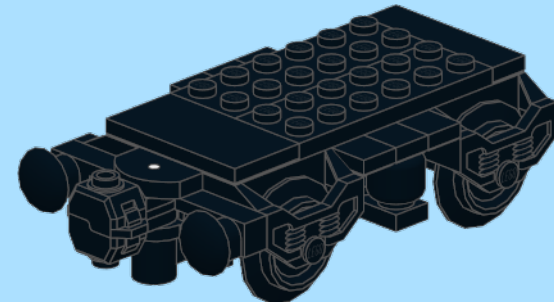
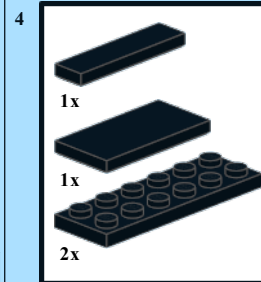
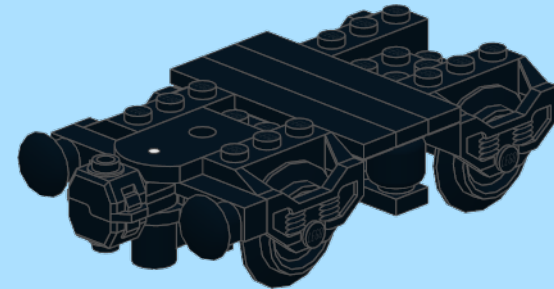
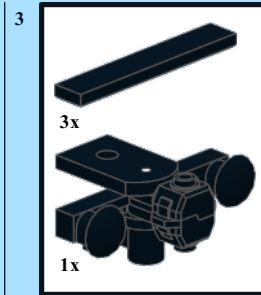
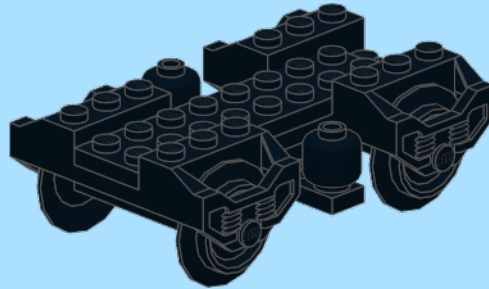
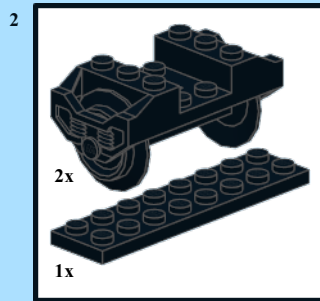
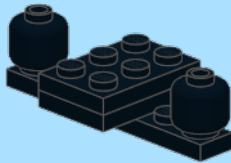
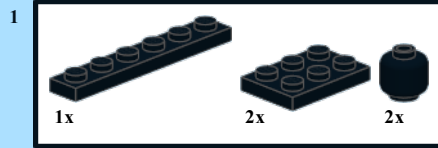

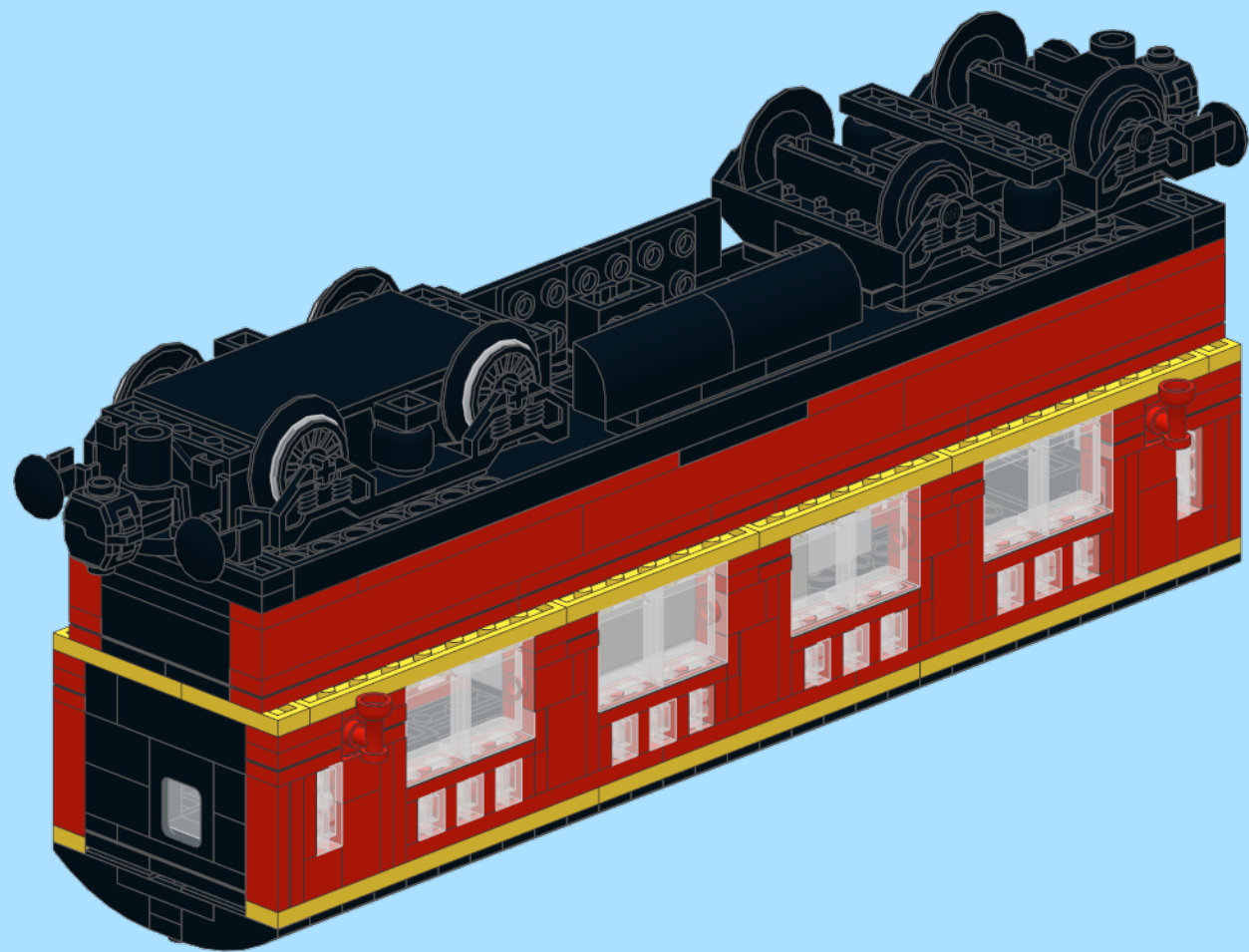



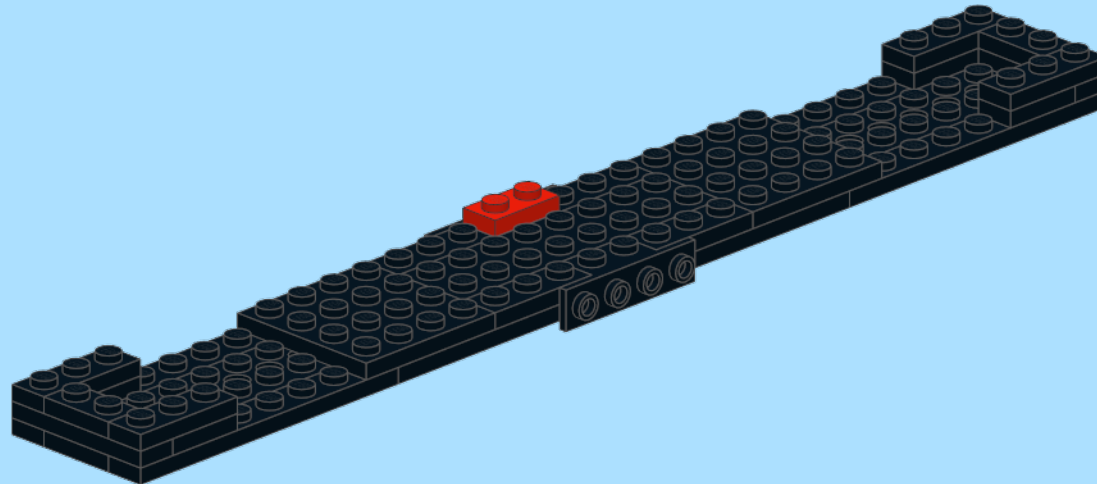
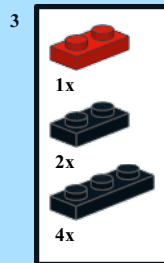
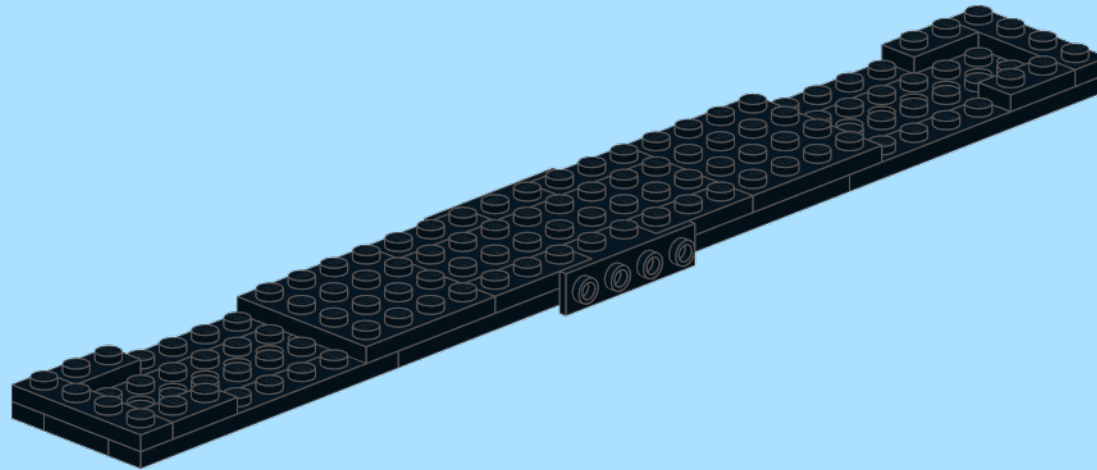
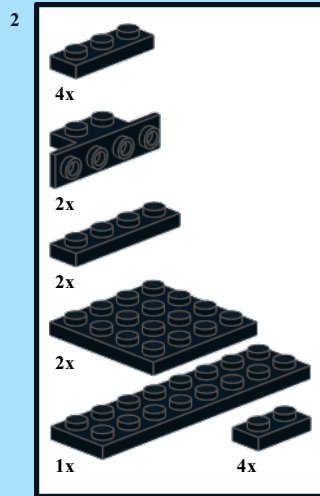
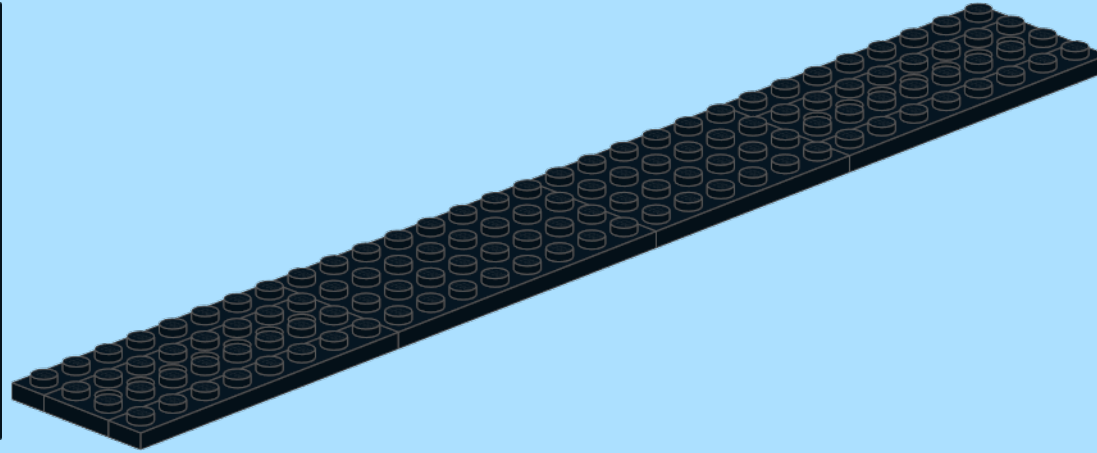
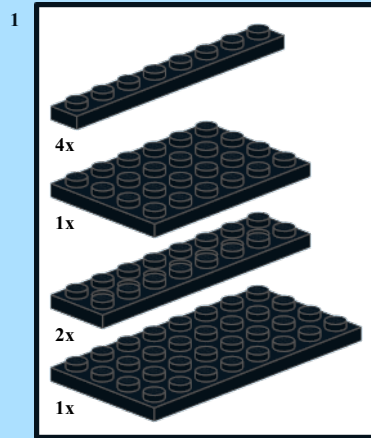

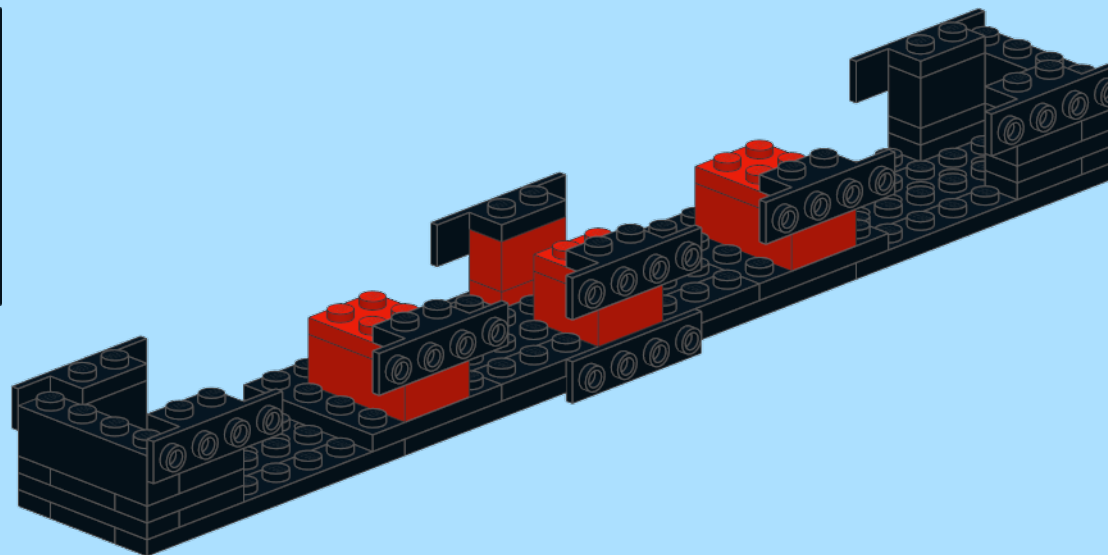
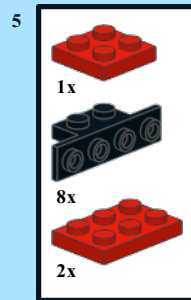
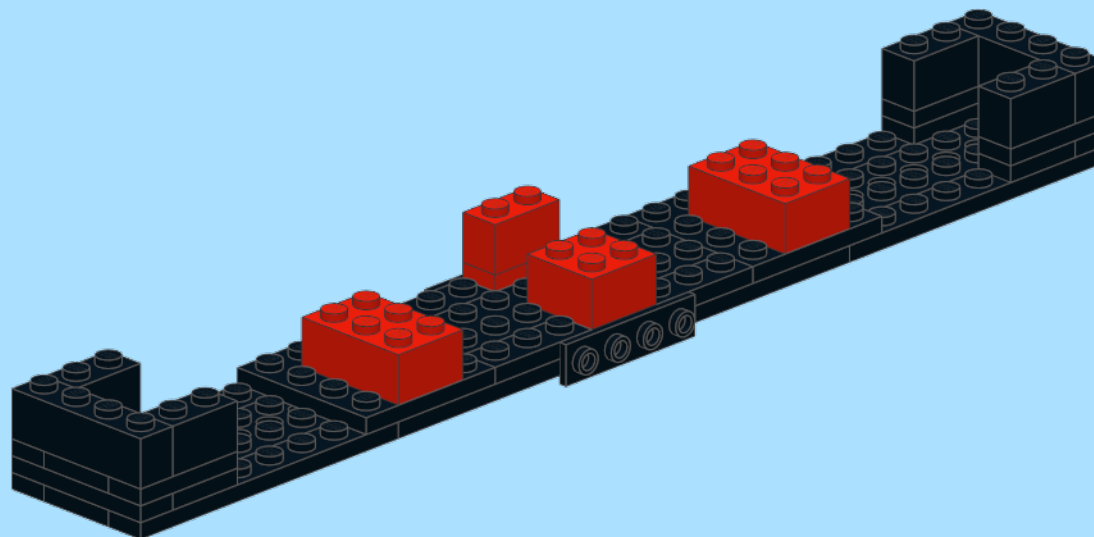
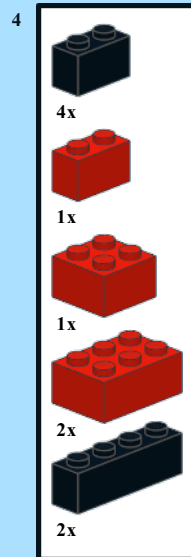

6

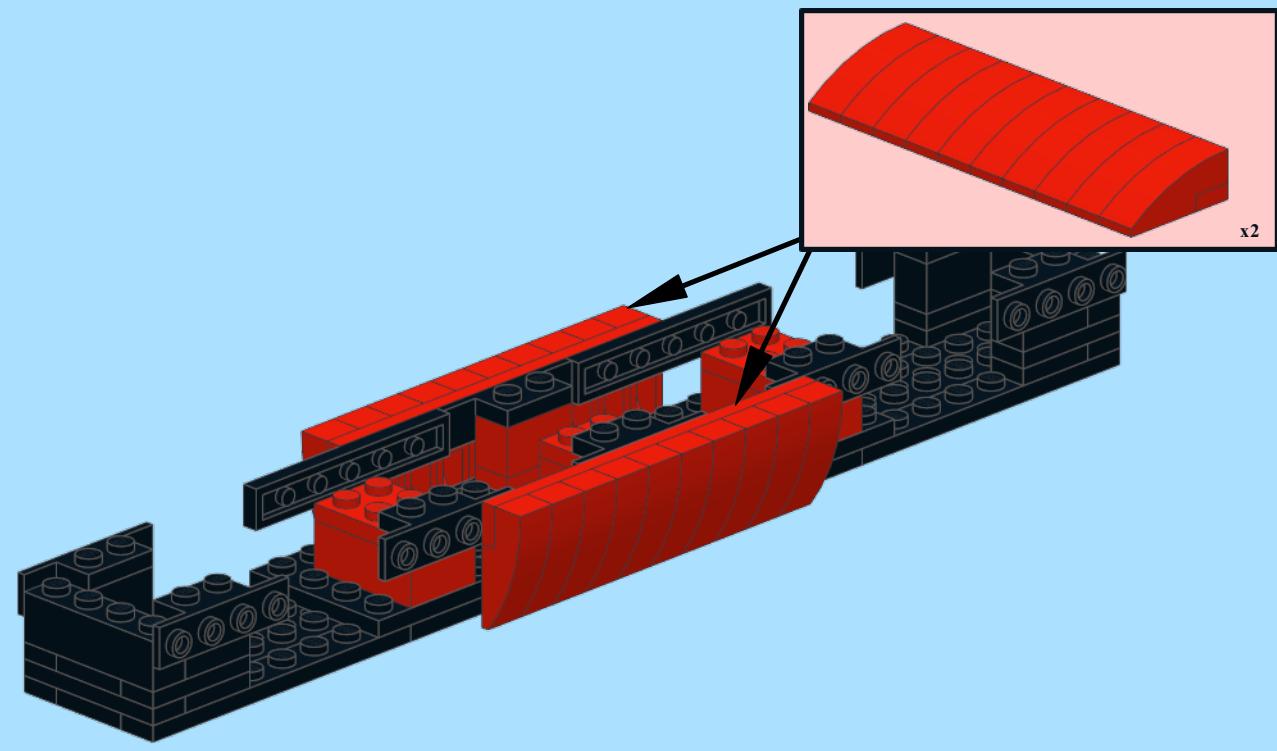
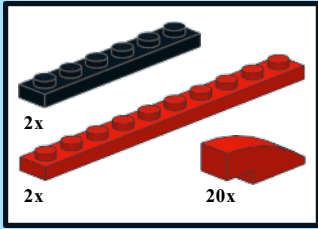

1

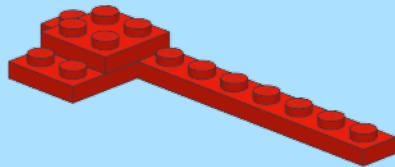
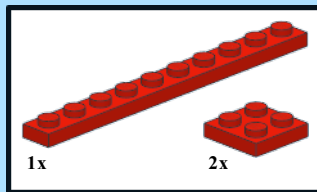

2

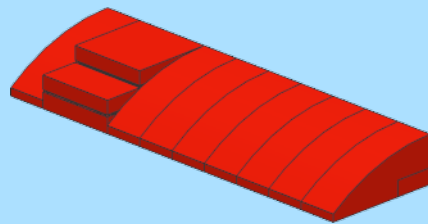
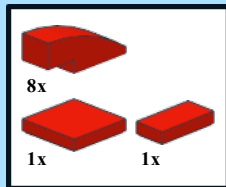

x2

1

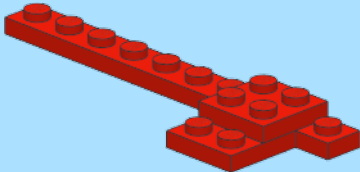
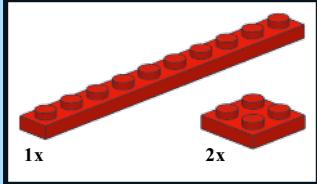

2

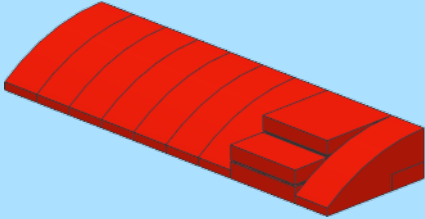
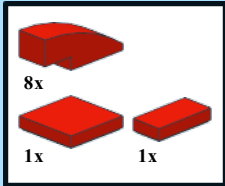

x2

7

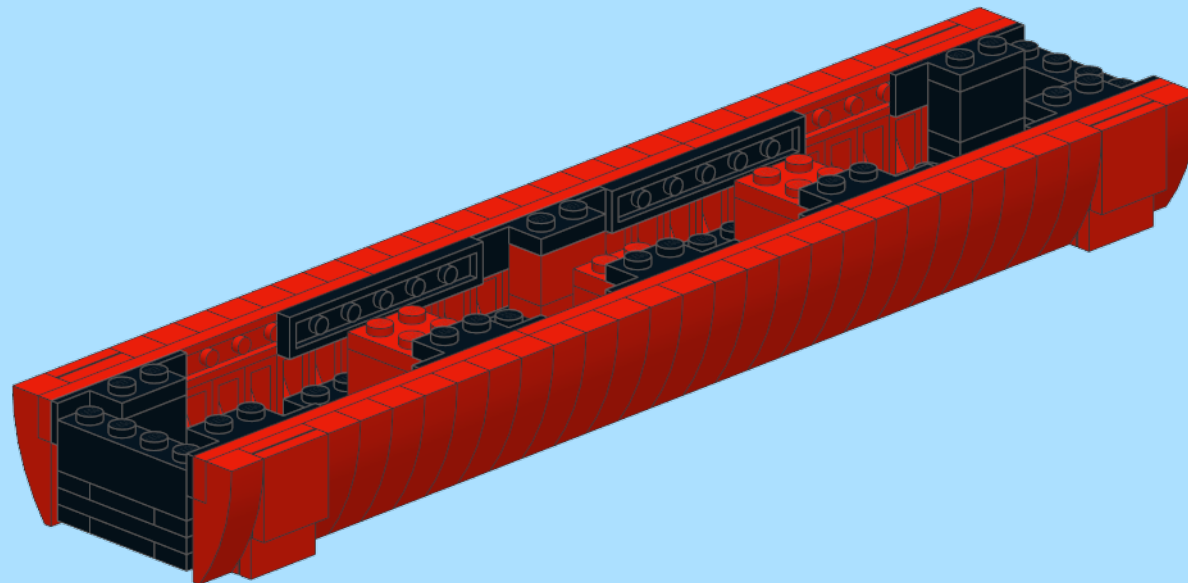

8

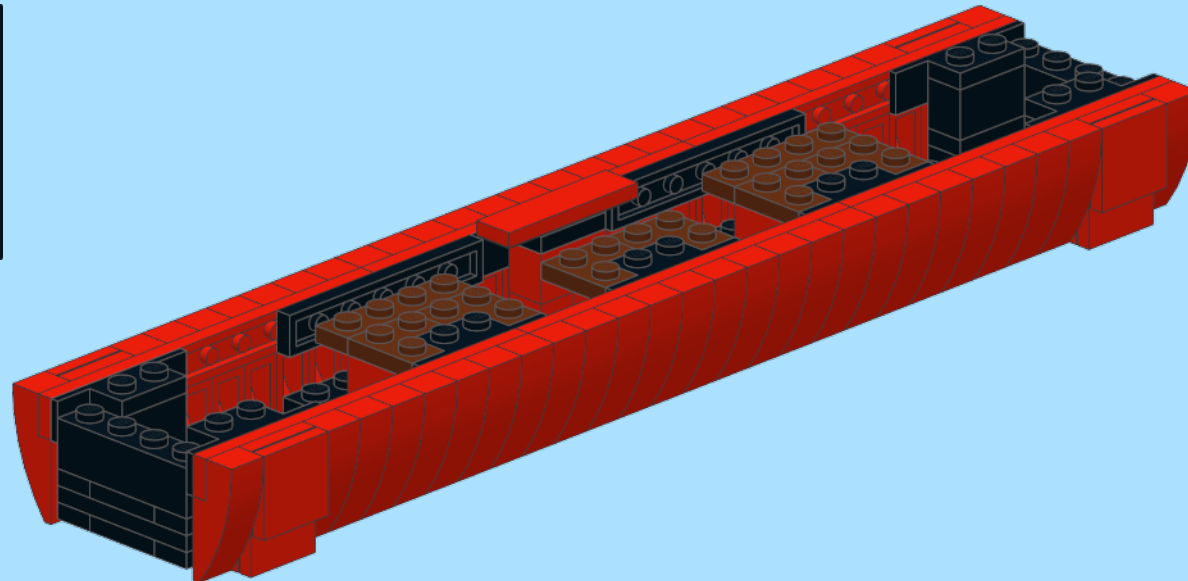
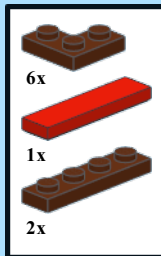

9

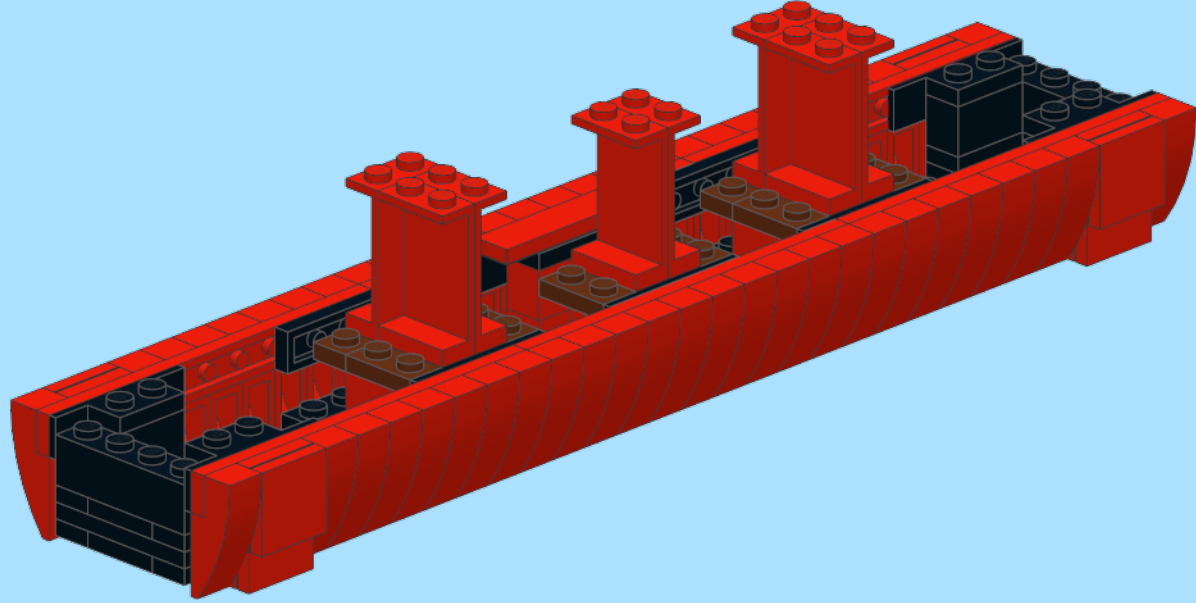
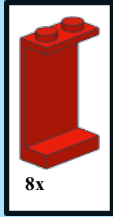

10

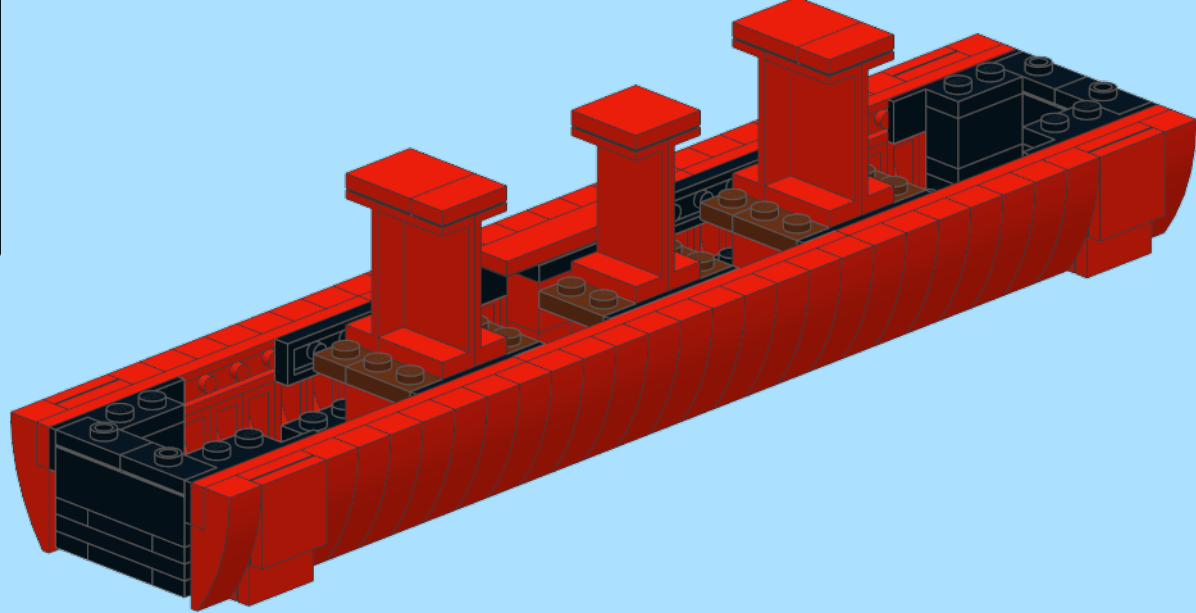
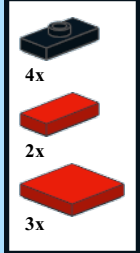

11

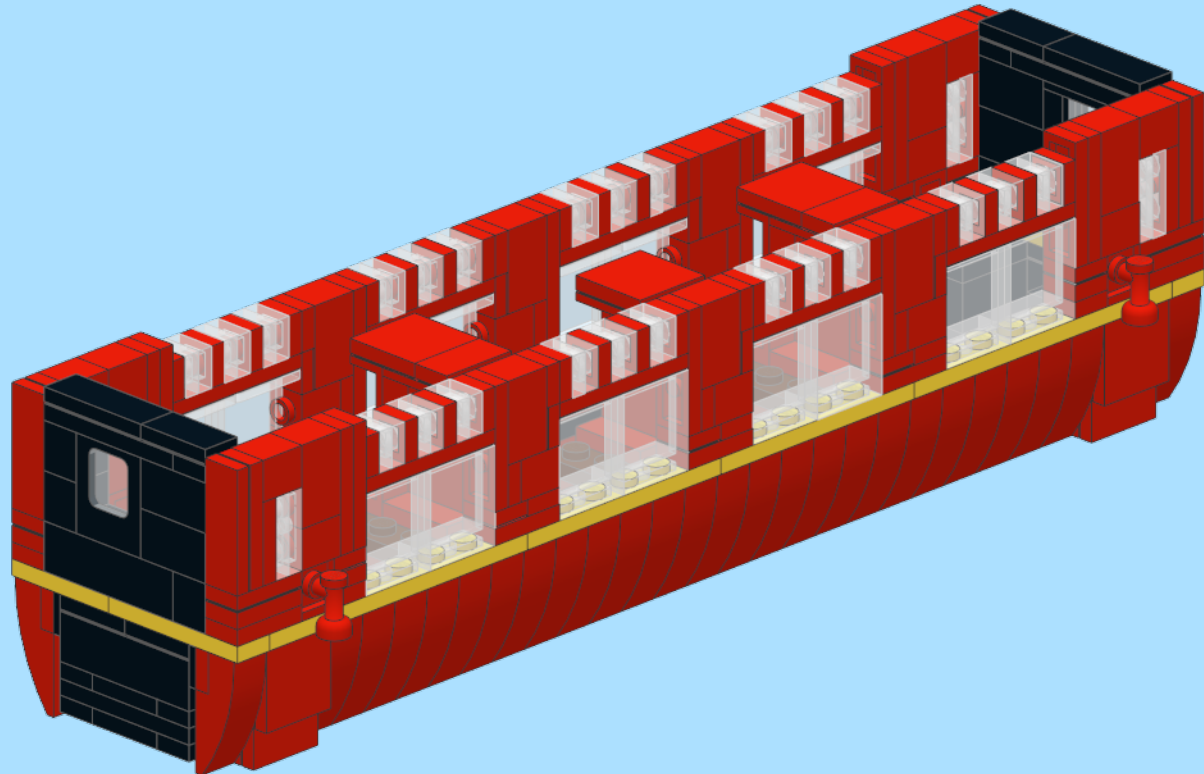

12

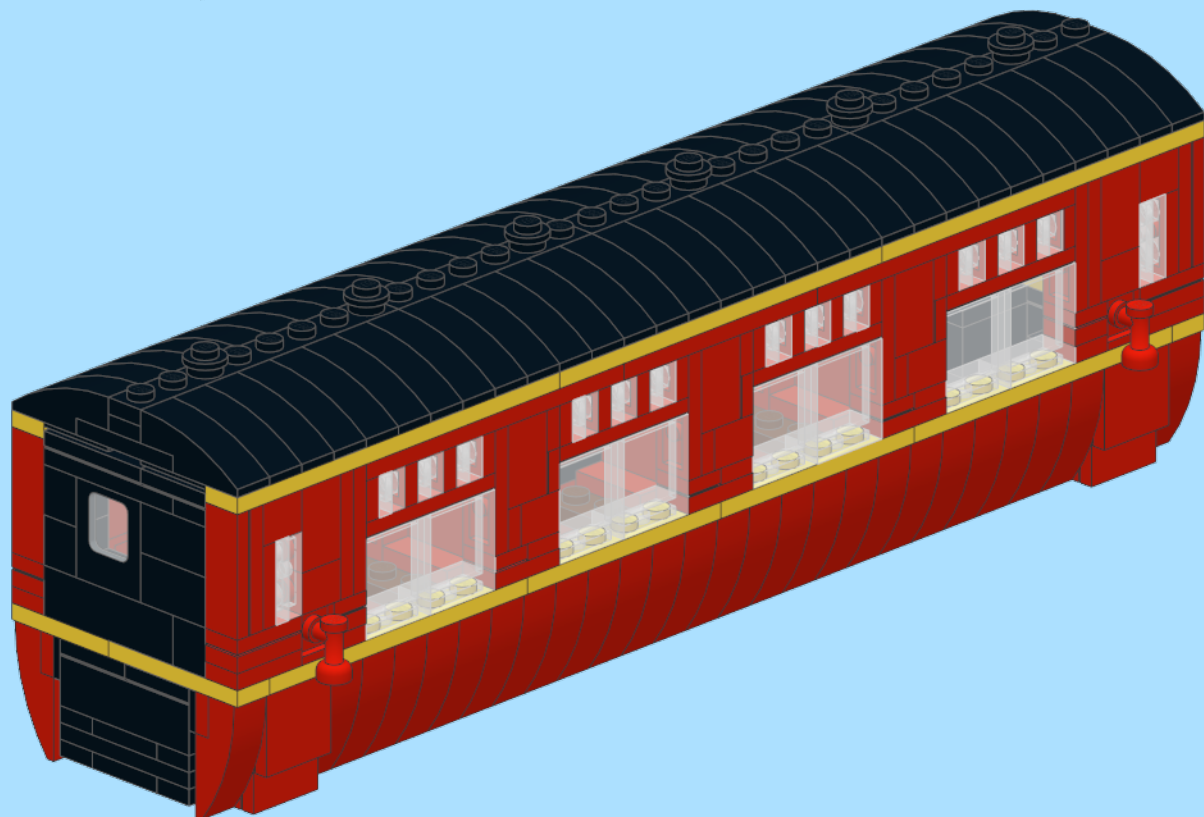

1

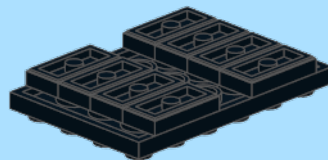
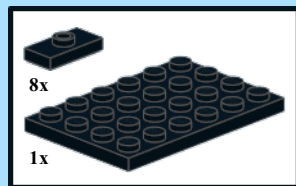

2

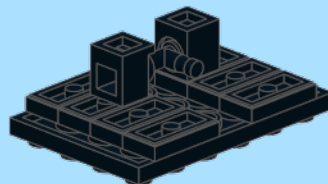
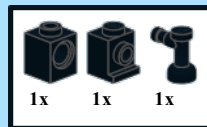

3

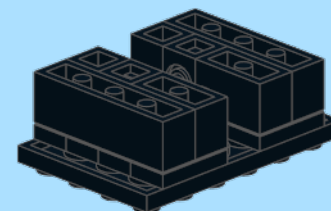
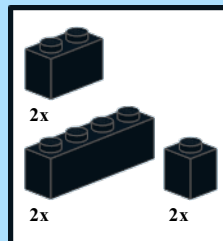

4

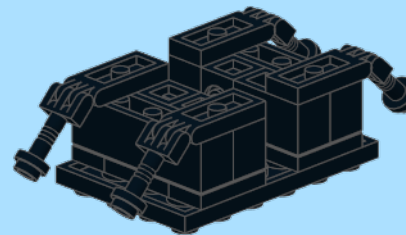
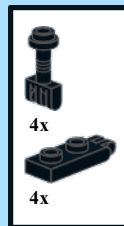

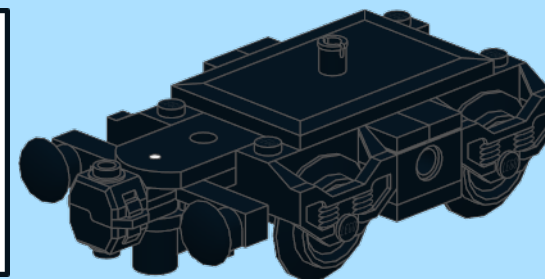
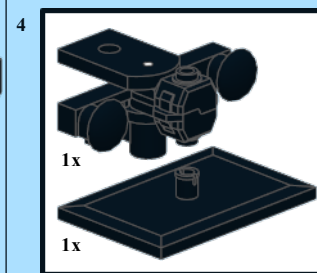
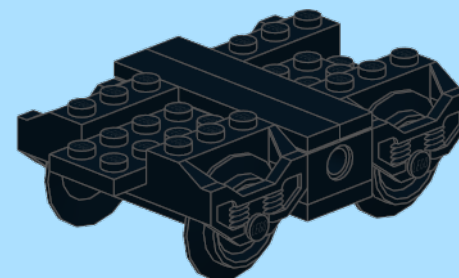
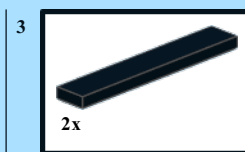
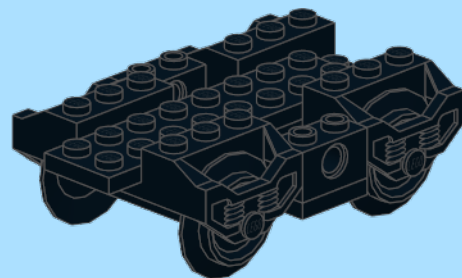
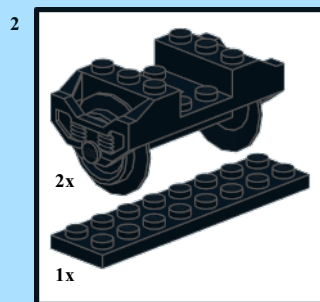
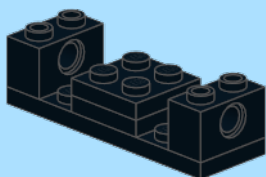
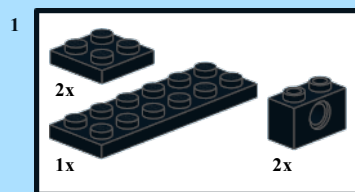

x2

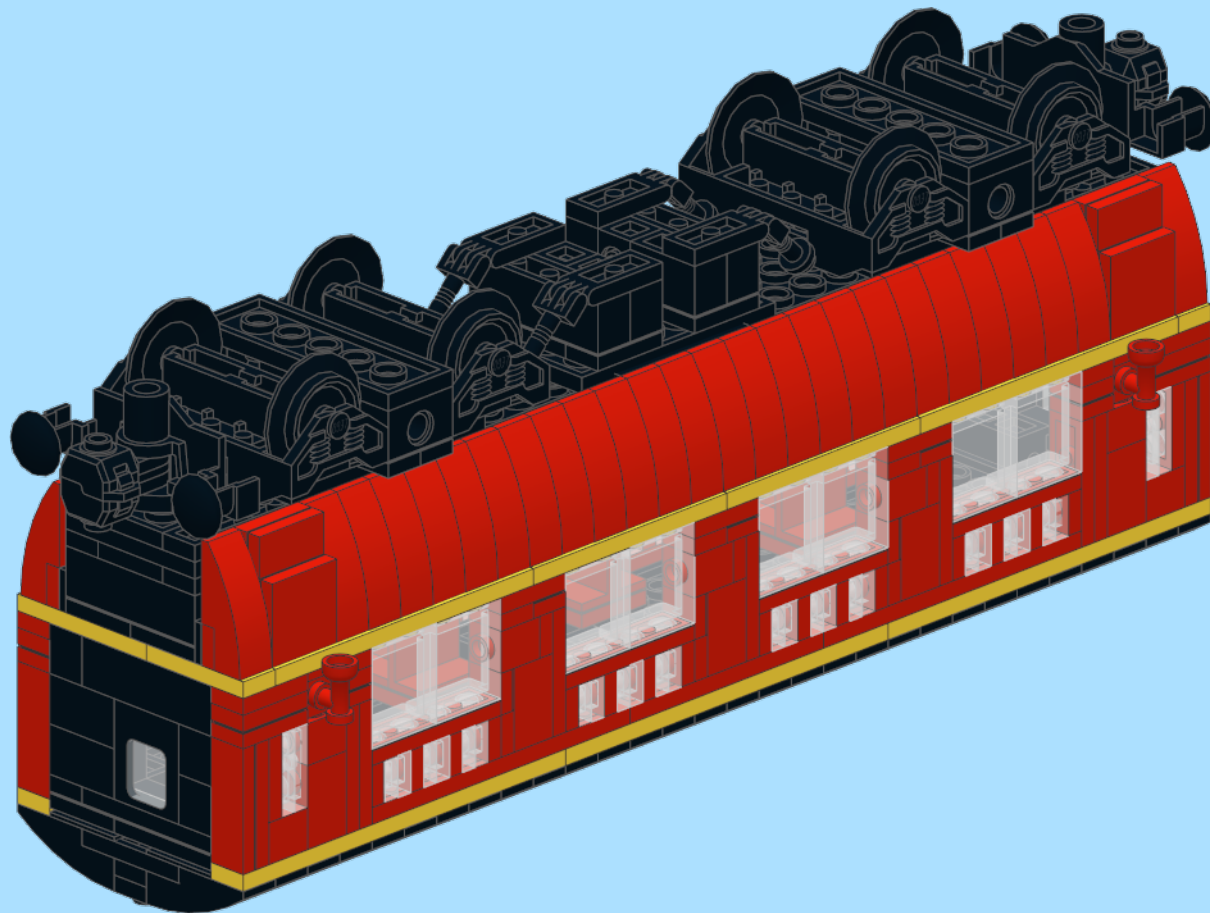

x2



