

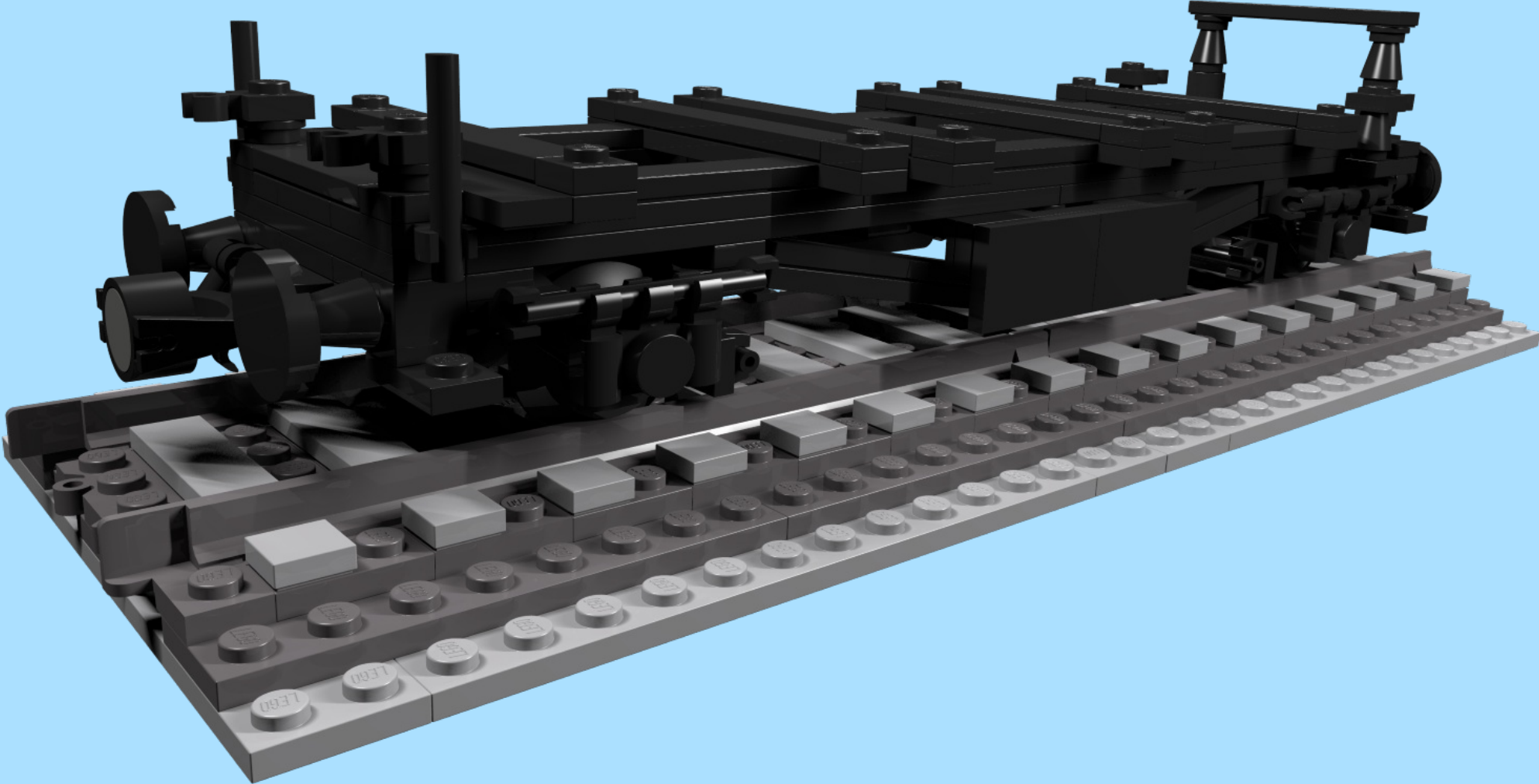

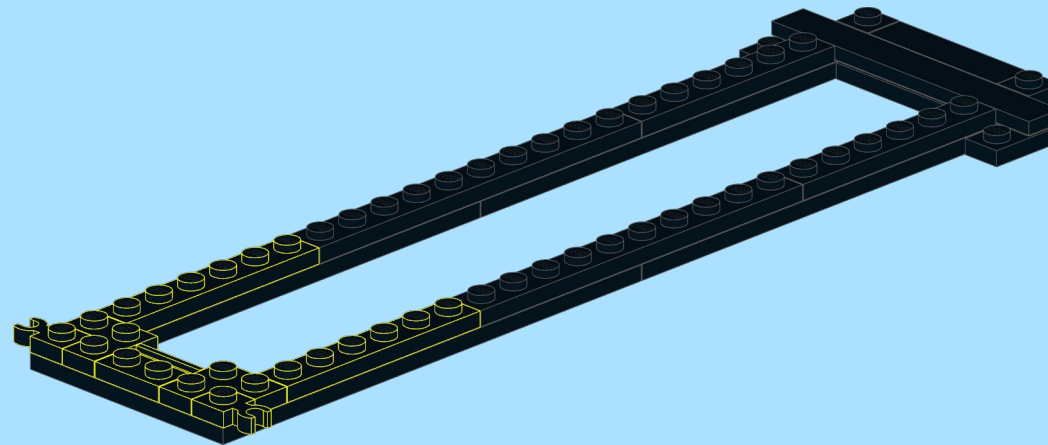

# Behaeltertragwagen BTs30

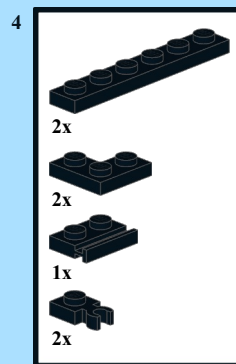
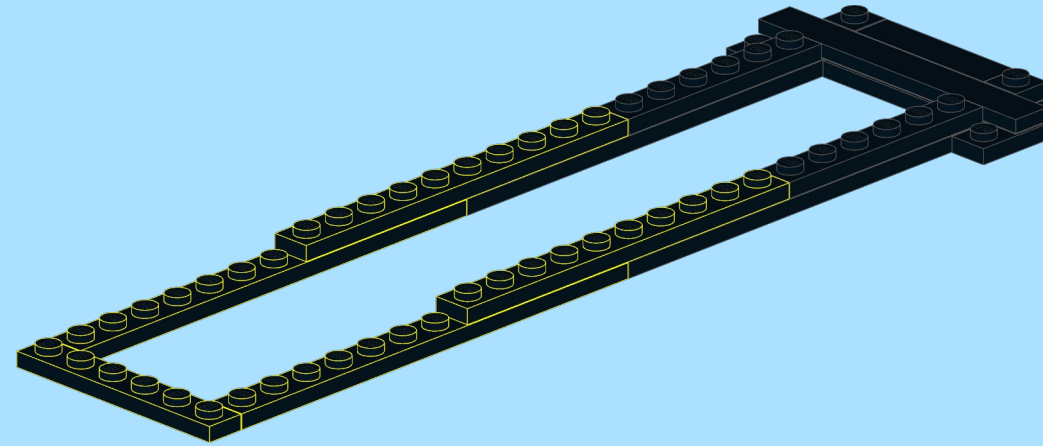
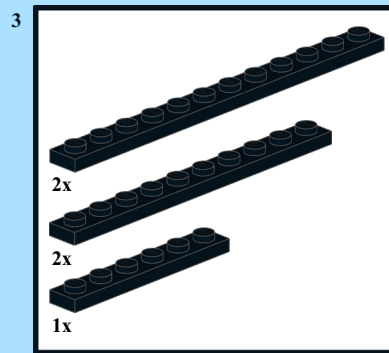
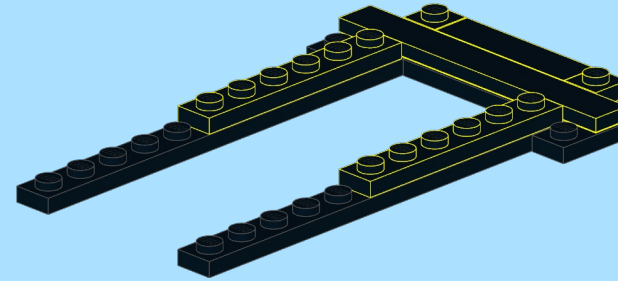
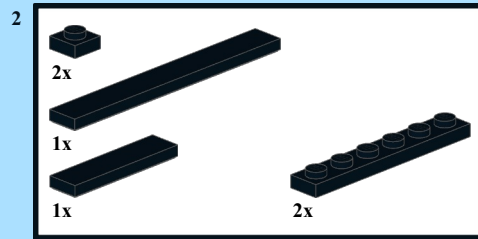
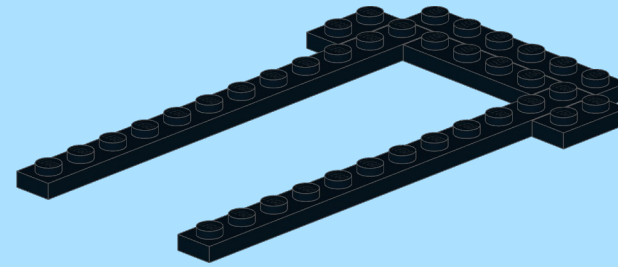
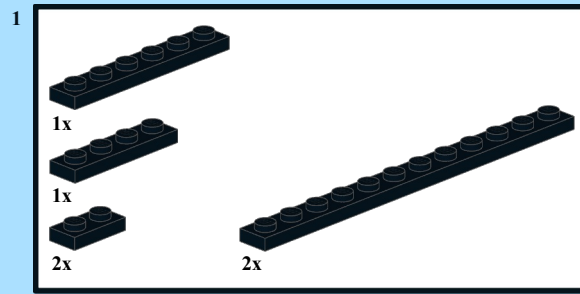

Design By: Filip Pienkowski

INSTRUCTION BY  
**KNUD ALBRECHTSEN**  
[www.snakebyte.dk/lego](http://www.snakebyte.dk/lego)





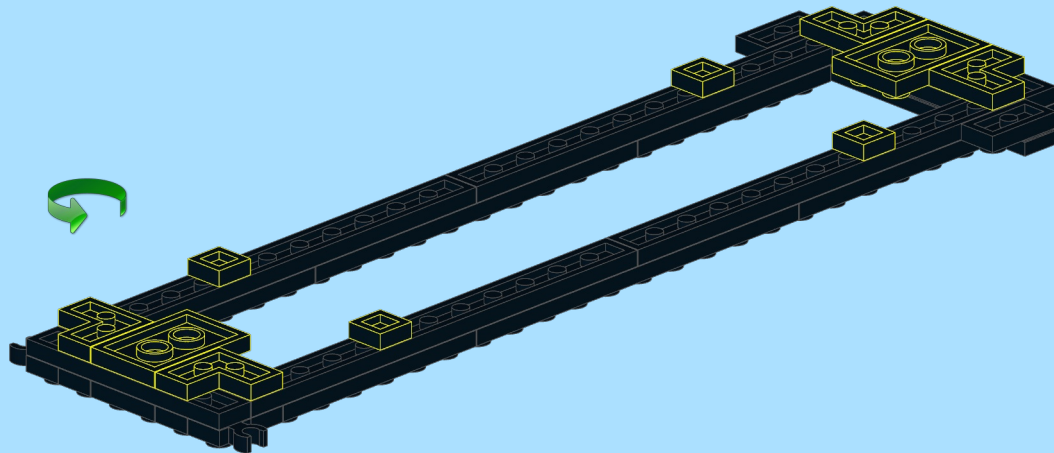

- 5
-  2x
  -  4x
  -  4x

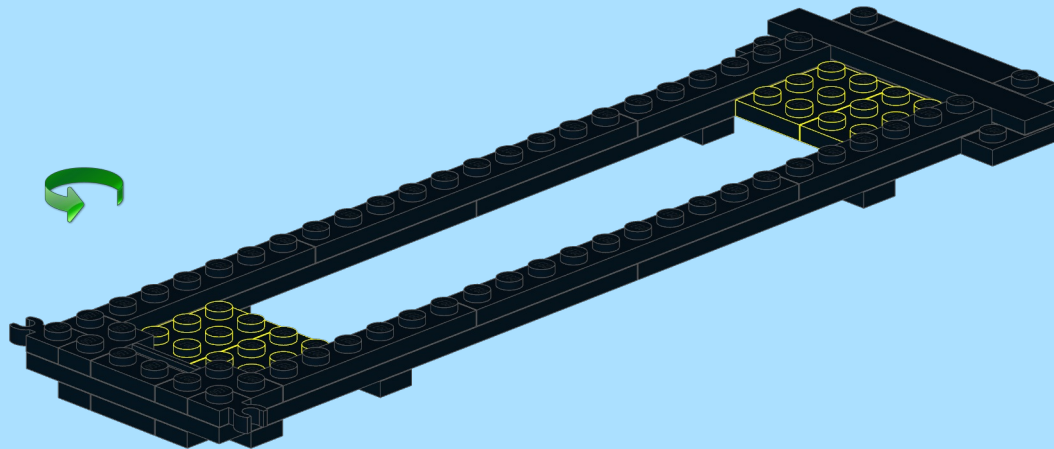

- 6
-  4x





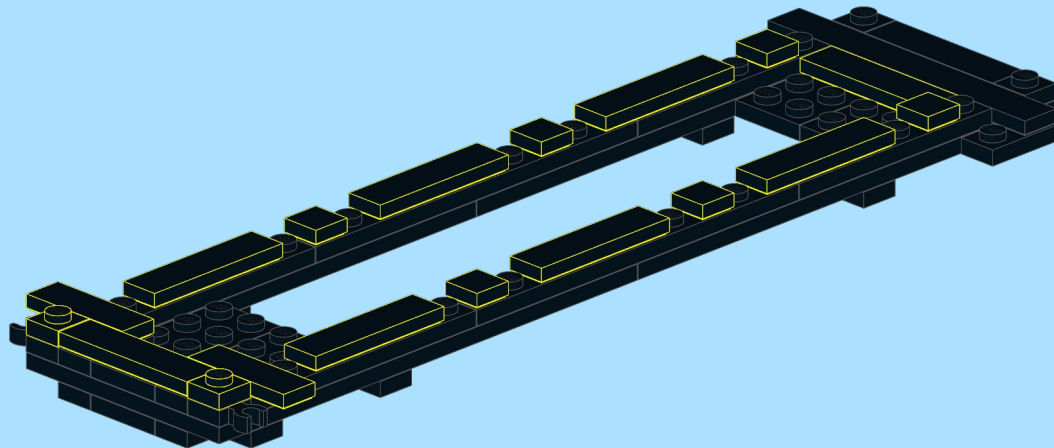

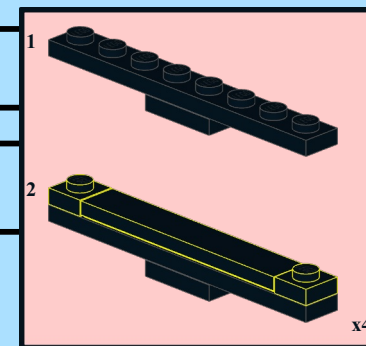
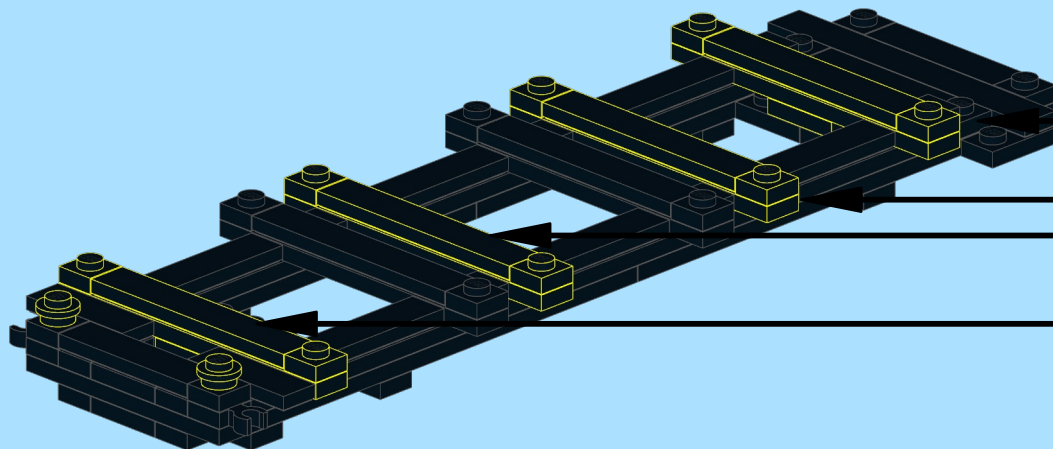
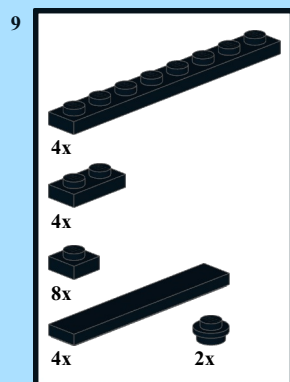
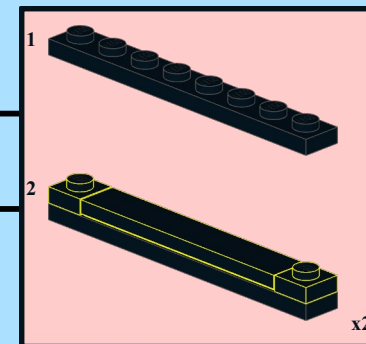
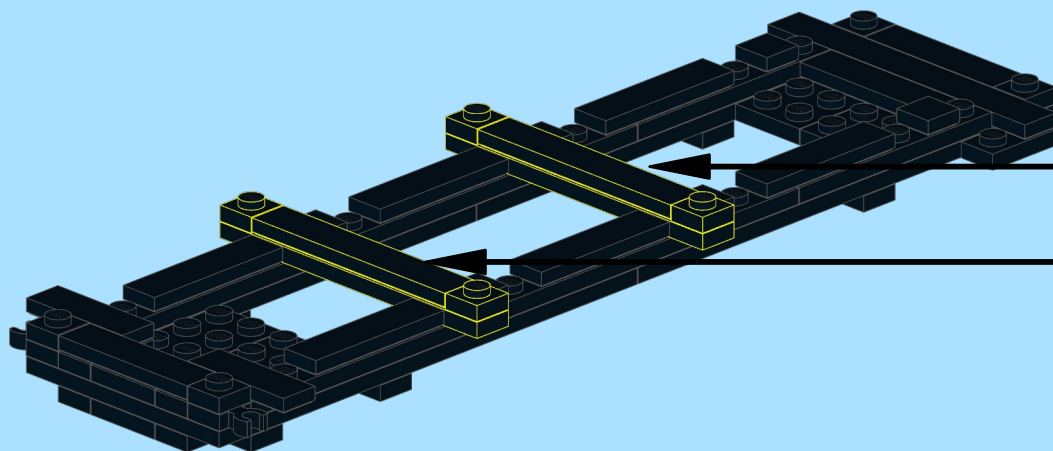
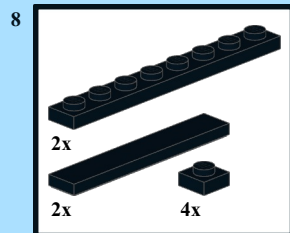

- 7
-  2x
  -  8x
  -  2x
  -  6x











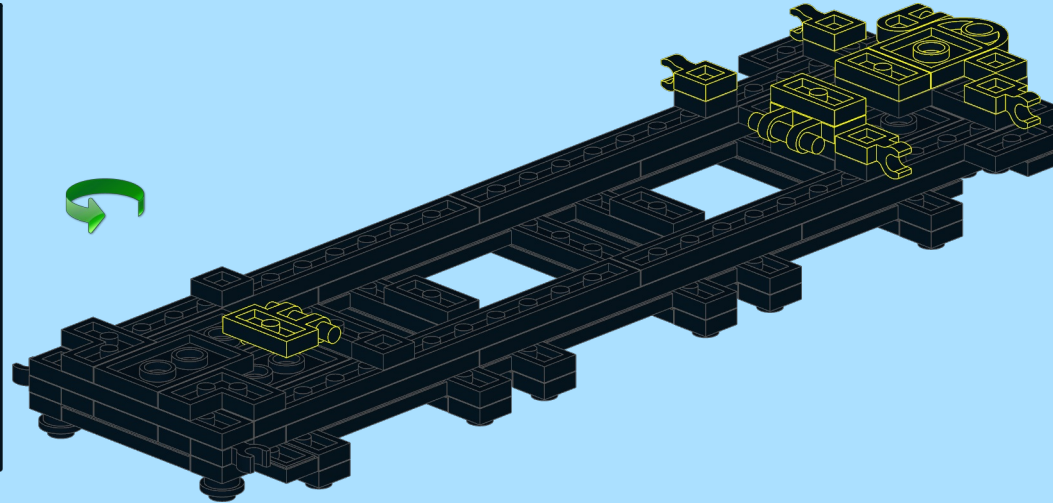

10

-  1x
-  2x
-  2x
-  1x
-  4x
-  1x



11

-  1x
-  2x
-  1x
-  4x
-  1x

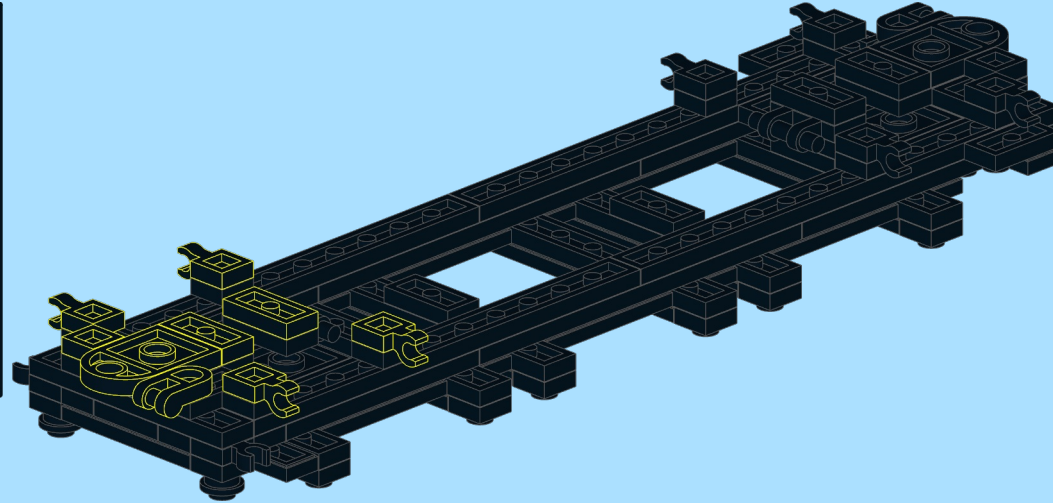

12

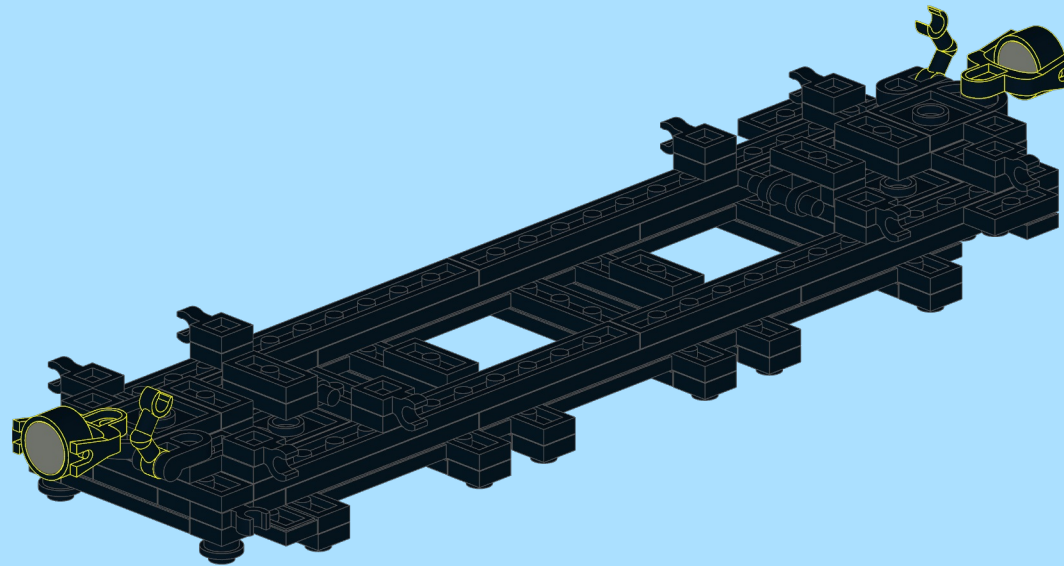
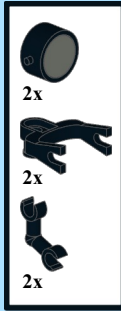

13

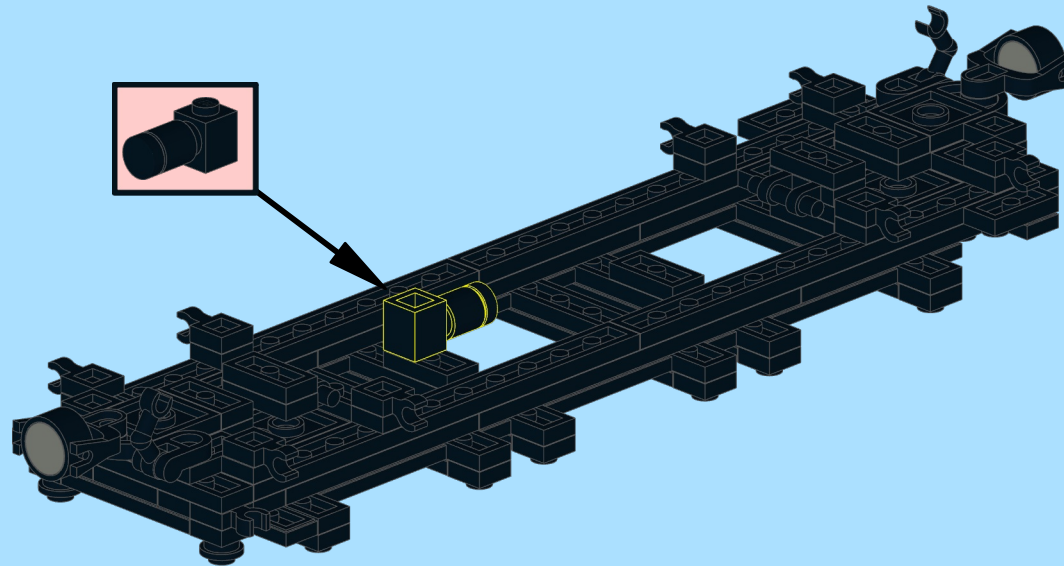
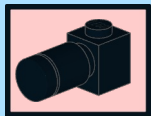

14

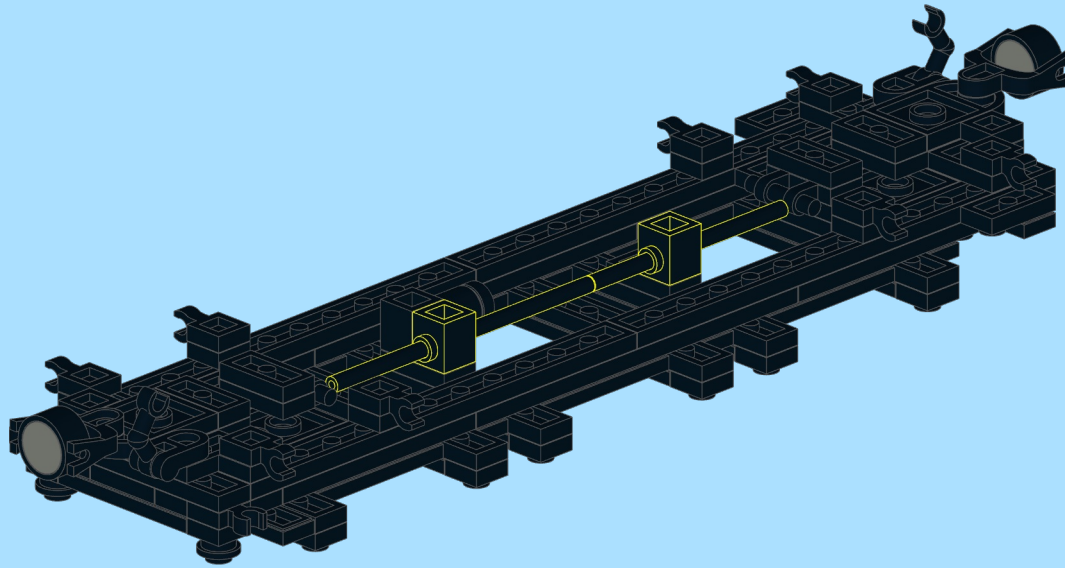

15

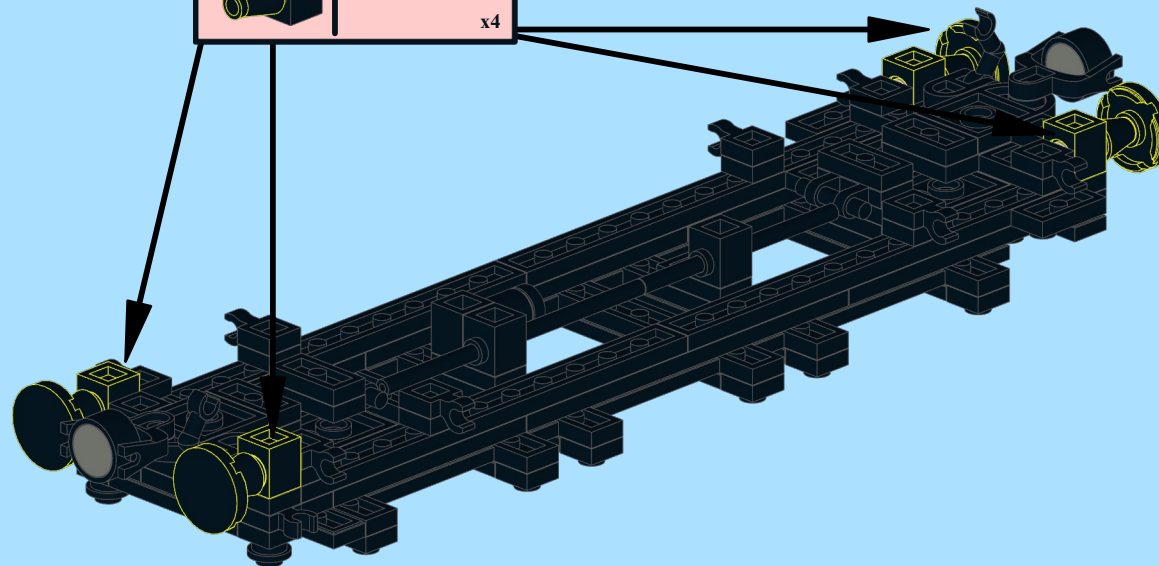
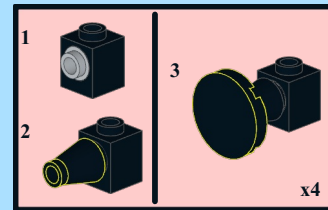





18

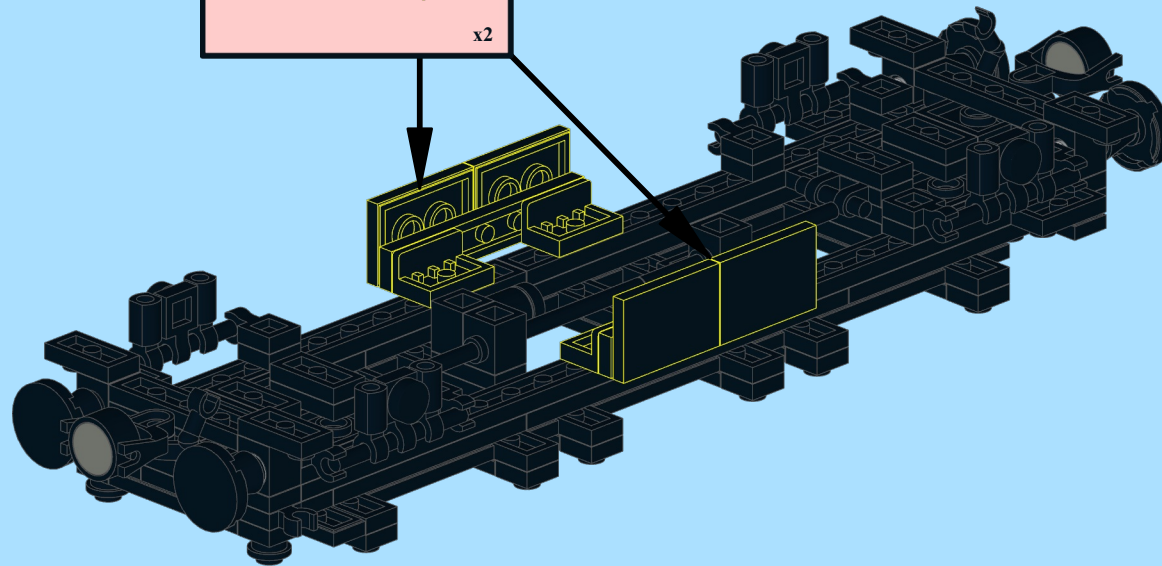
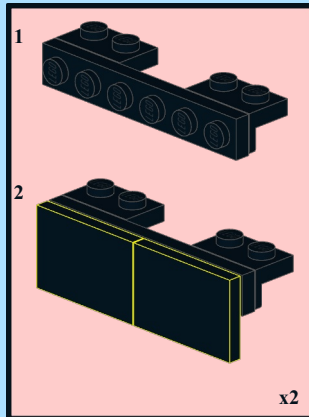
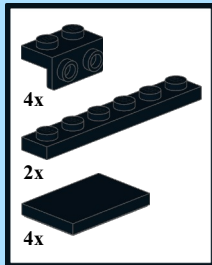

19

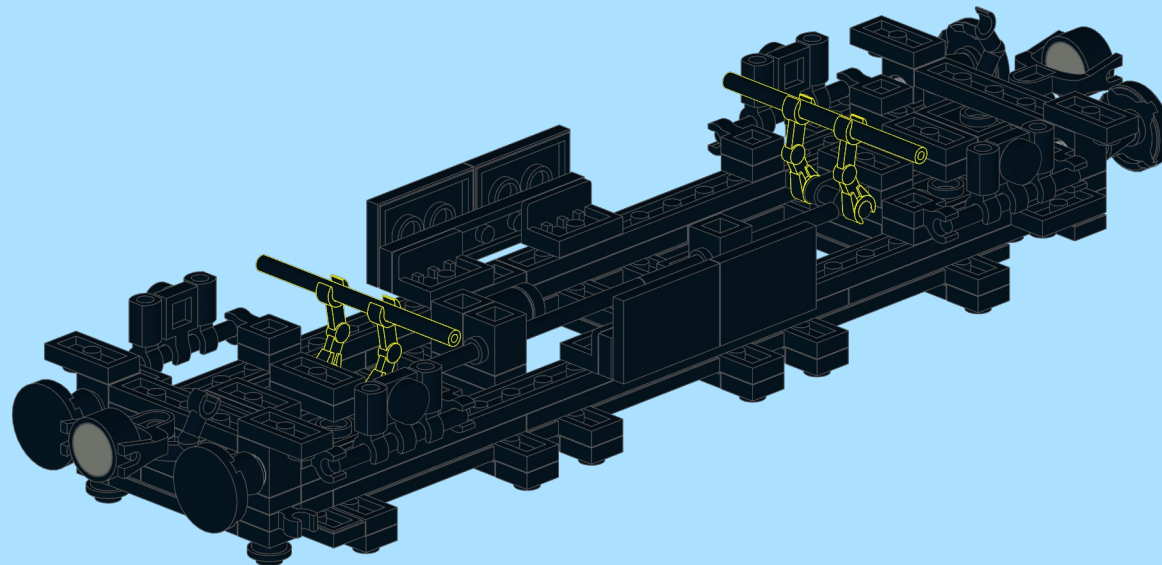

20

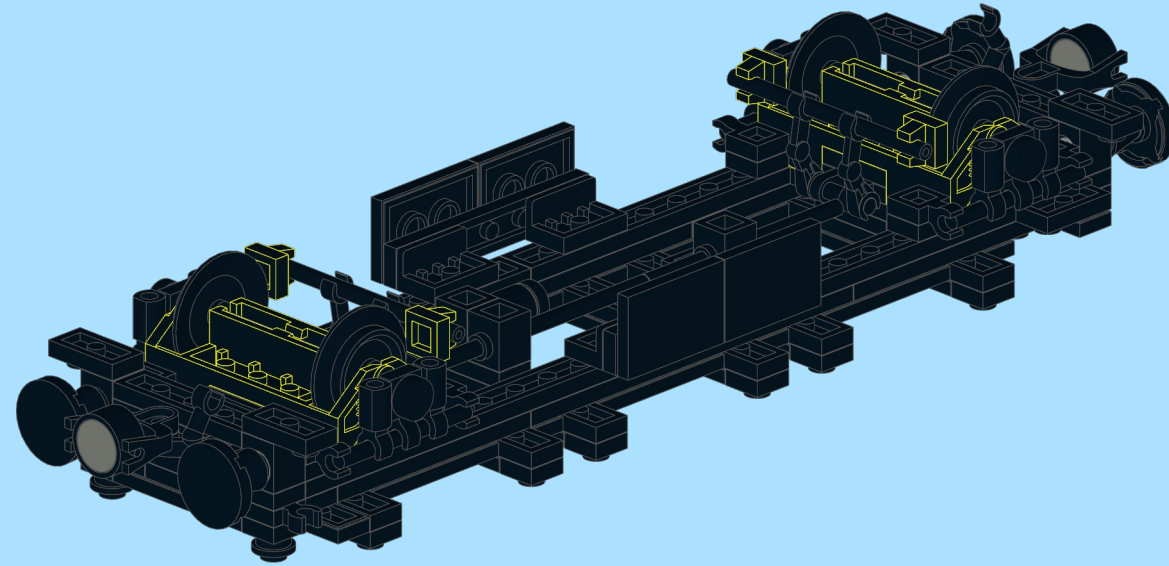
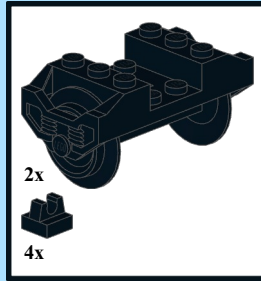

21

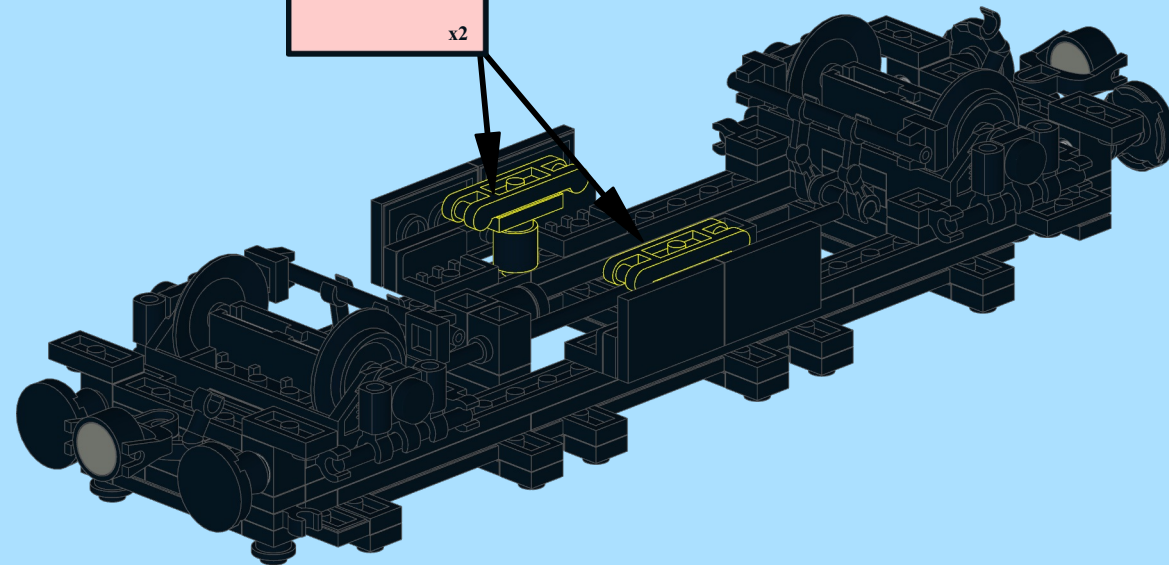
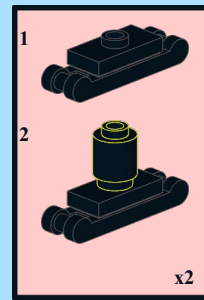
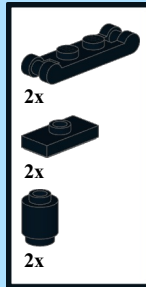

22

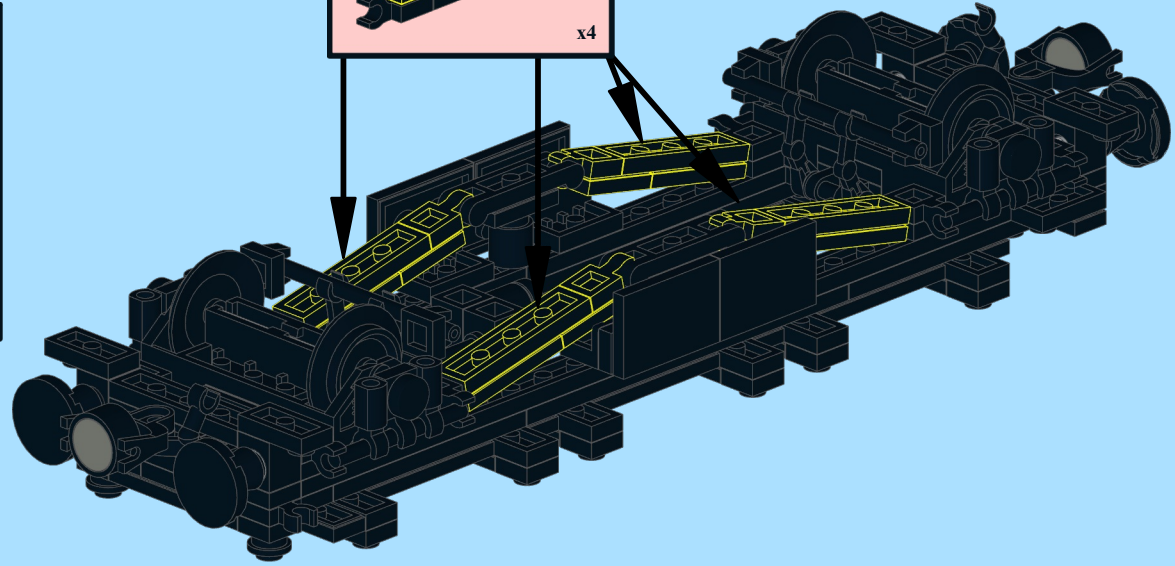
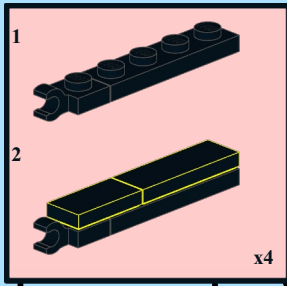
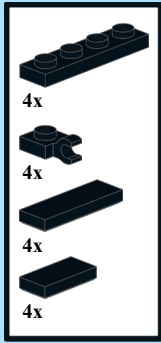

23

