

# Emerald Night Cargo Car



Design By: Jesper Burgdorff  
At byggepladen.dk

INSTRUCTION BY  
**KNUD ALBRECHTSEN**  
[www.snakebyte.dk/lego](http://www.snakebyte.dk/lego)

1

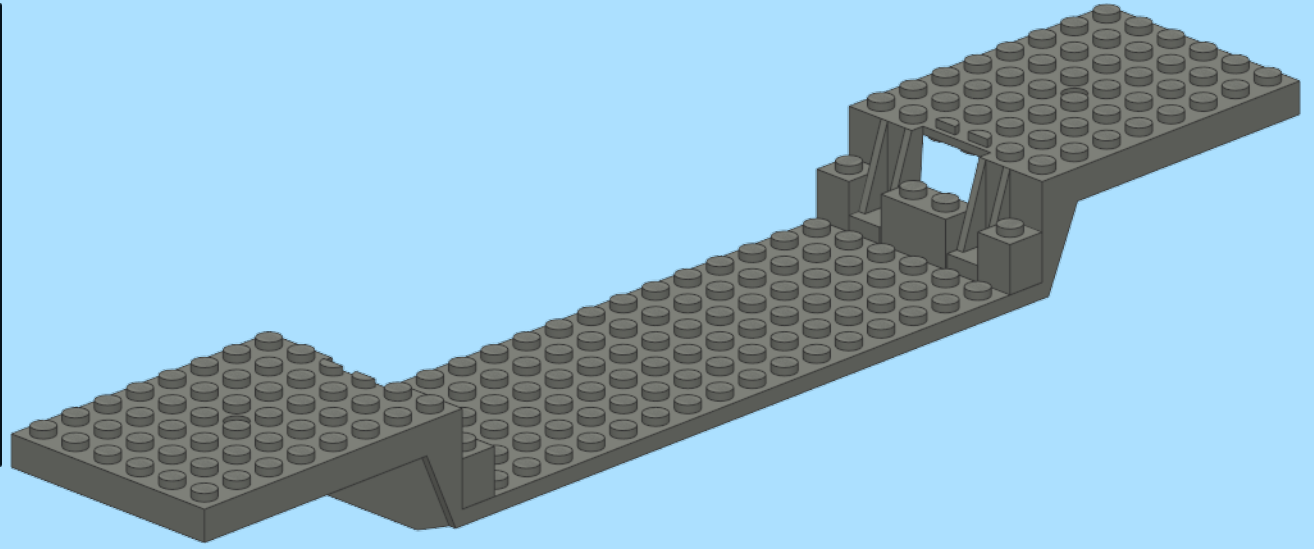
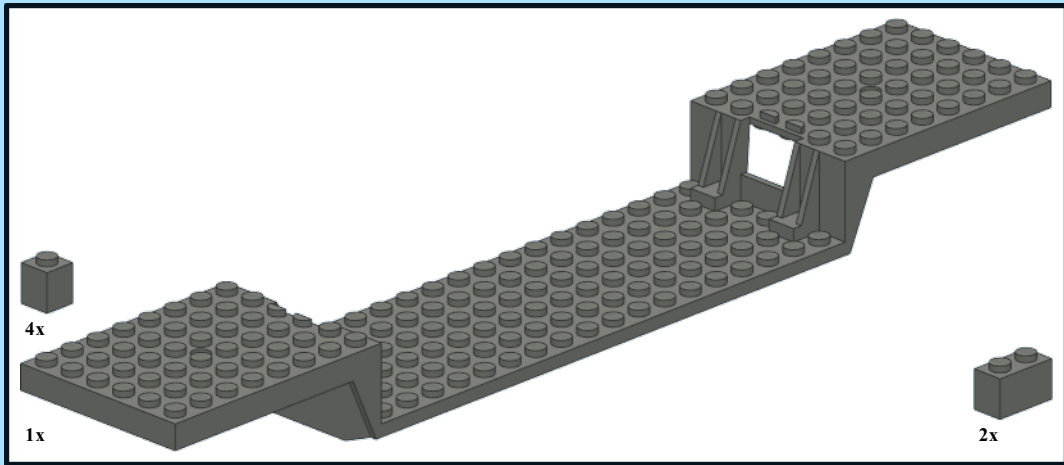



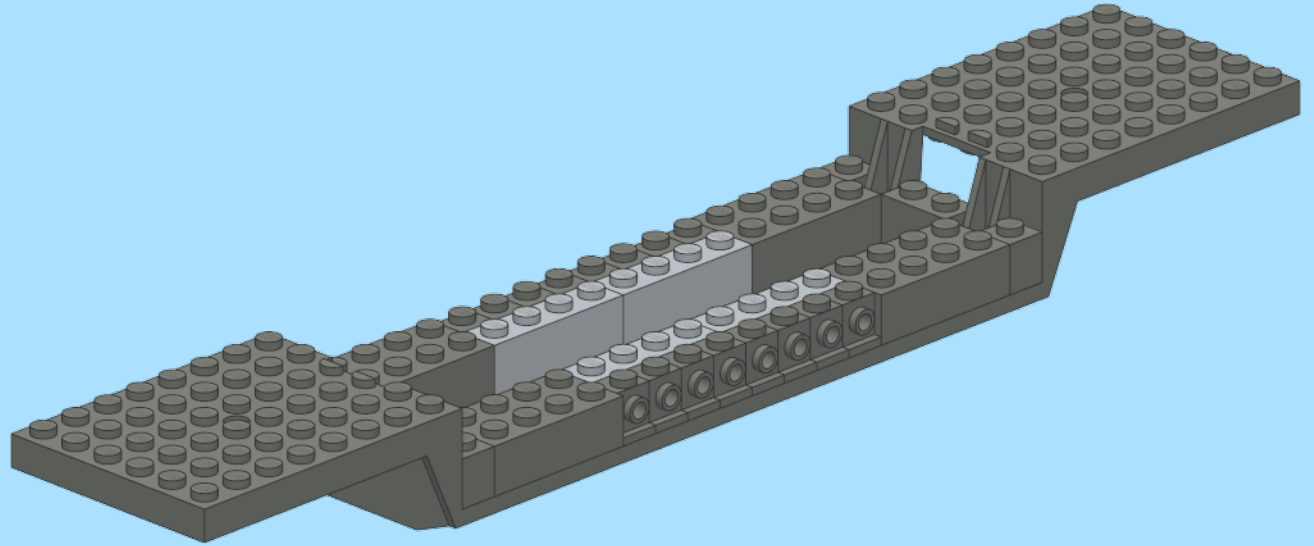
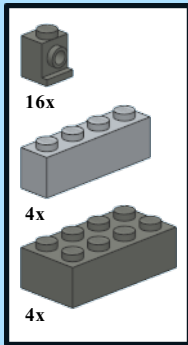

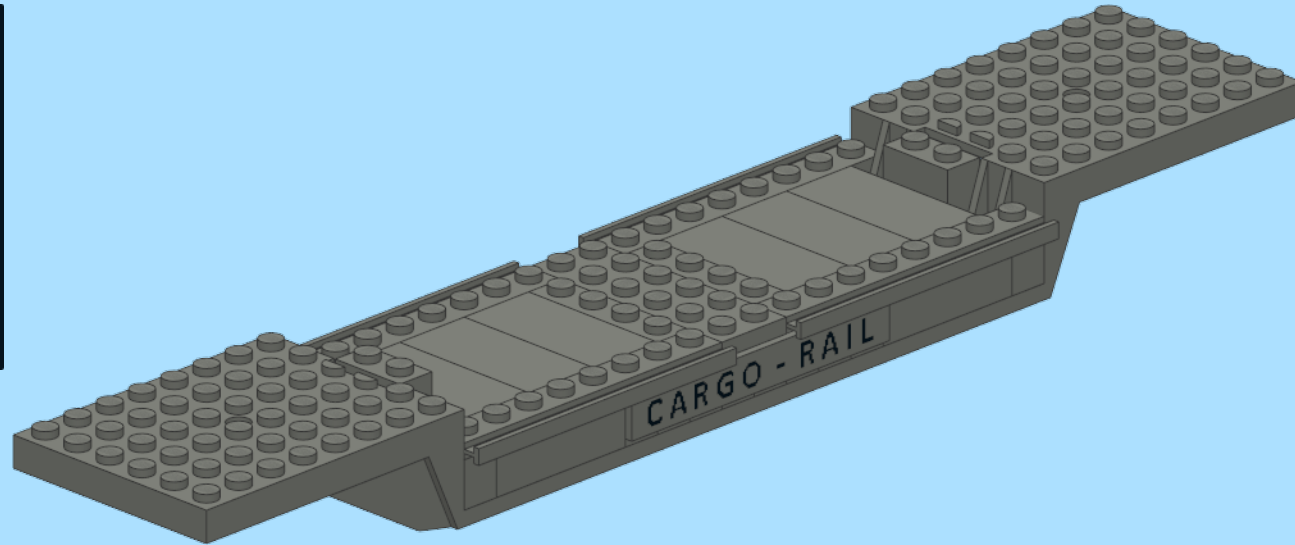
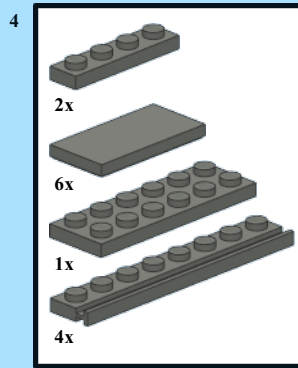
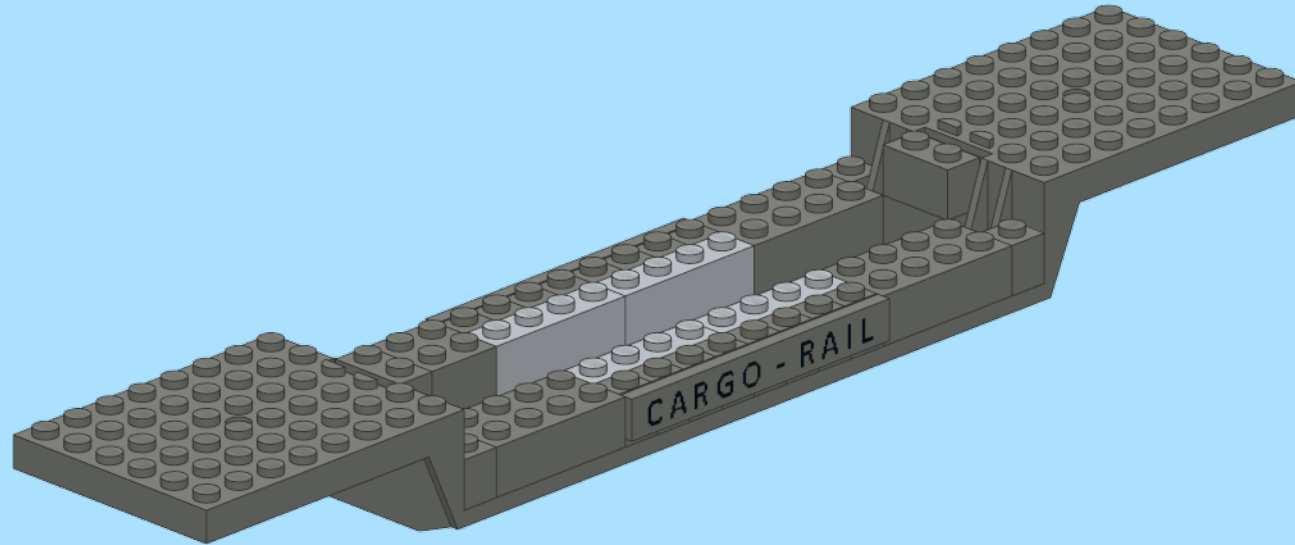
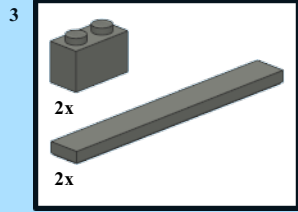
2

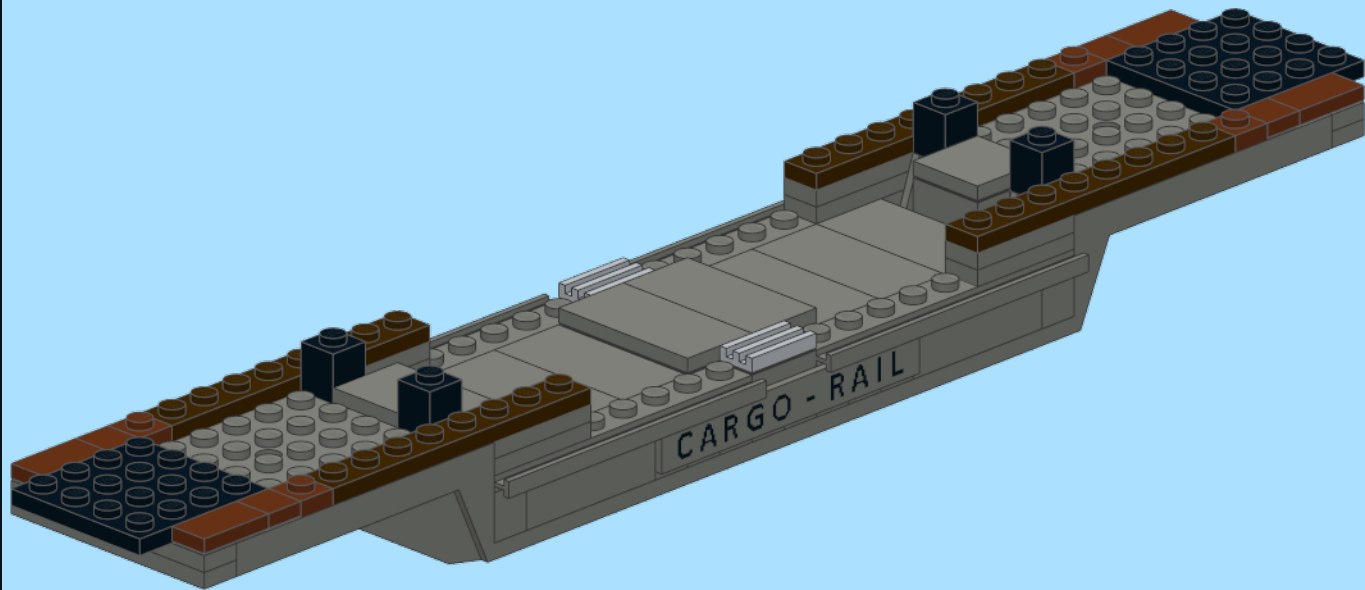
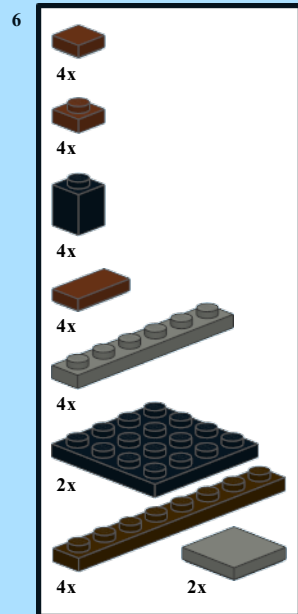
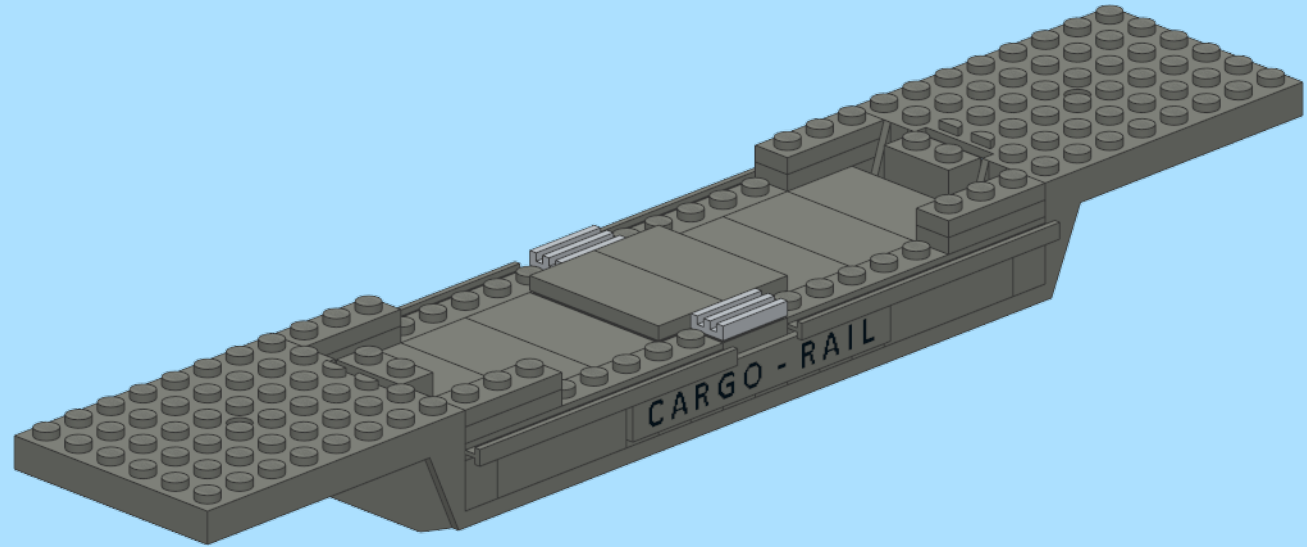
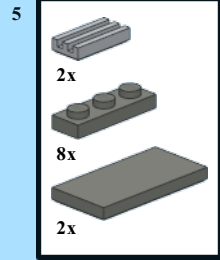







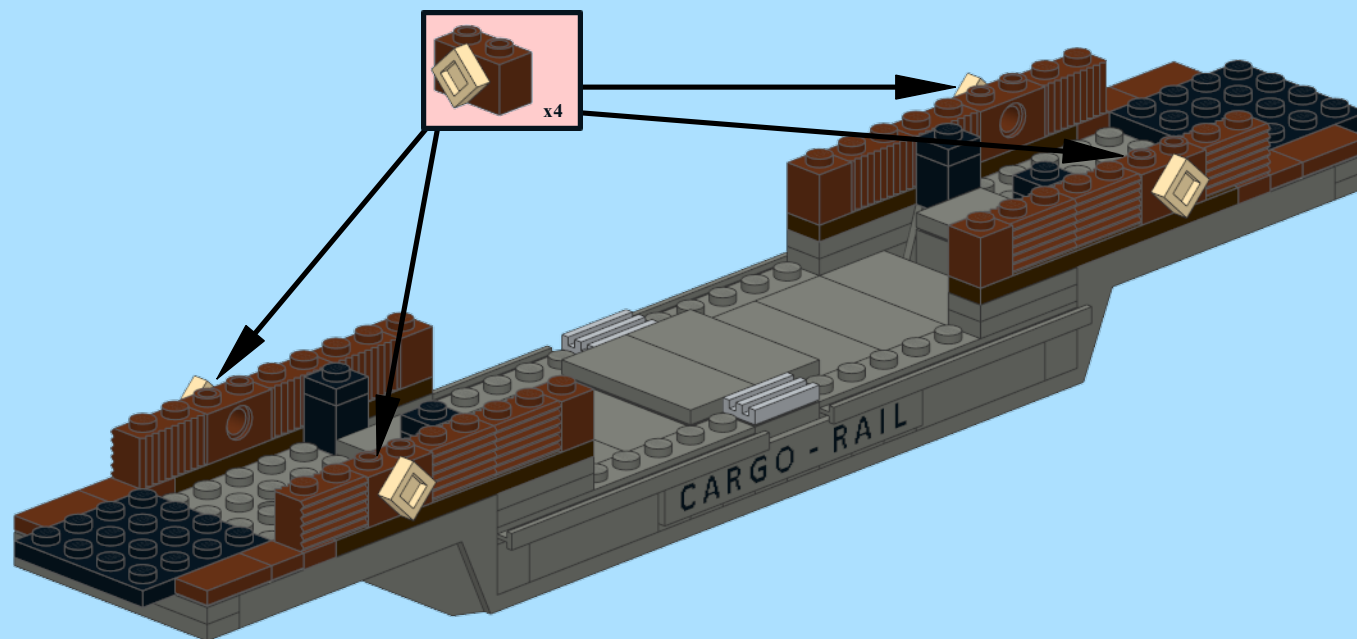

- 7
-  4x
  -  4x
  -  4x
  -  12x
  -  4x

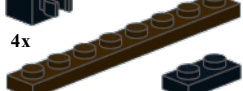

- 8
-  4x
  -  4x
  -  4x
  -  4x
  -  4x

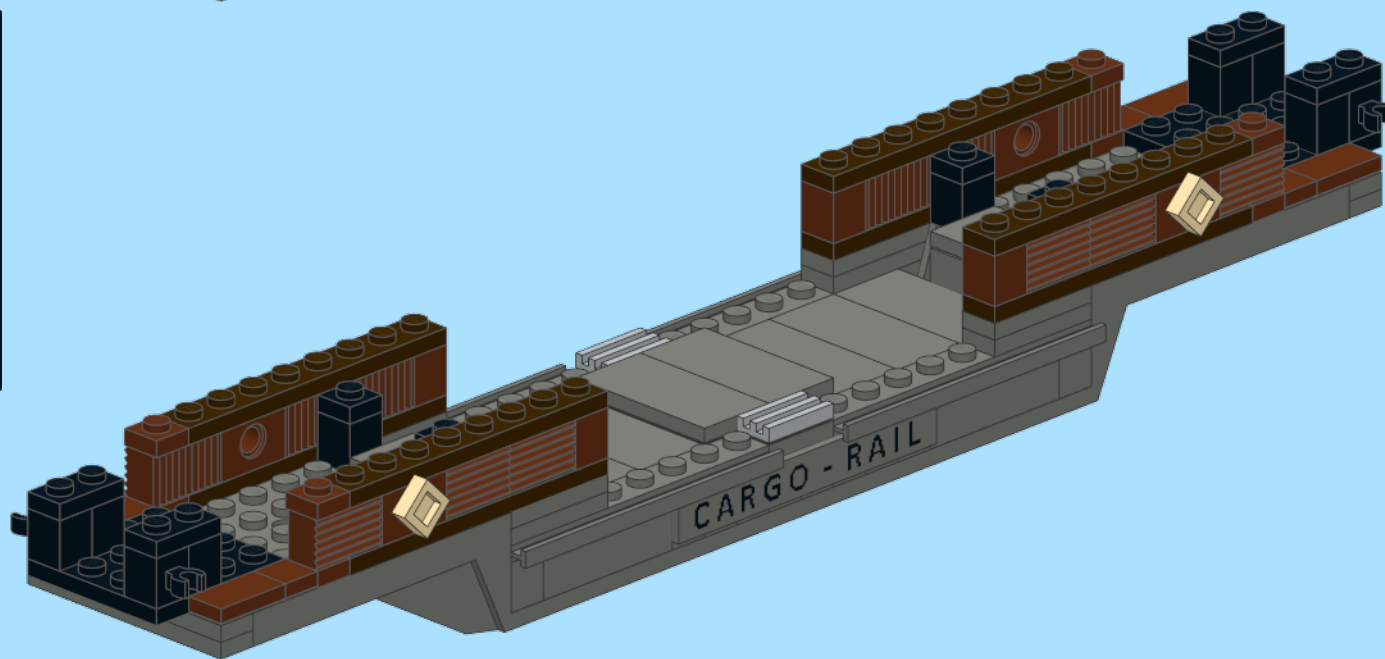

9

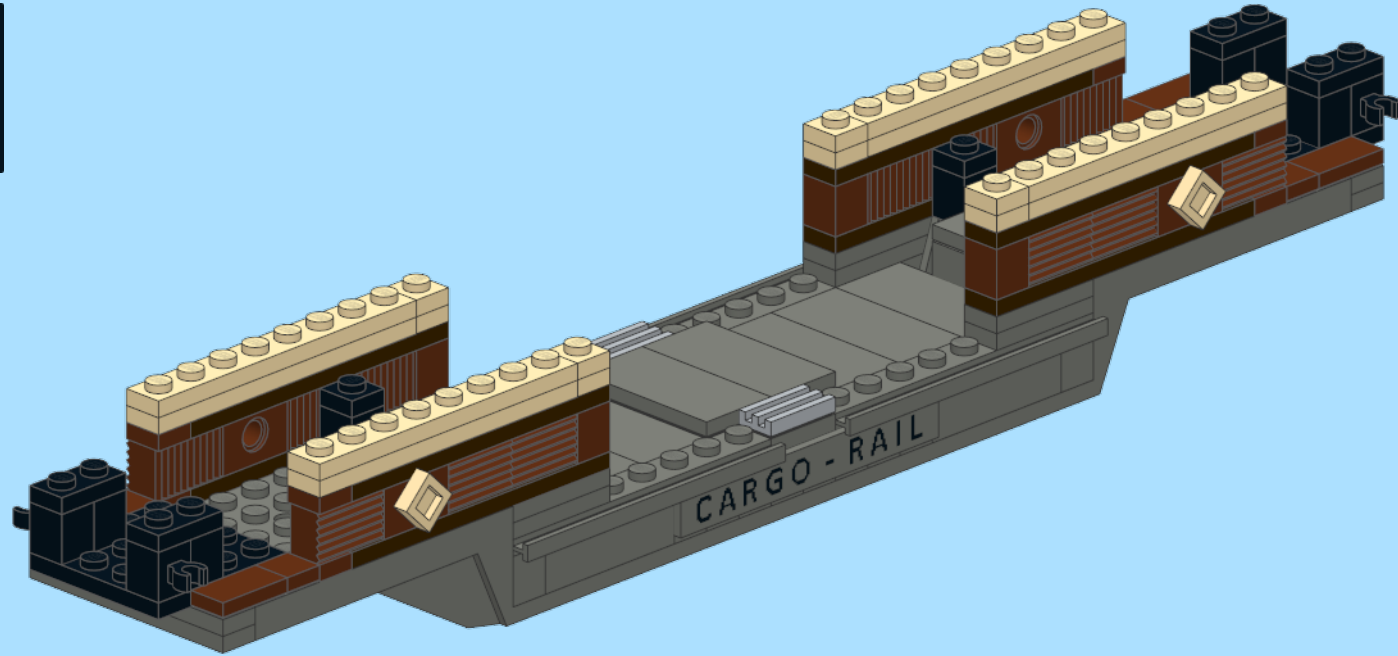
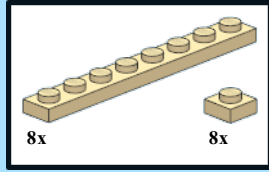

10

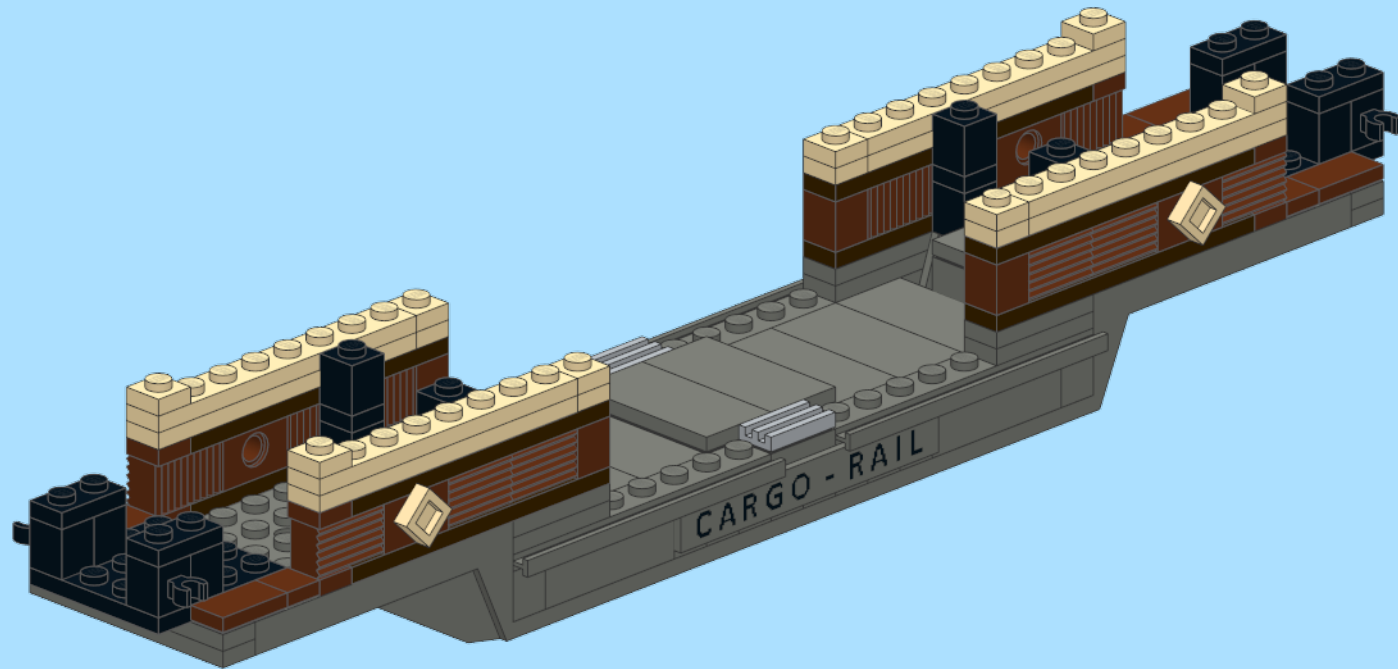

11

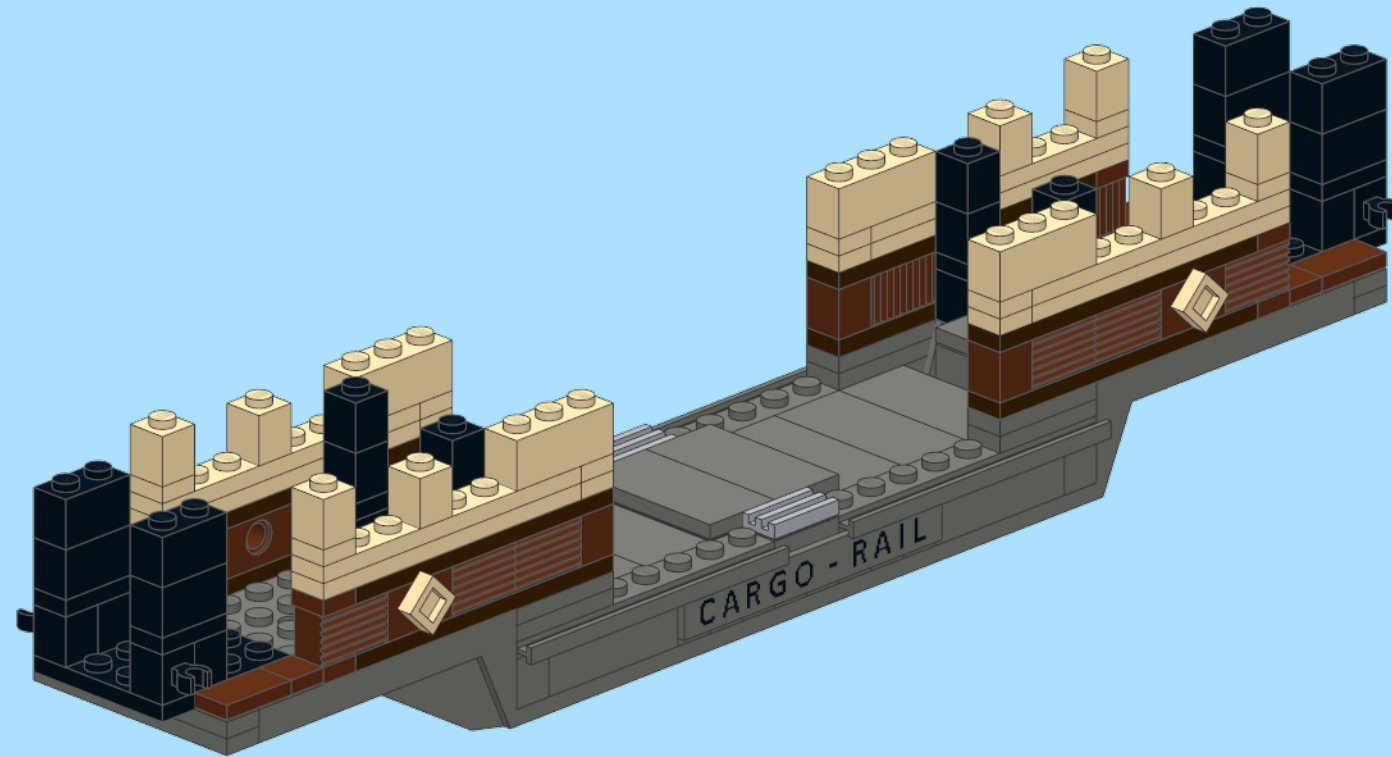
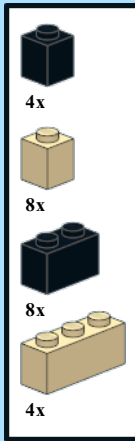

12

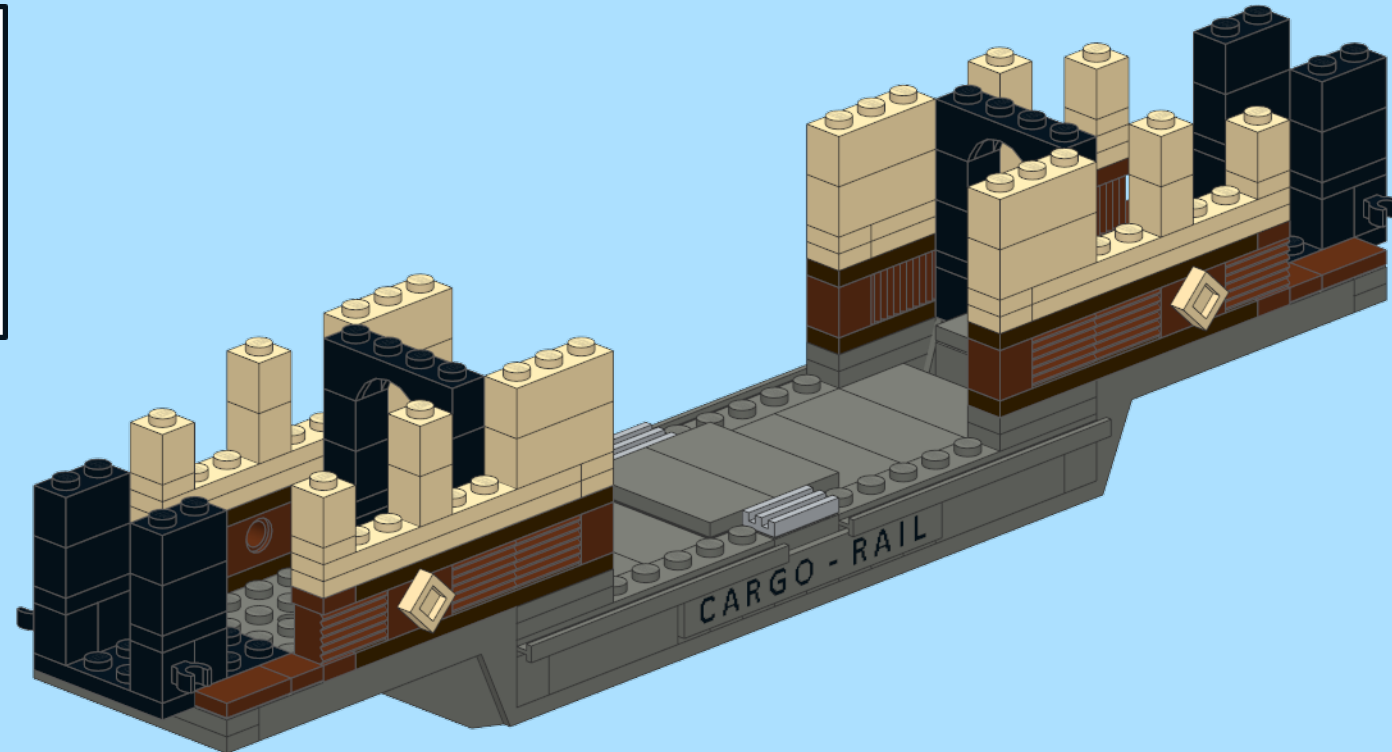
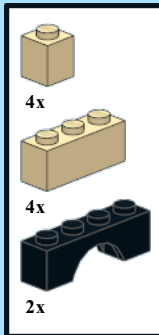

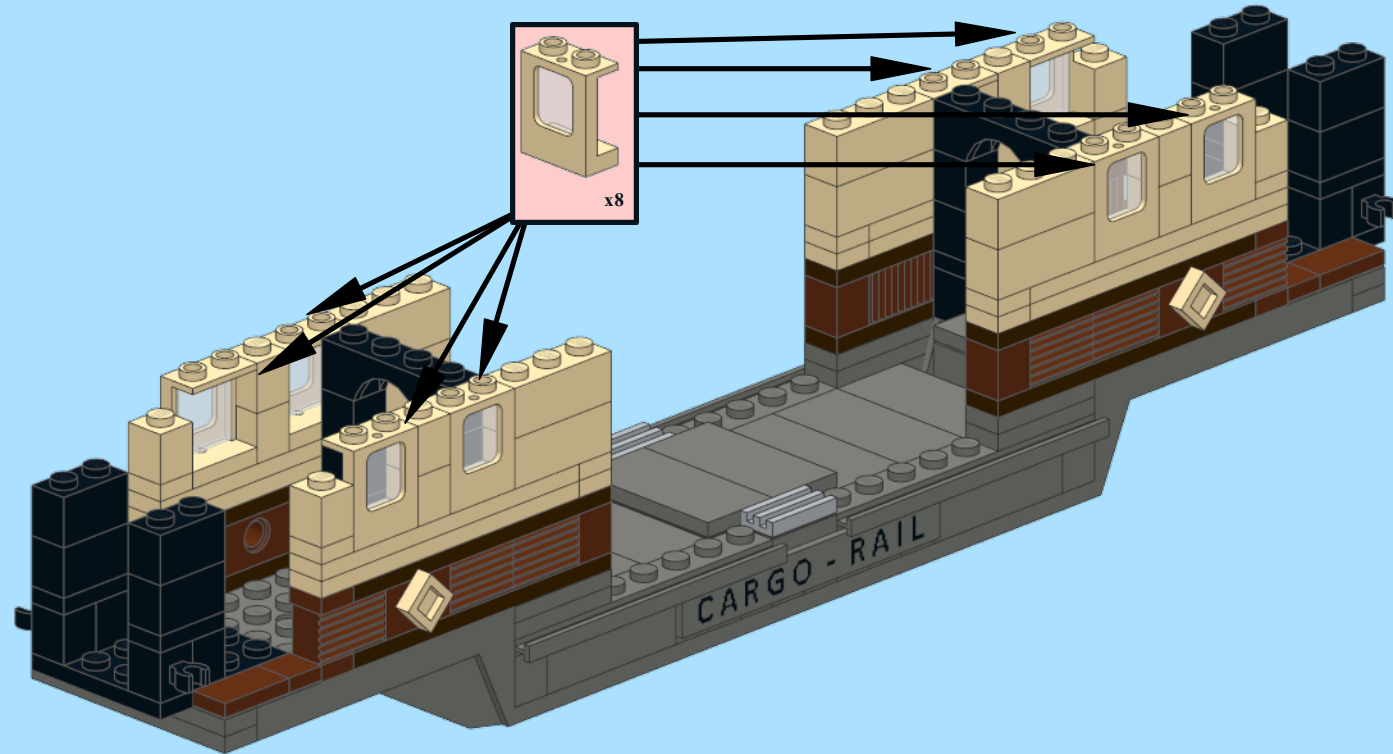
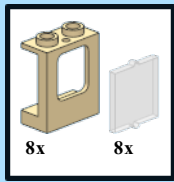



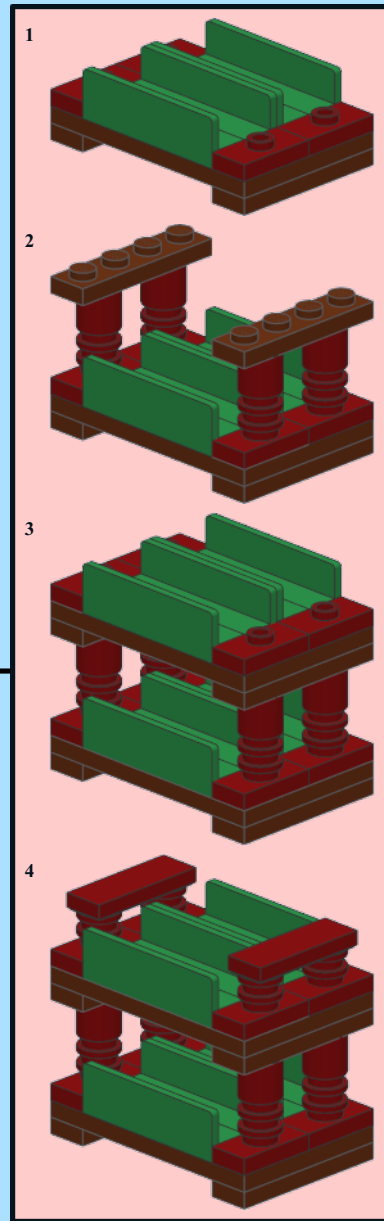
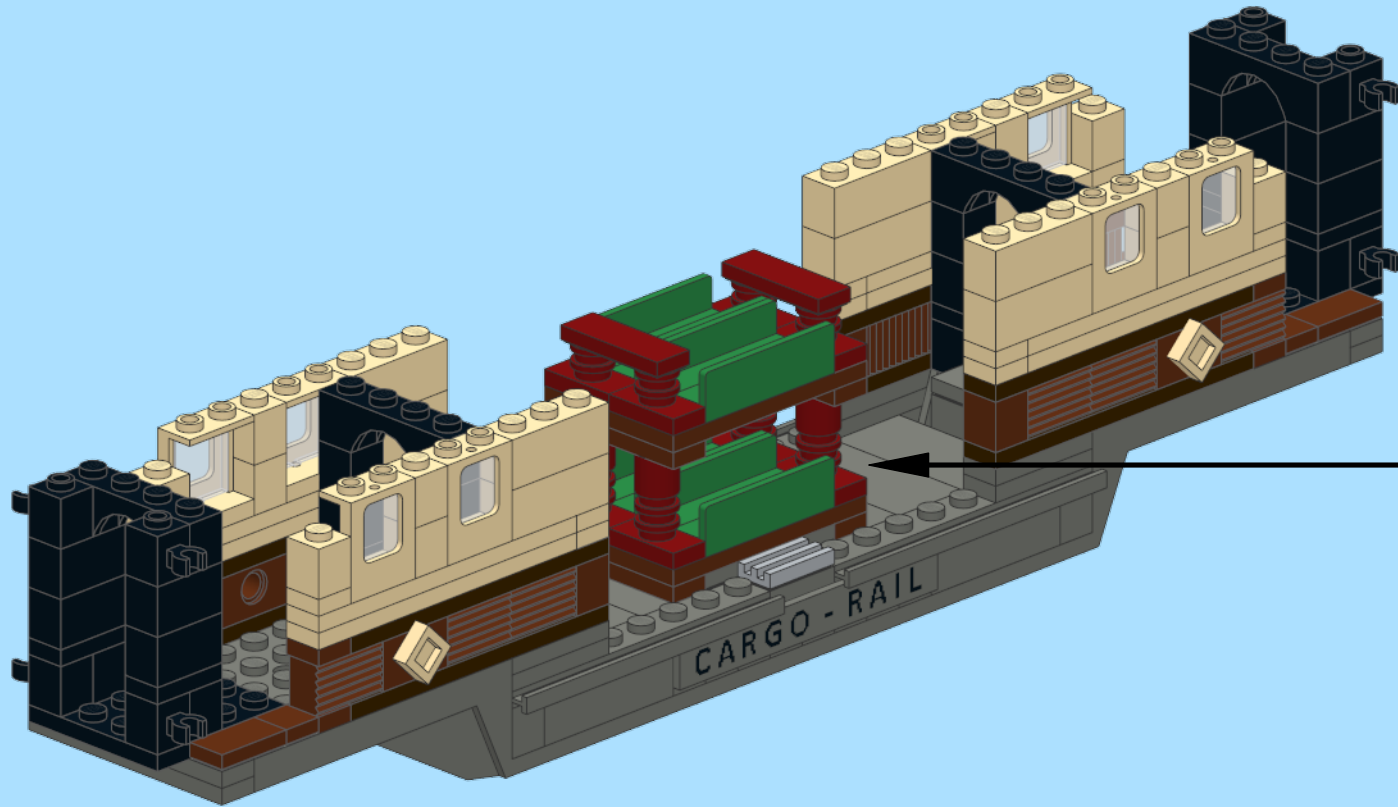
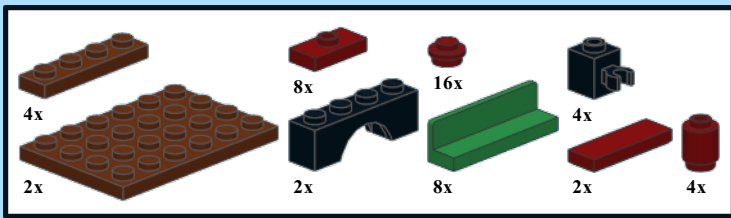

15

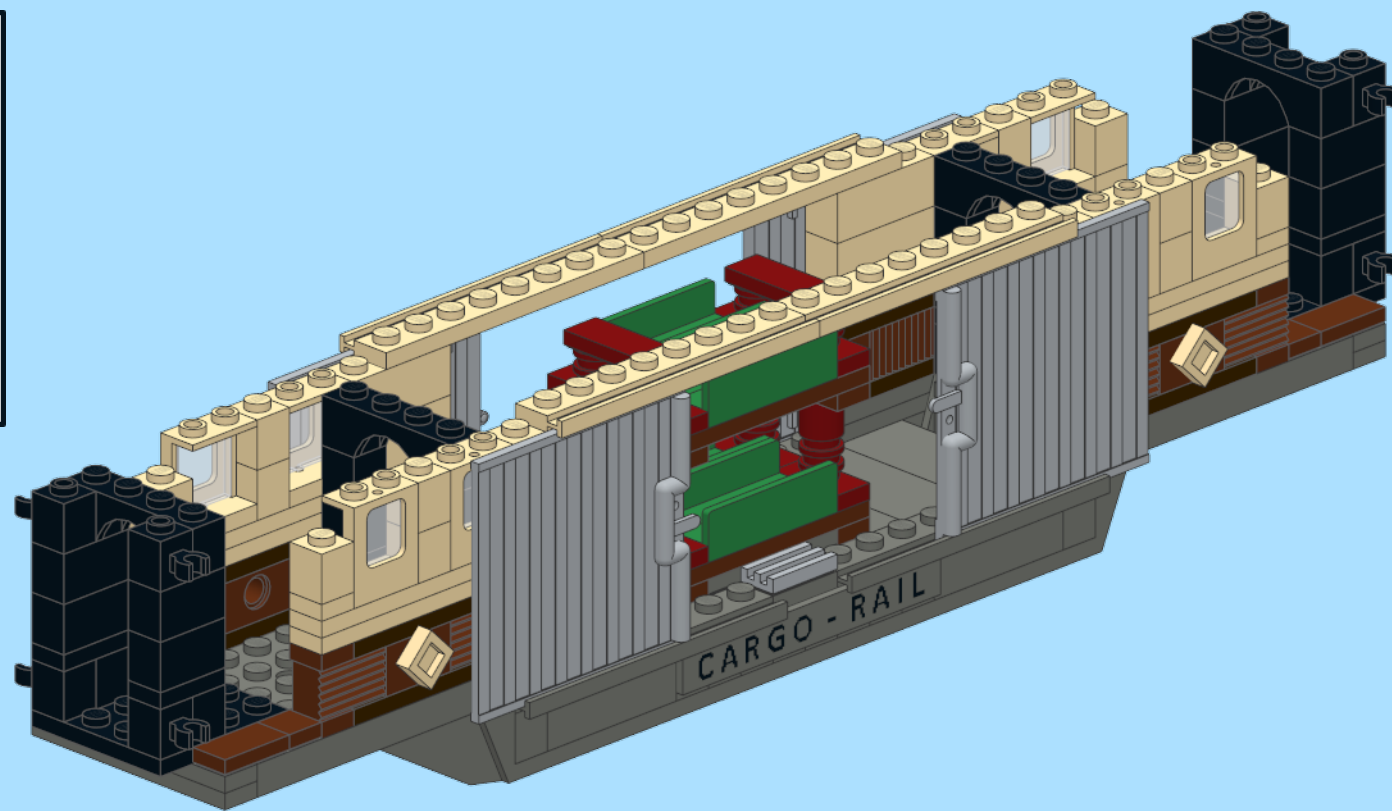
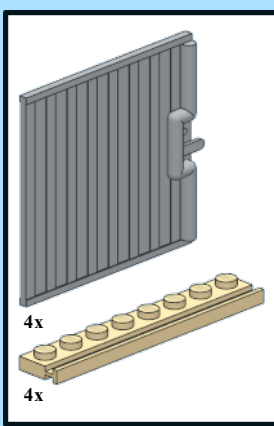

16

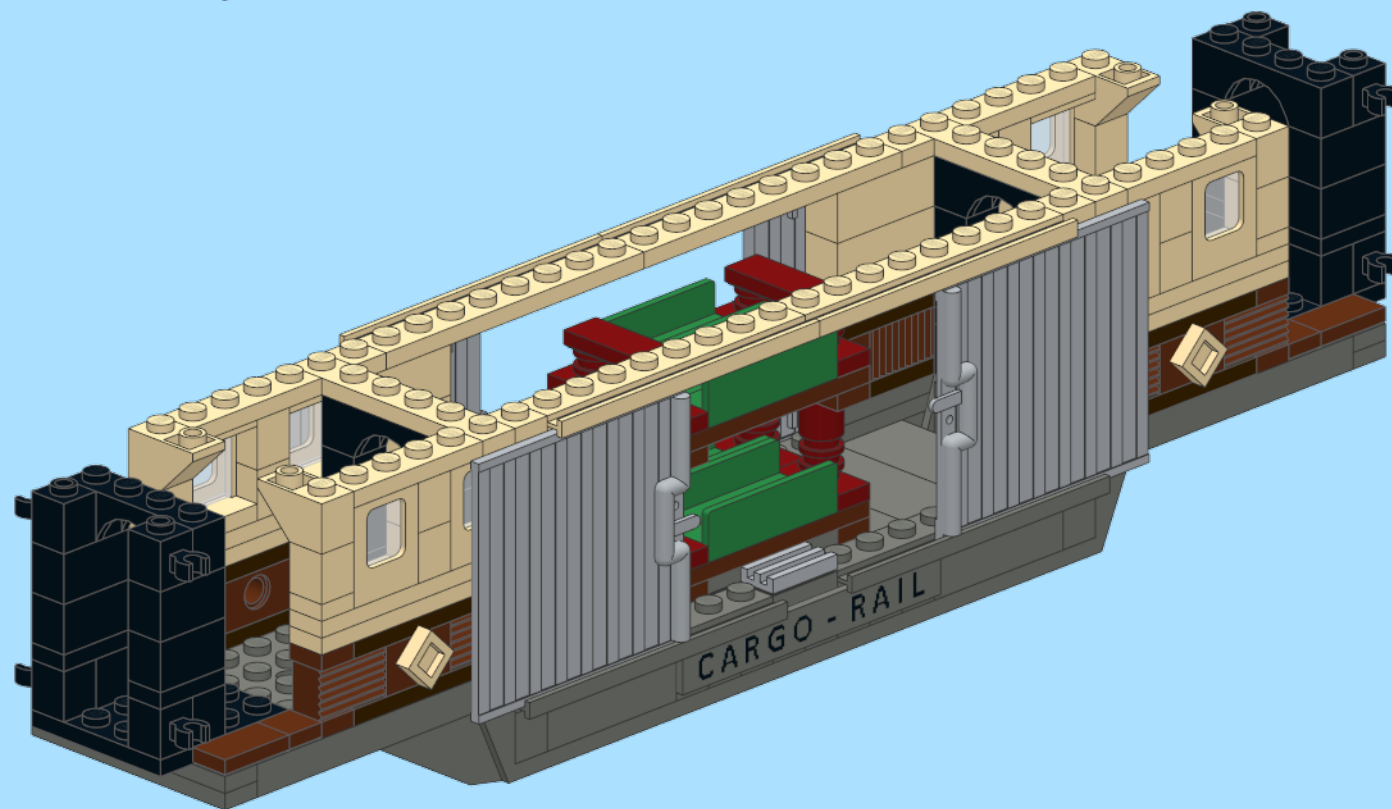
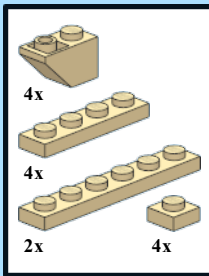

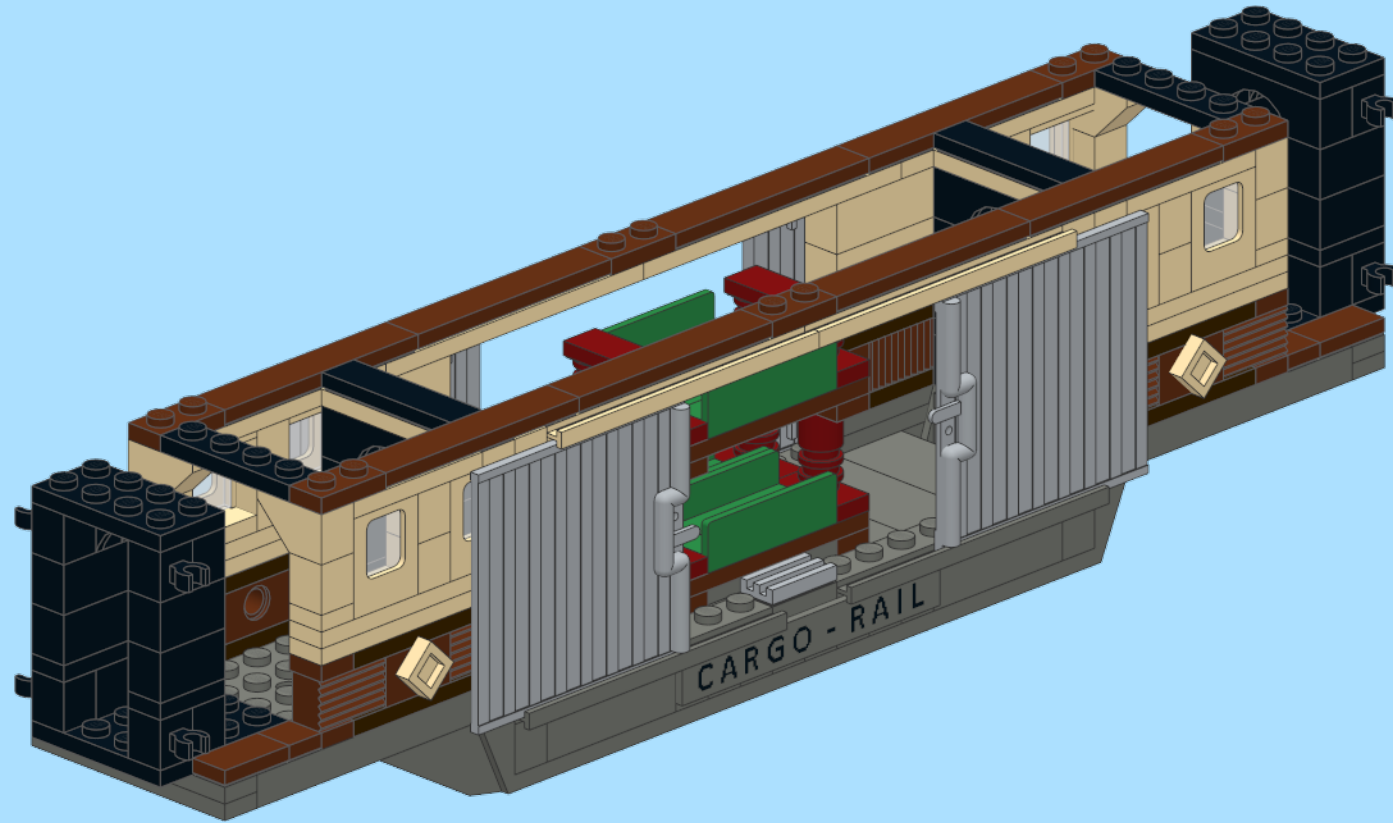
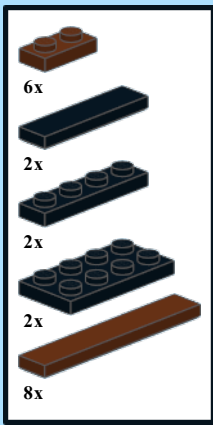

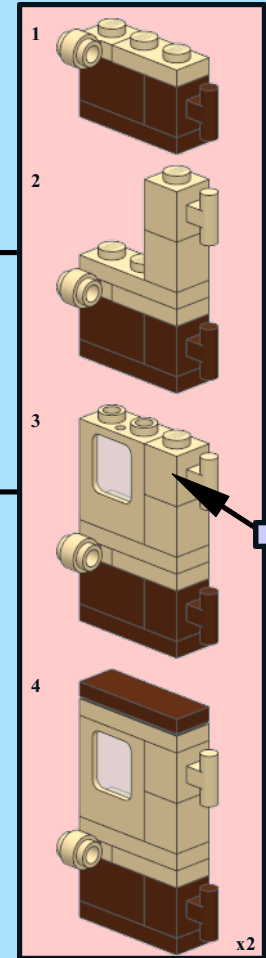
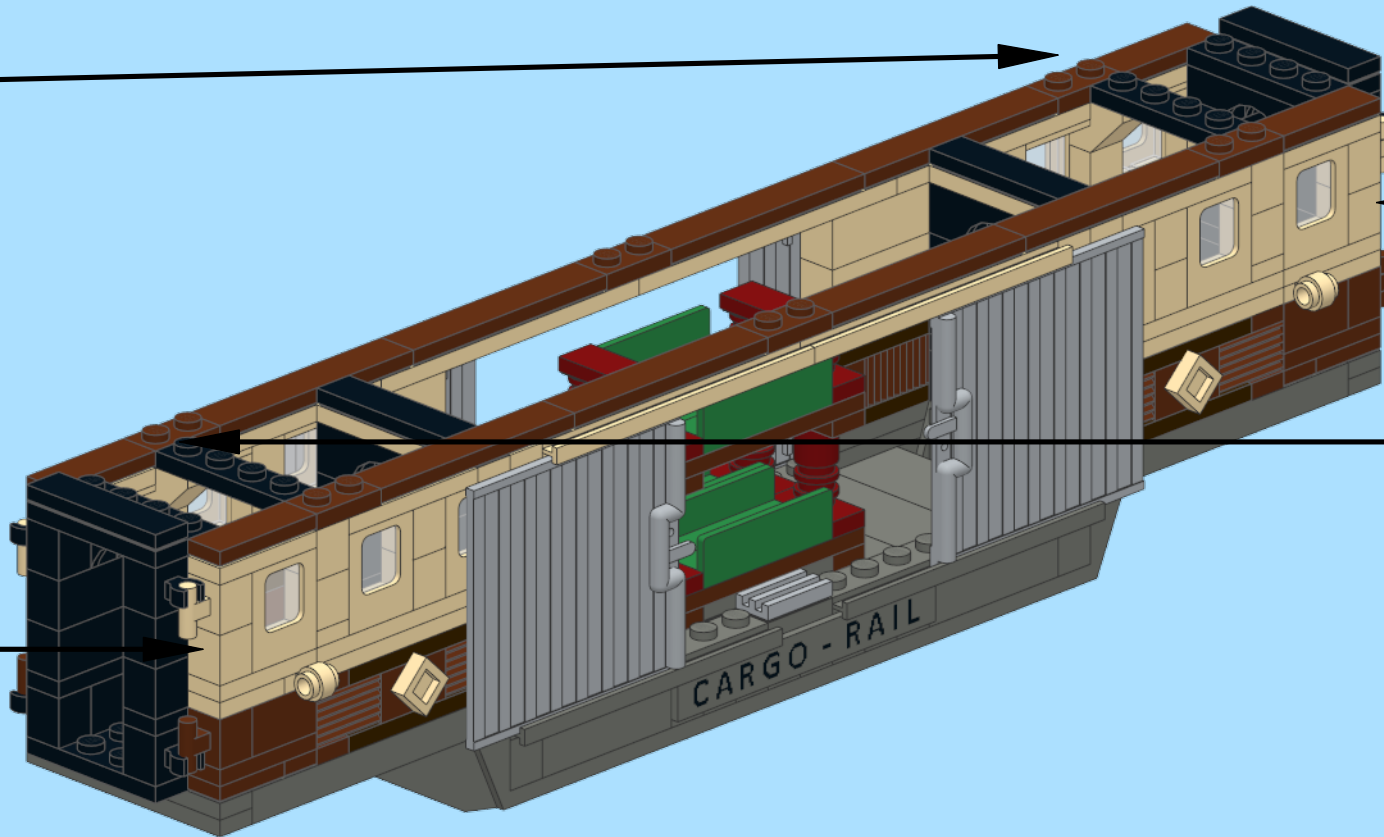
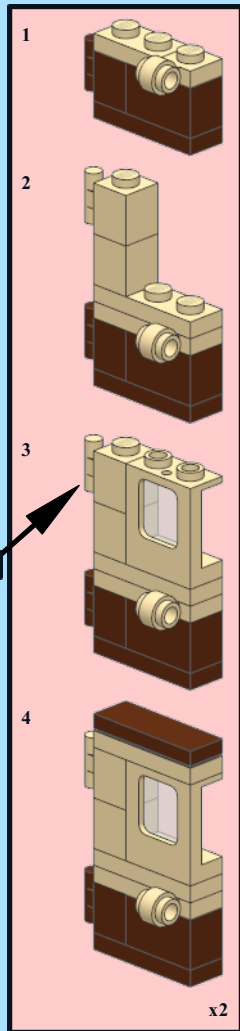
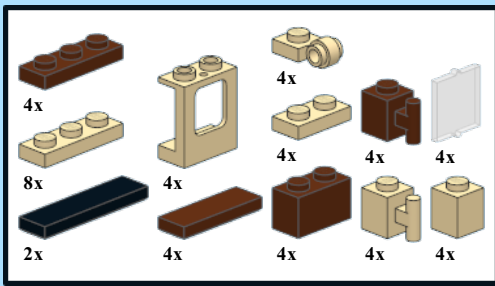

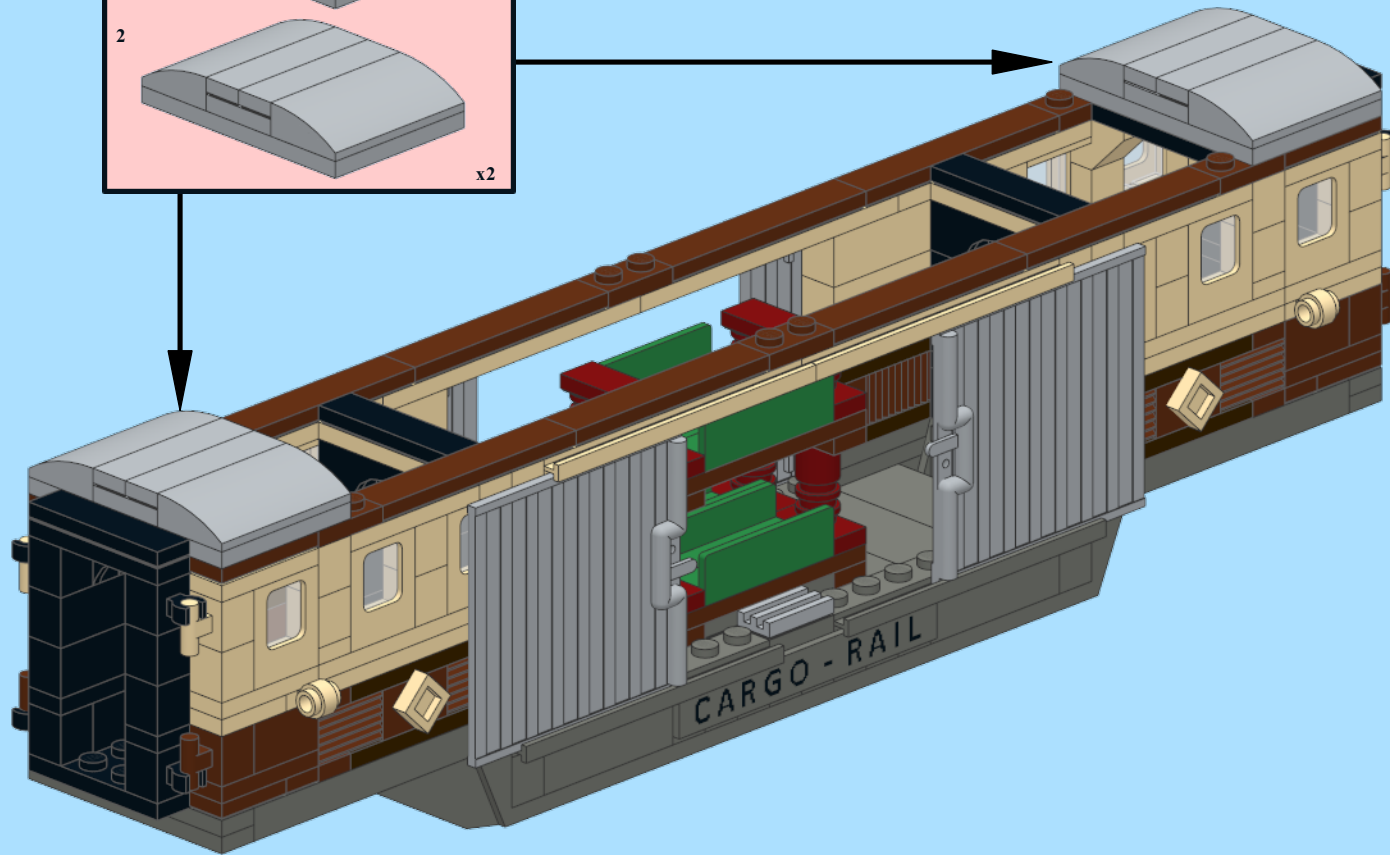
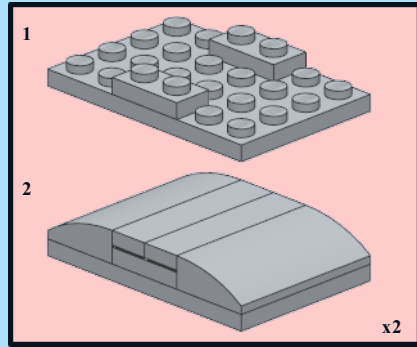
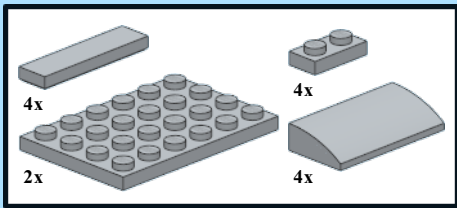

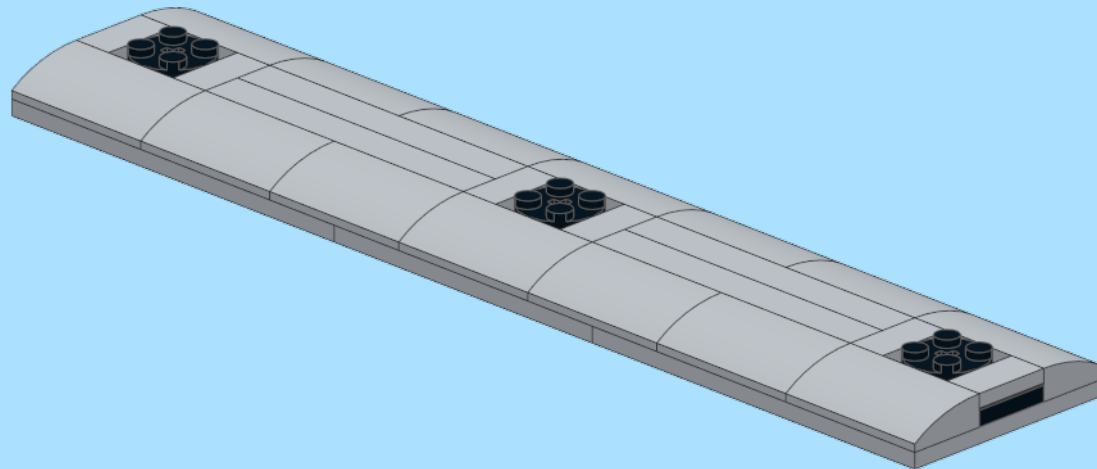
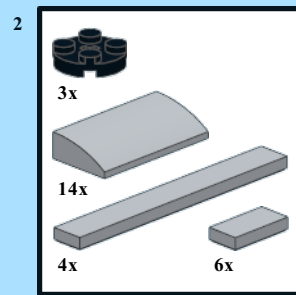
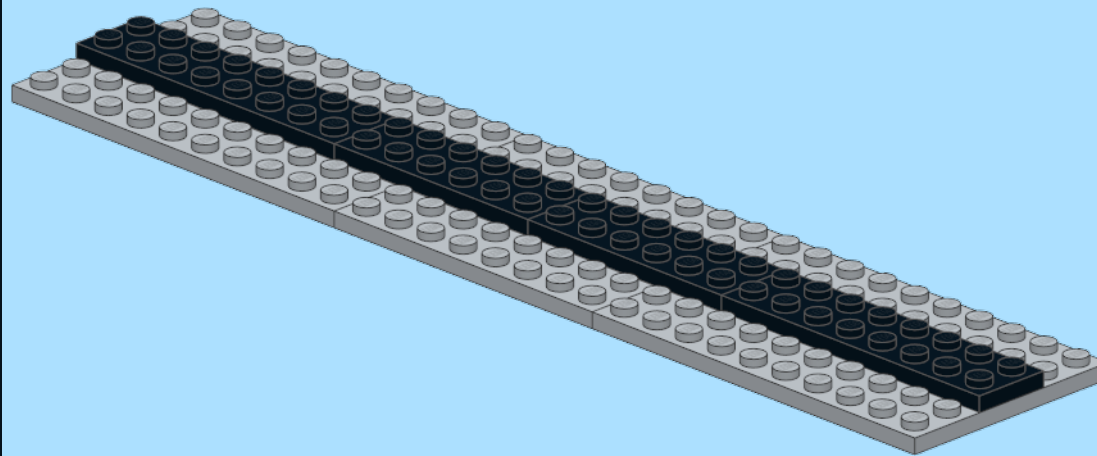
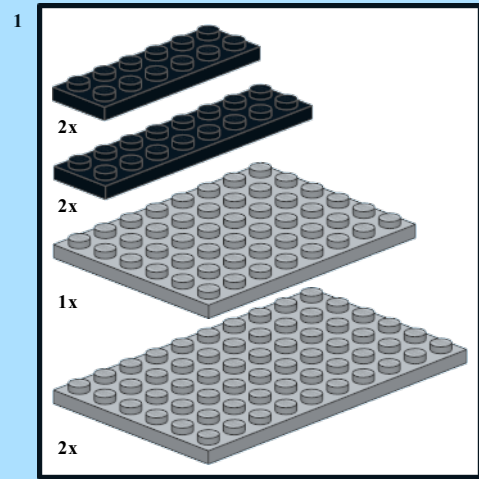

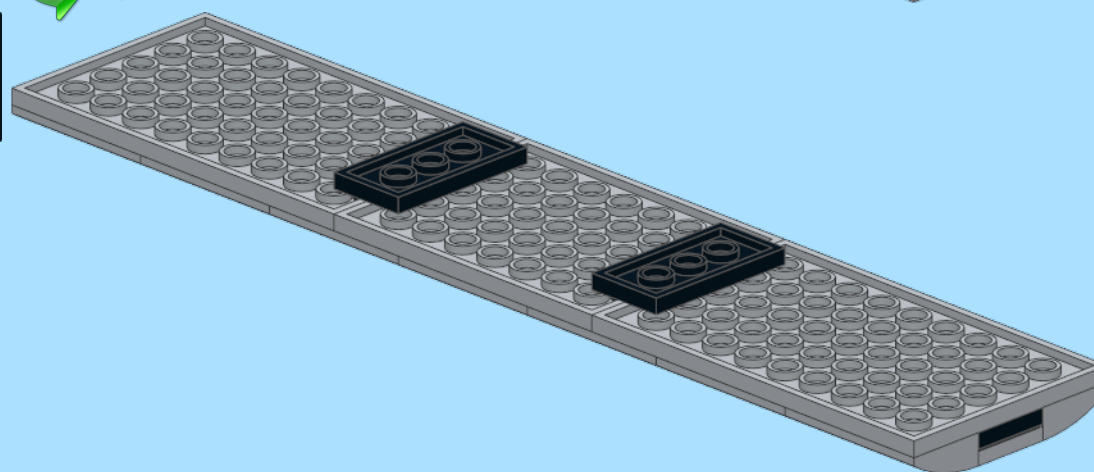
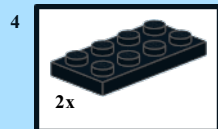
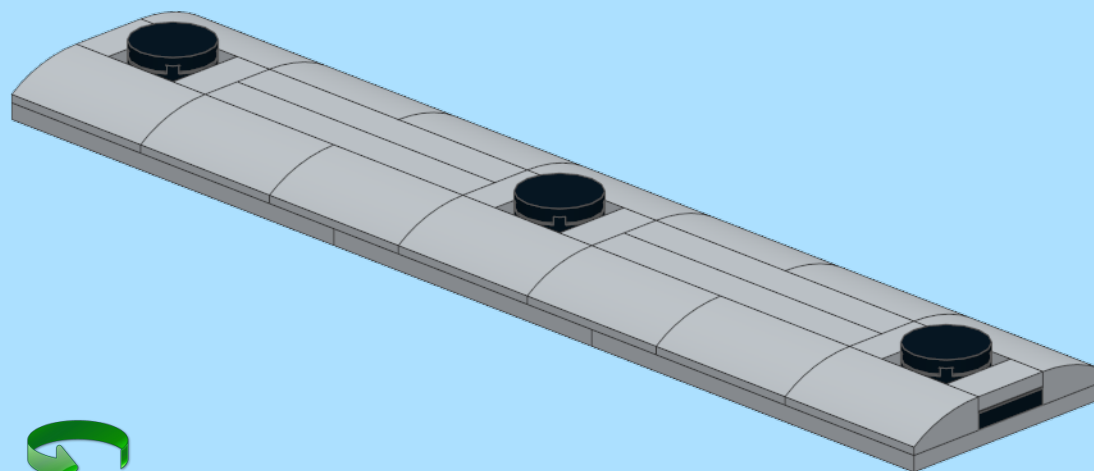
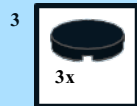

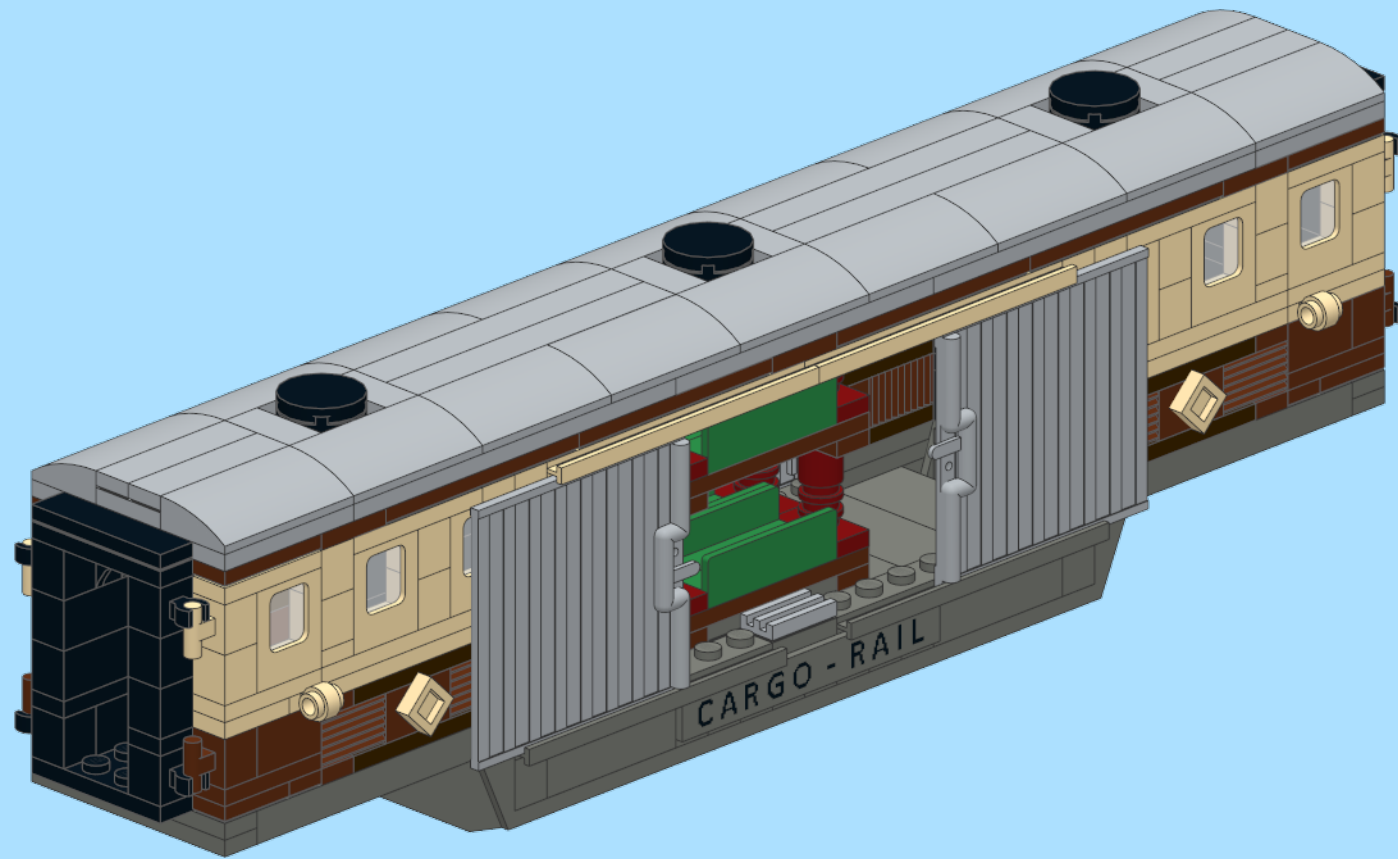



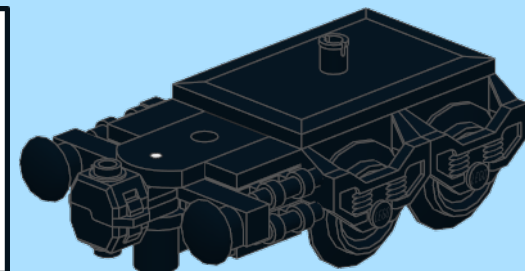
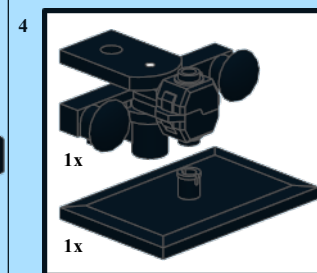
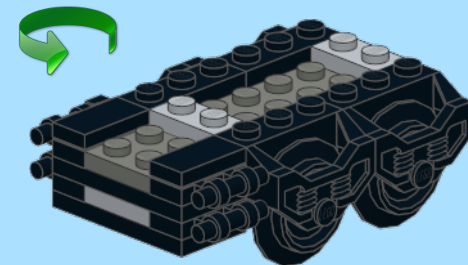
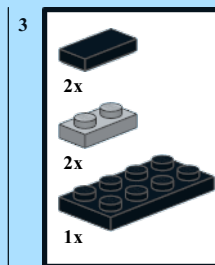
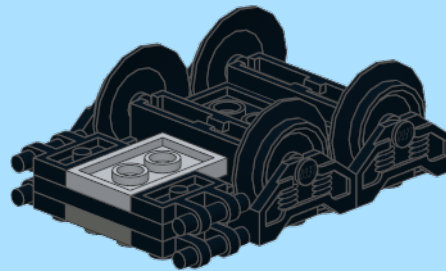
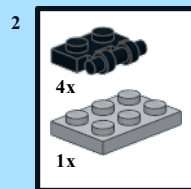
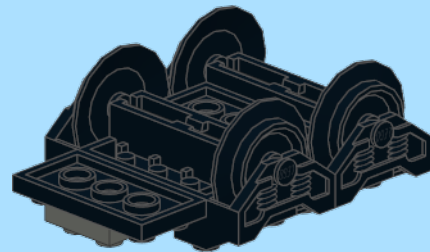
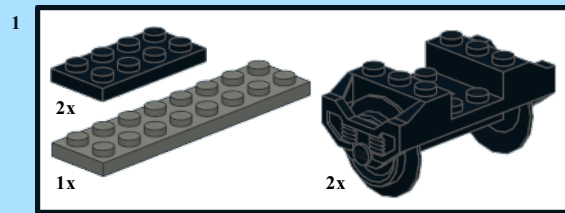

x2

