

# Emerald Night Kitchen Car



Original Design by Ben  
at <http://www.brickshelf.com/cgi-bin/gallery.cgi?f=523116>

INSTRUCTION BY  
**KNUD ALBRECHTSEN**  
[www.snakebyte.dk/lego](http://www.snakebyte.dk/lego)



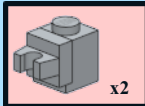

3

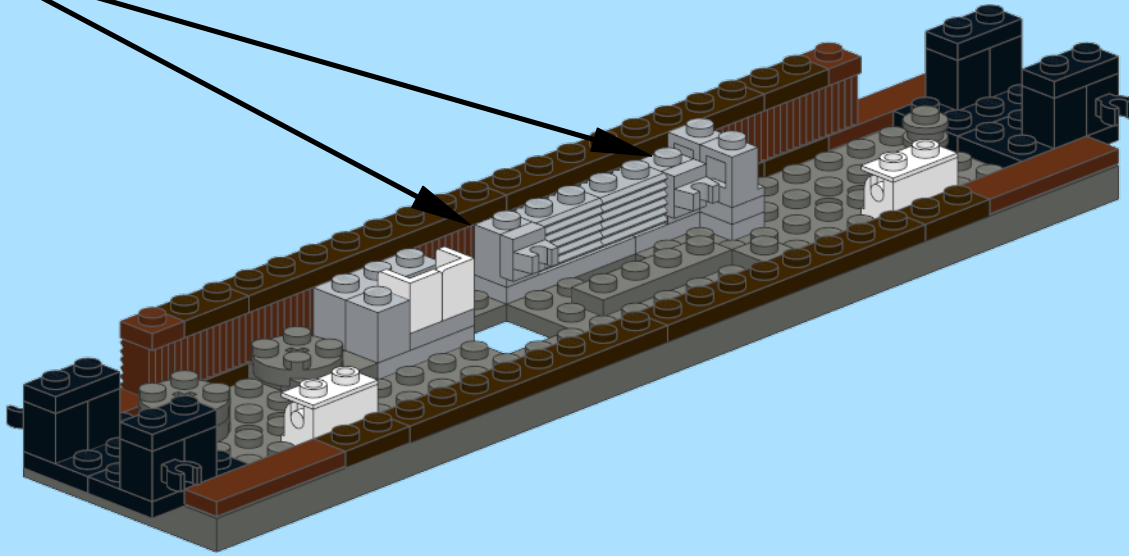
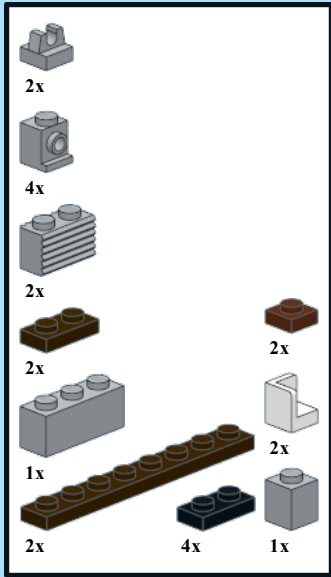



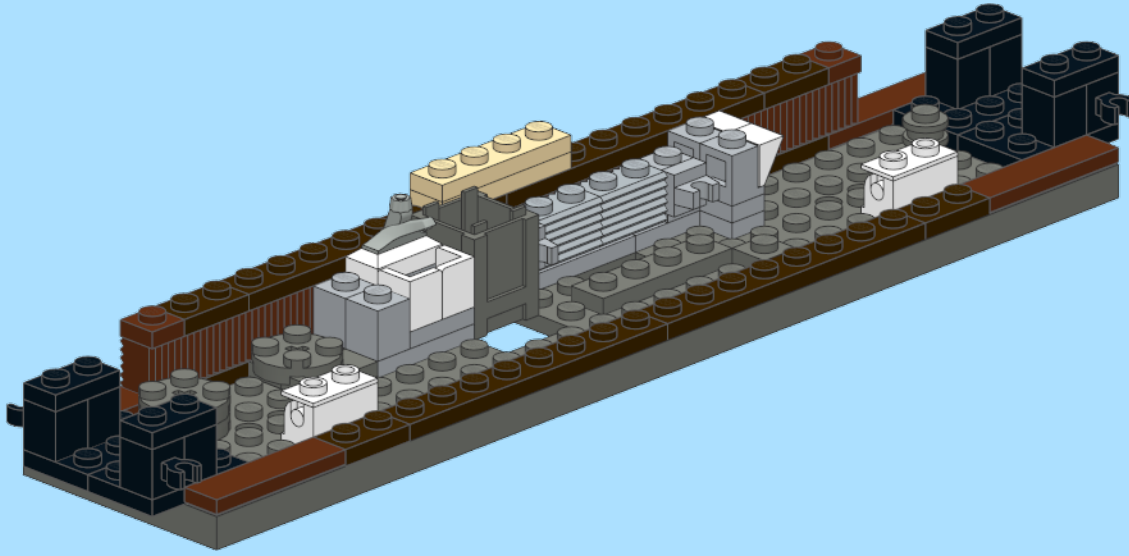
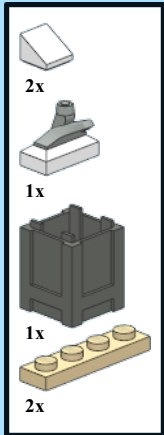

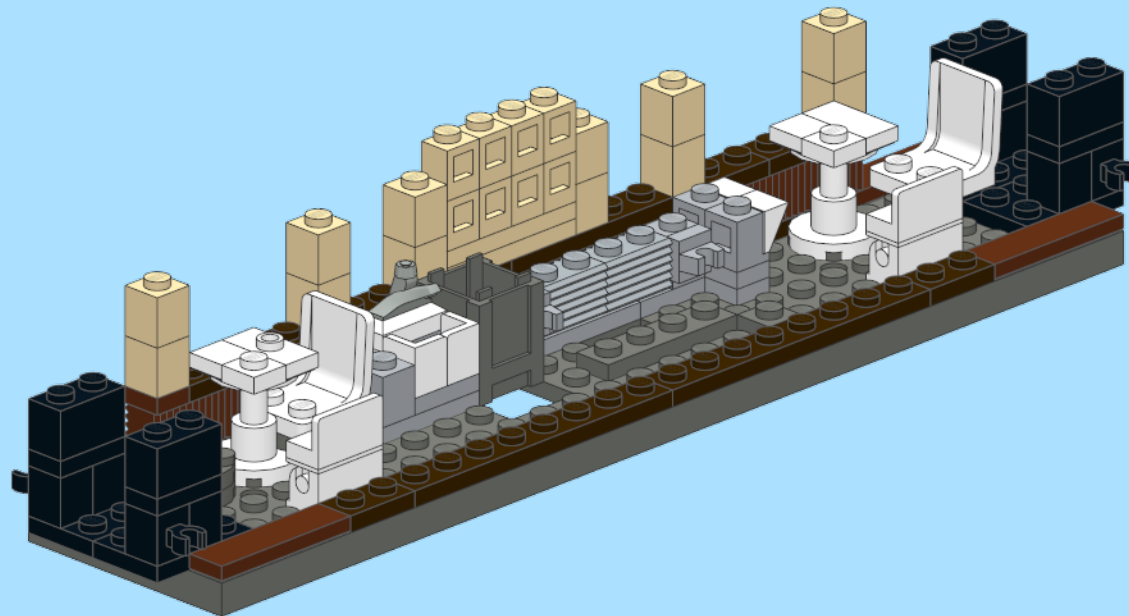
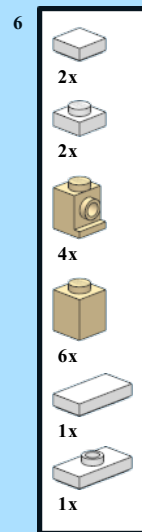
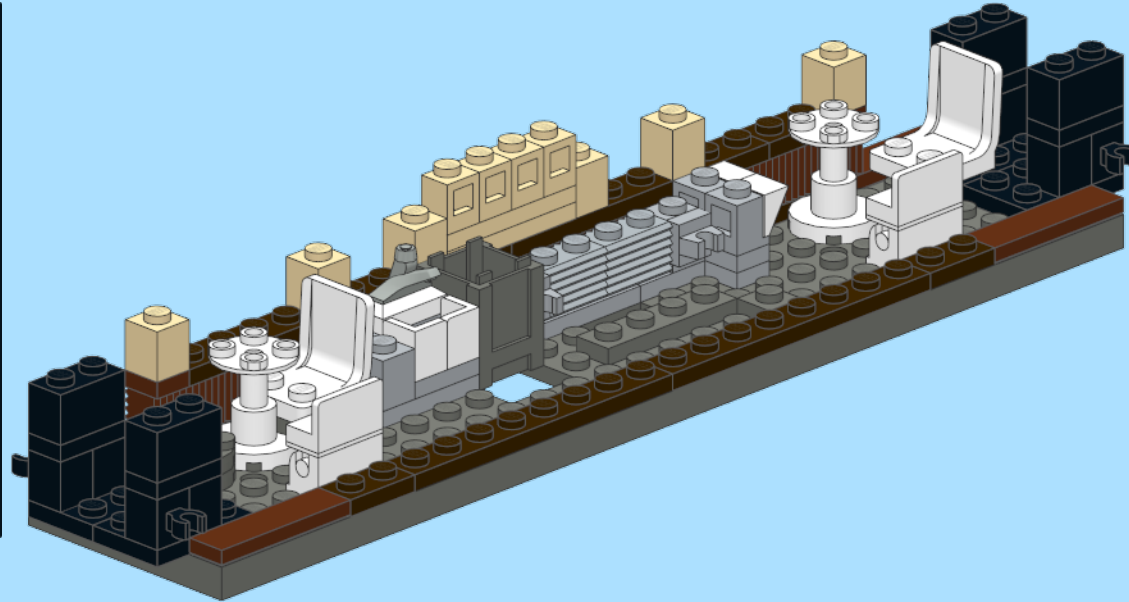
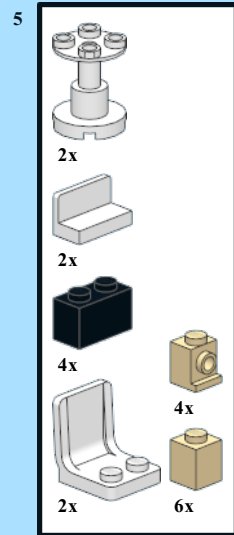





4









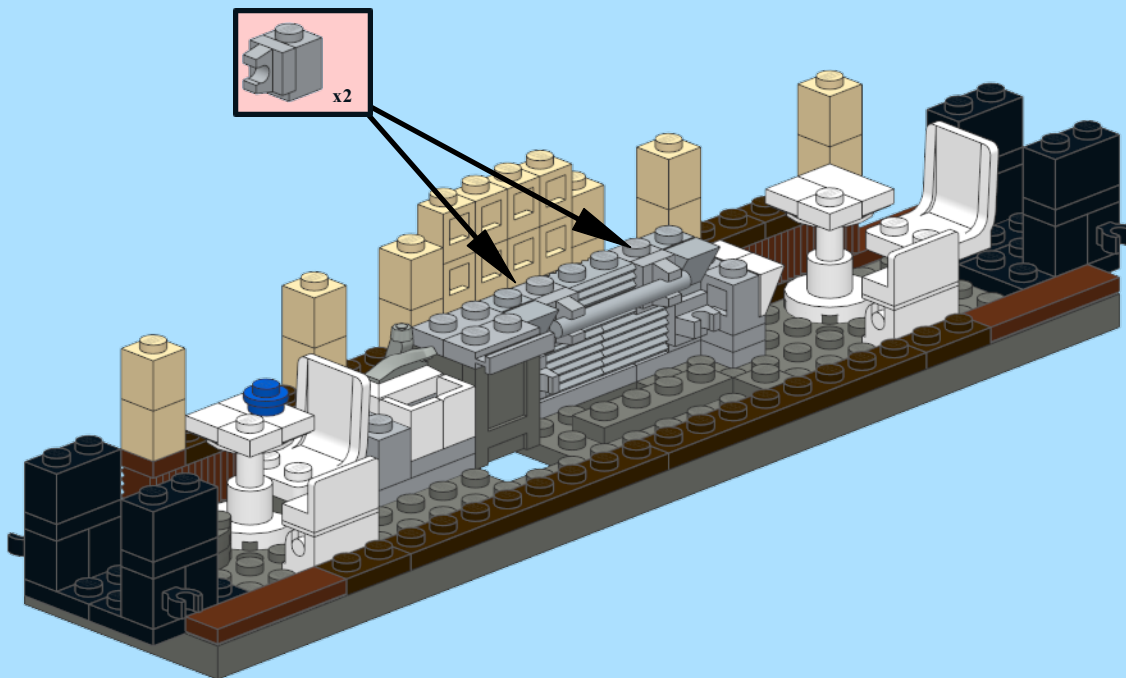







7



-  1x
-  2x
-  2x
-  2x
-  1x
-  1x
-  1x
-  1x
-  1x
-  2x

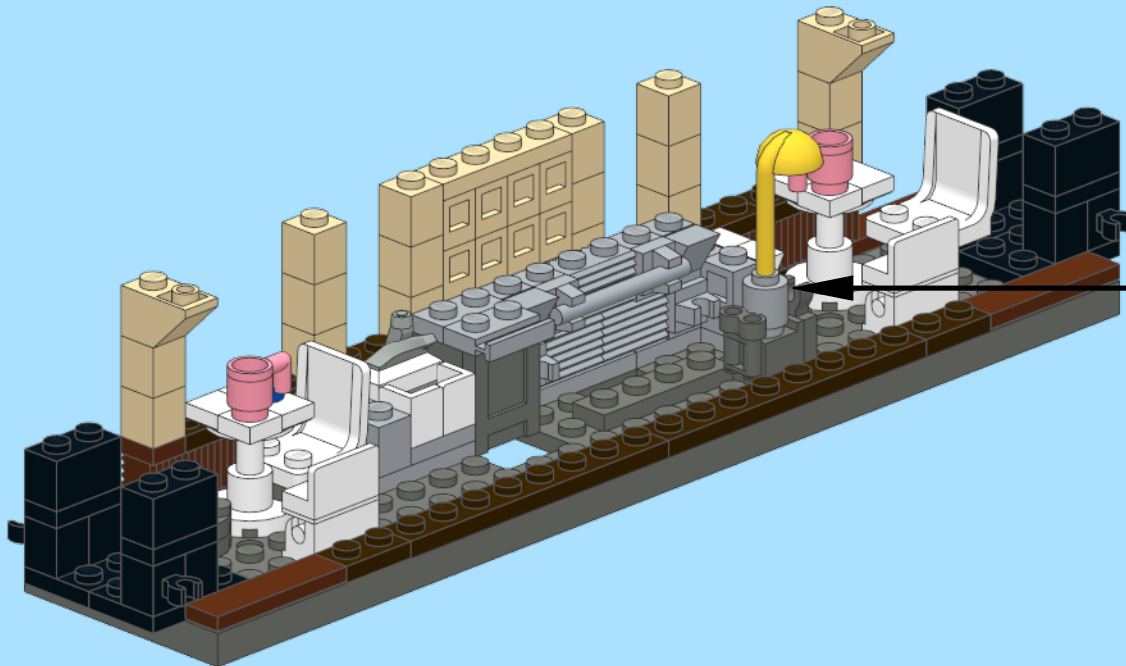

8

-  1x
-  1x
-  1x
-  1x
-  2x
-  1x
-  1x
-  1x
-  1x
-  2x
-  2x
-  4x



- 1 
- 2 





11

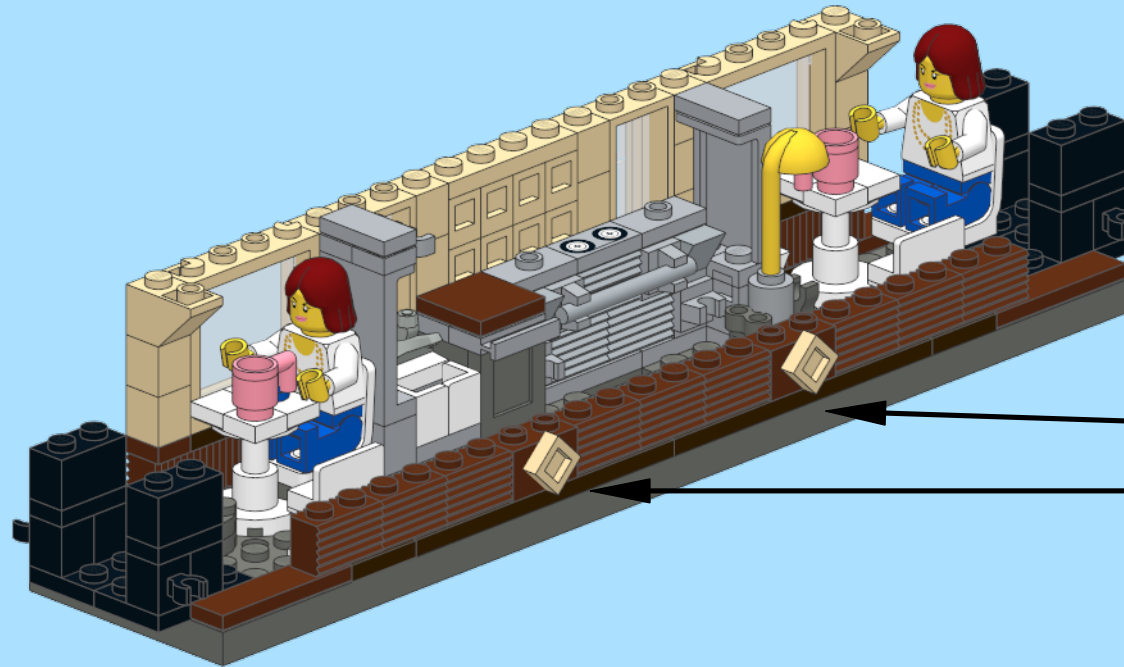
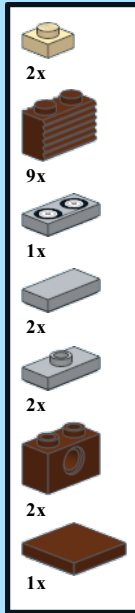

12

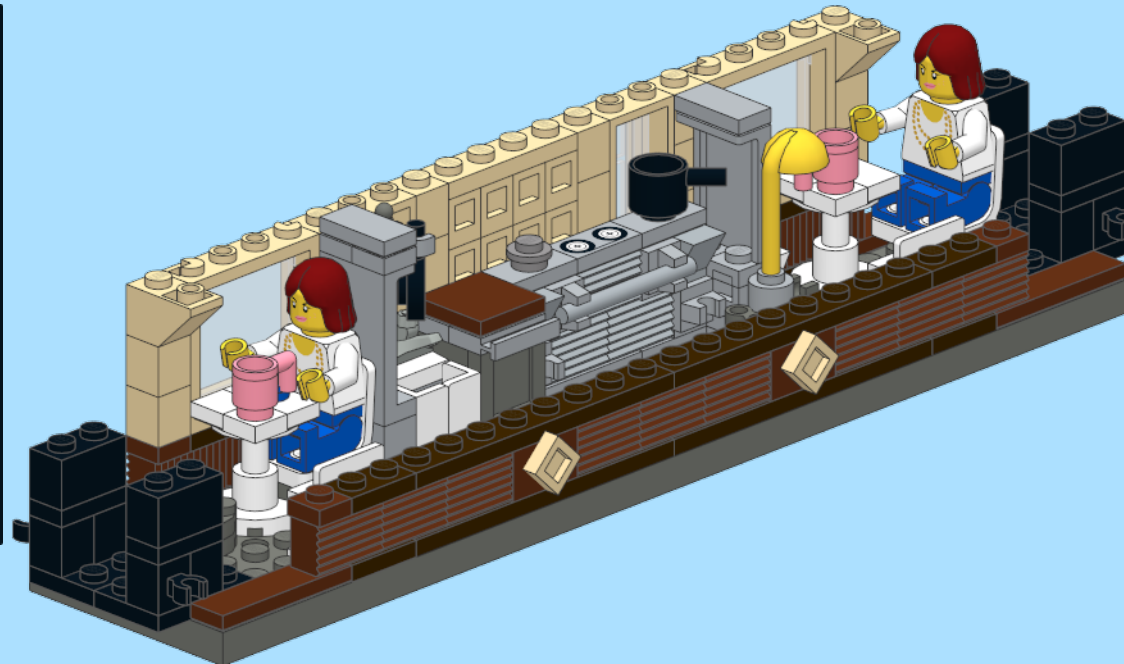

13

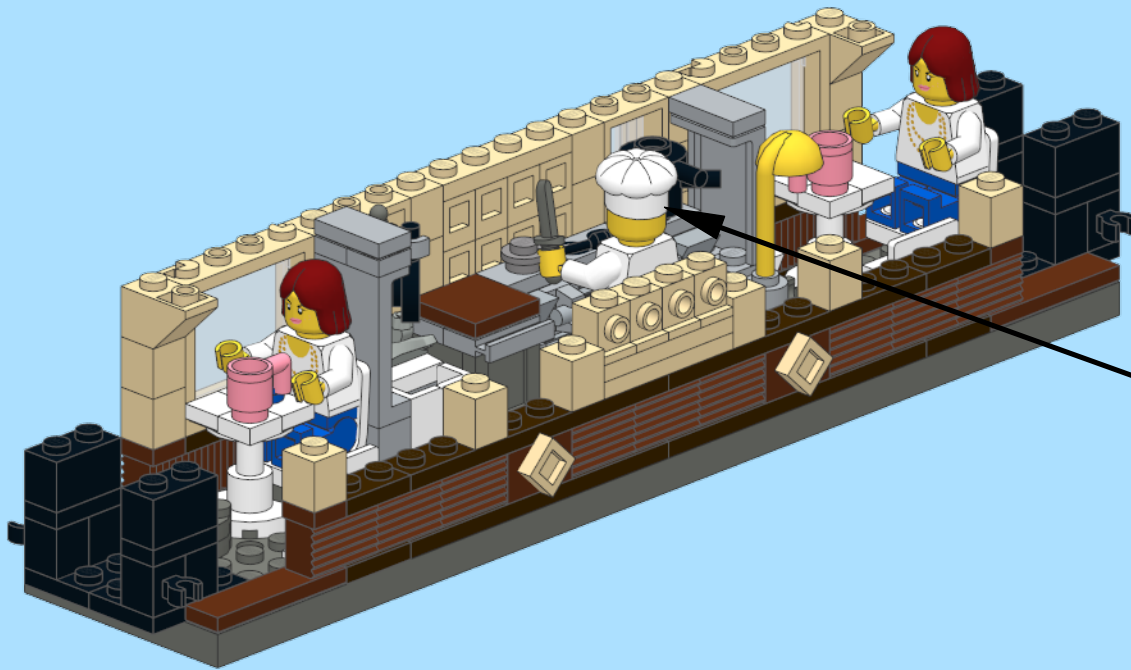
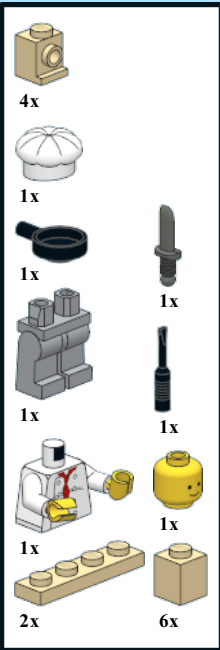

14

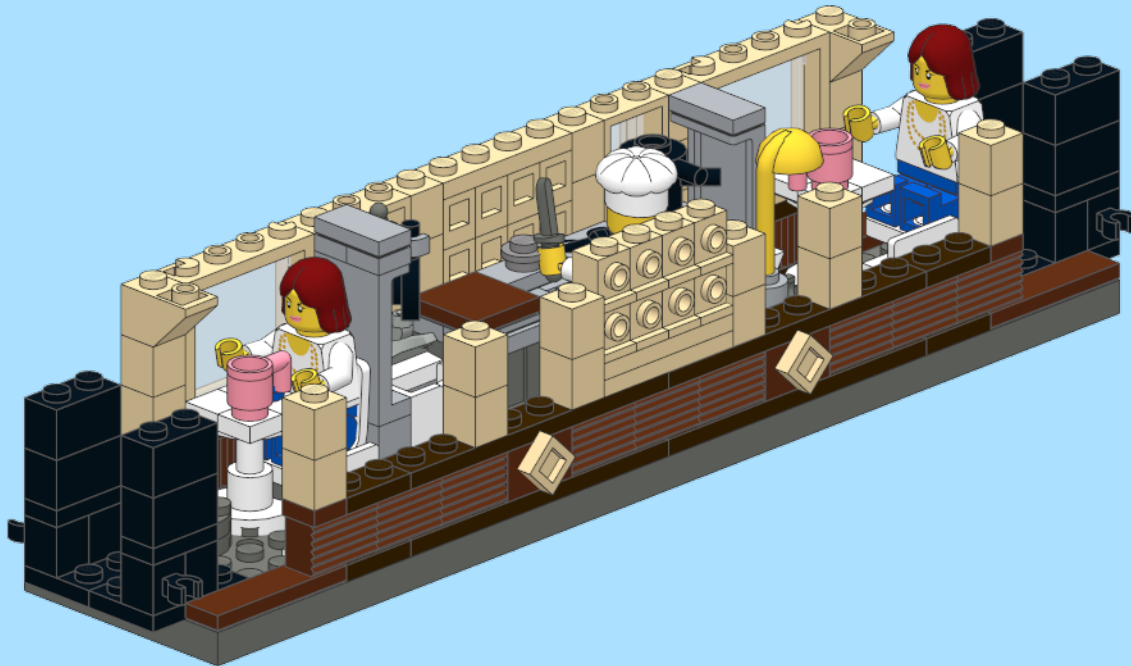



15

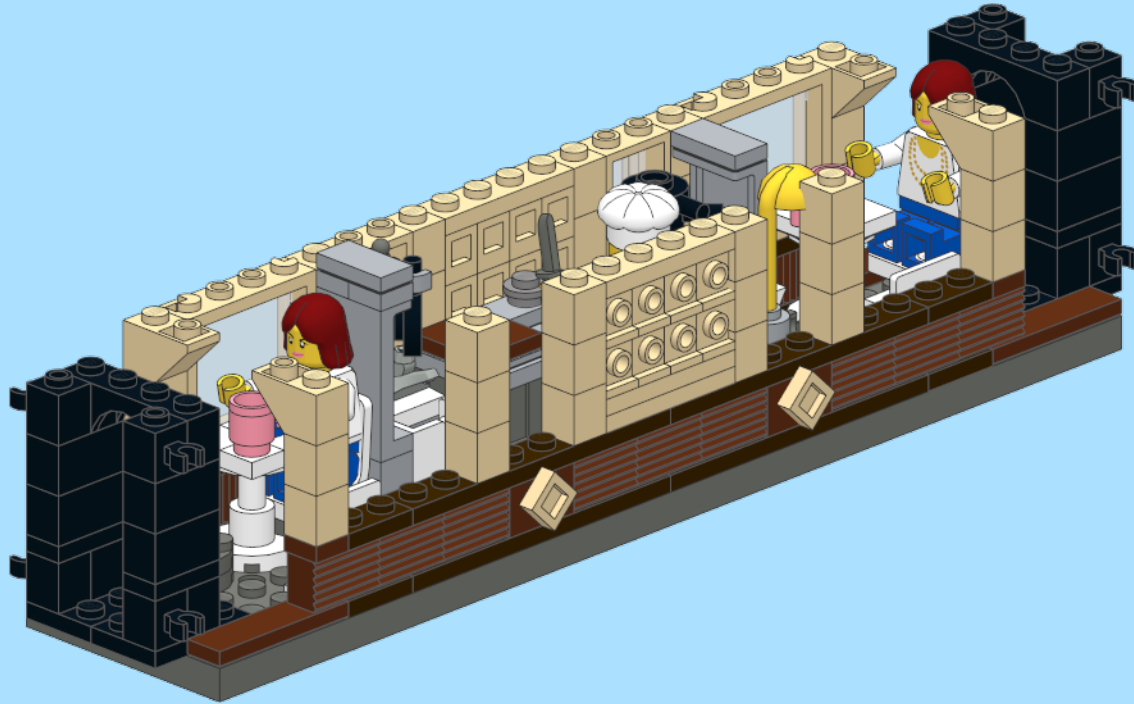
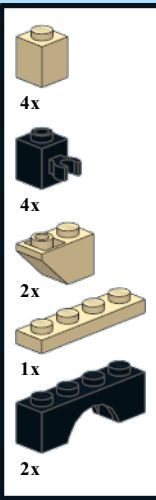

16

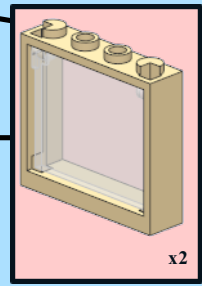
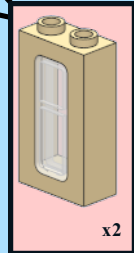
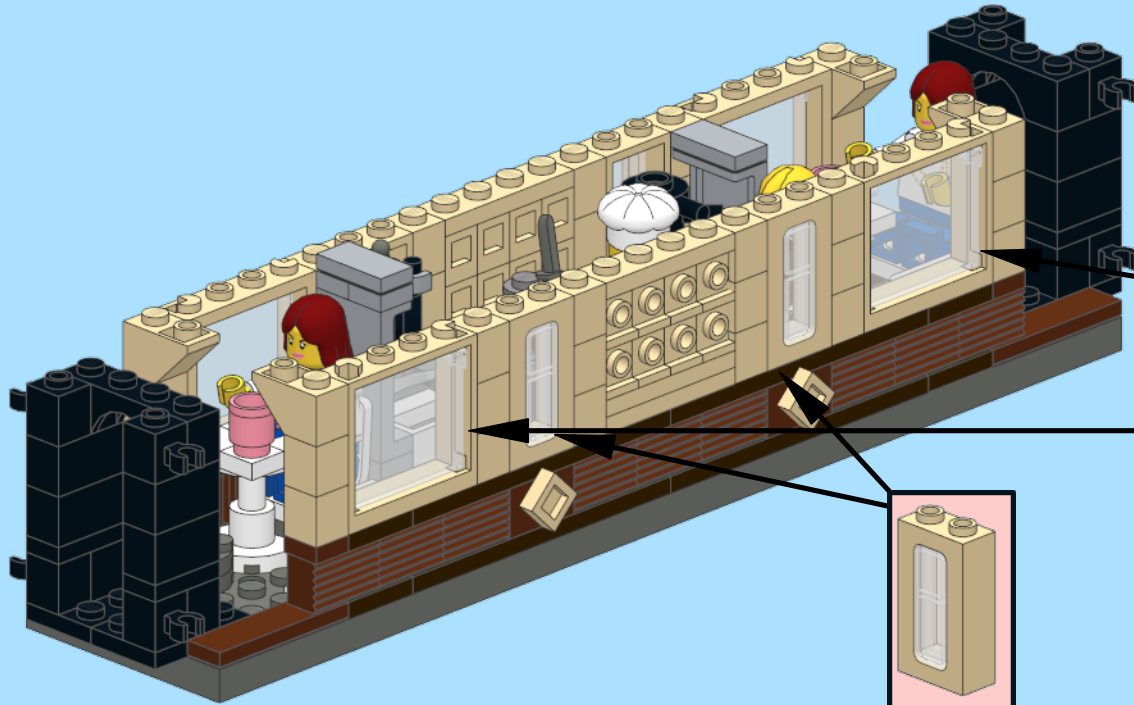
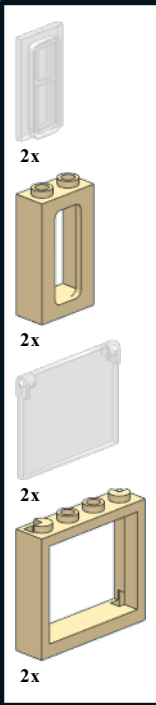

17

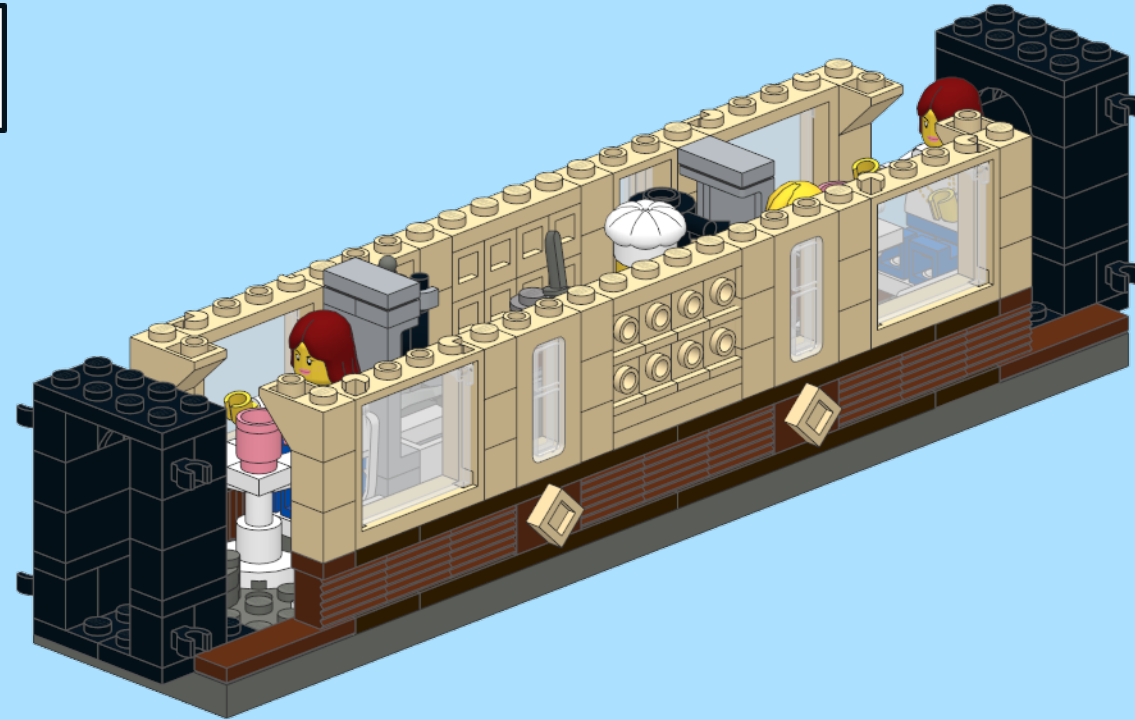
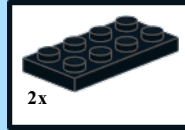

18

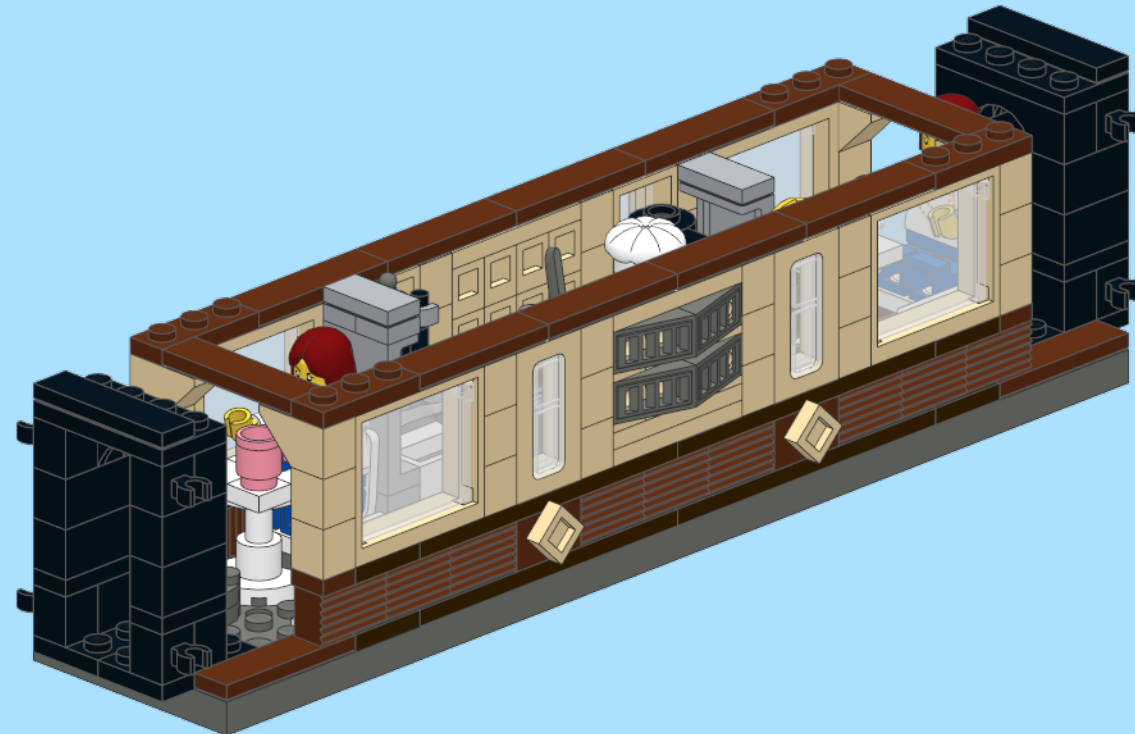
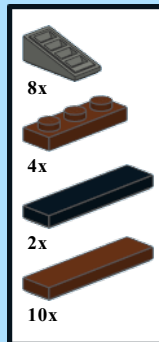



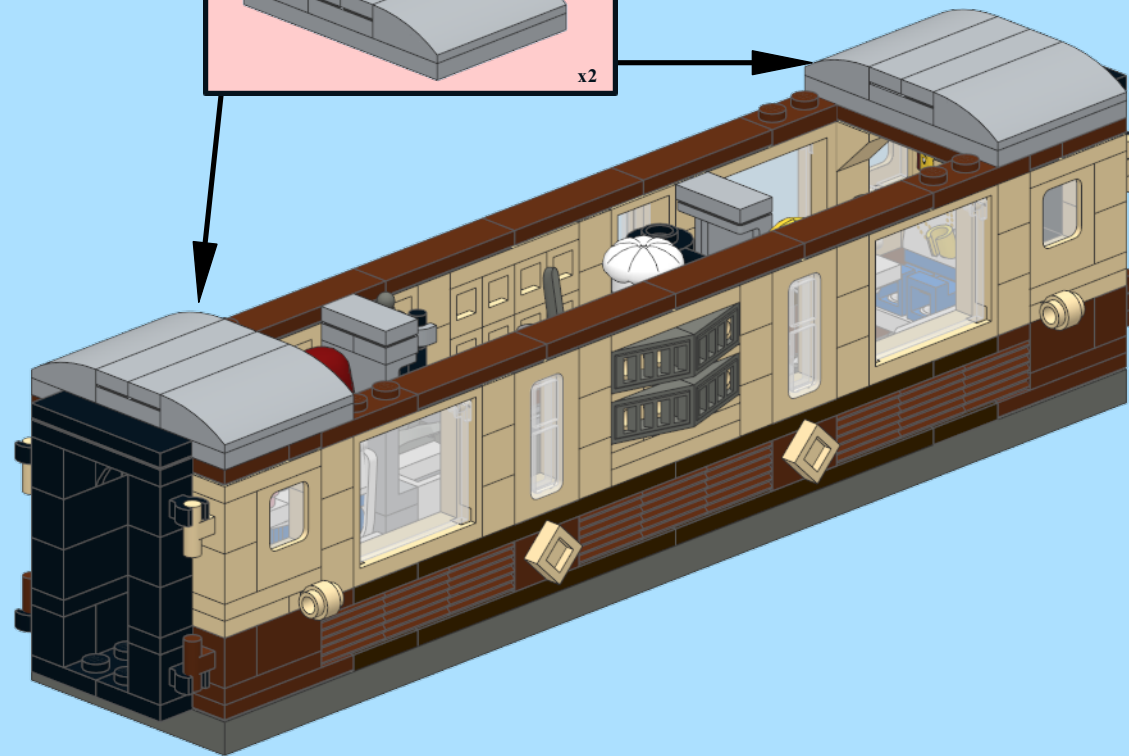
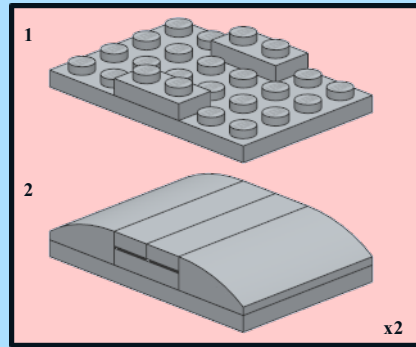
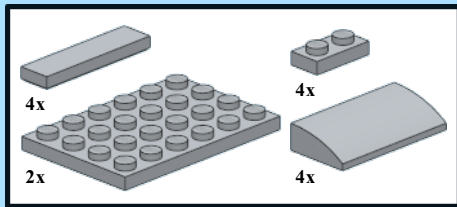



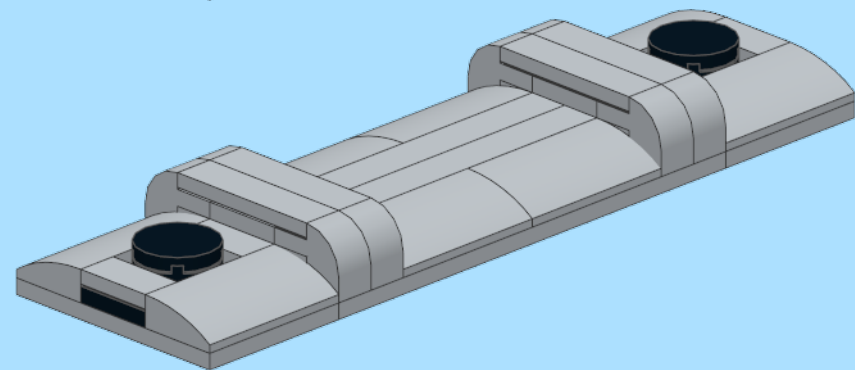
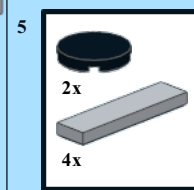
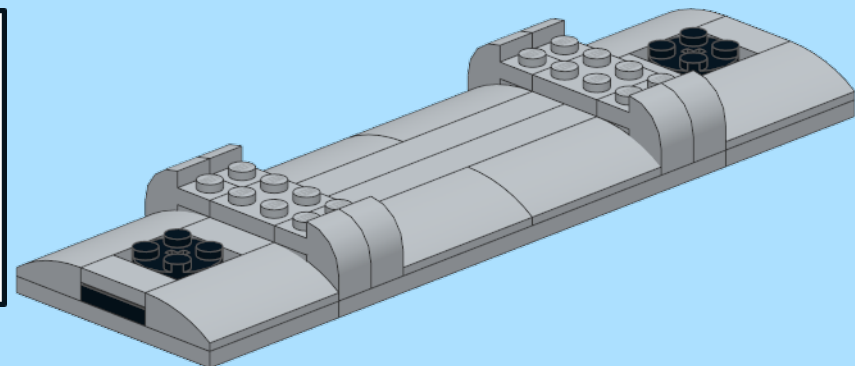
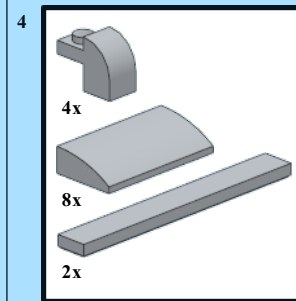
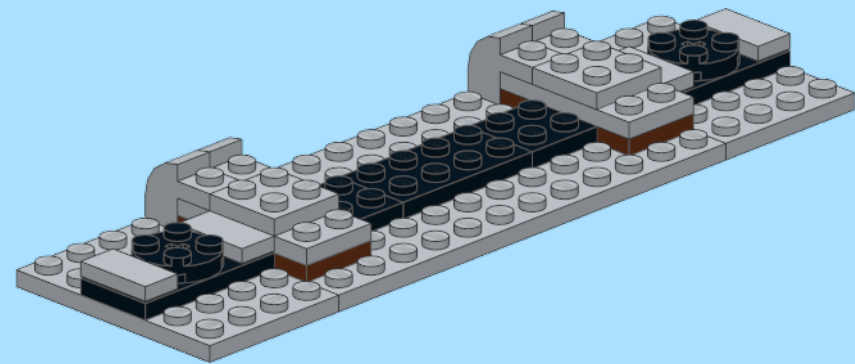
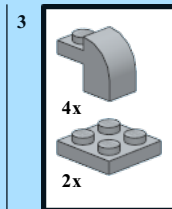
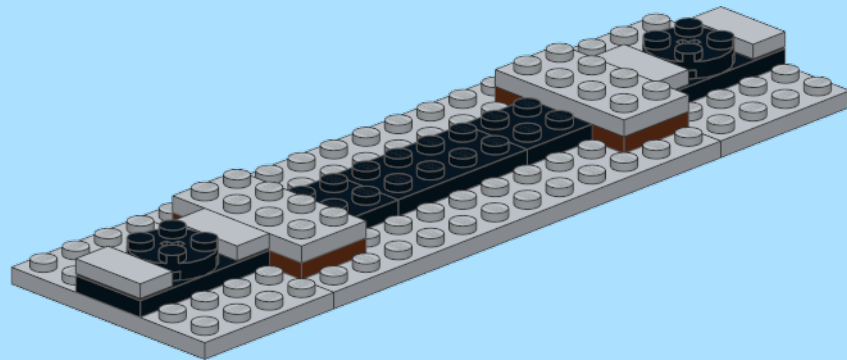
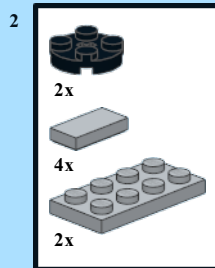
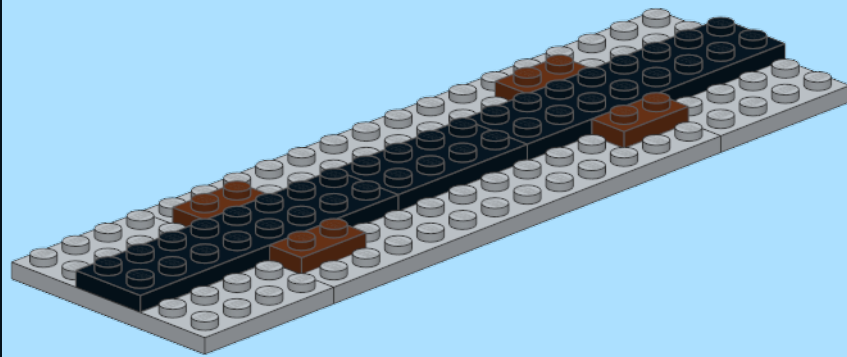
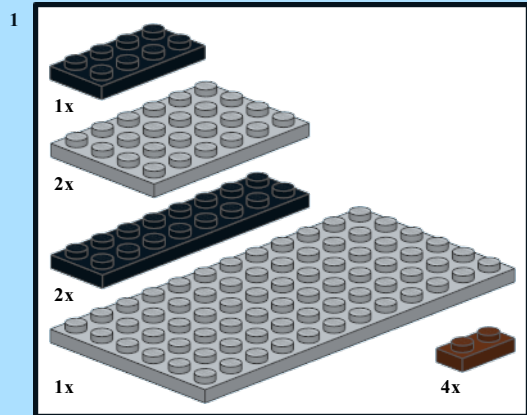

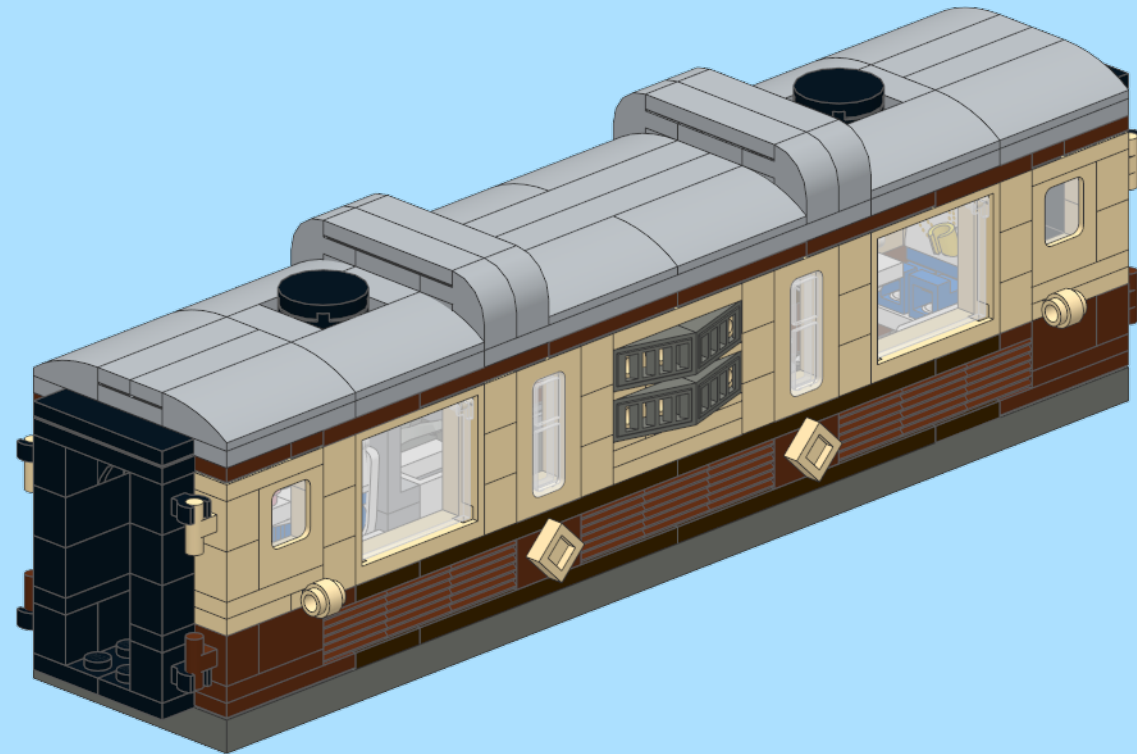

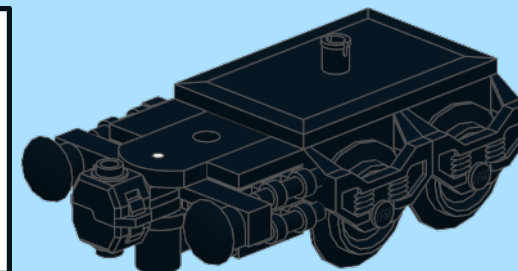
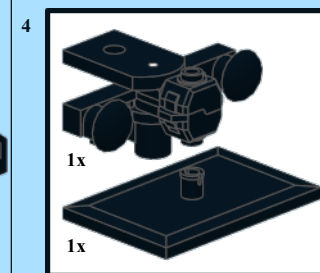
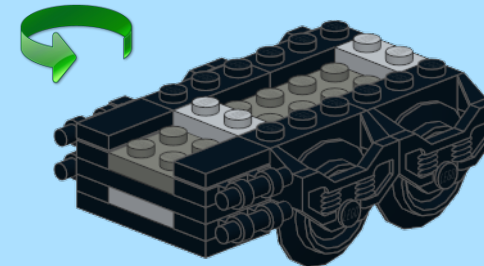
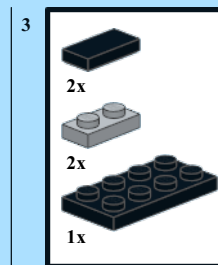
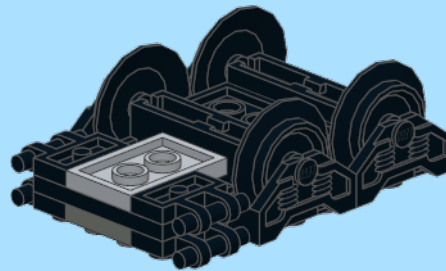
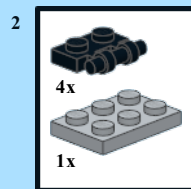
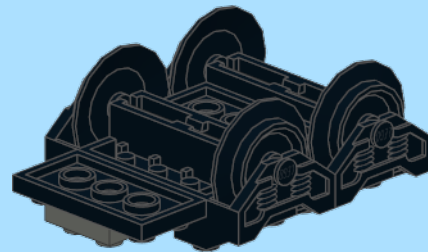
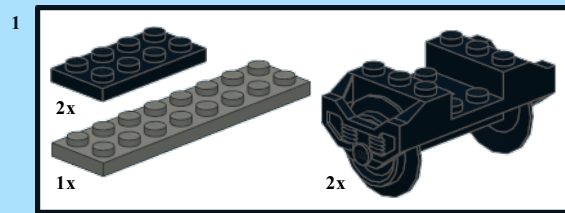

x2







