

Emerald Night Sleeping Car

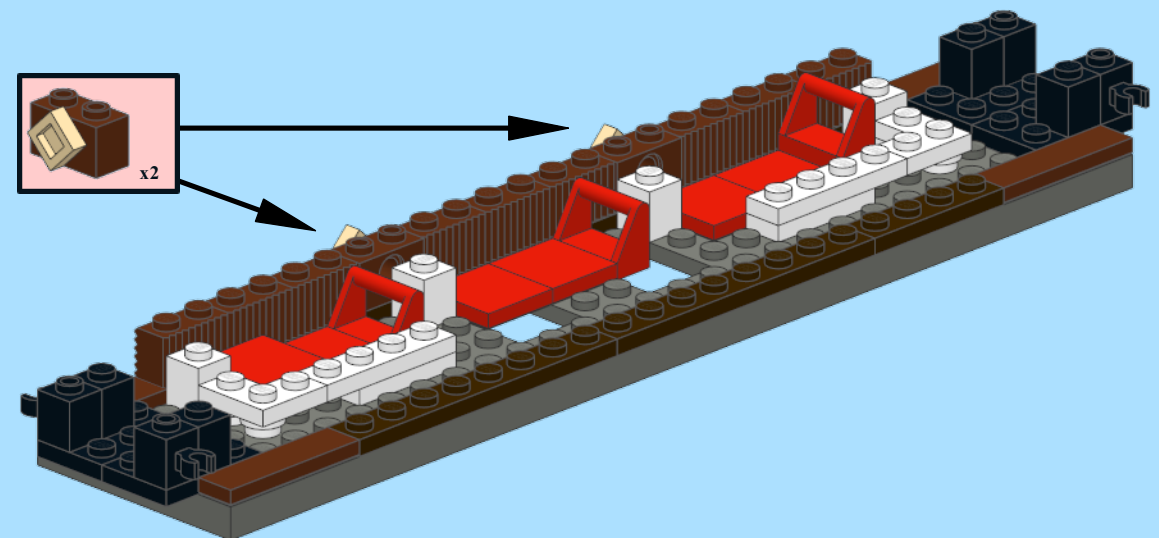

Original Design By Ben Beneke

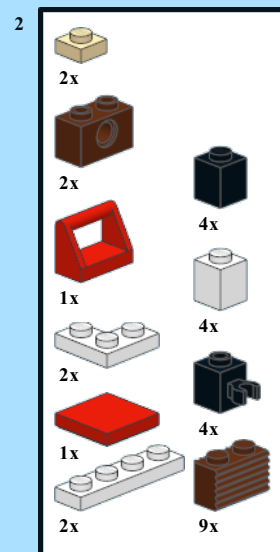

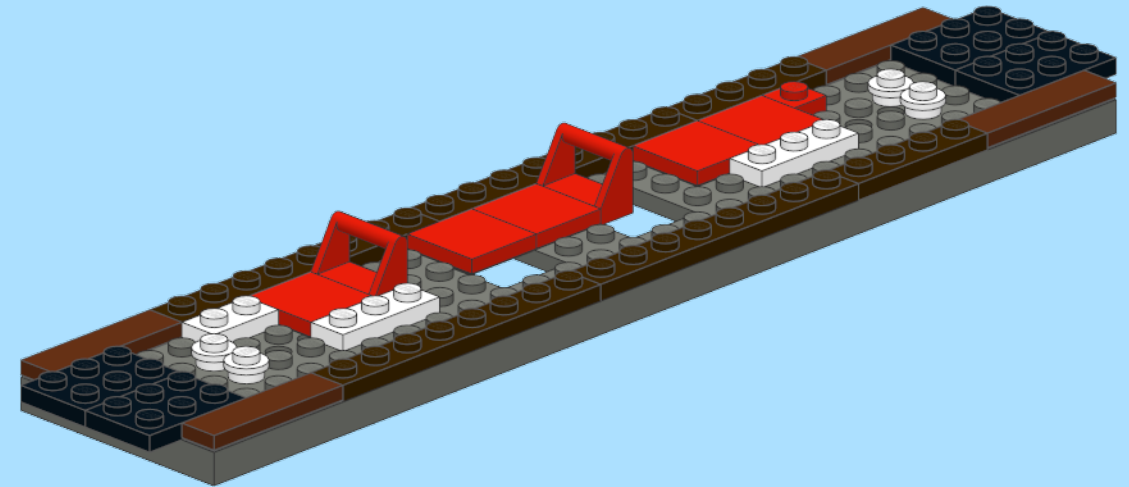
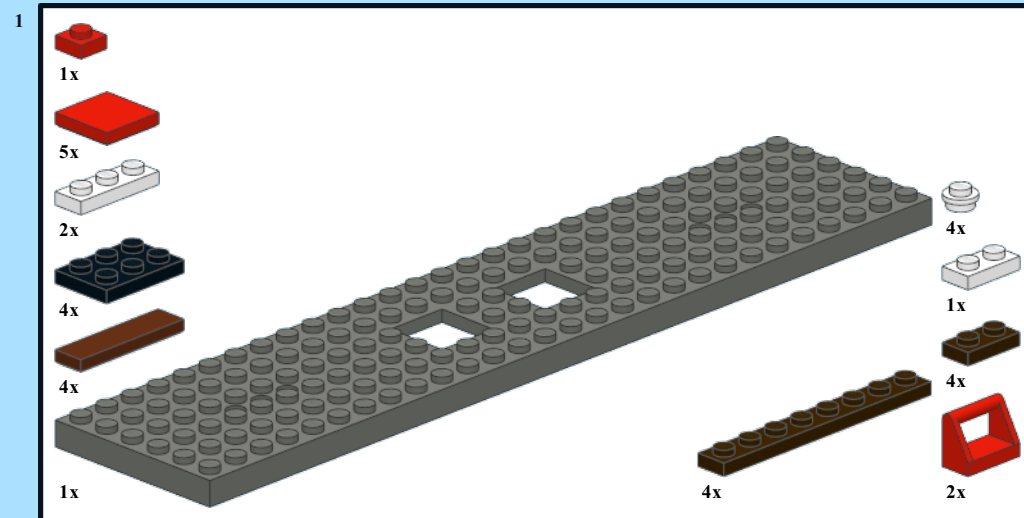

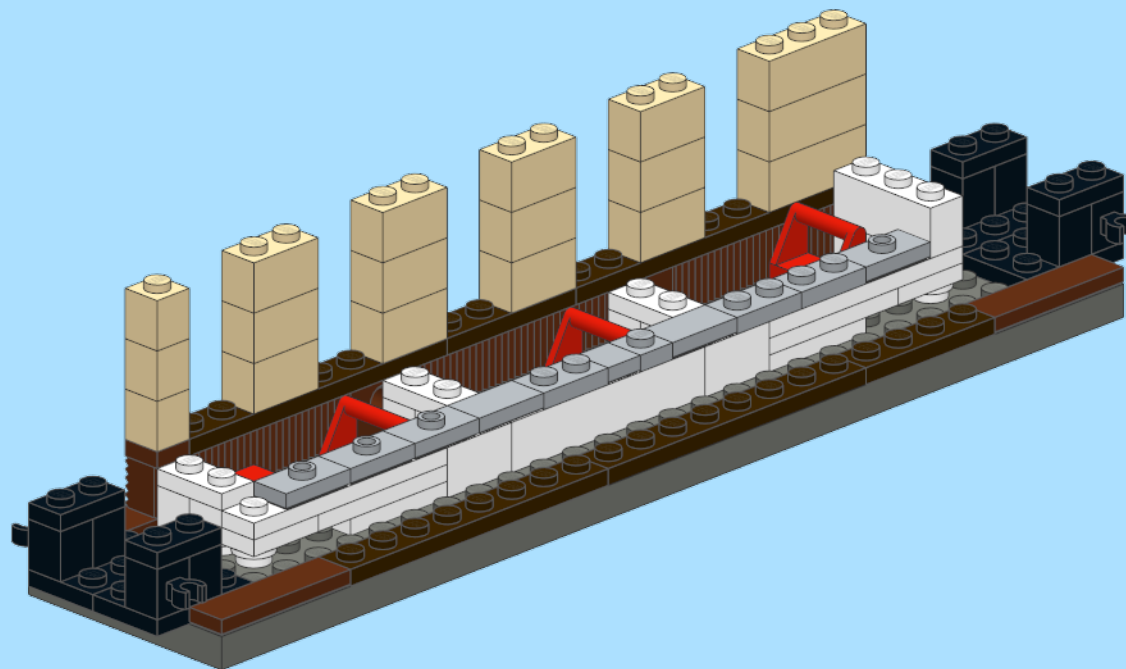
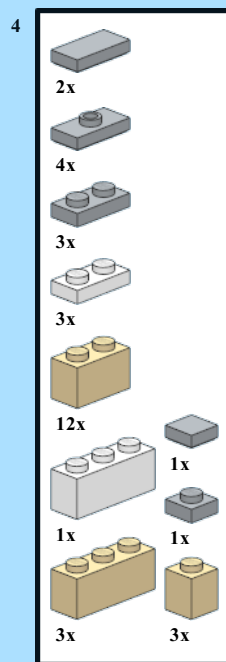
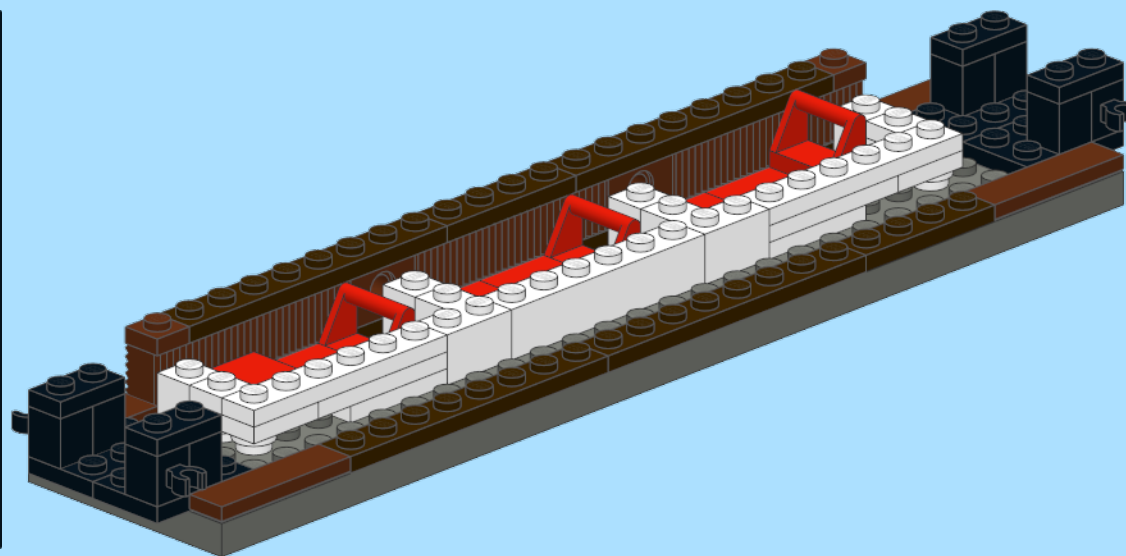
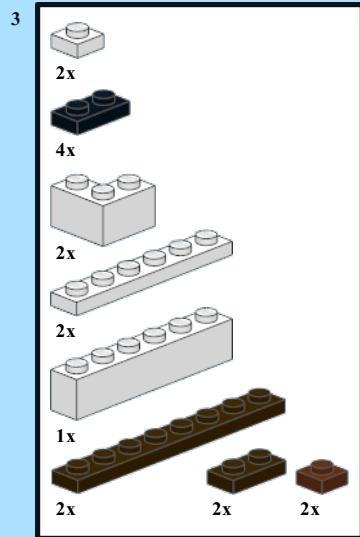
INSTRUCTION BY
KNUD ALBRECHTSEN
www.snakebyte.dk/lego

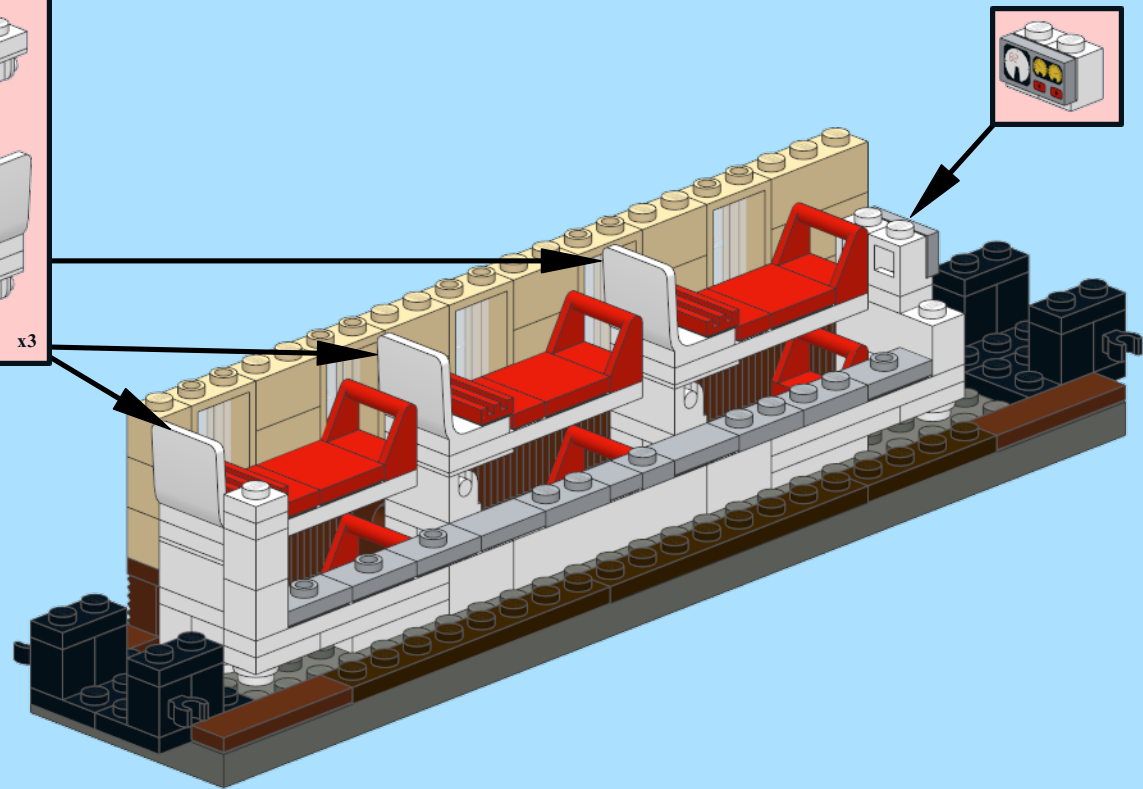
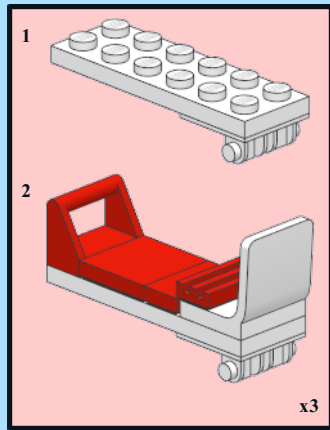
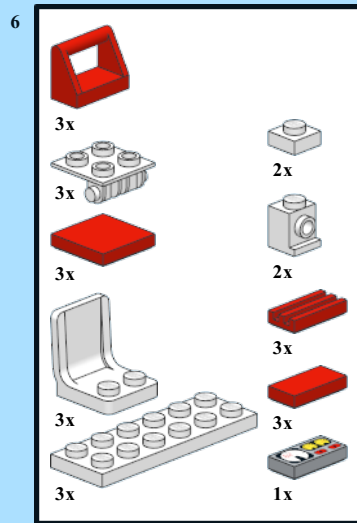
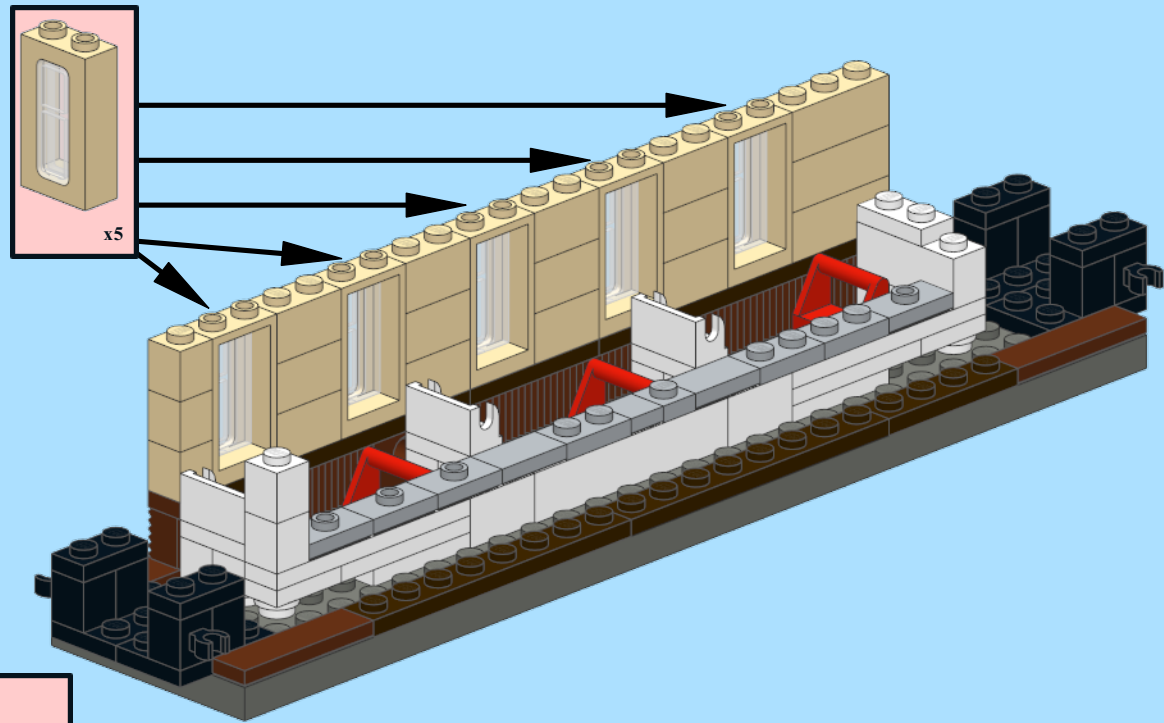
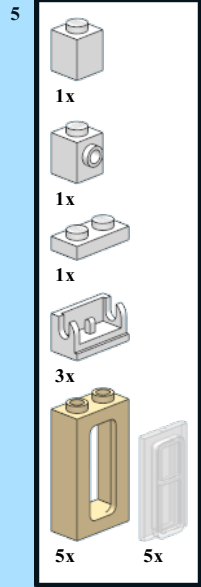









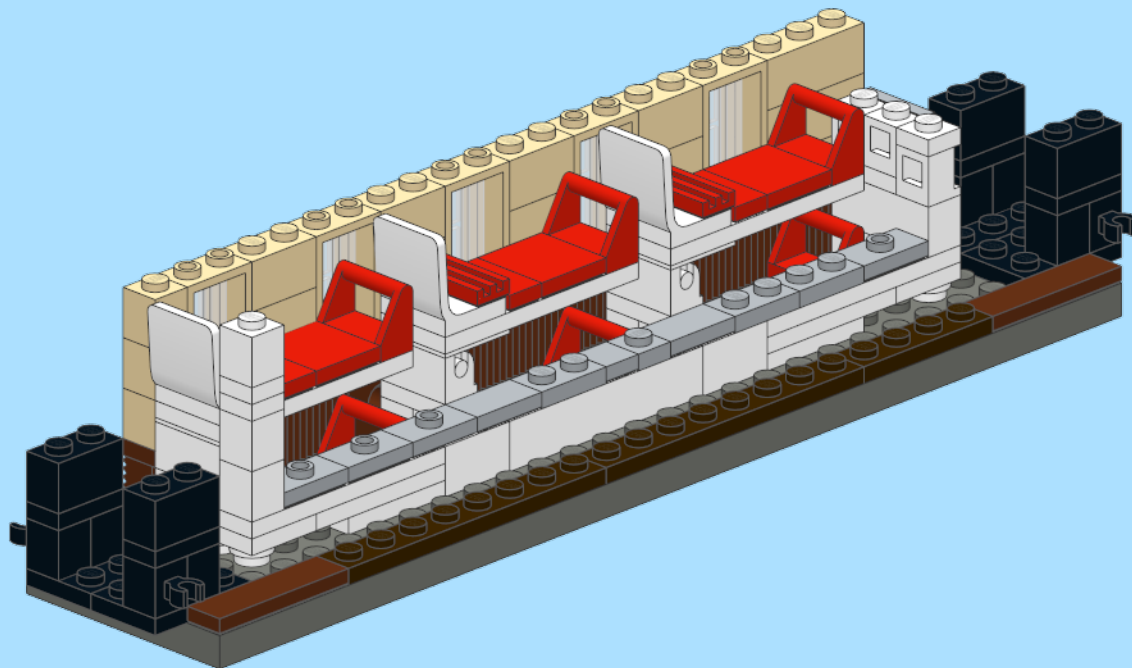

7

-  1x
-  1x
-  1x
-  4x



8

-  1x
-  2x
-  1x
-  1x
-  1x

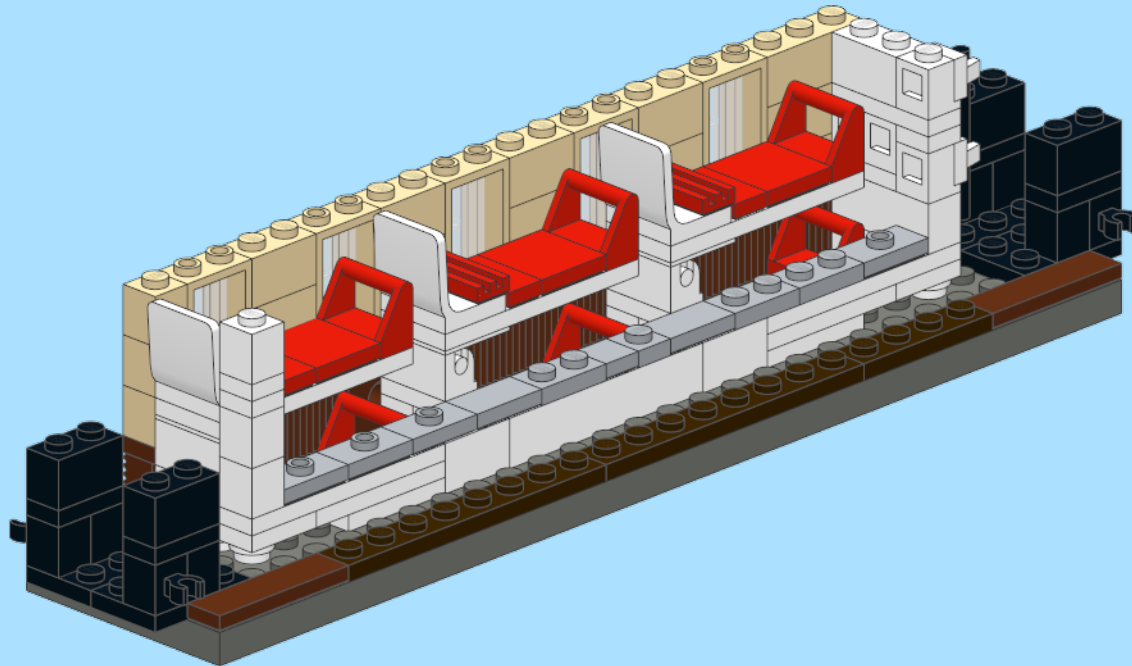

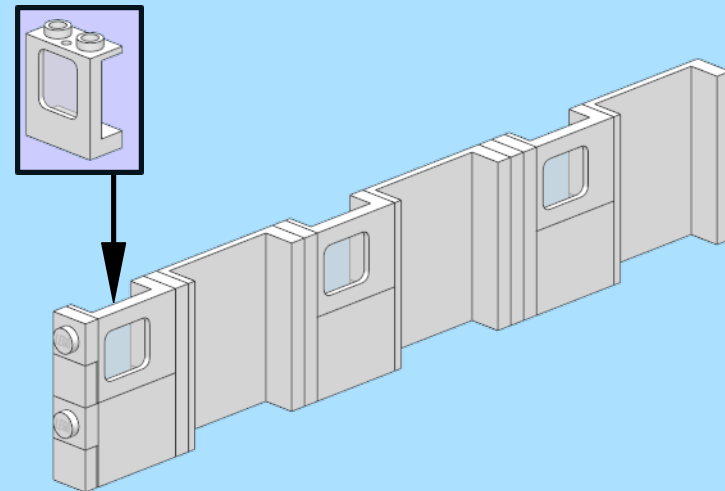
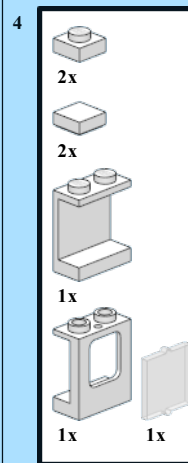
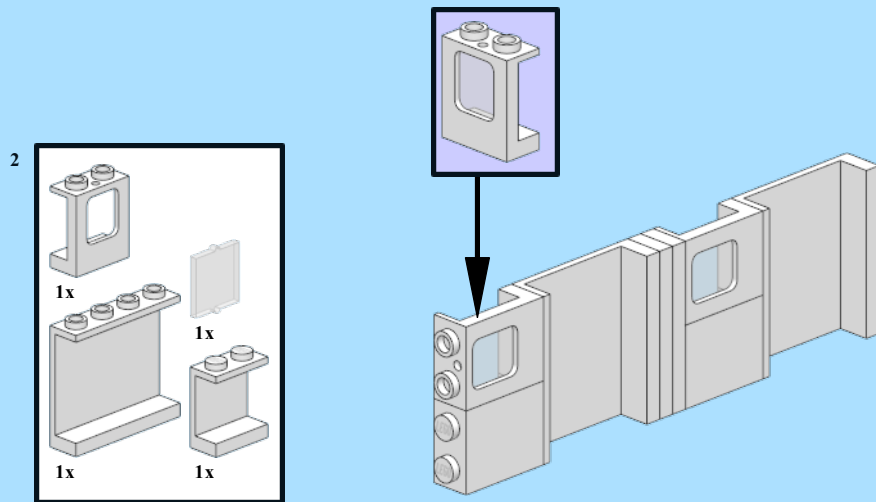
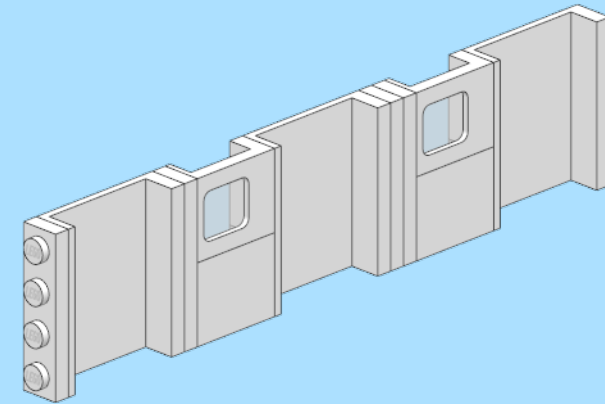
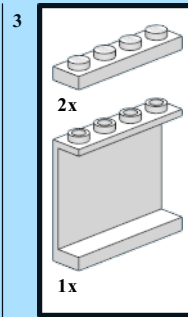
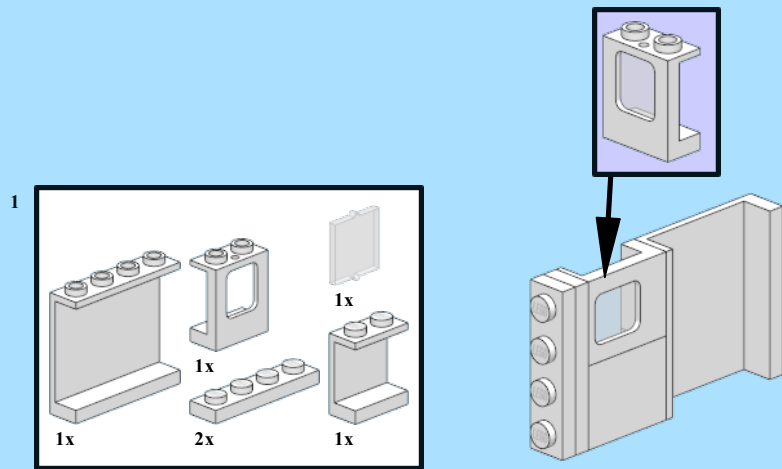

9

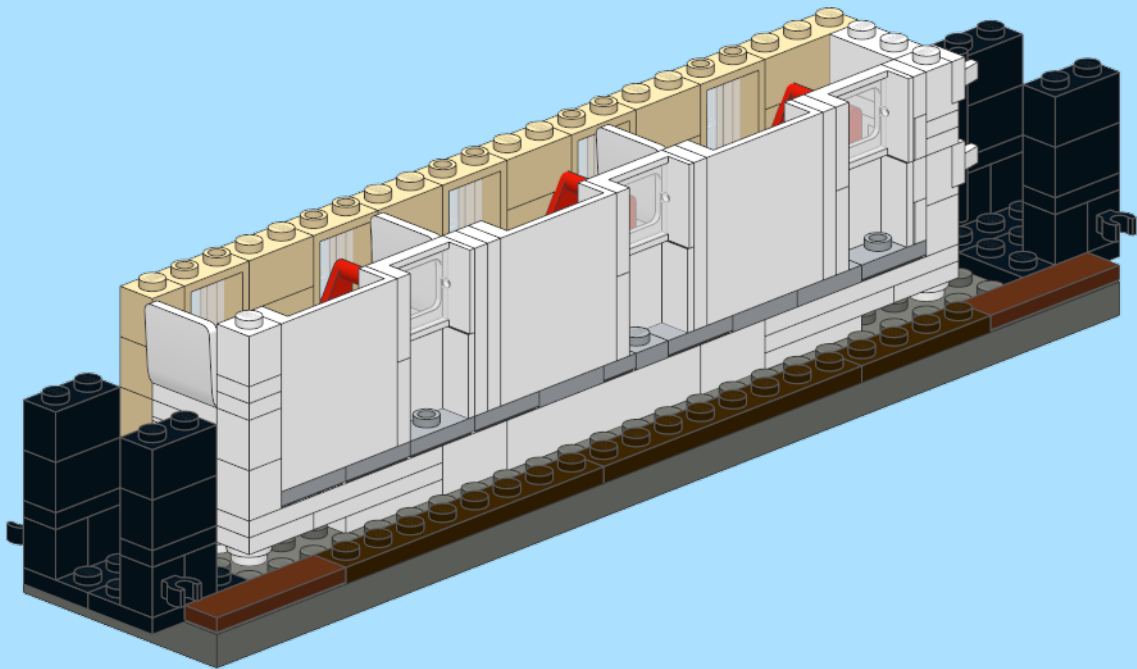

10

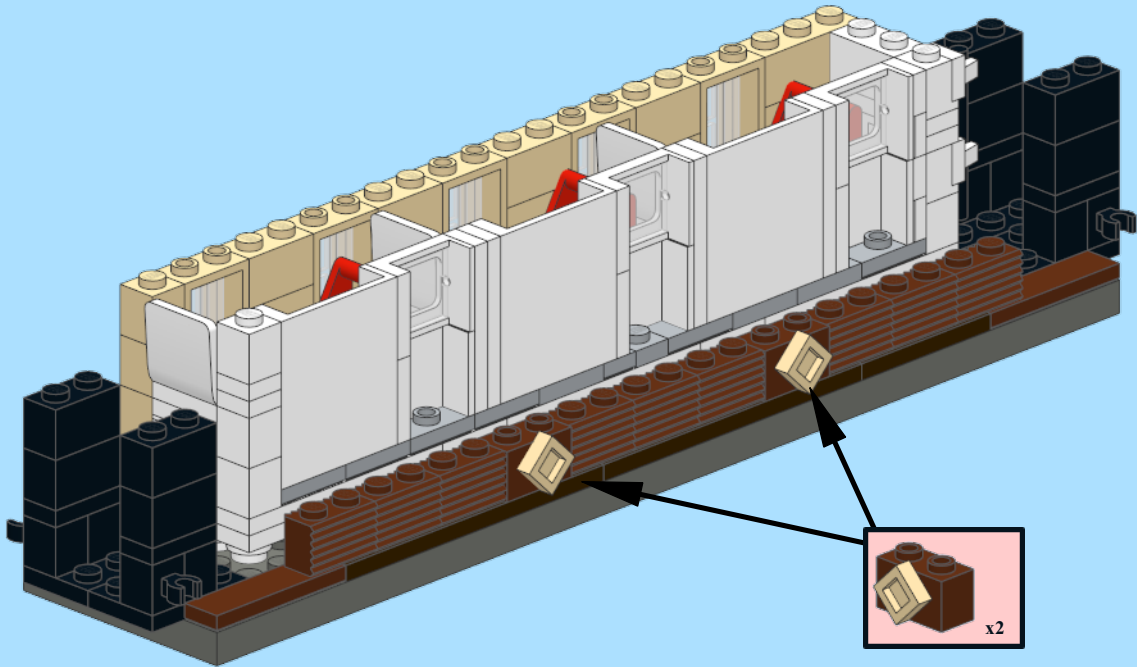
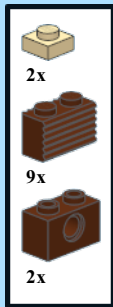

11

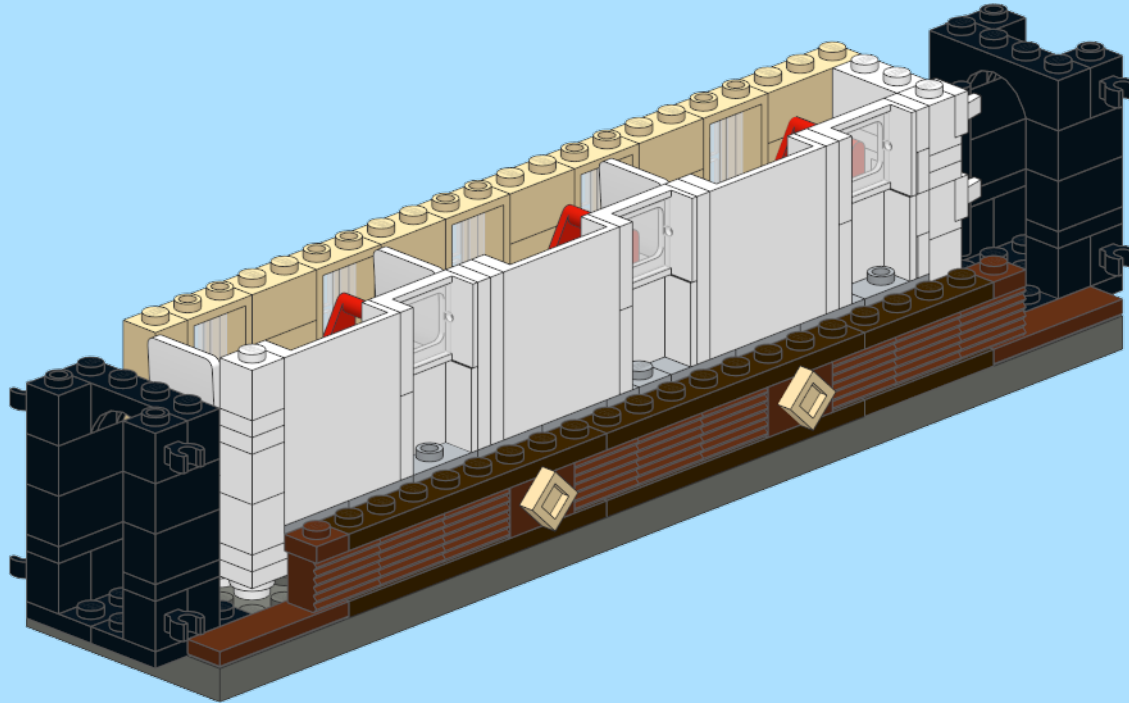
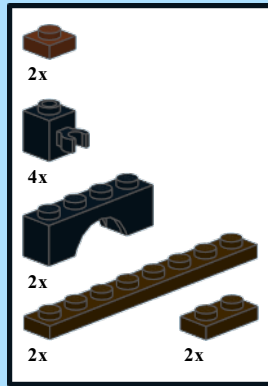

12

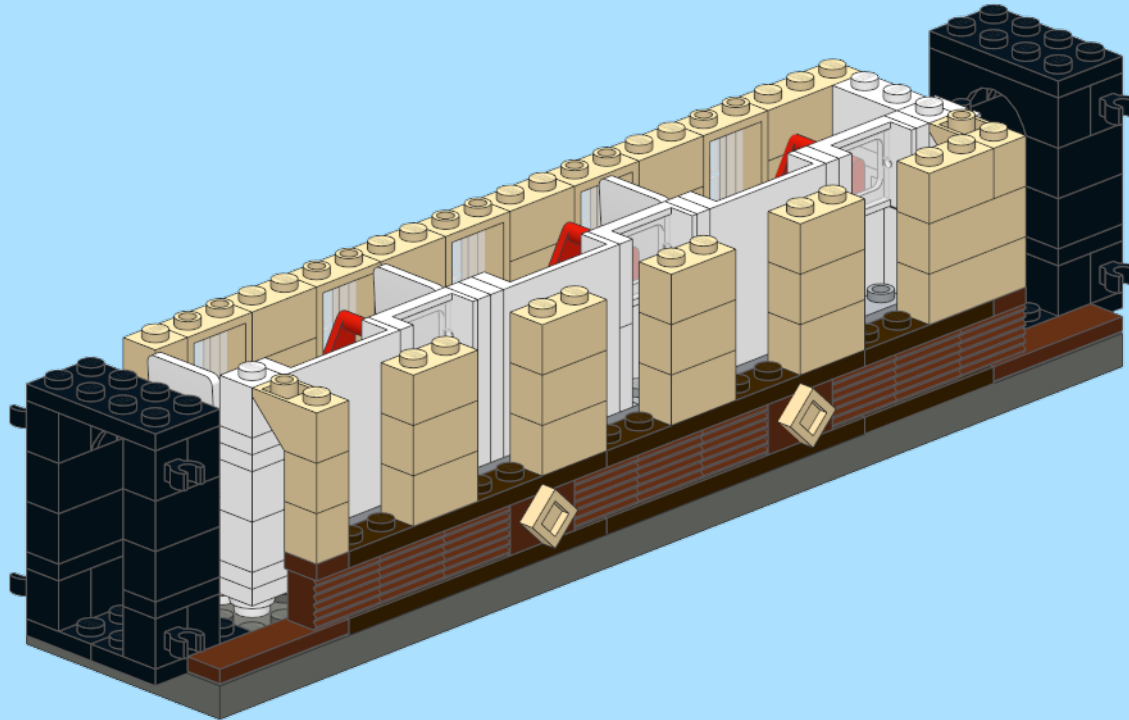
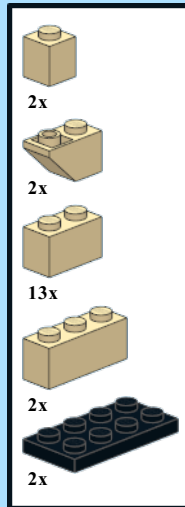

13

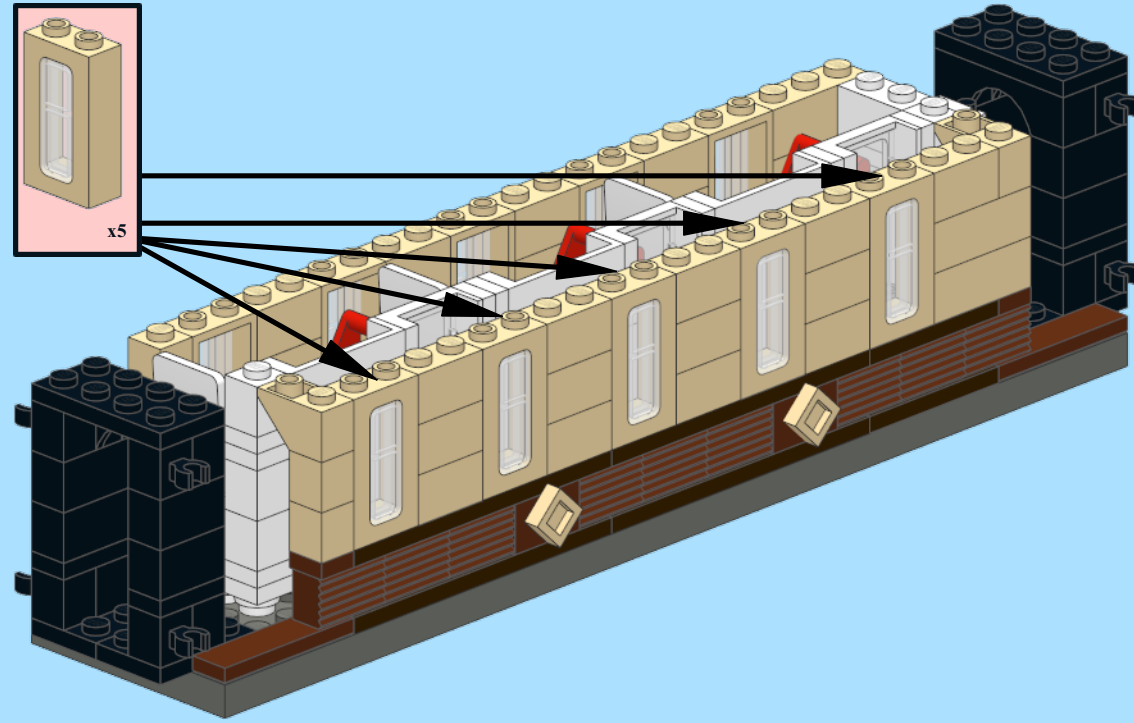
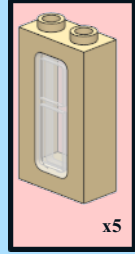
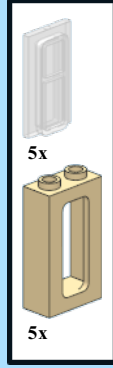

14

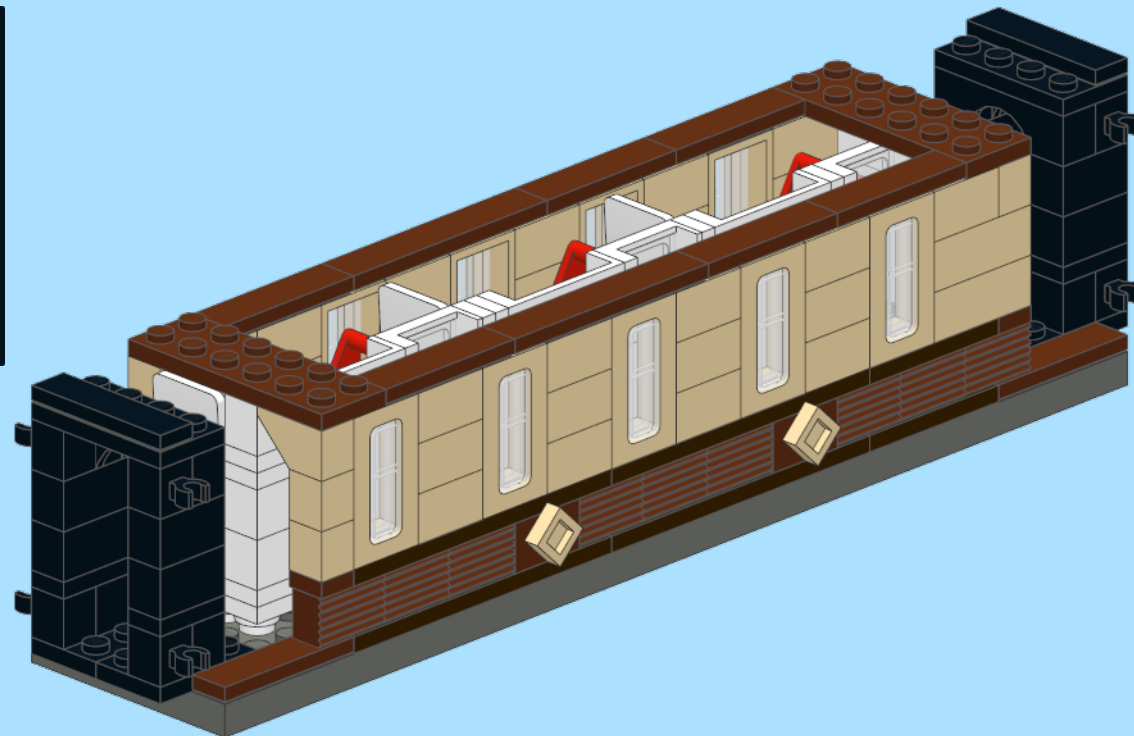
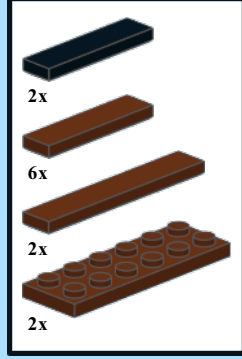

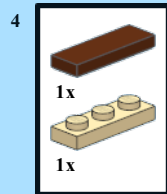
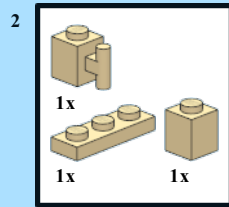
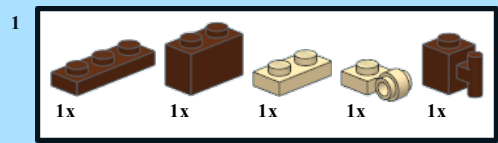

x2

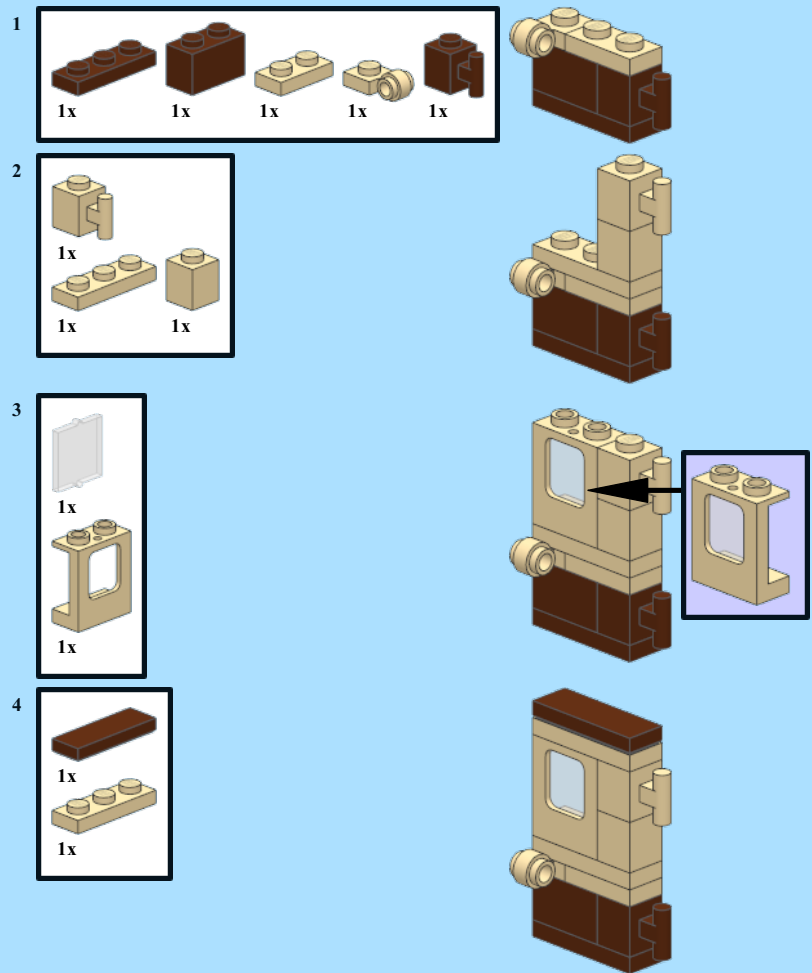

x2

