

Octan Tank Wagon



Original Design By:
Jesper Burgdorff Madsen
At www.byggepladen.dk

INSTRUCTION BY
KNUD ALBRECHTSEN
www.snakebyte.dk/lego

1

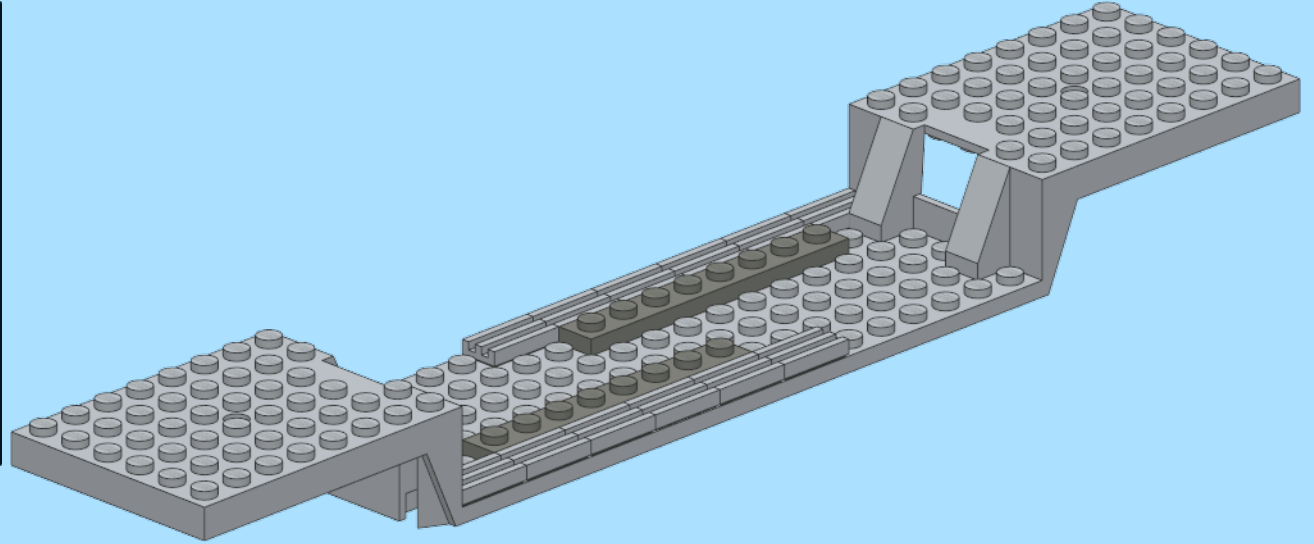
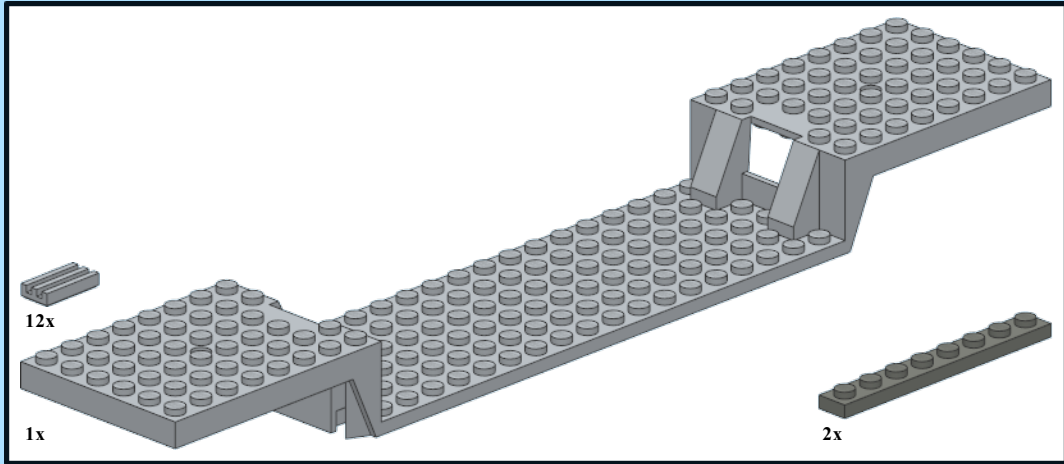



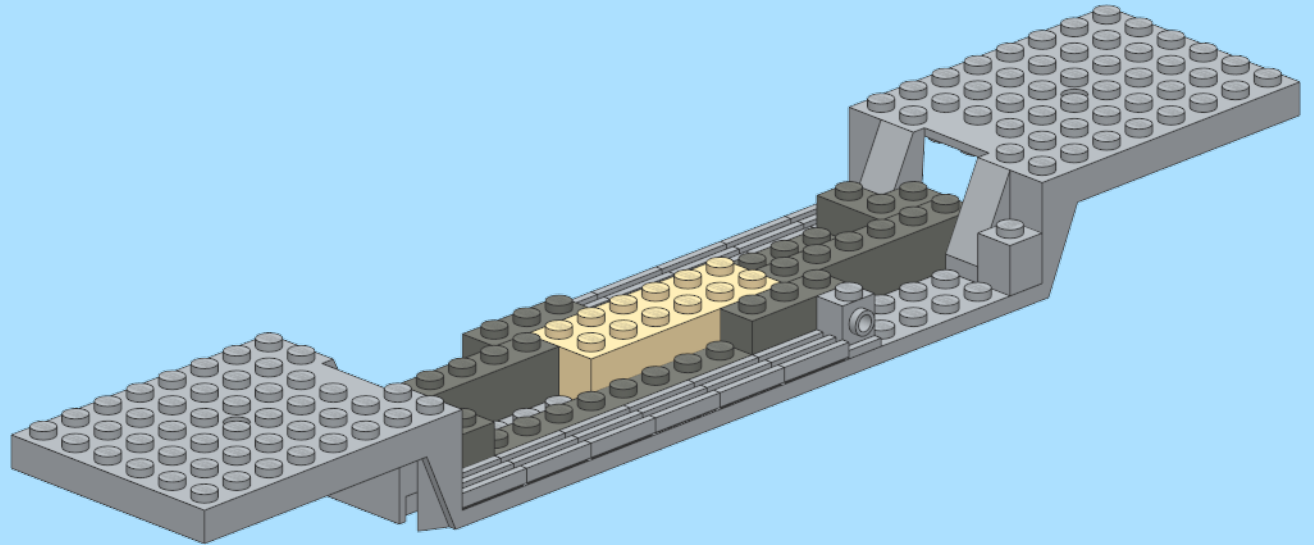
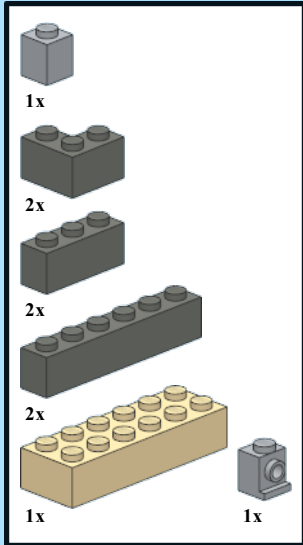

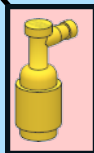
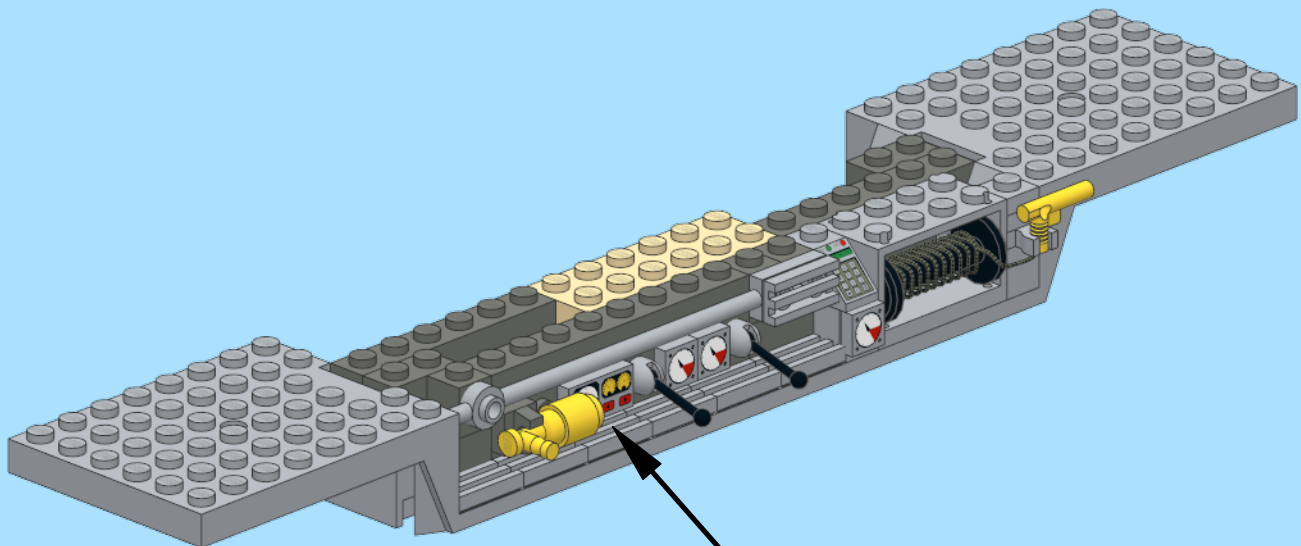

2



- 5
-  1x
 -  1x
 -  1x



- 6
-  1x
 -  1x
 -  1x
 -  1x
 -  2x
 -  1x
 -  2x

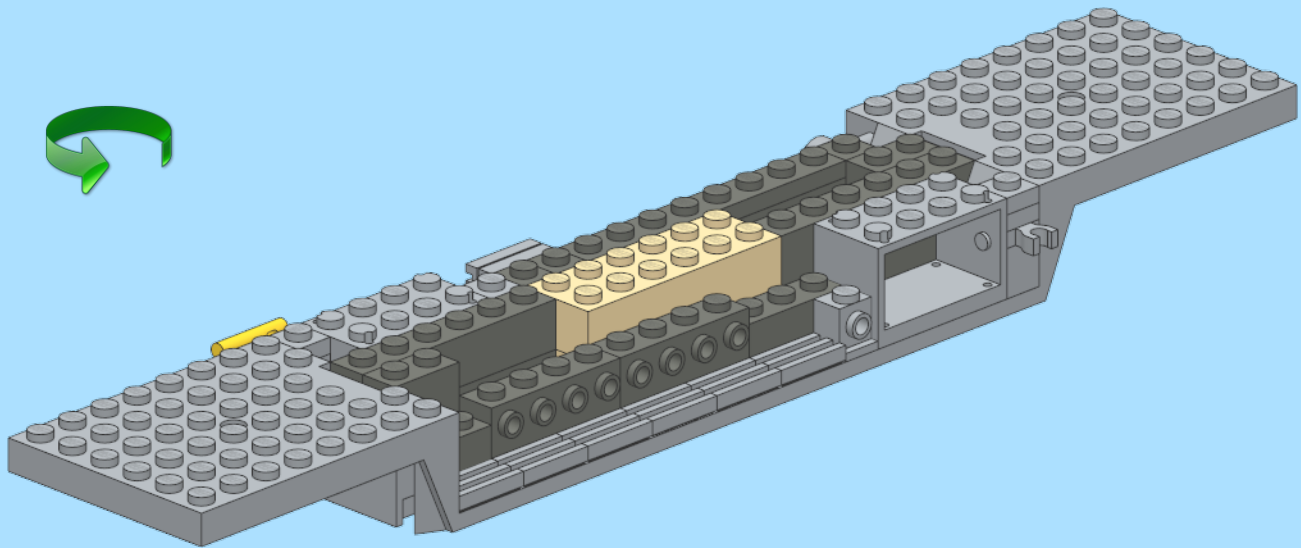

7

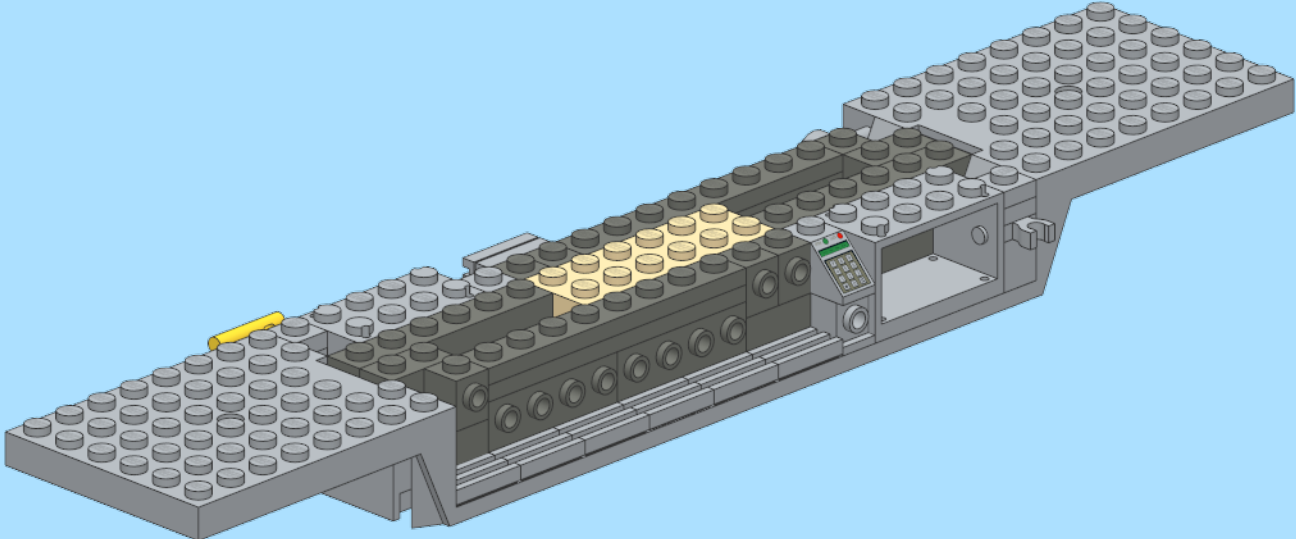
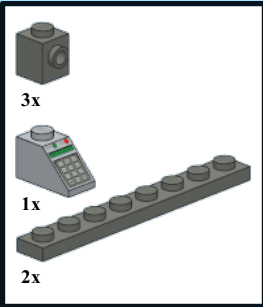

8

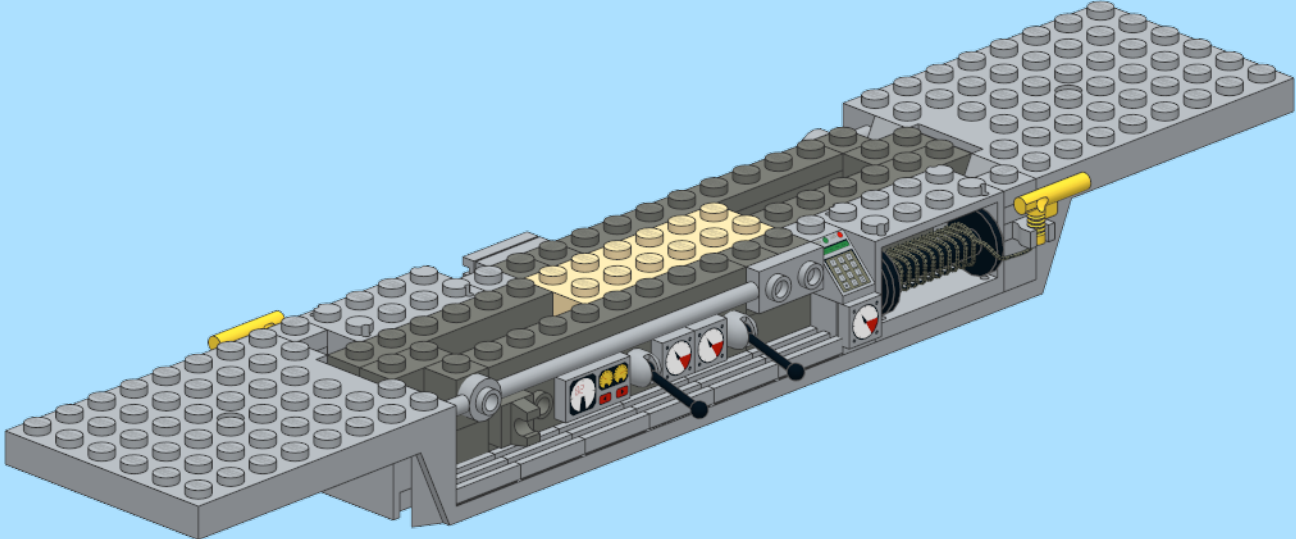
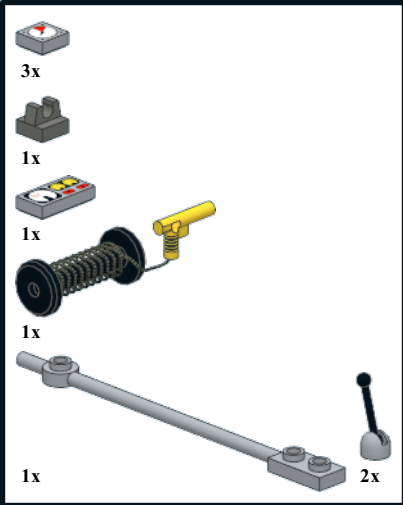

9

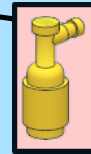
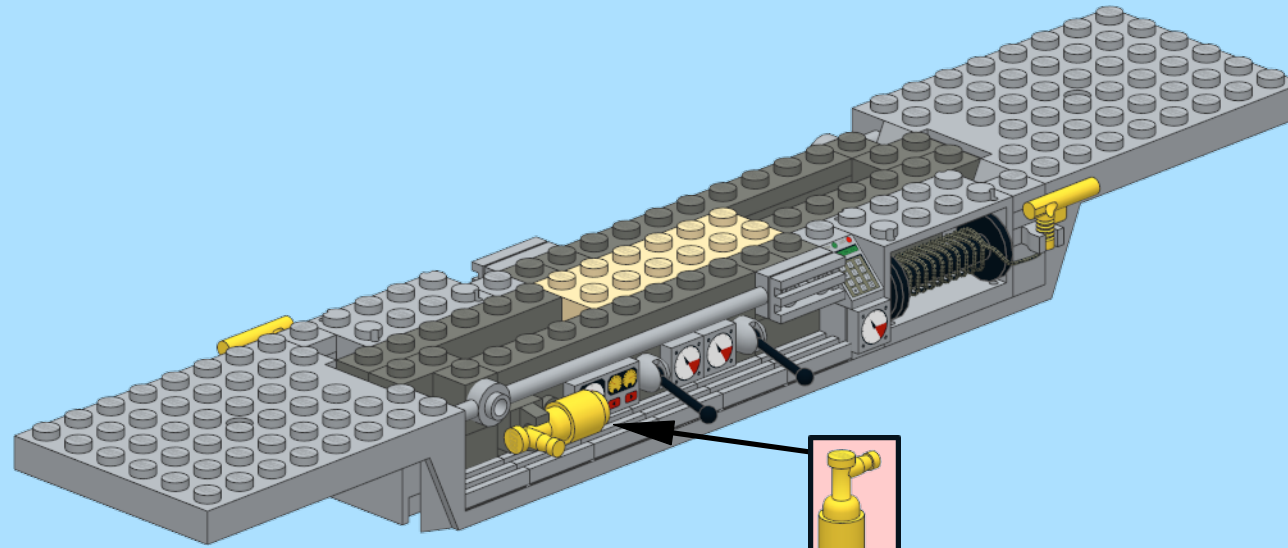

10

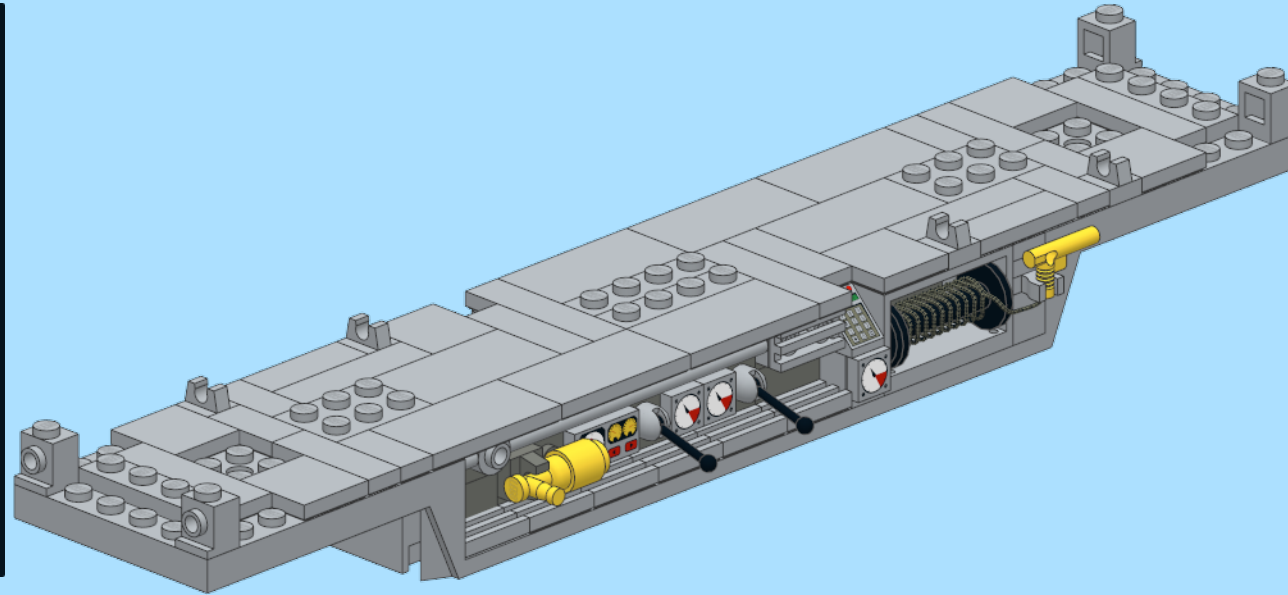
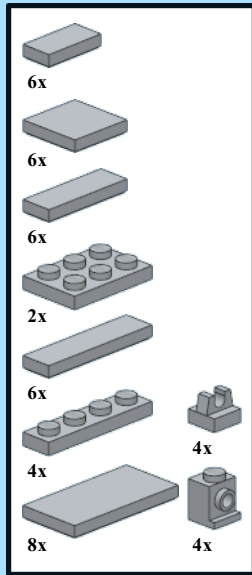

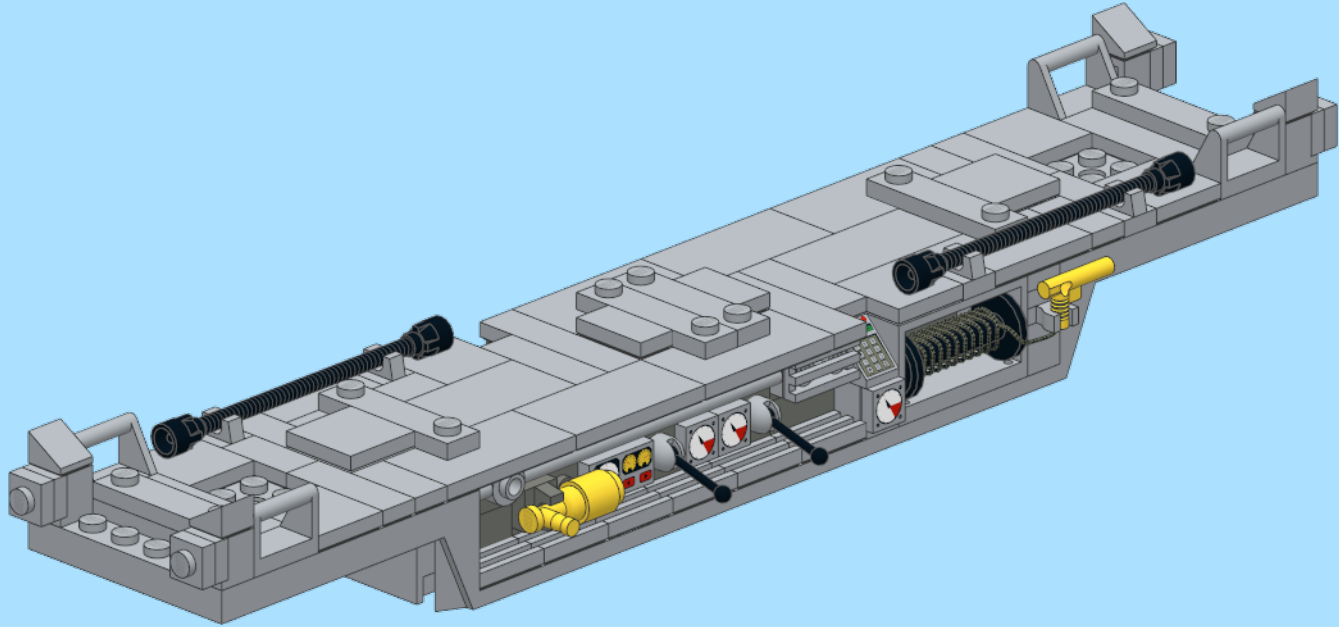
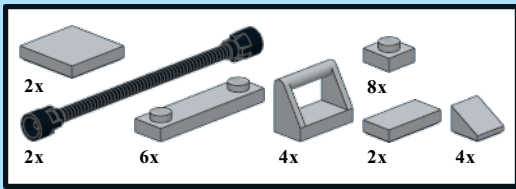

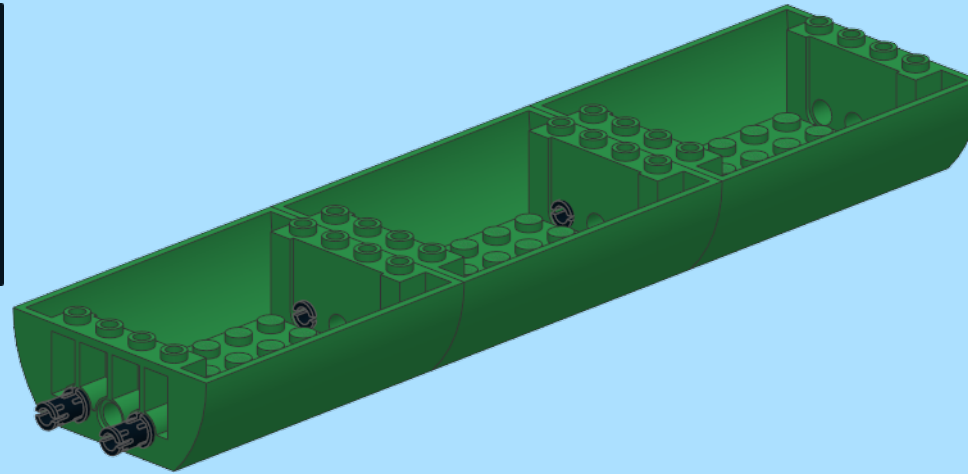
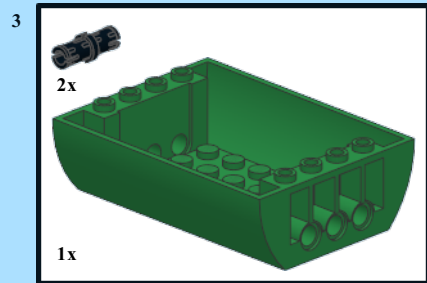
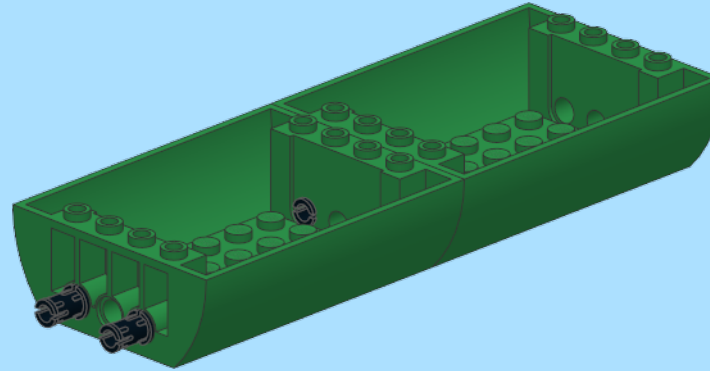
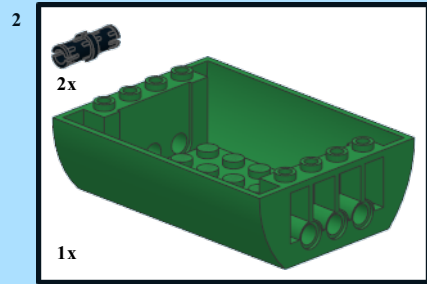
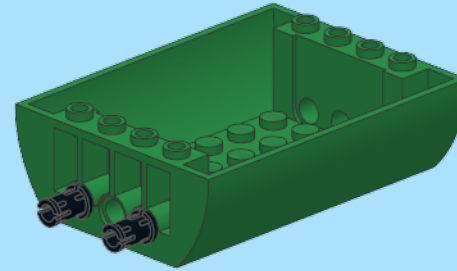
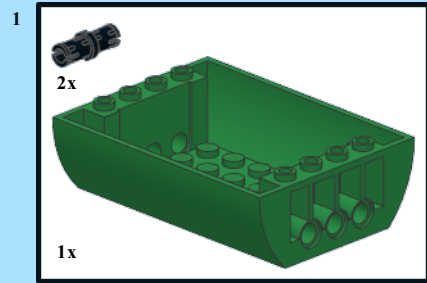

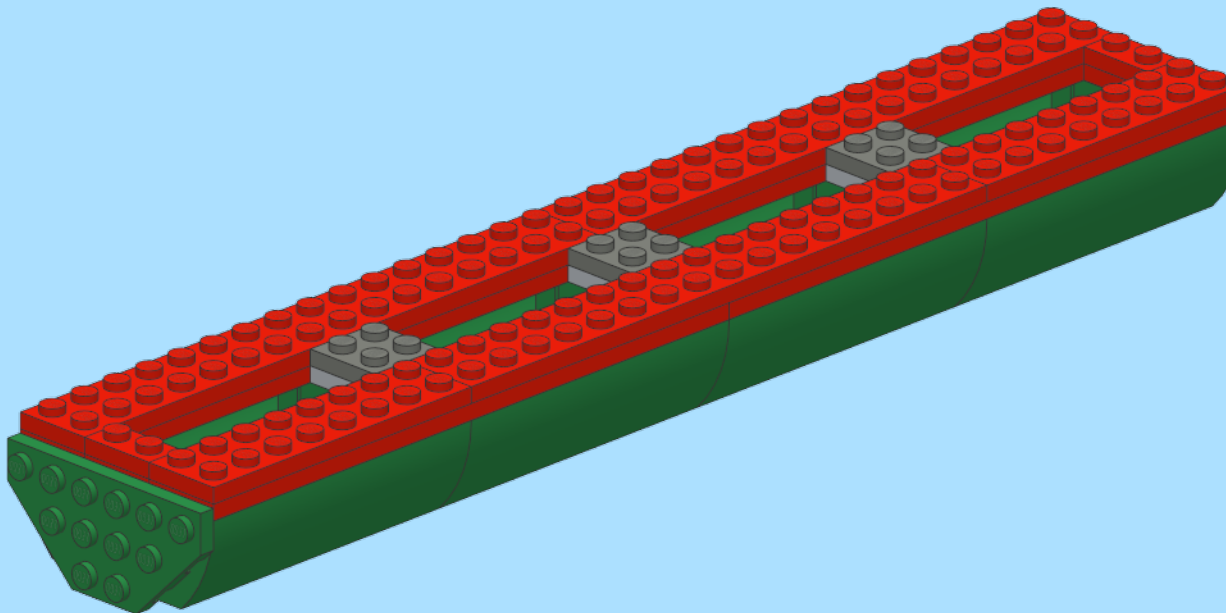
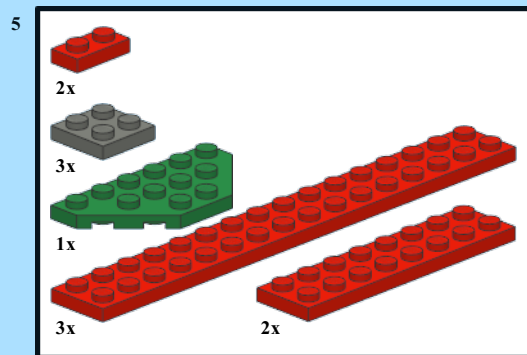
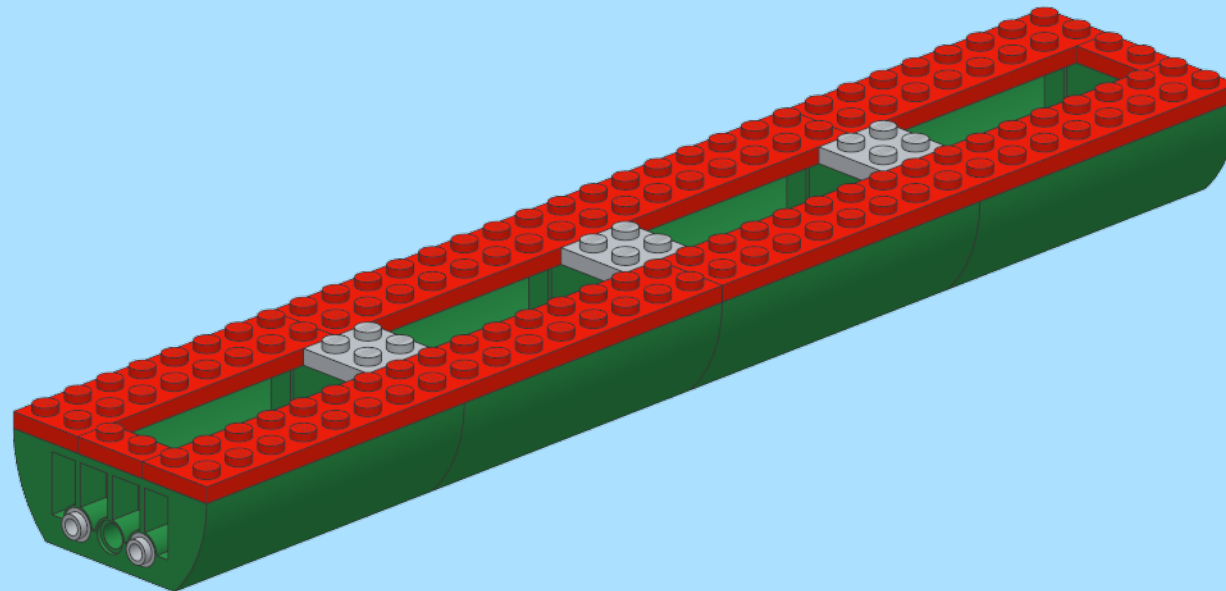
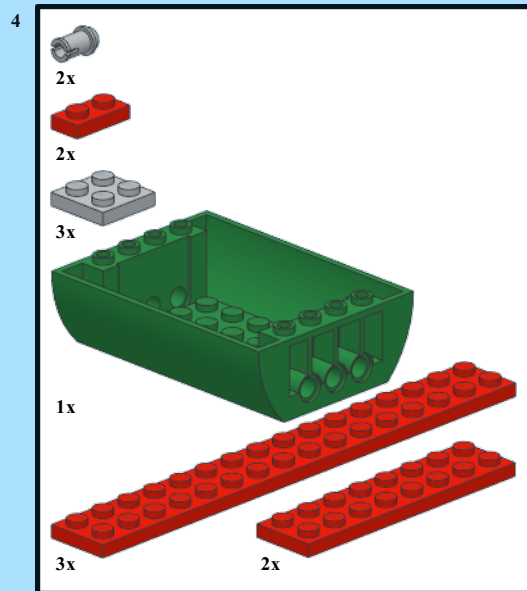

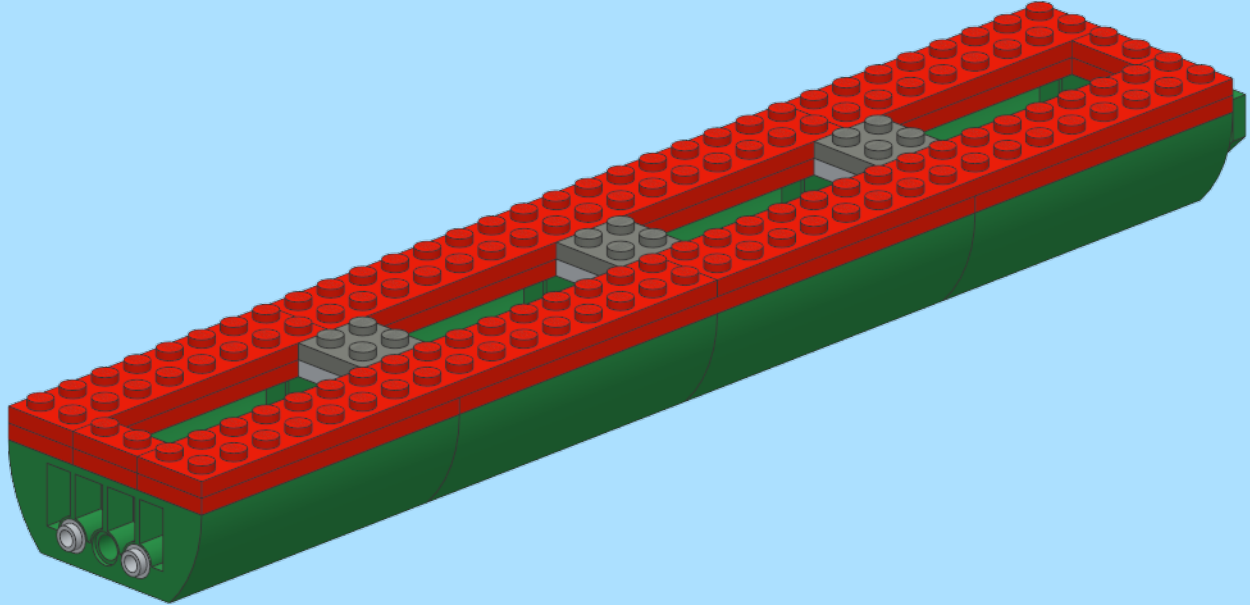

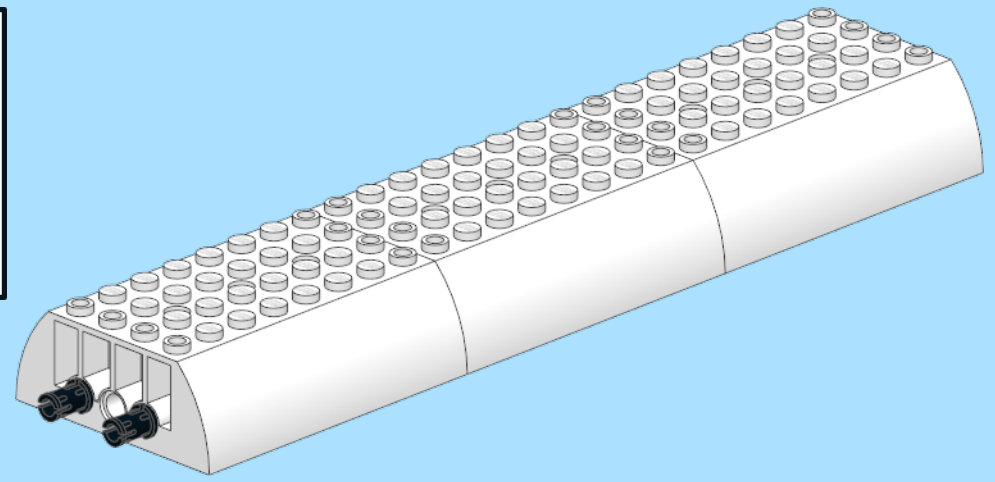
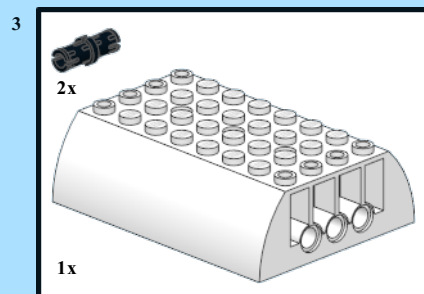
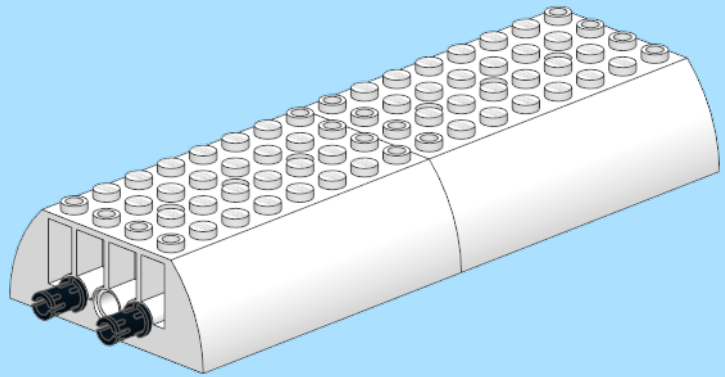
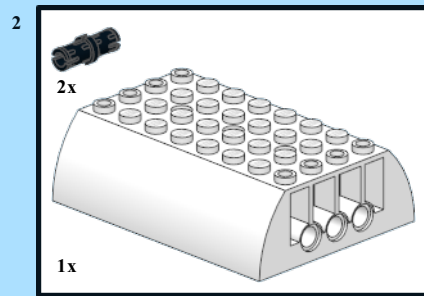
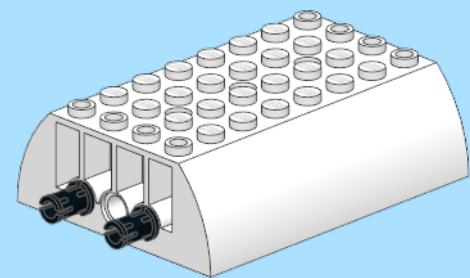
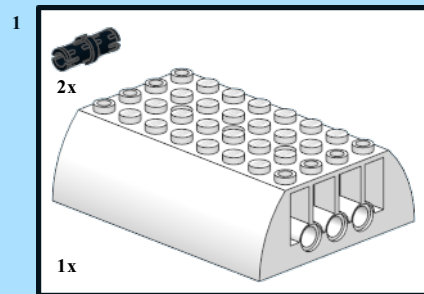

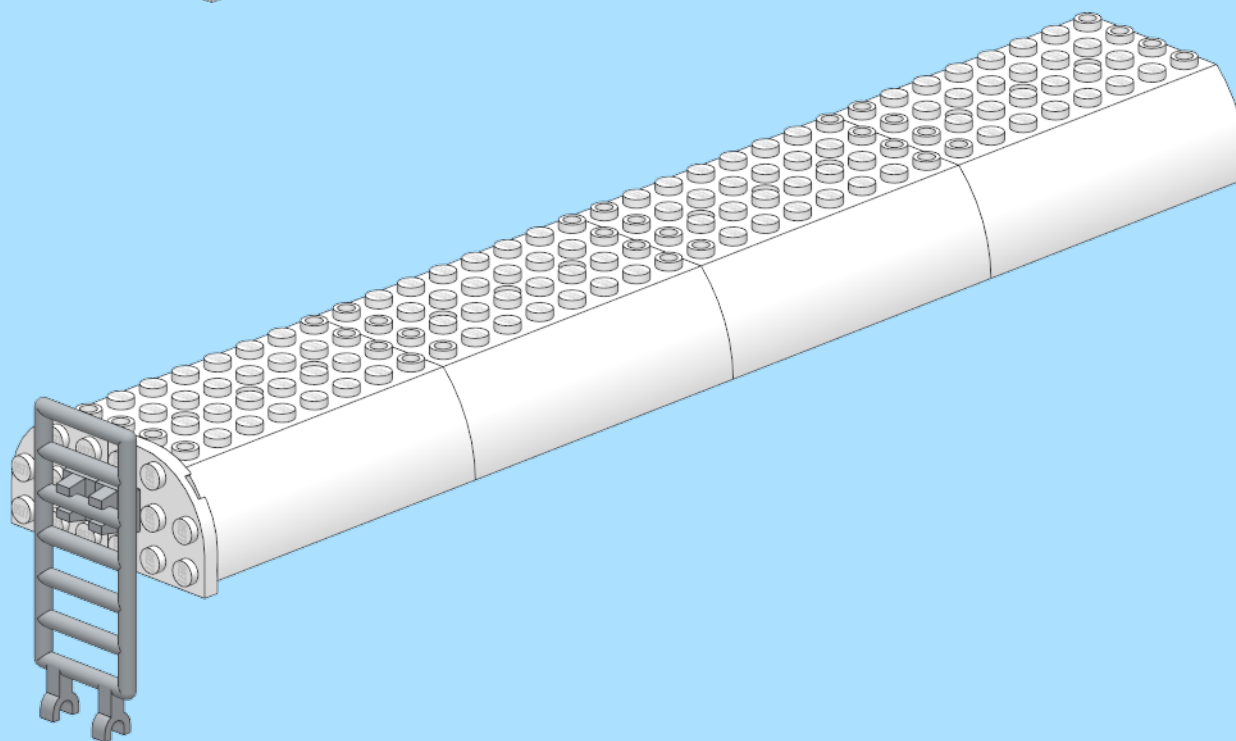
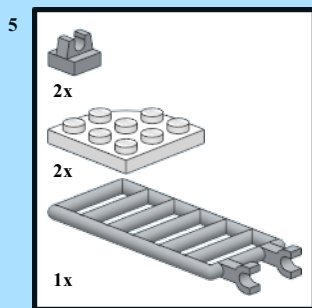
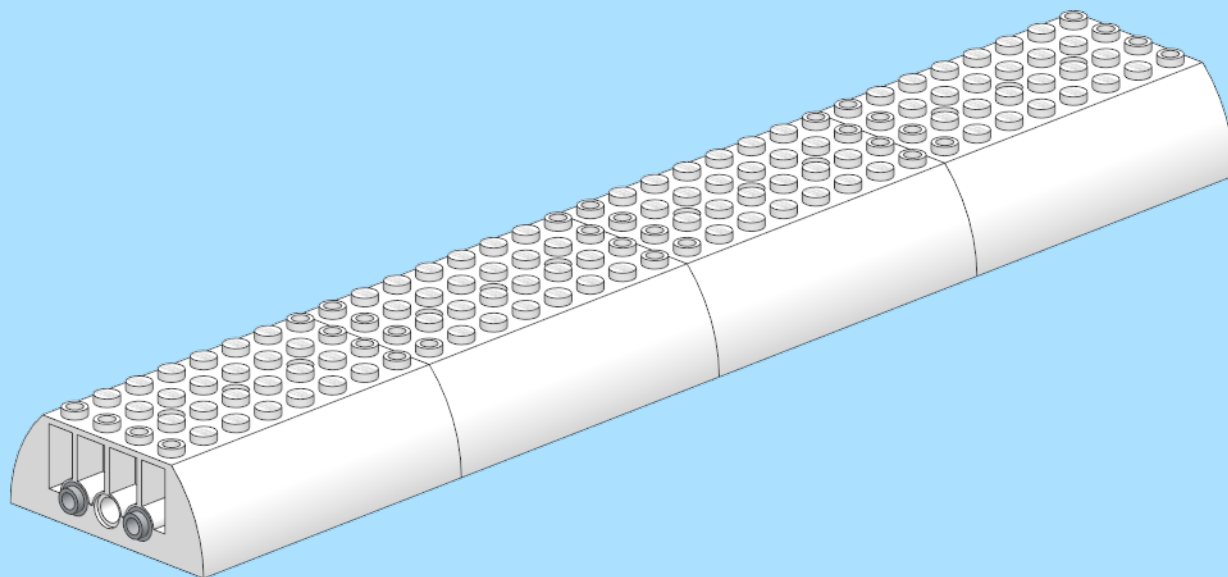
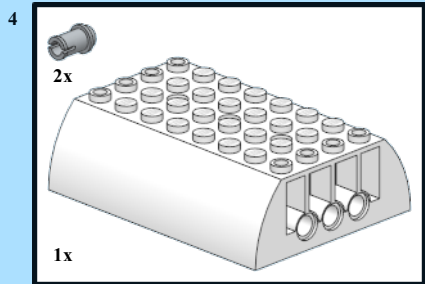

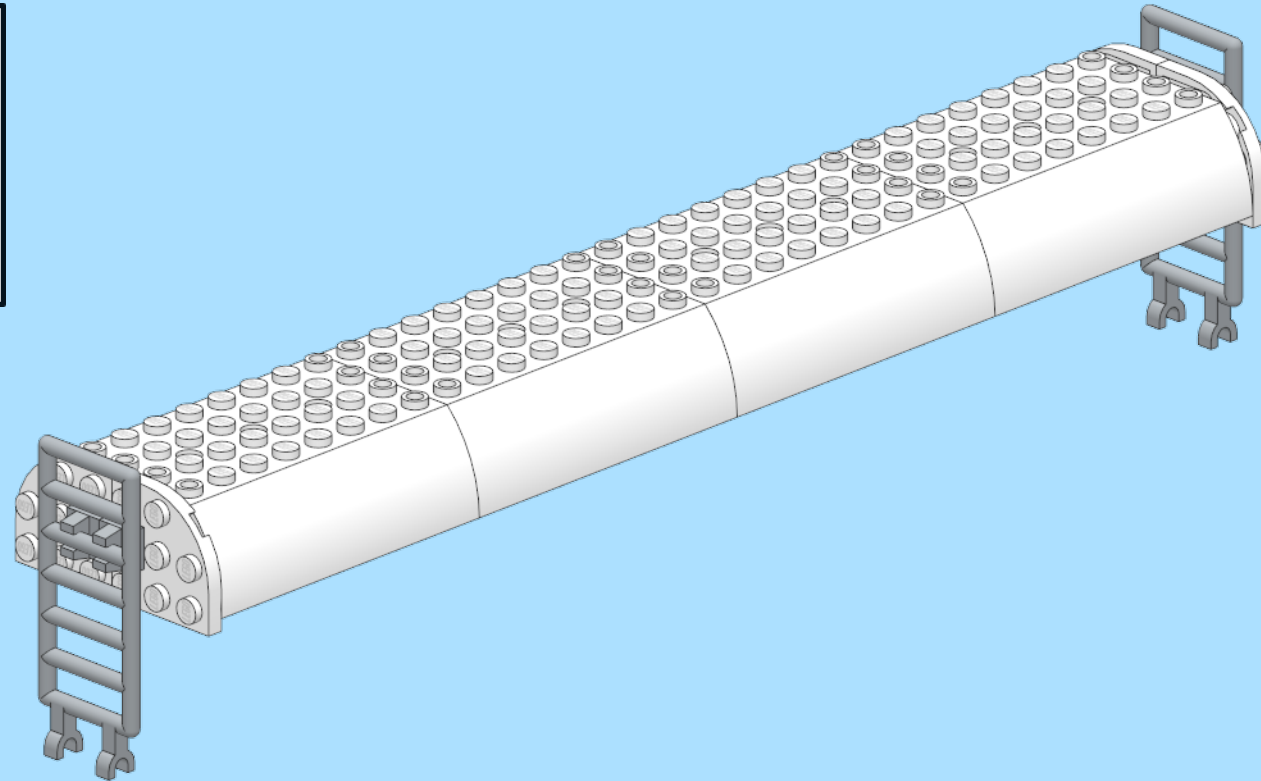
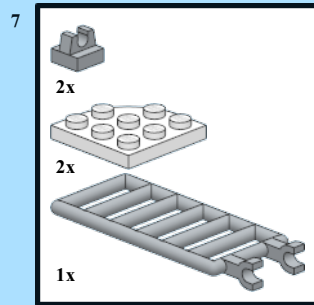
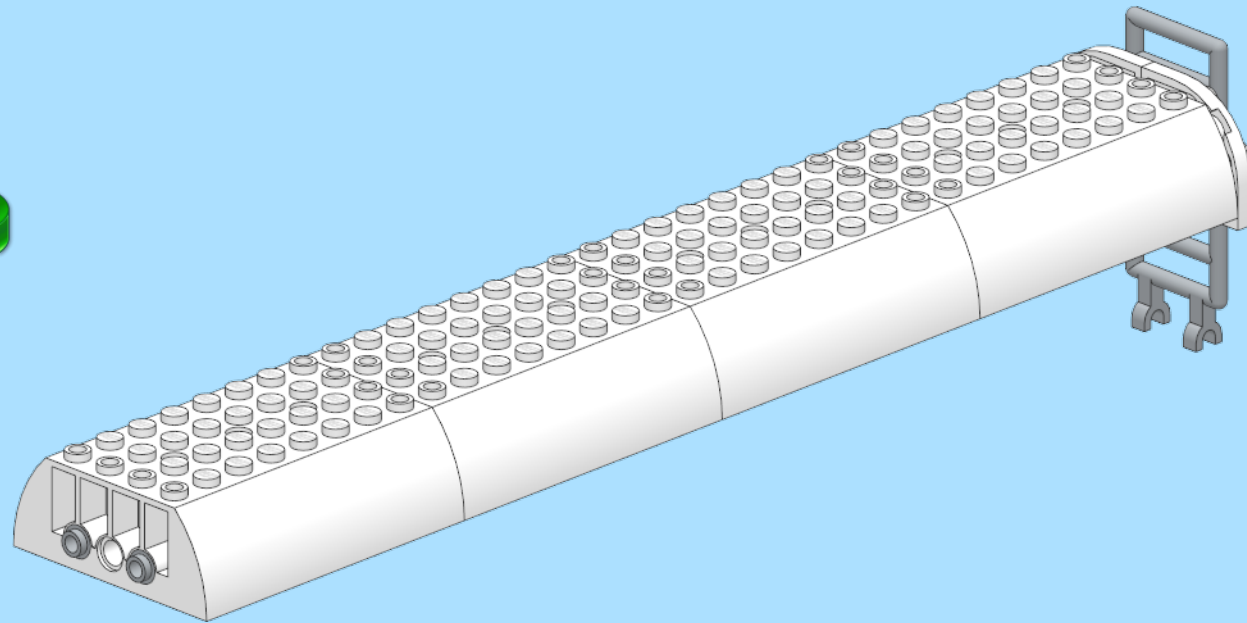
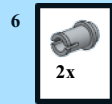

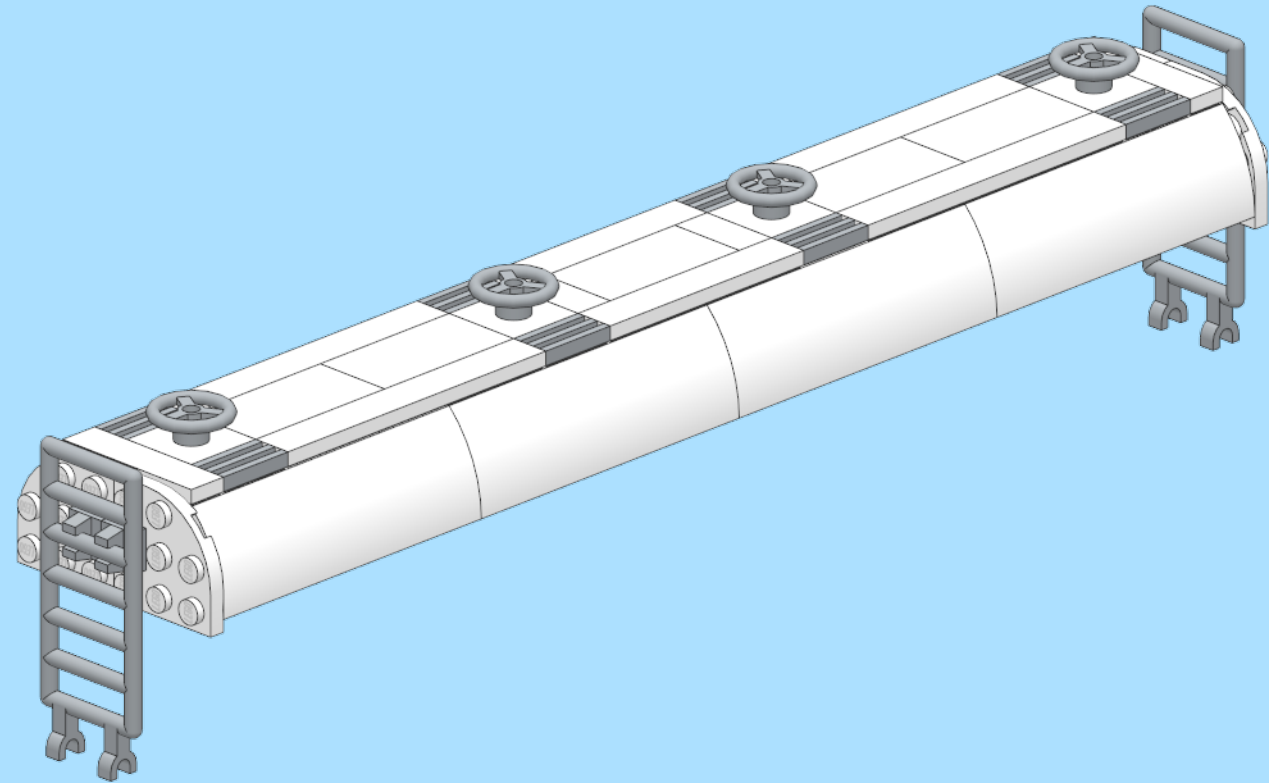
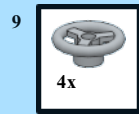
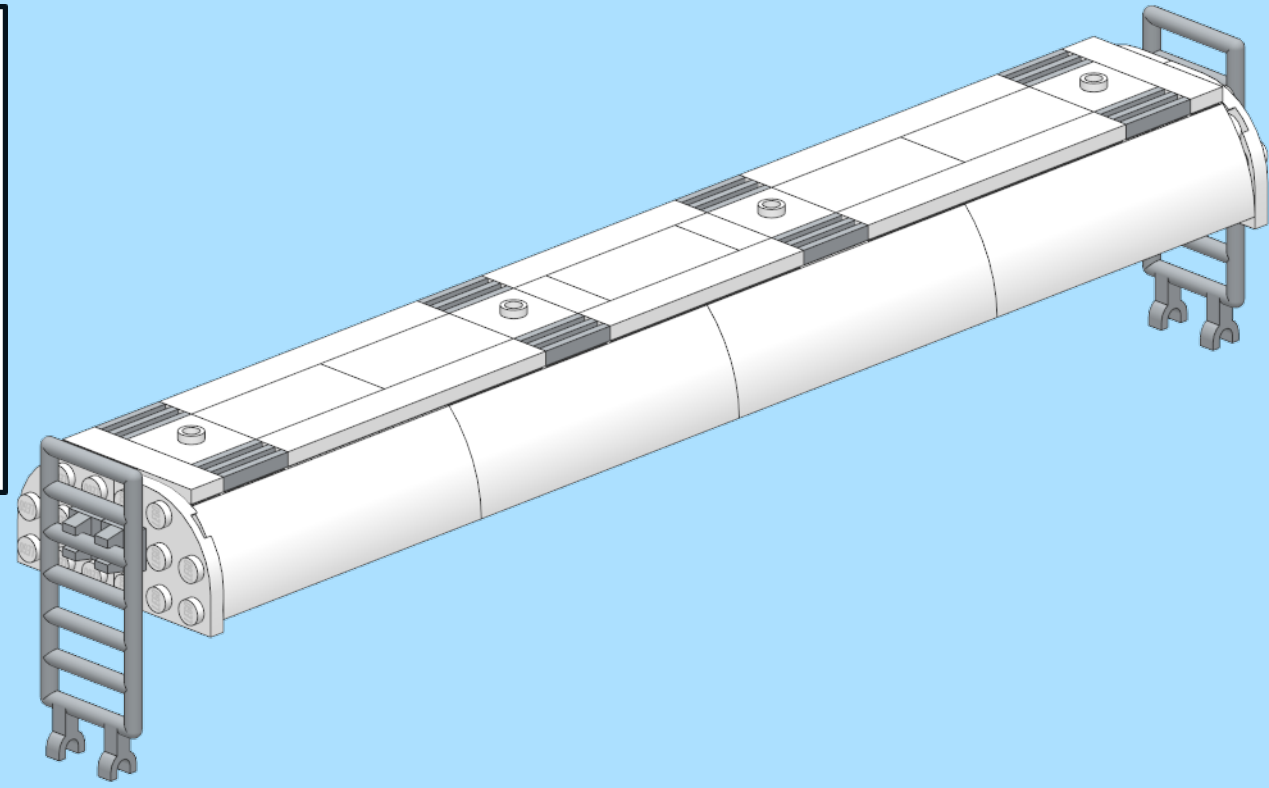
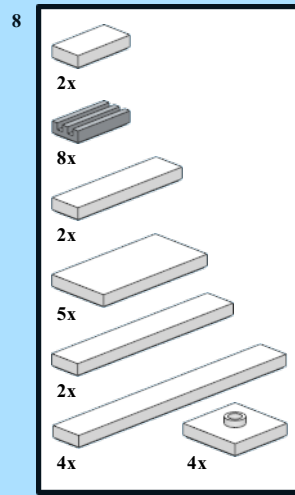

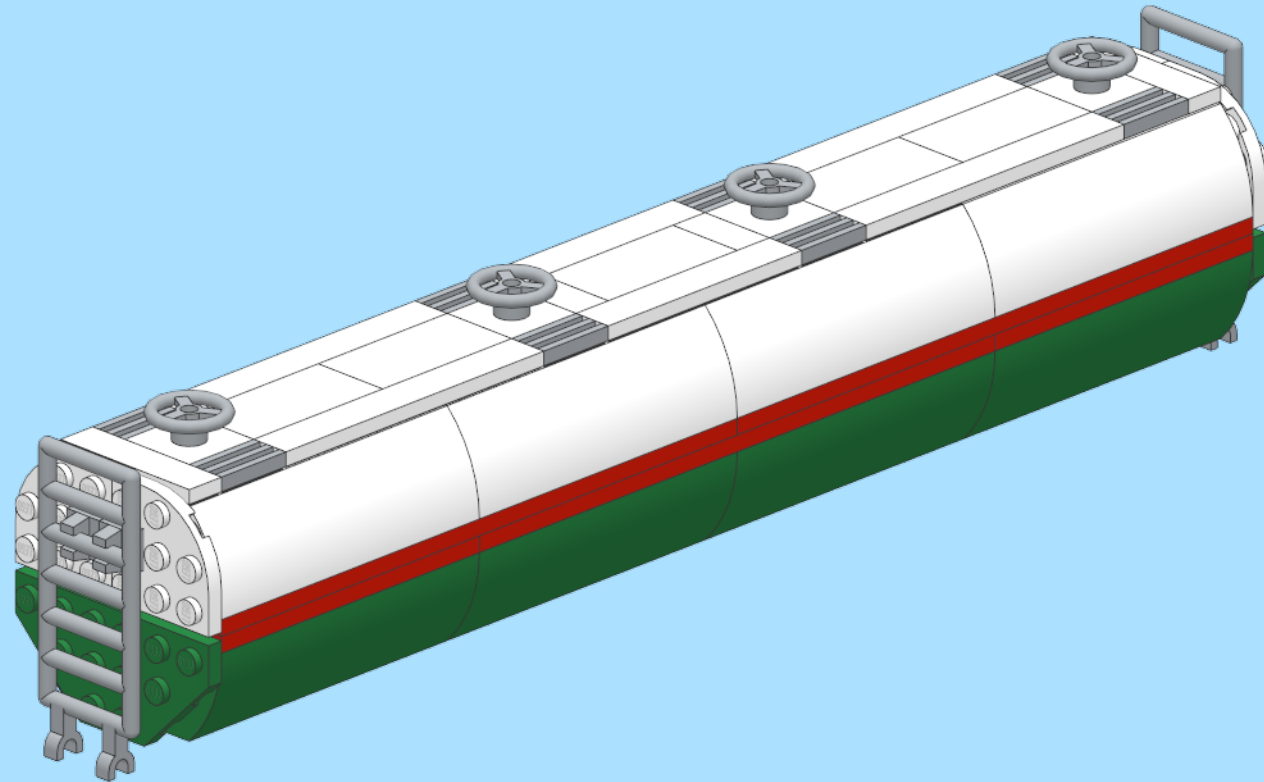
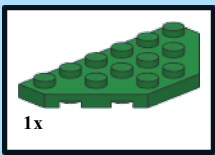

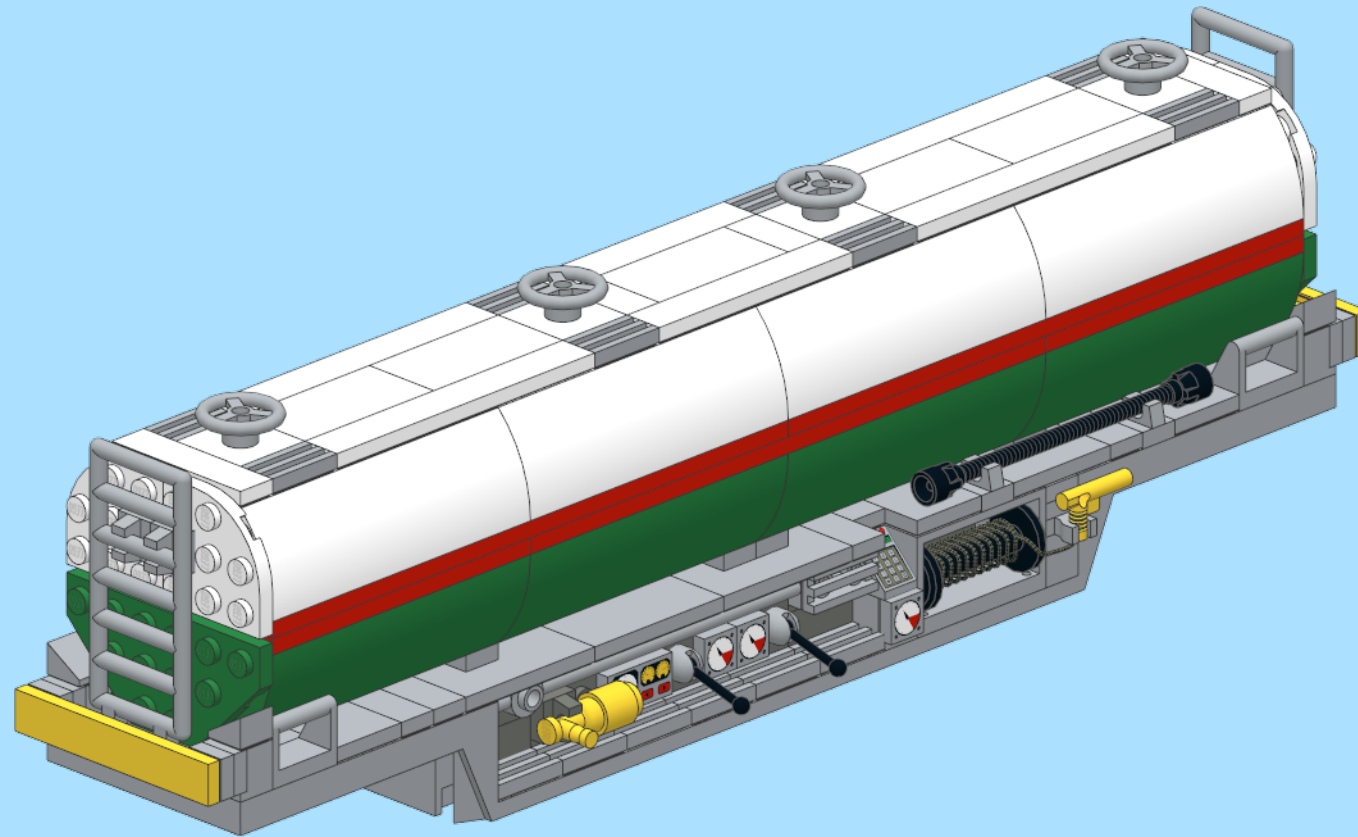
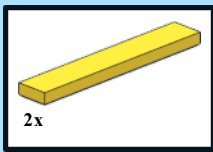

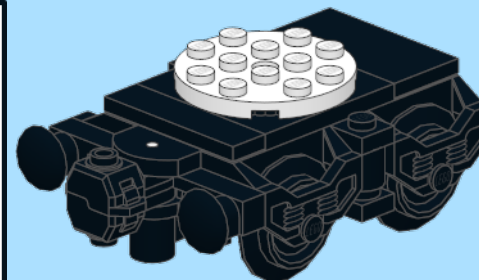
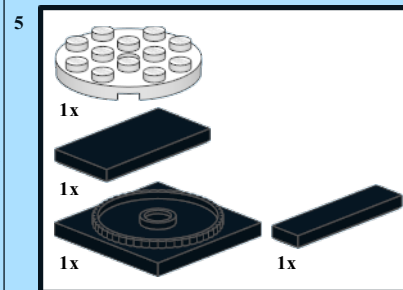
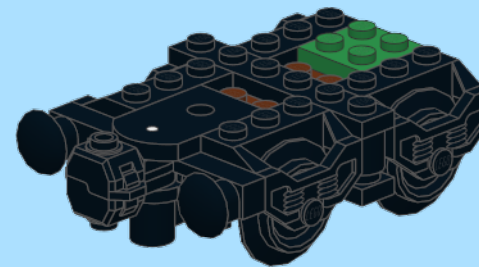
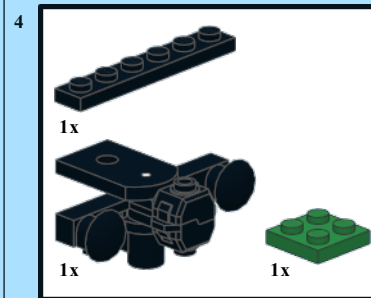
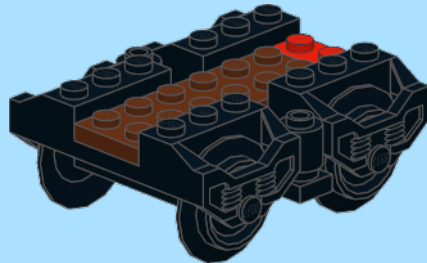
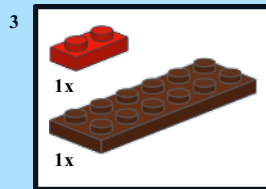
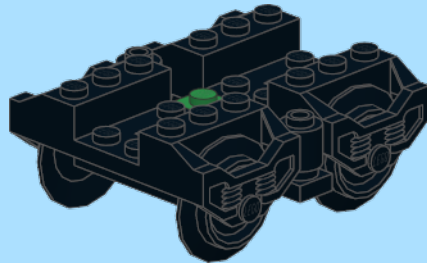
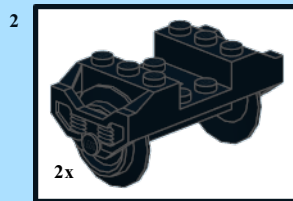
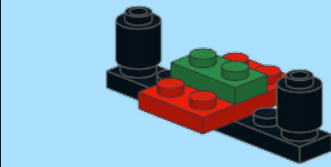
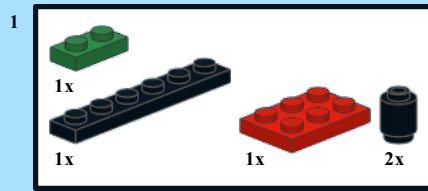

x2

