

Pacific Dining Car

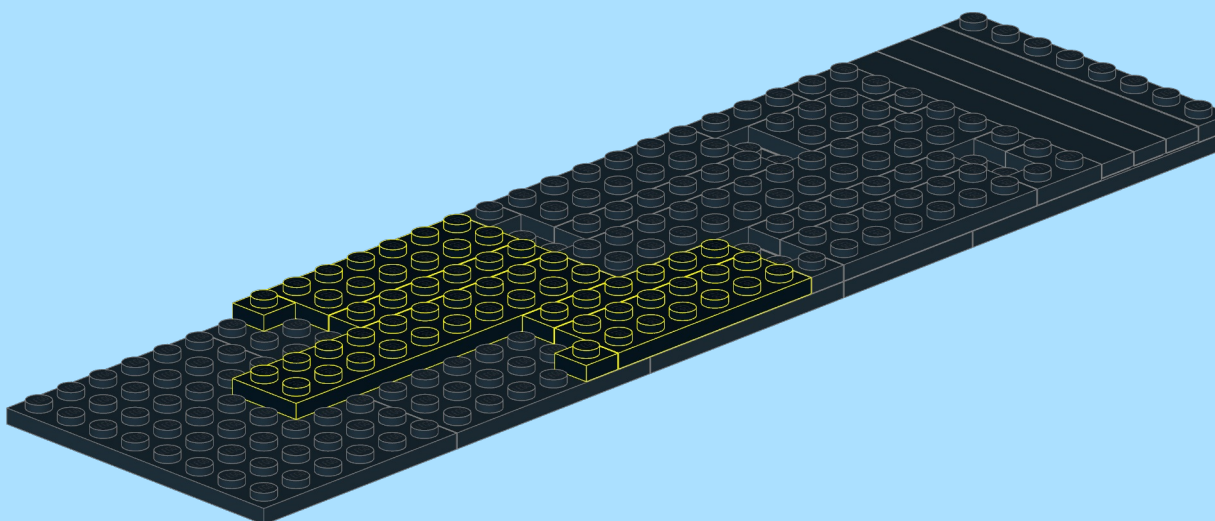

DESIGNED BY
KNUD ALBRECHTSEN
www.snakebyte.dk/lego

INSTRUCTION BY
KNUD ALBRECHTSEN
www.snakebyte.dk/lego

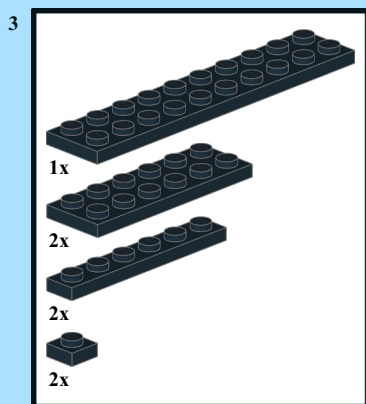
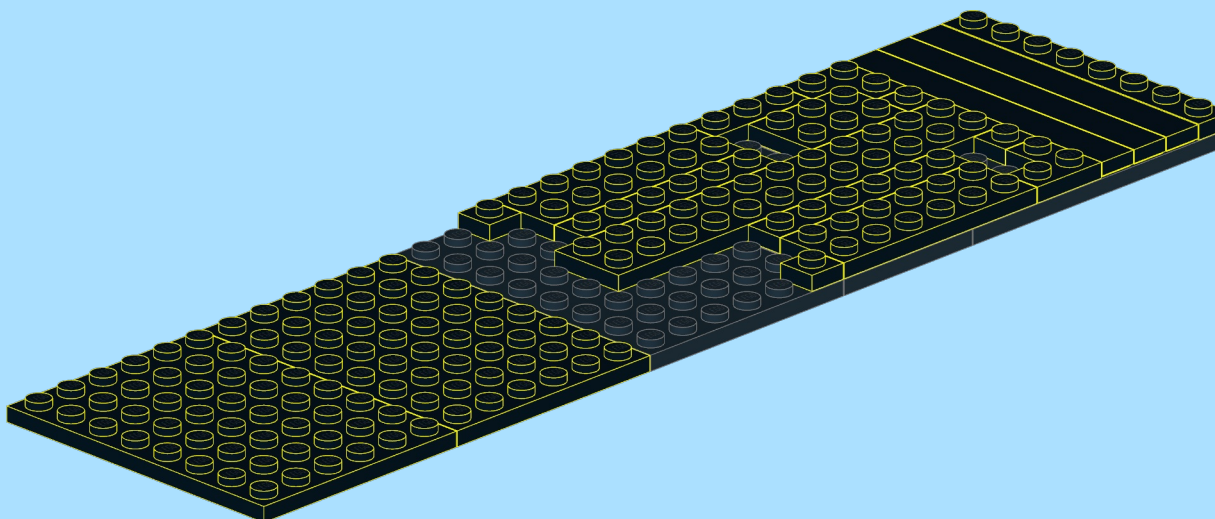
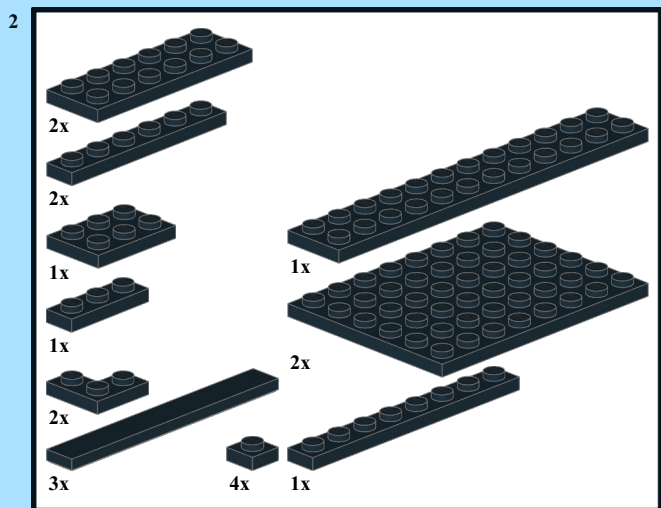
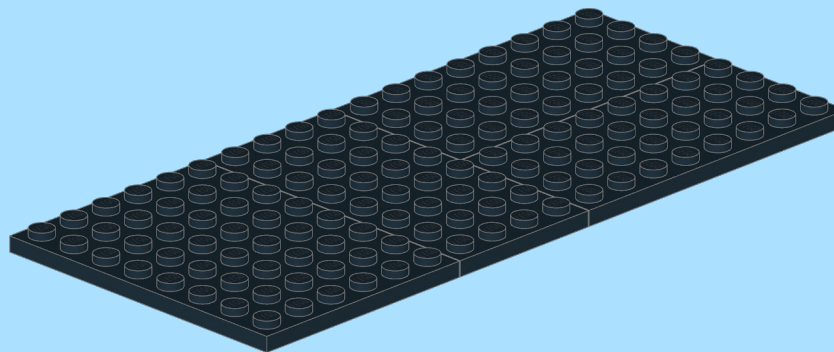
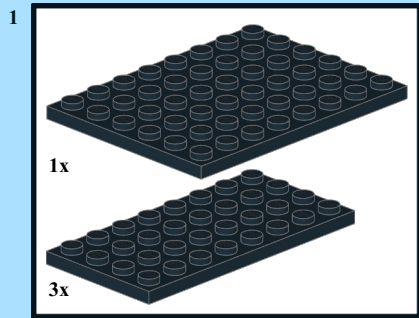

4

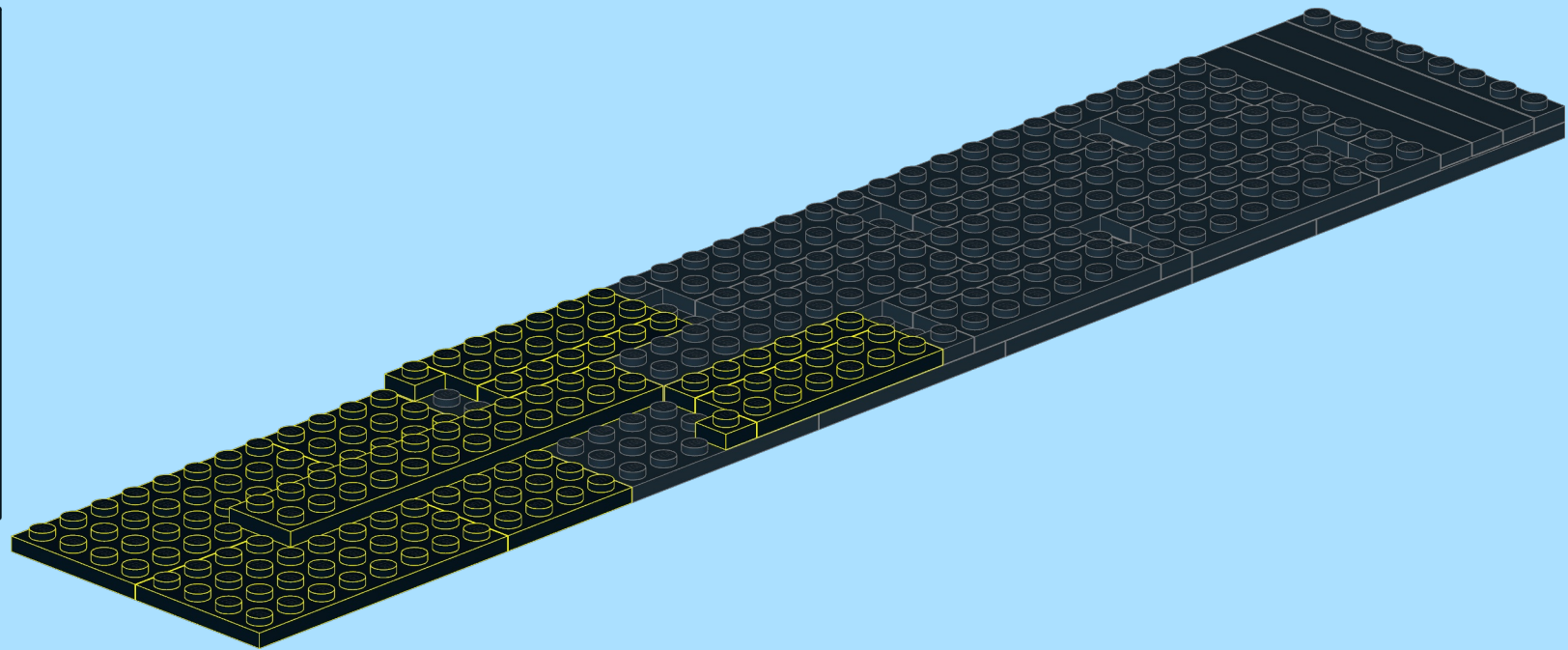
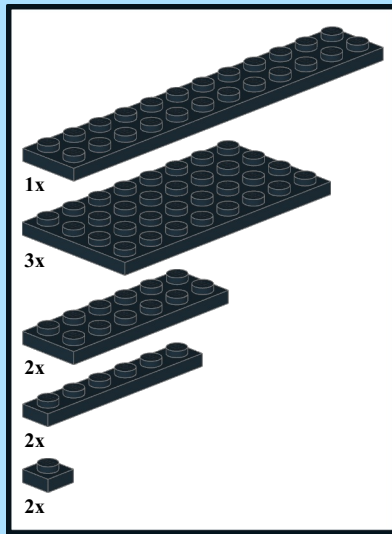

5

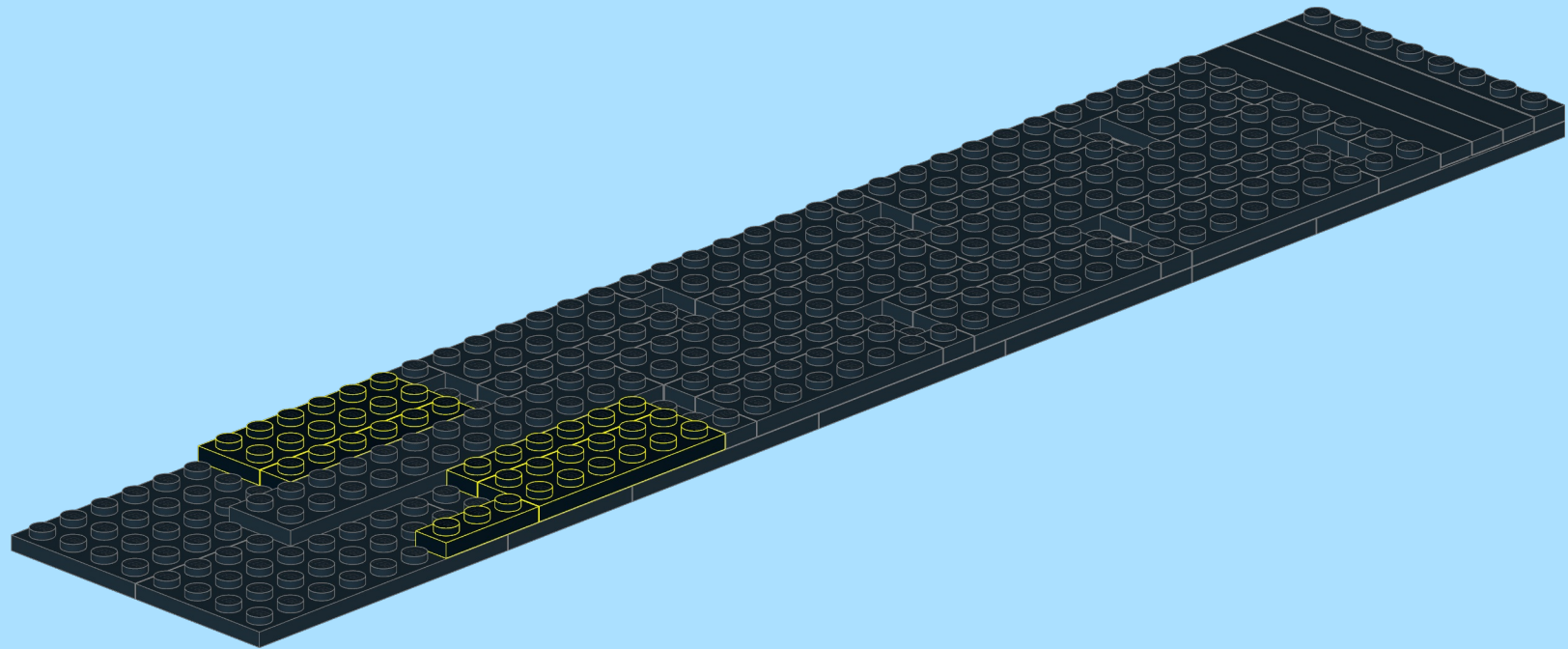
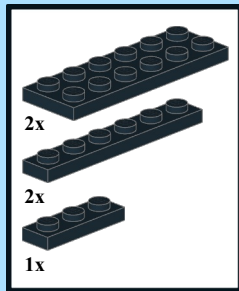

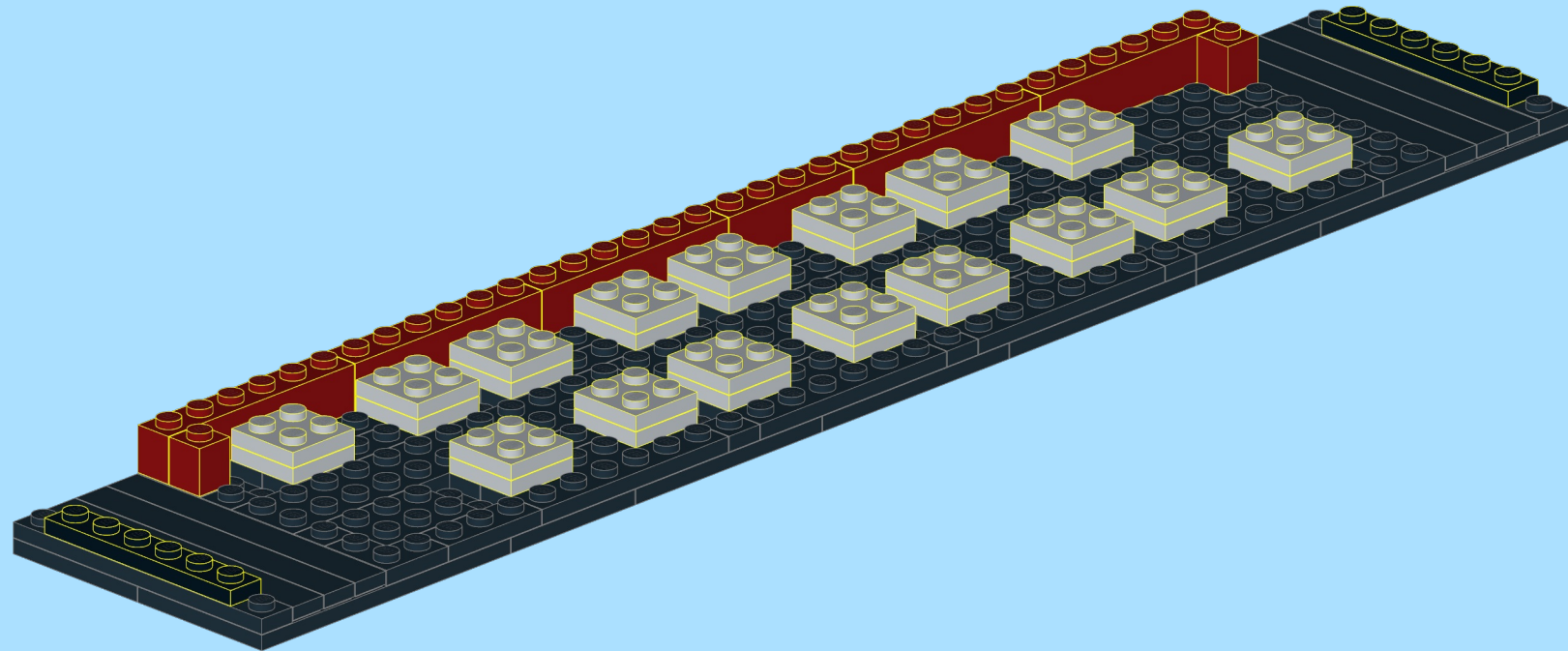
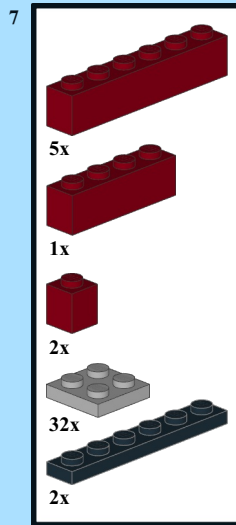
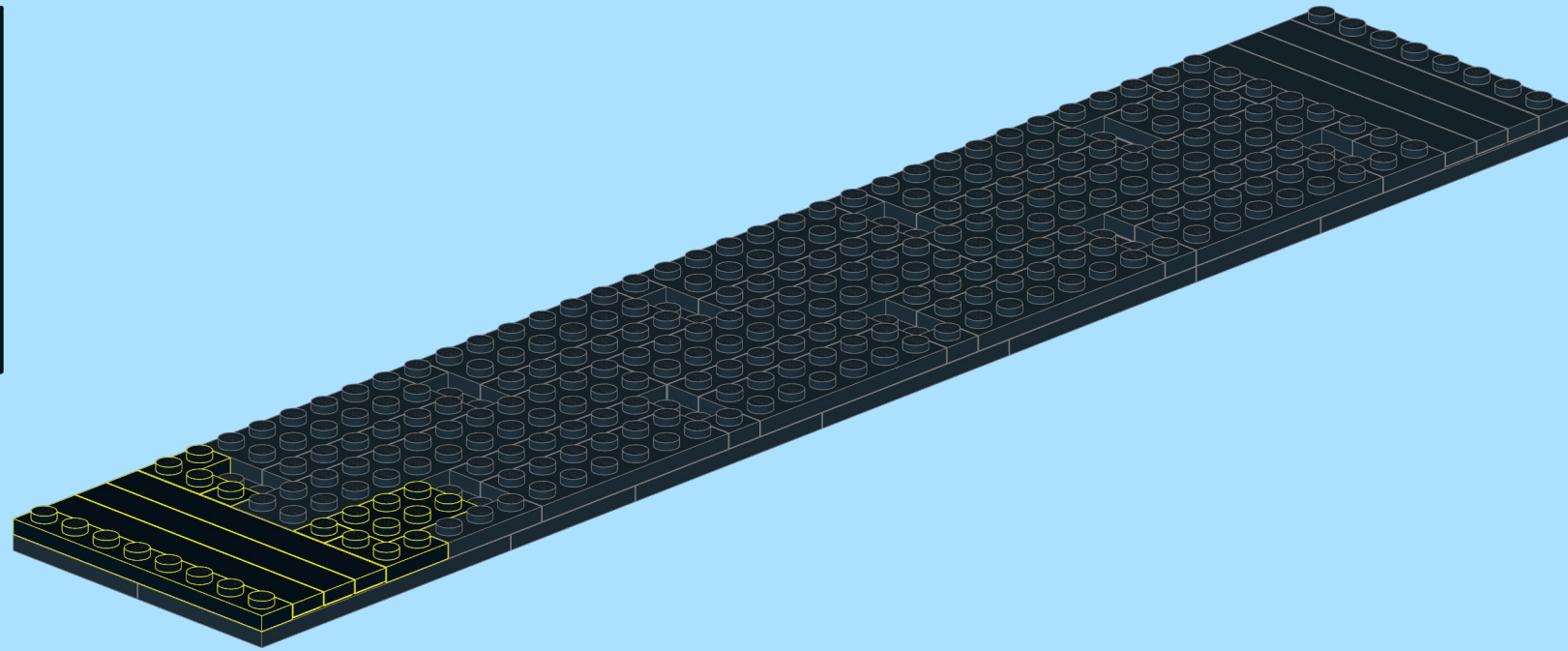
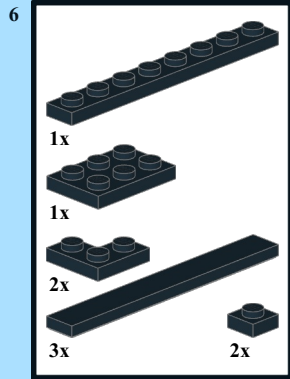

8

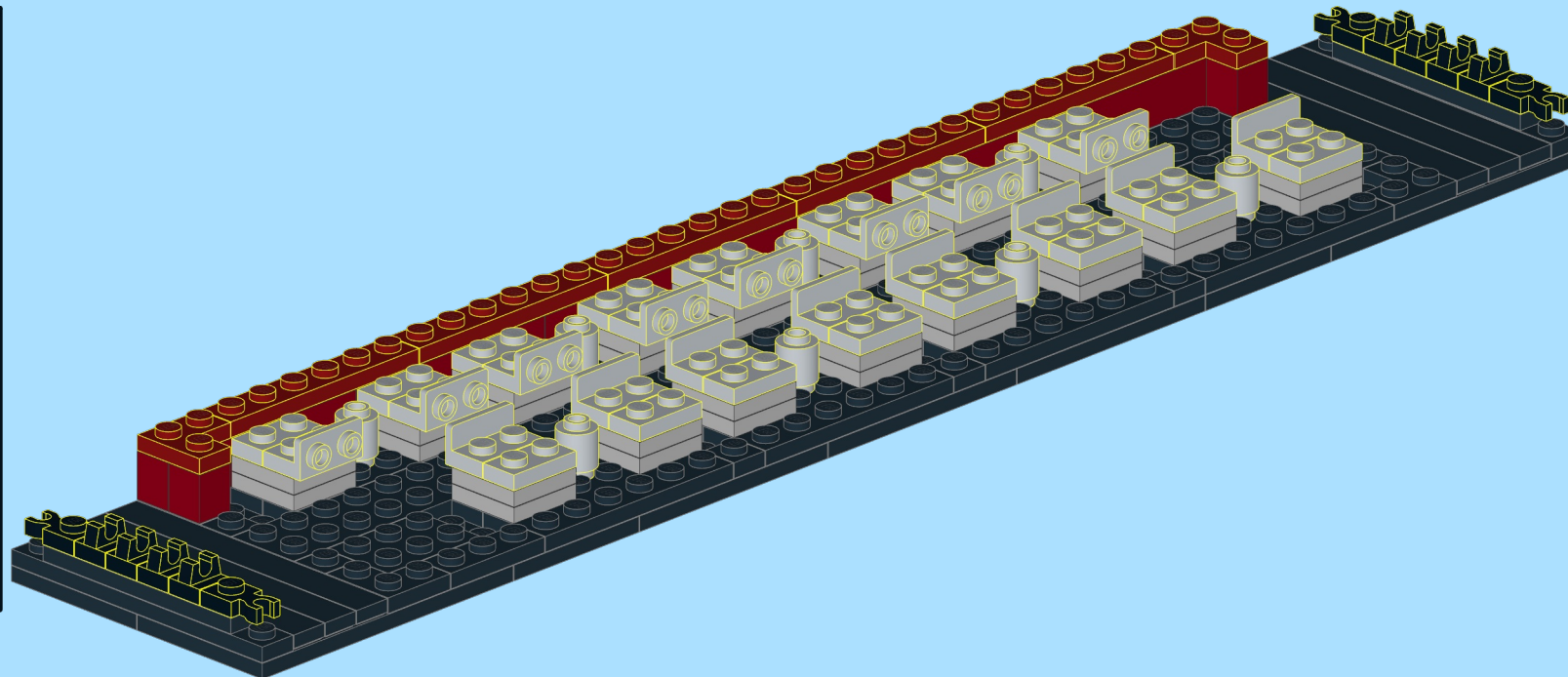
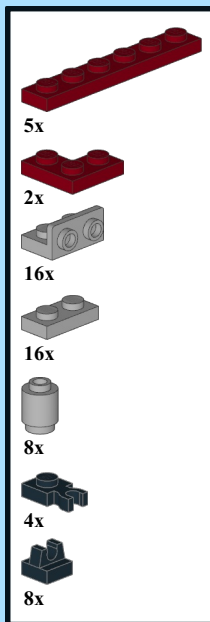

9

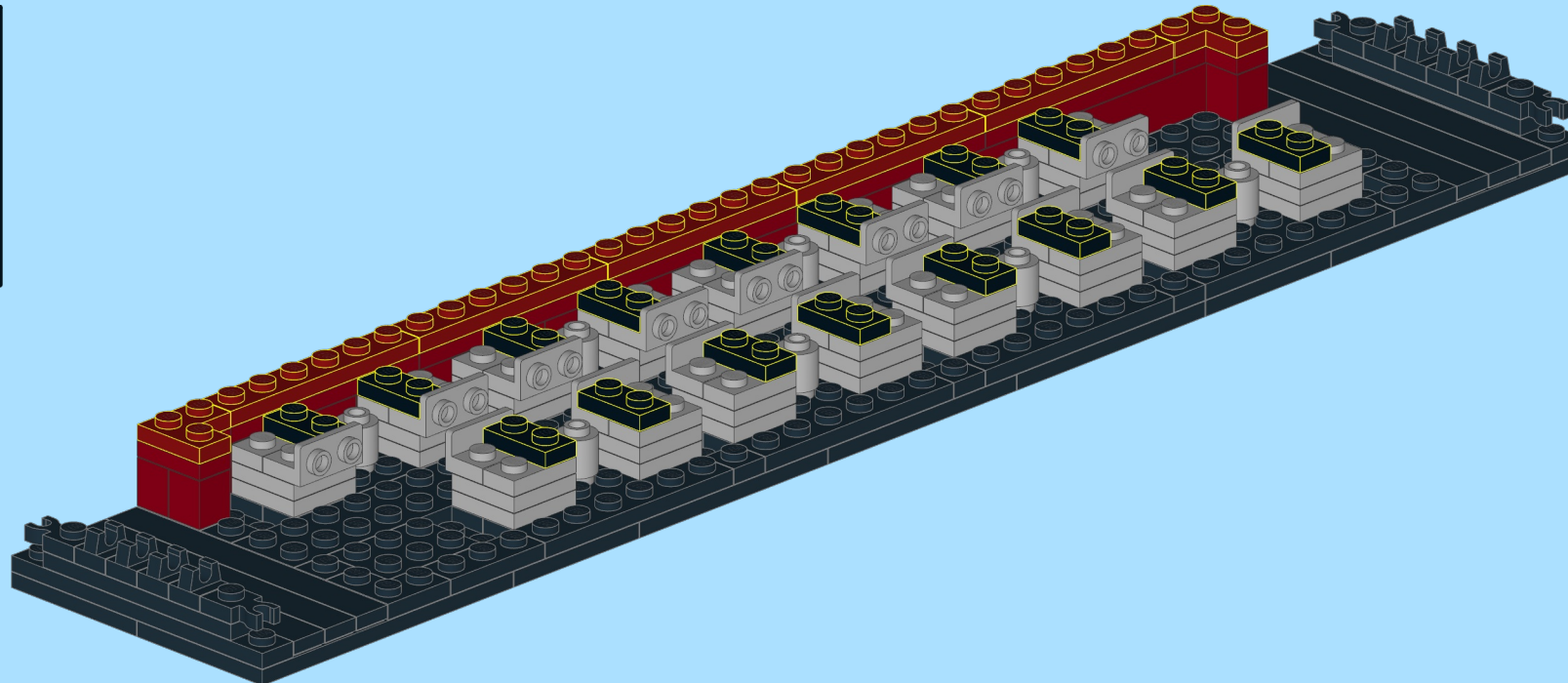
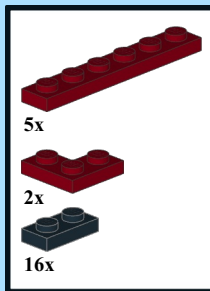

10

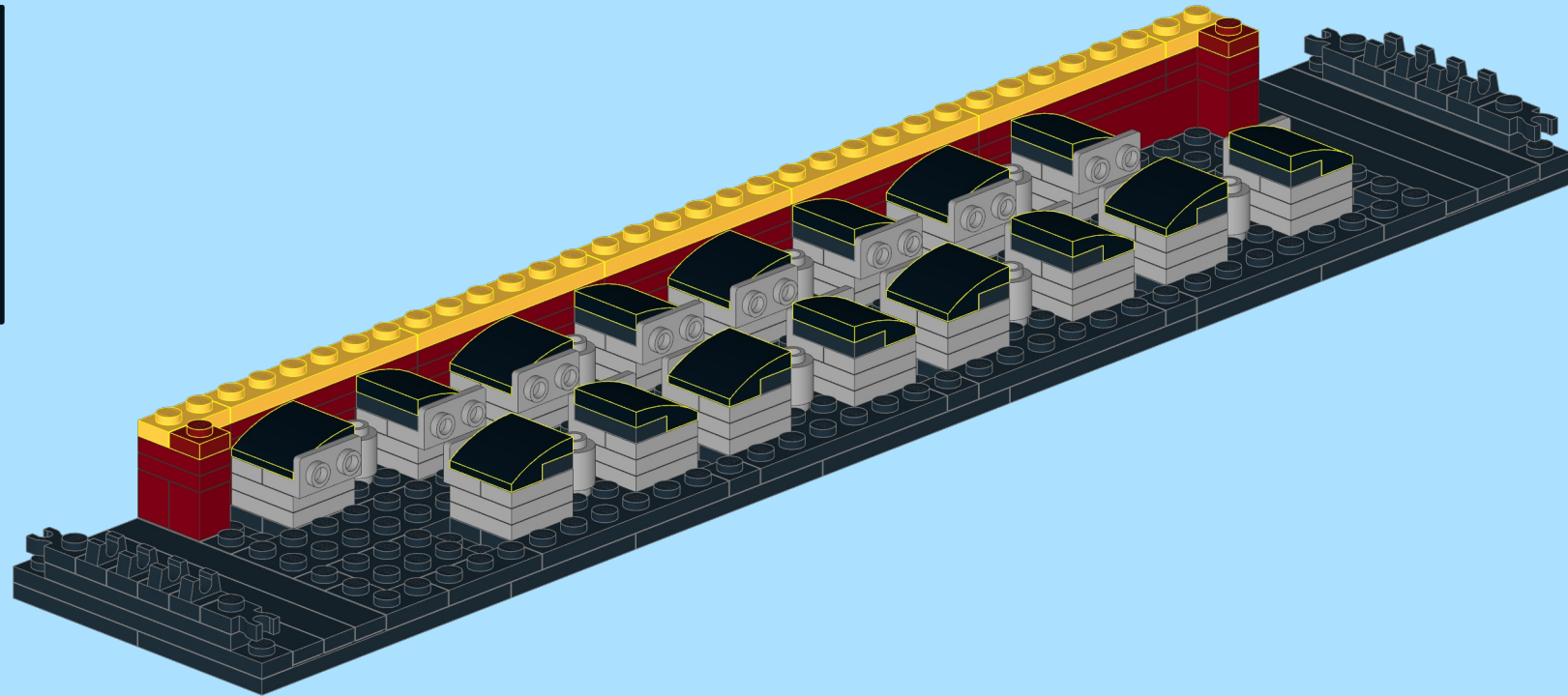
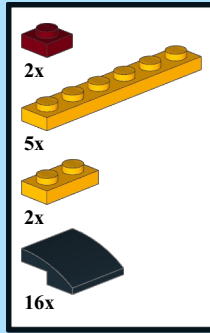

11

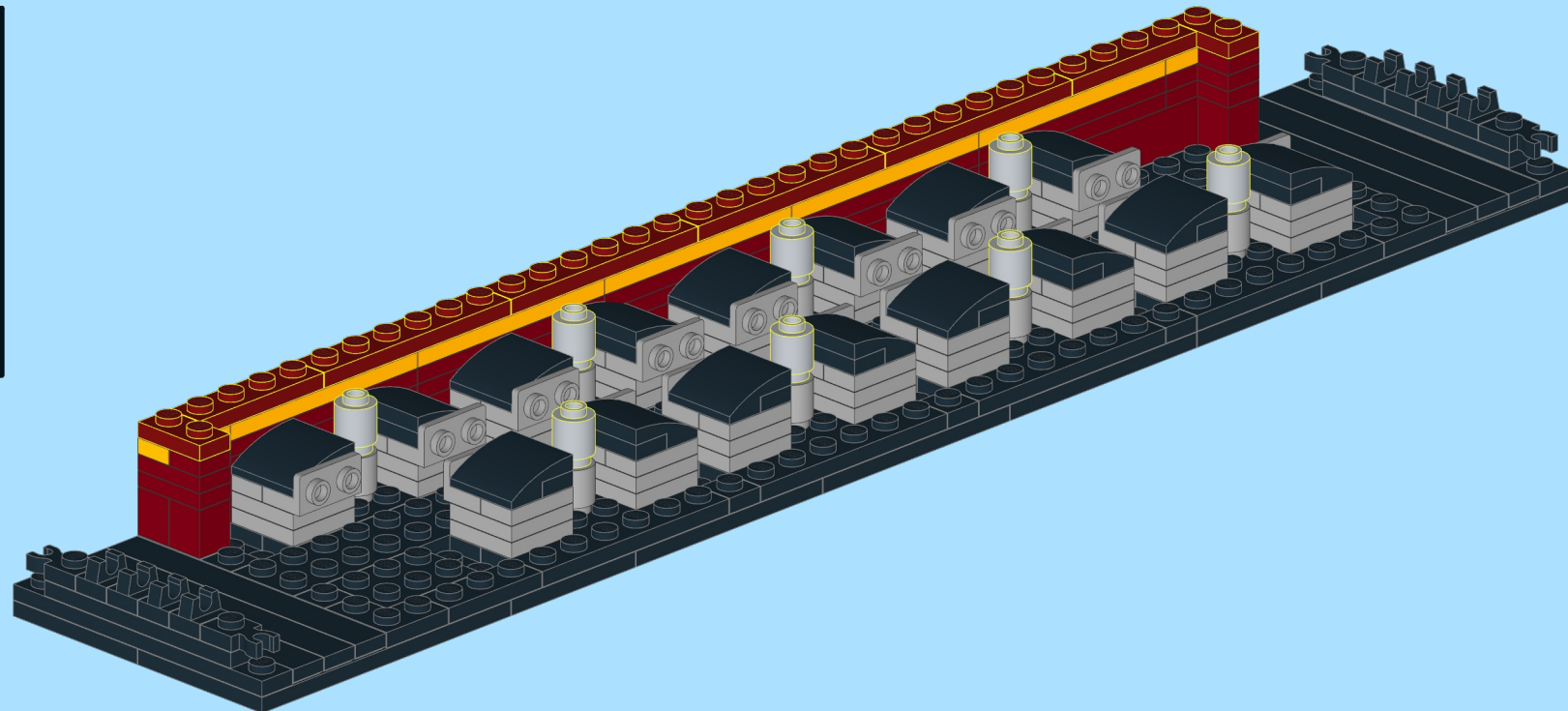
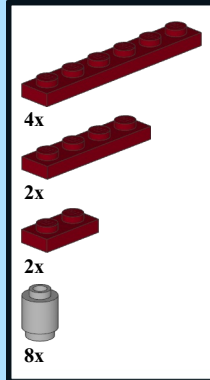

12

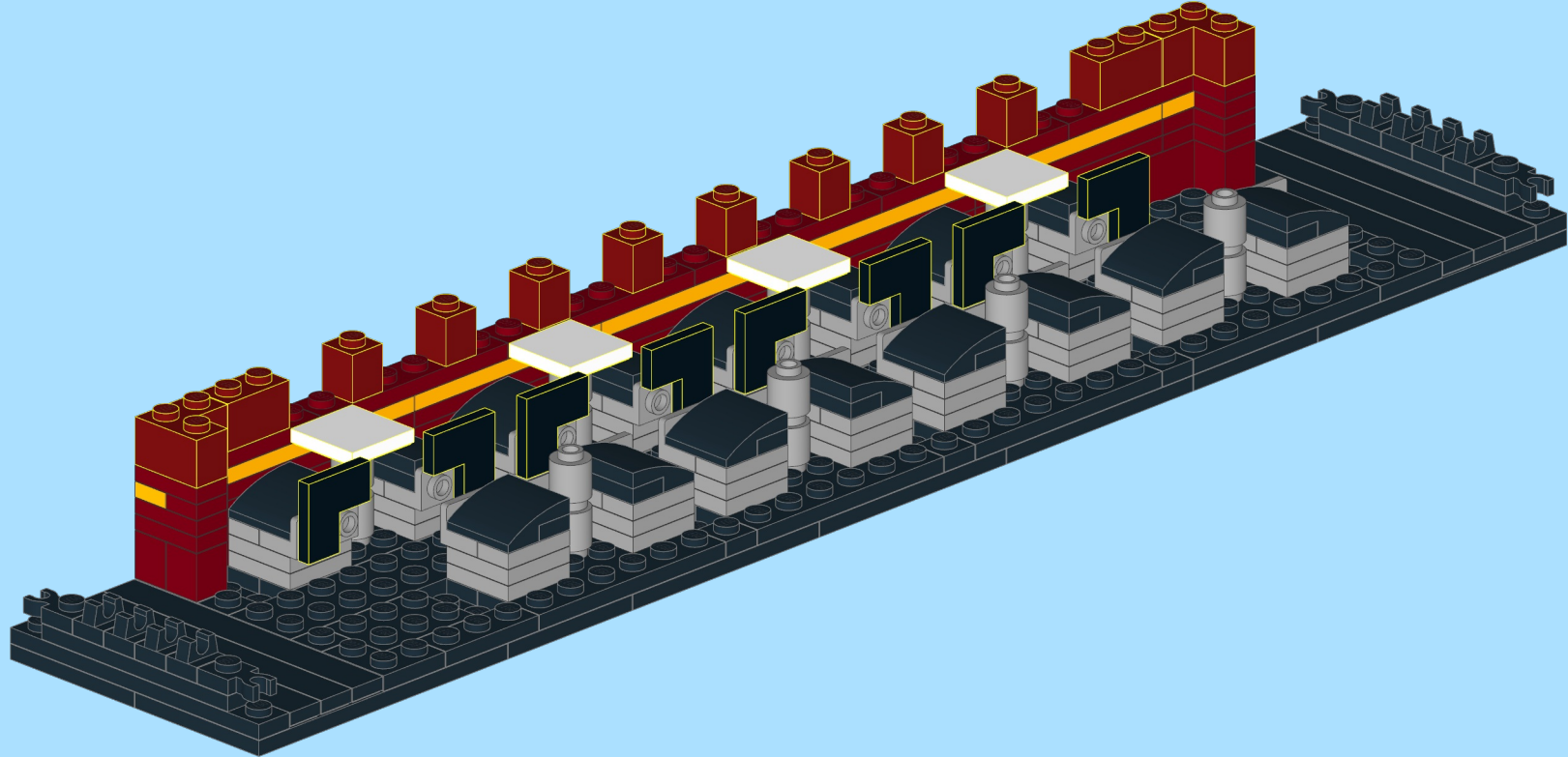
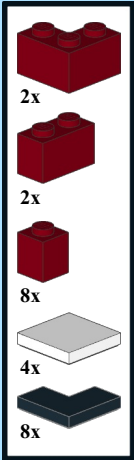

13

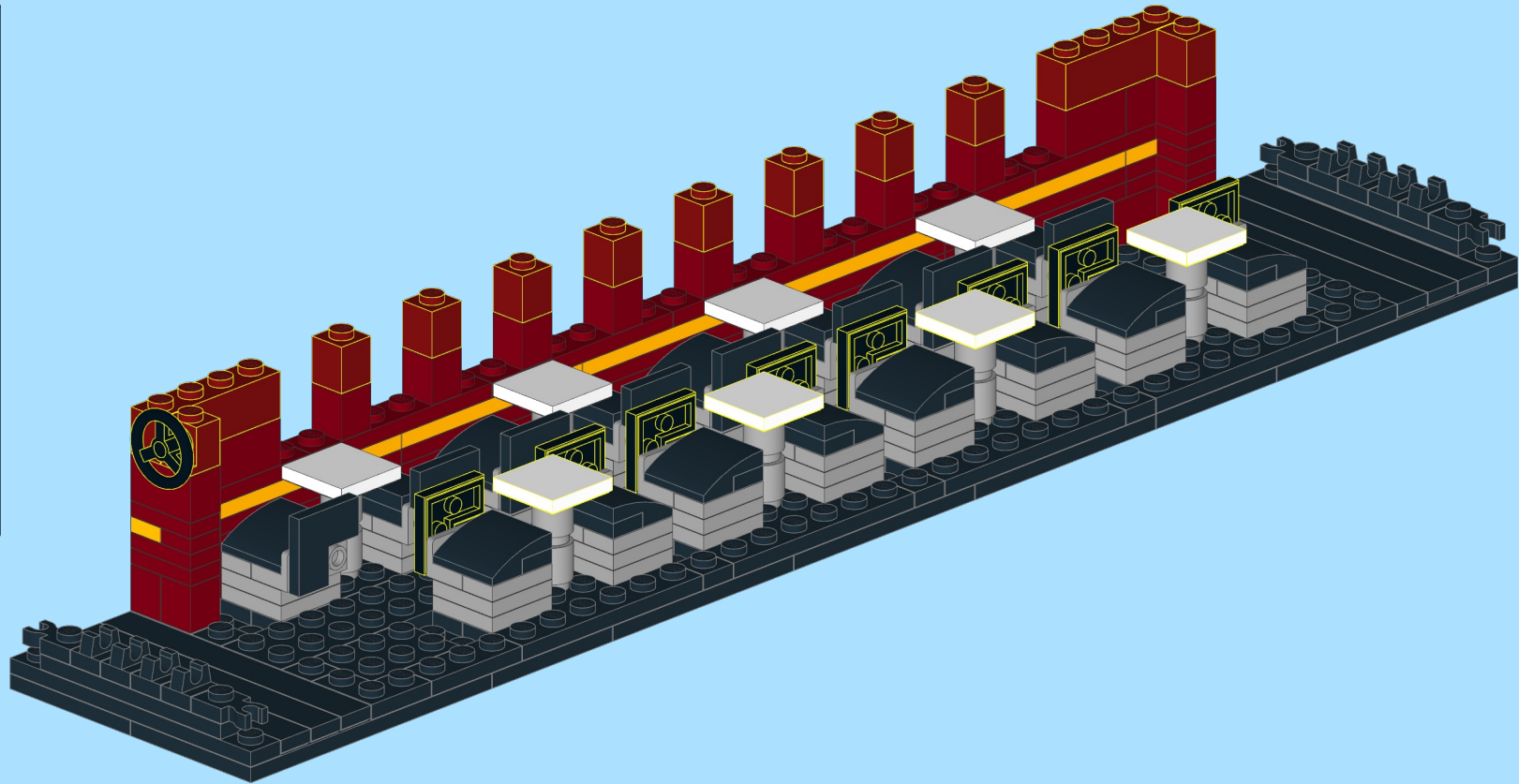
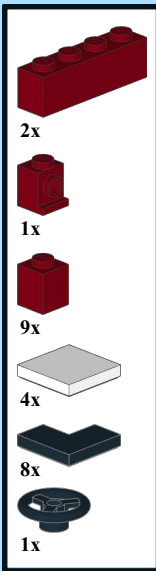

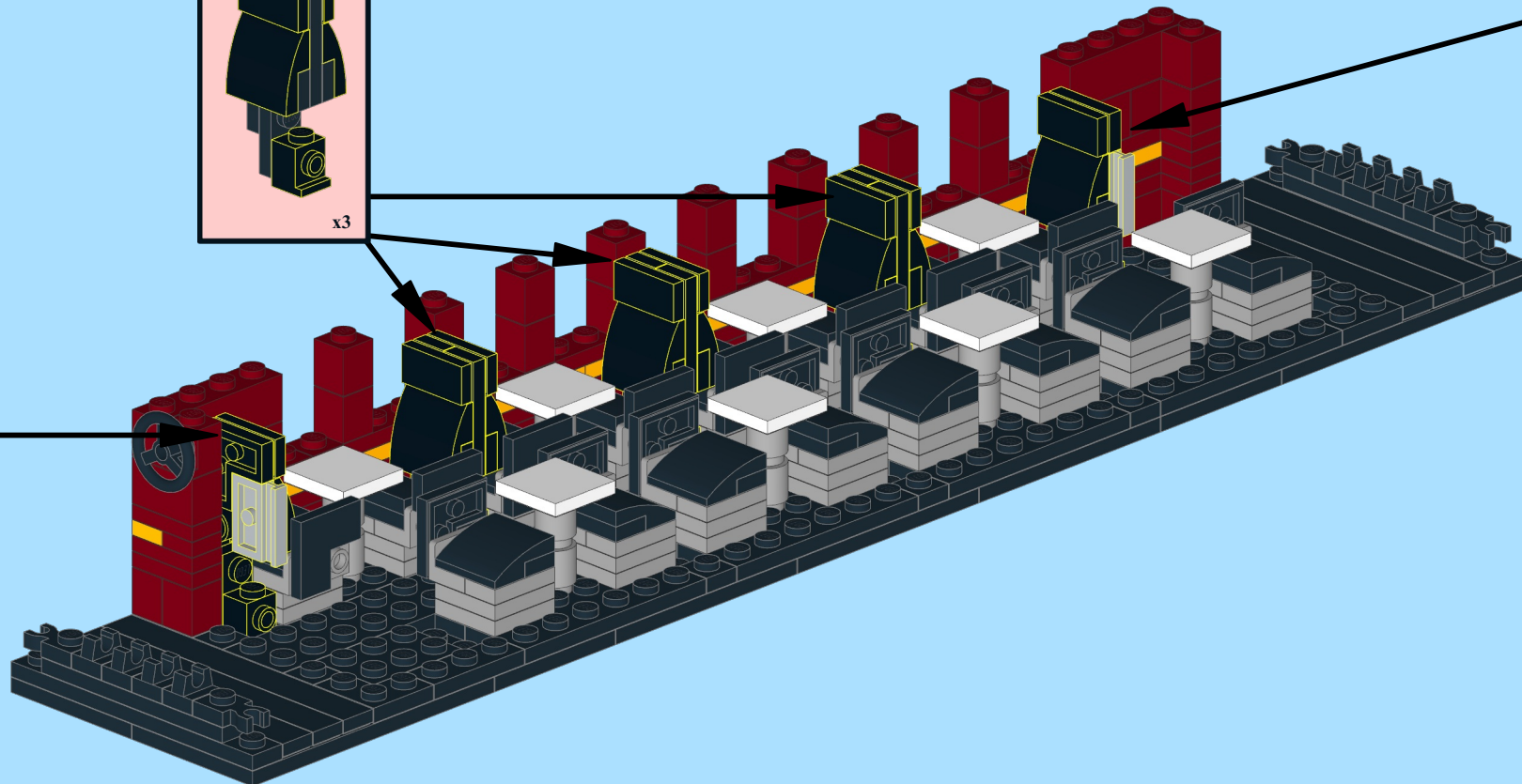
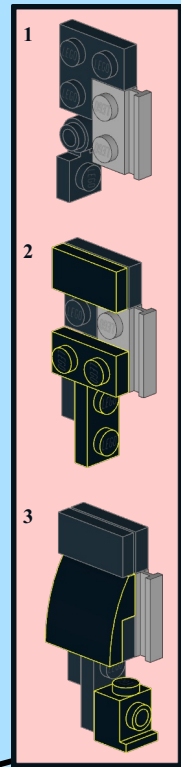
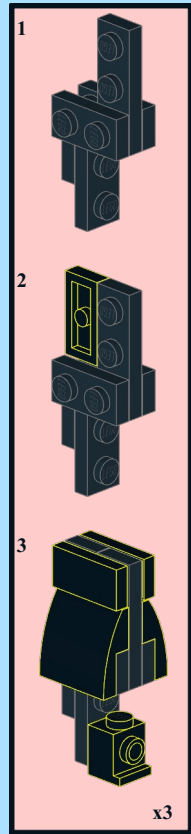
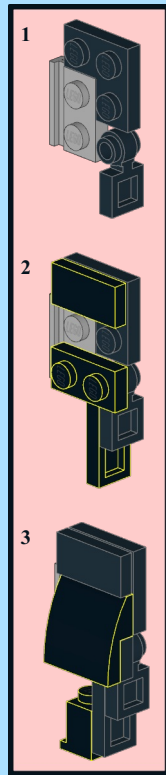
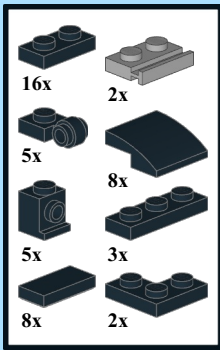

- 16x
- 2x
- 5x
- 8x
- 5x
- 3x
- 8x
- 2x

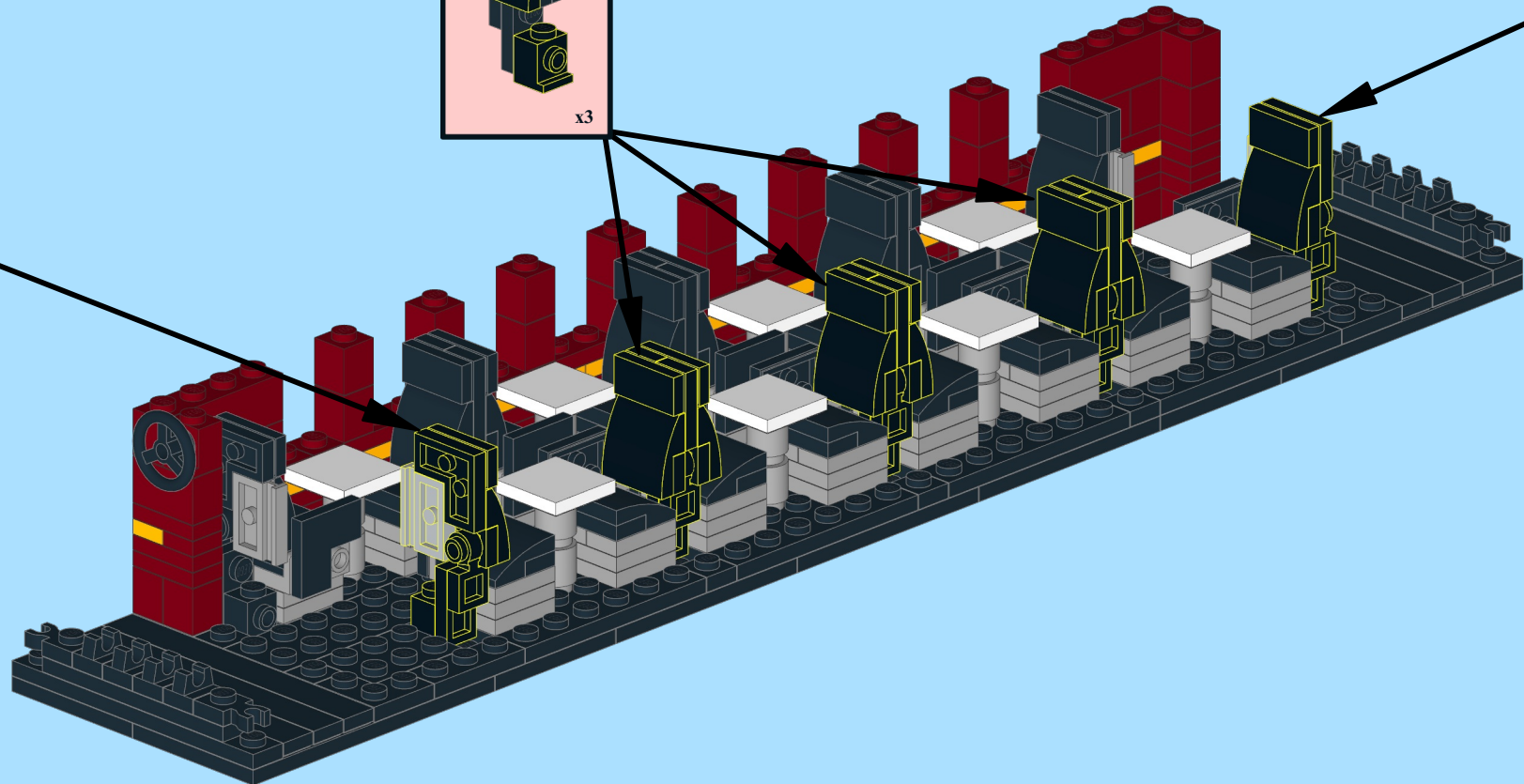
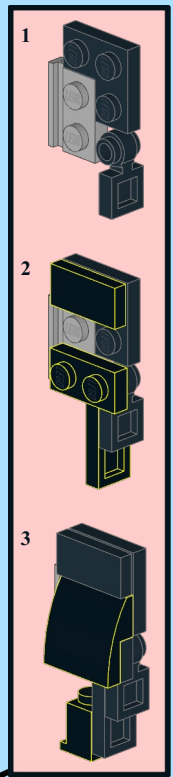
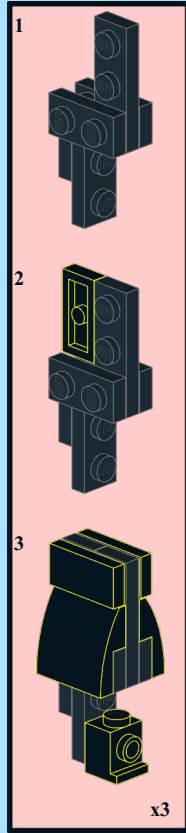
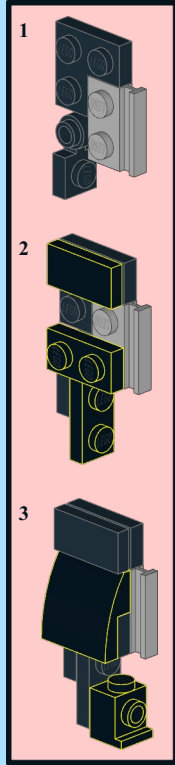

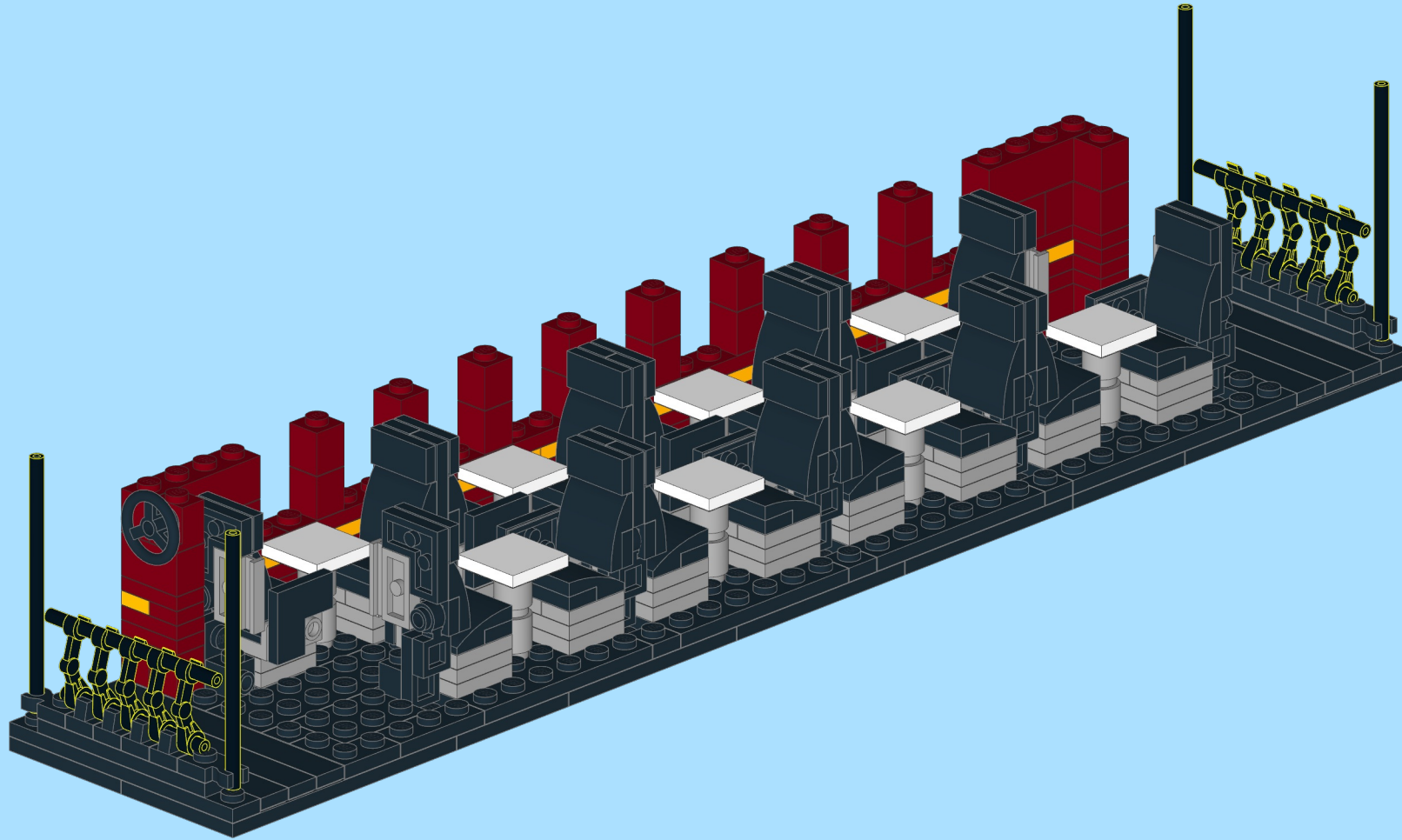
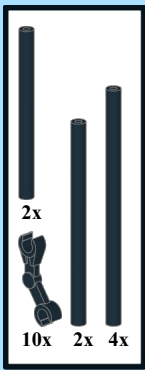

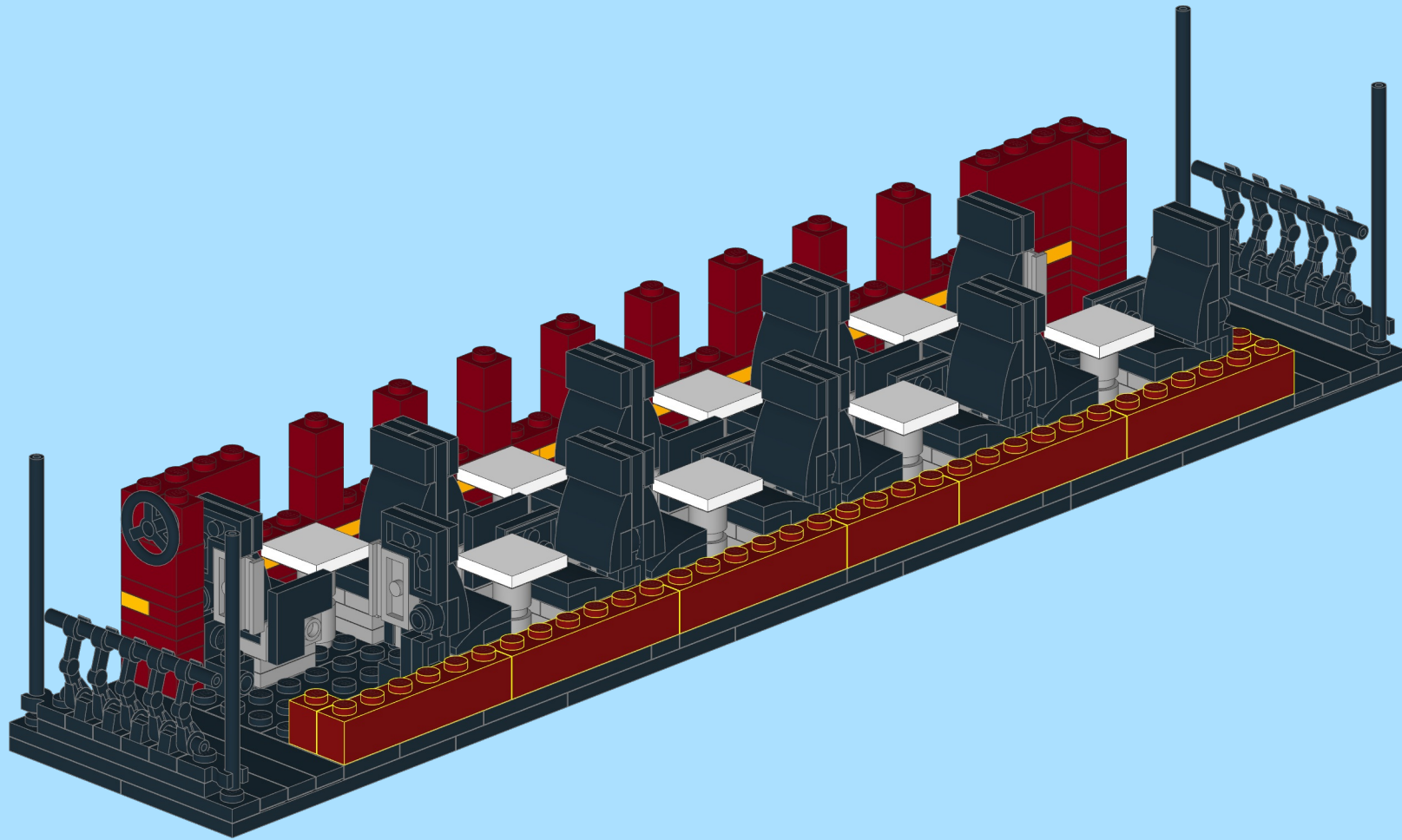
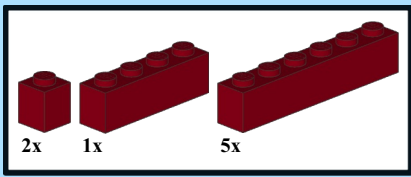

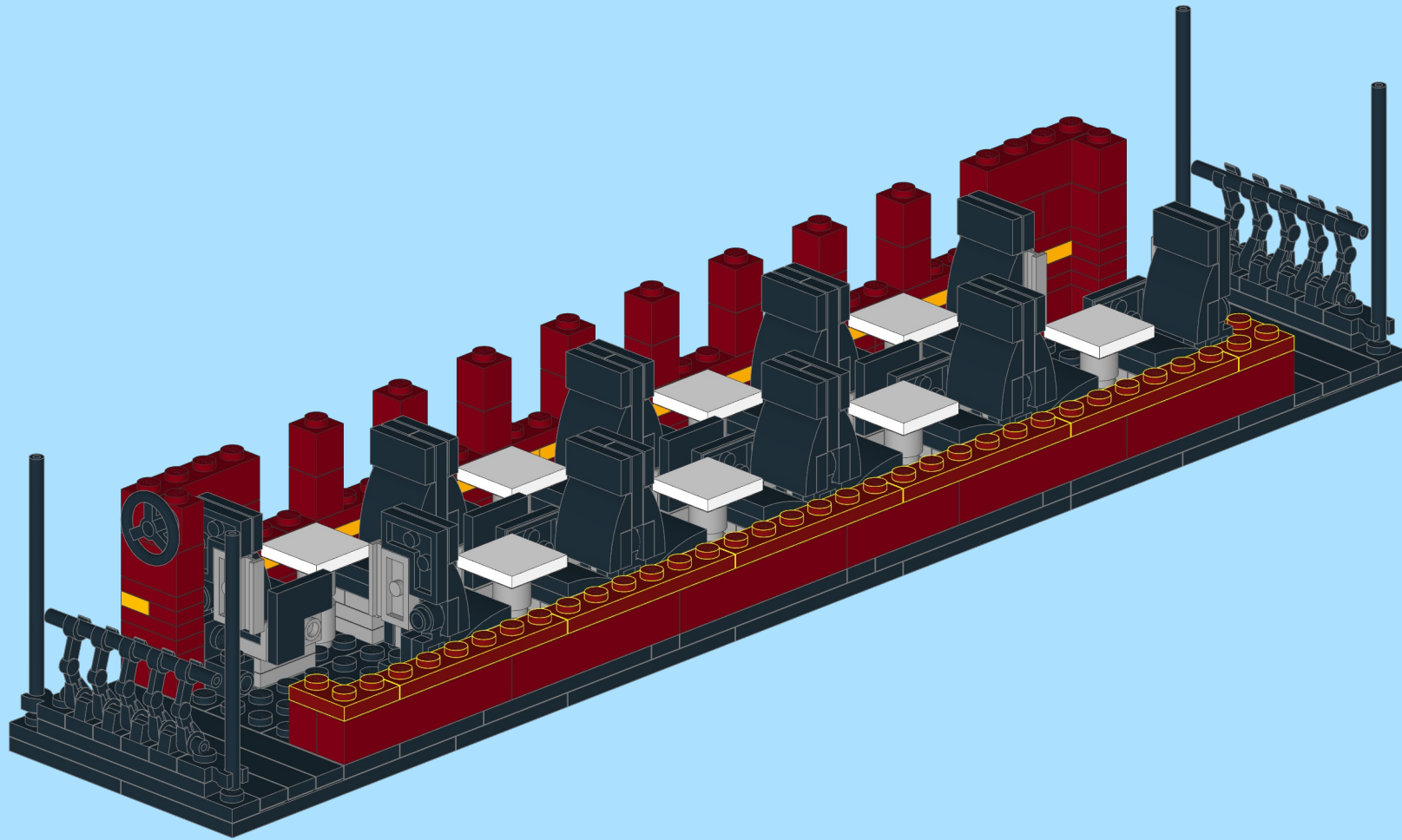
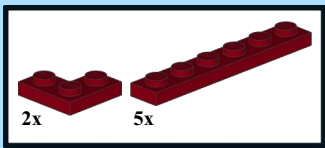

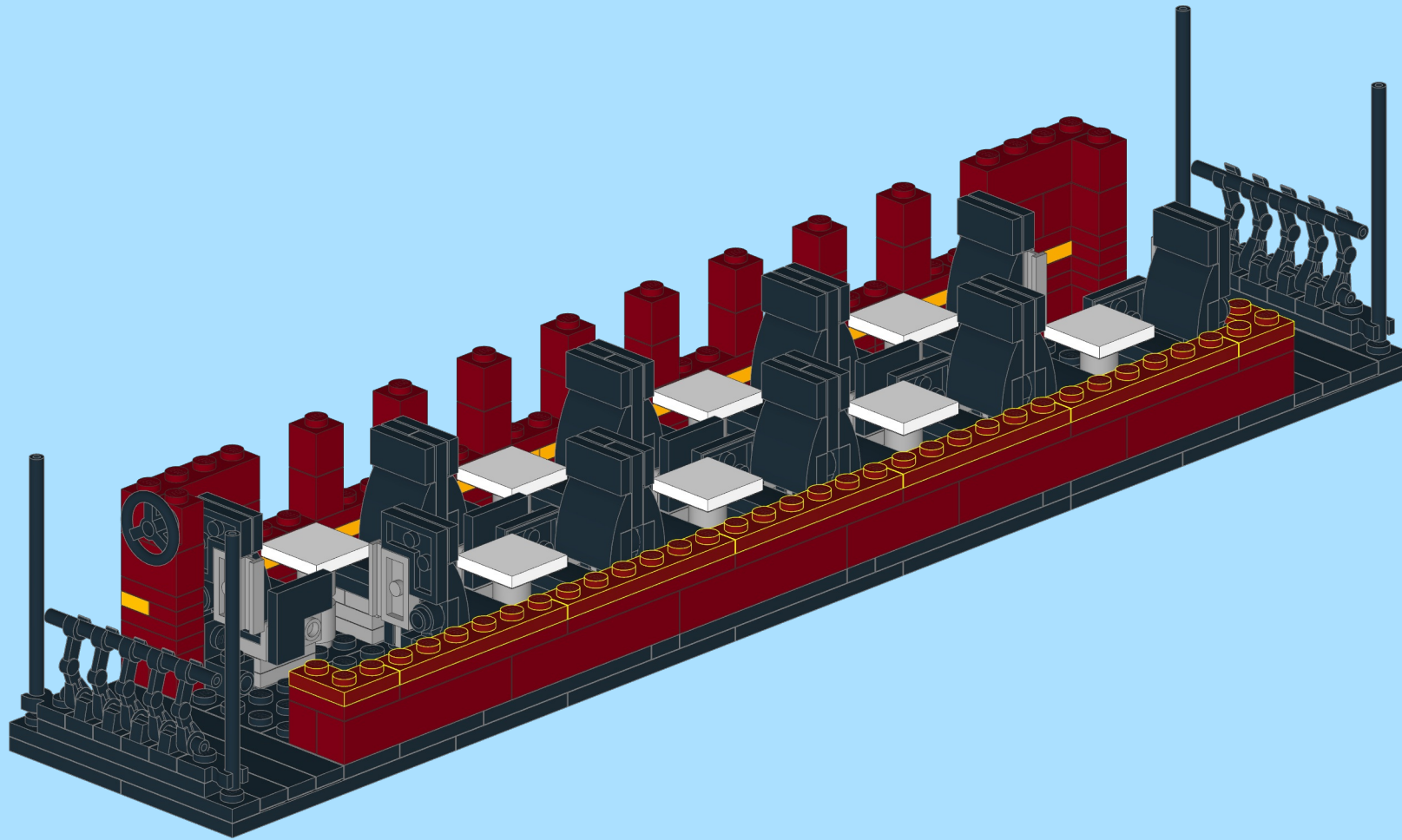
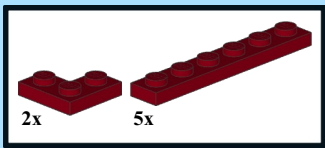

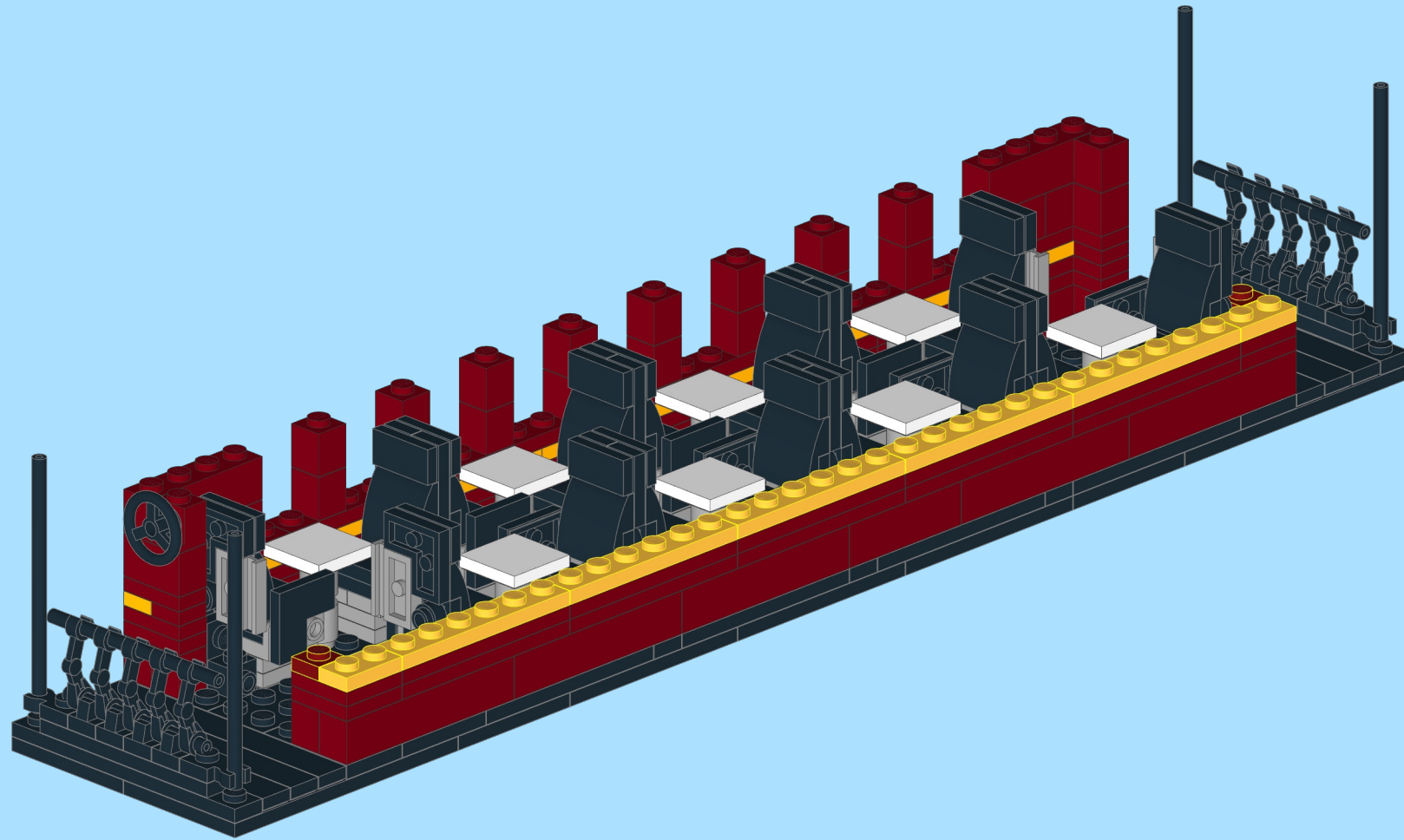
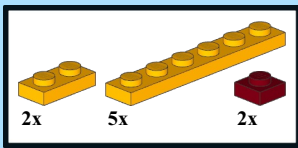

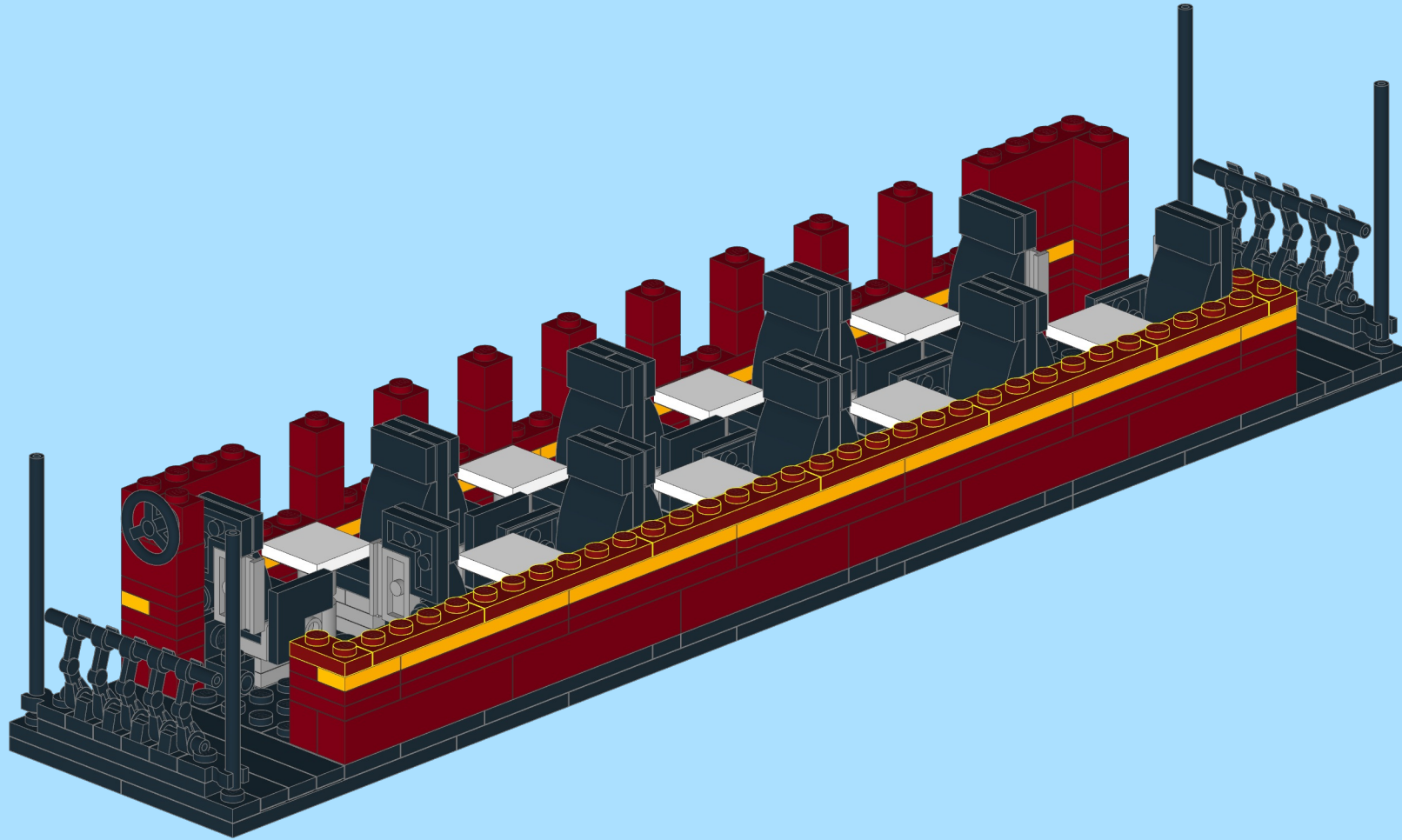
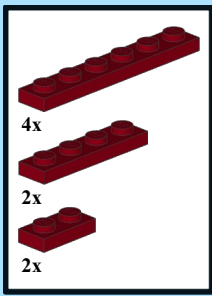

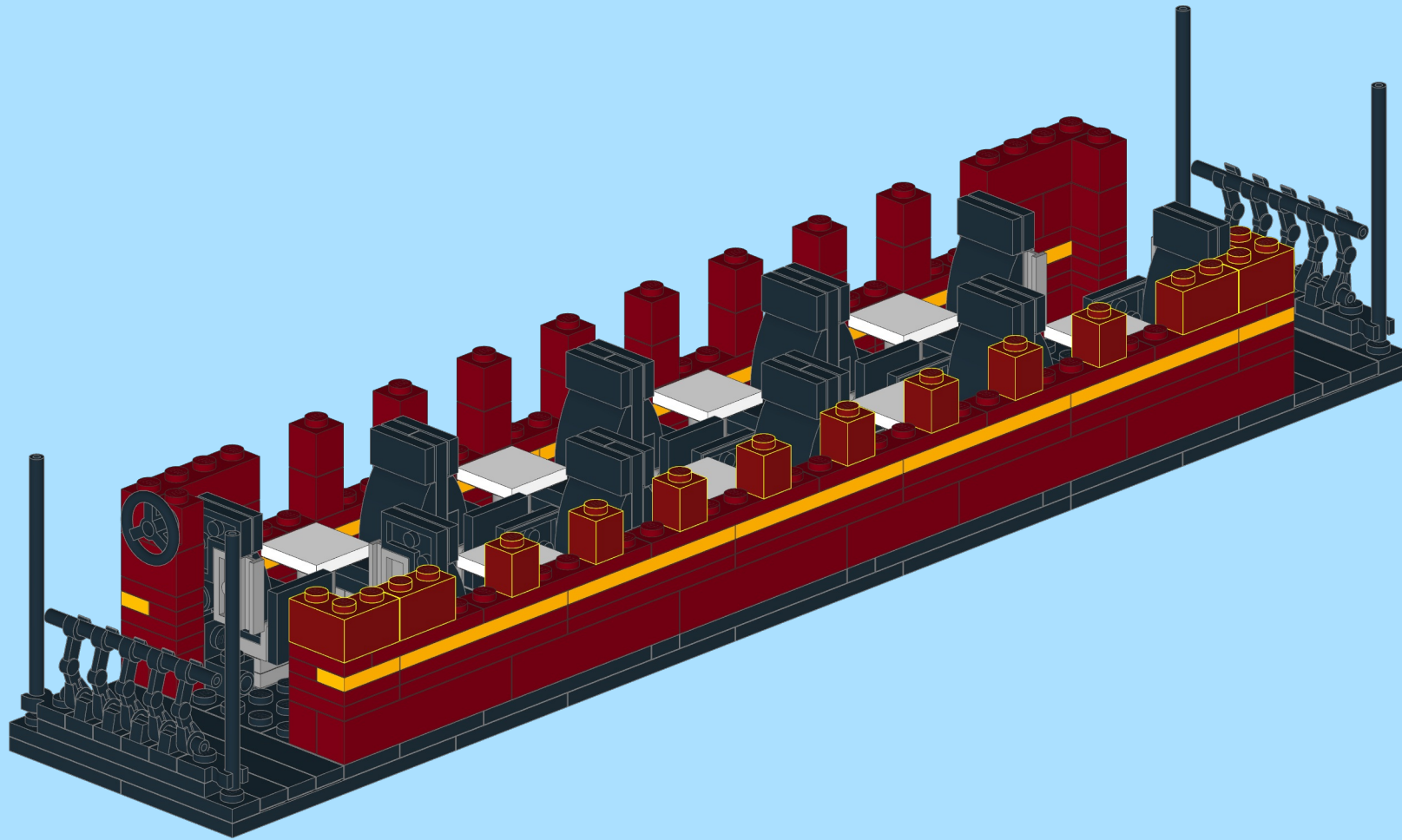
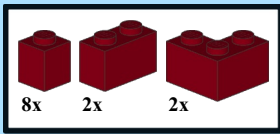

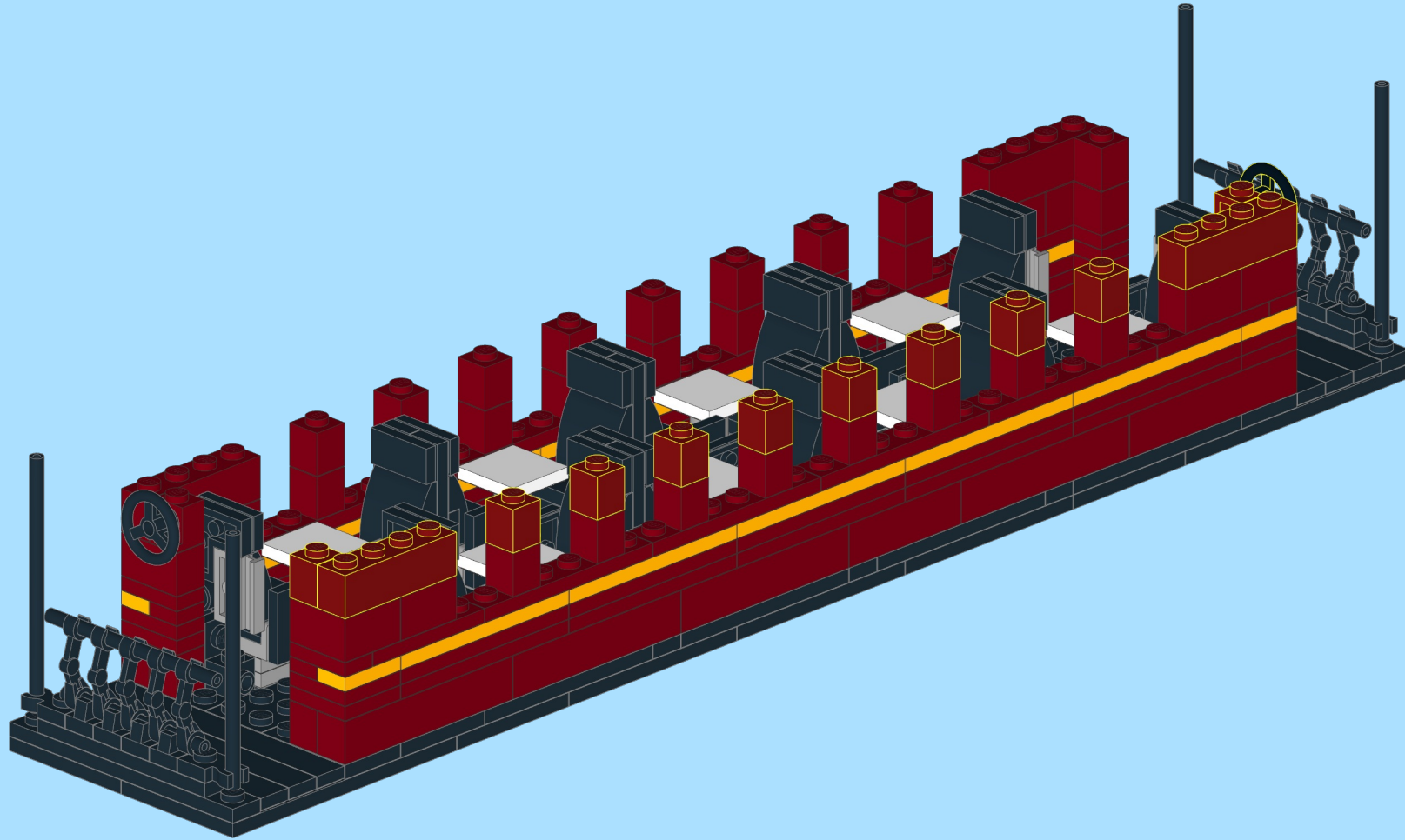
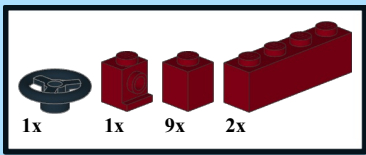

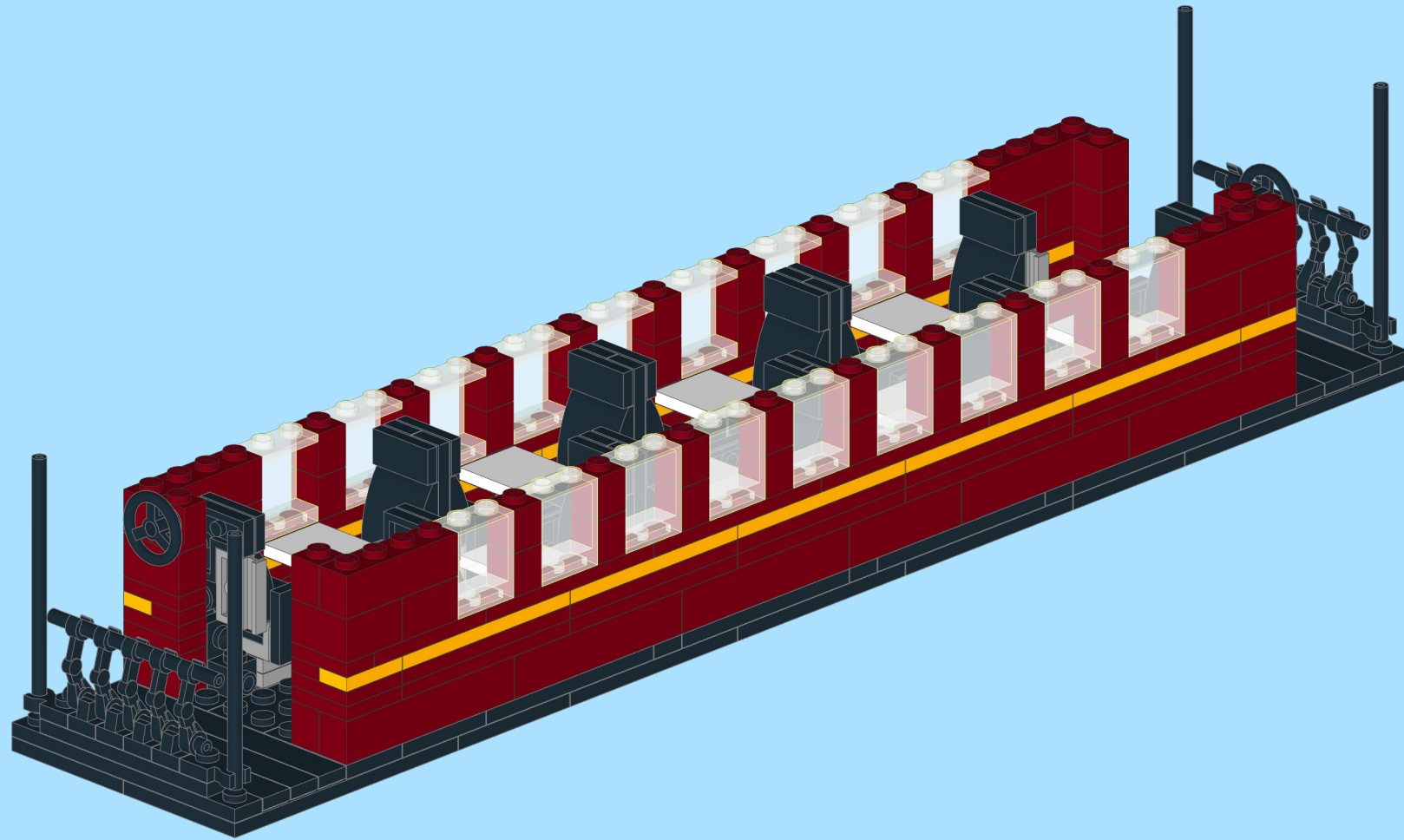
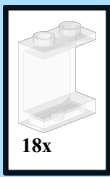

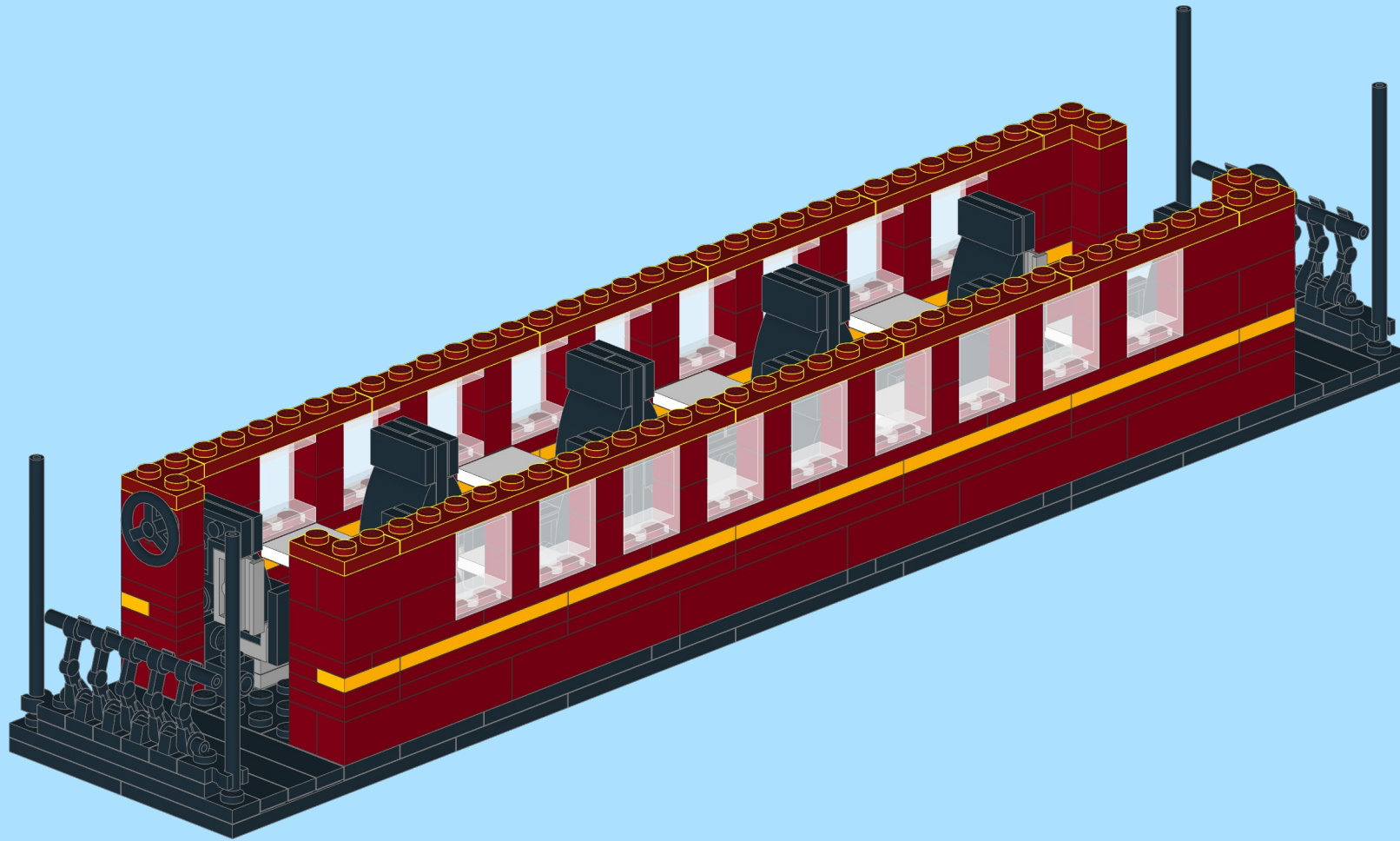
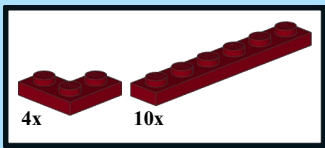

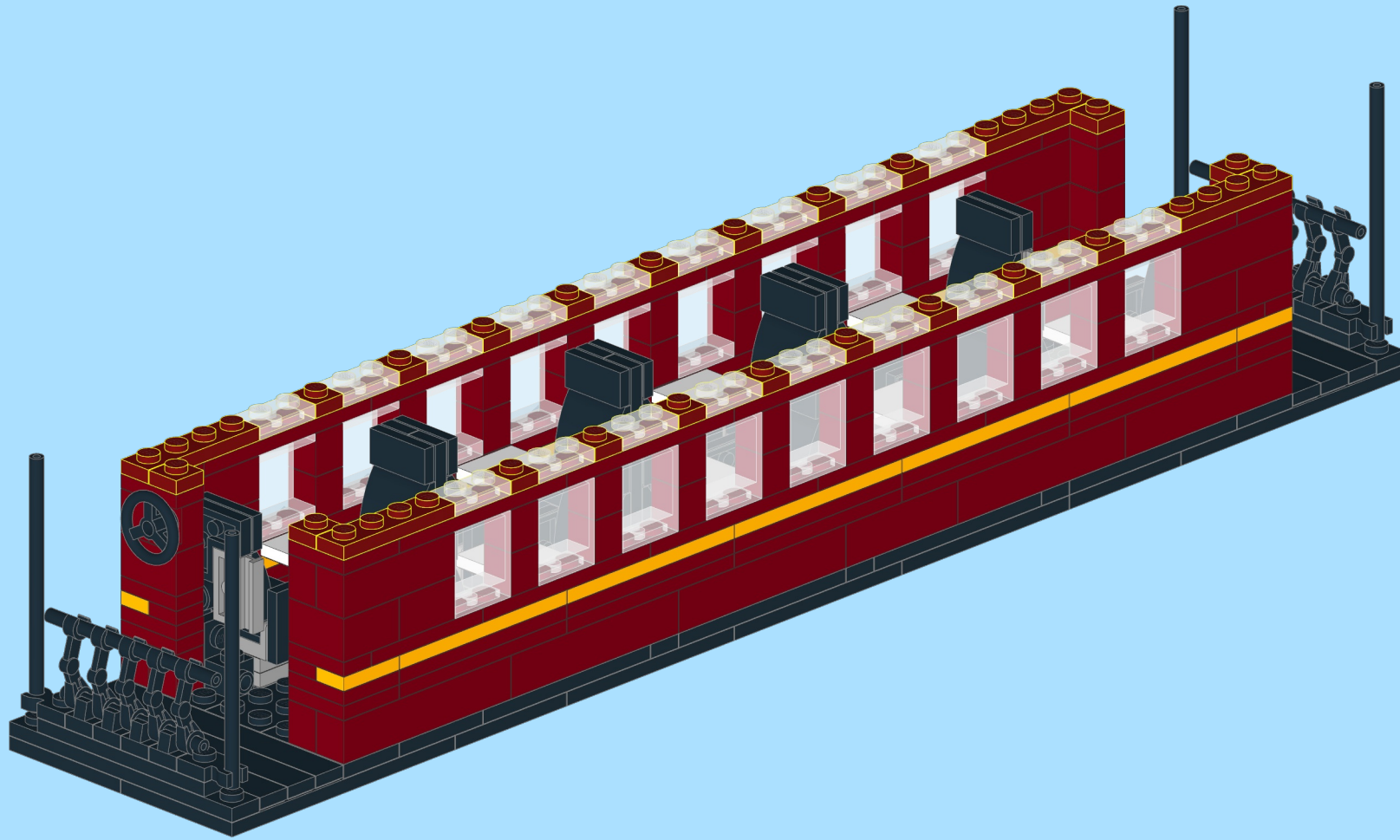
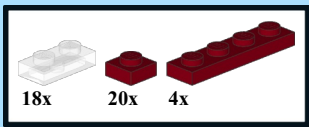

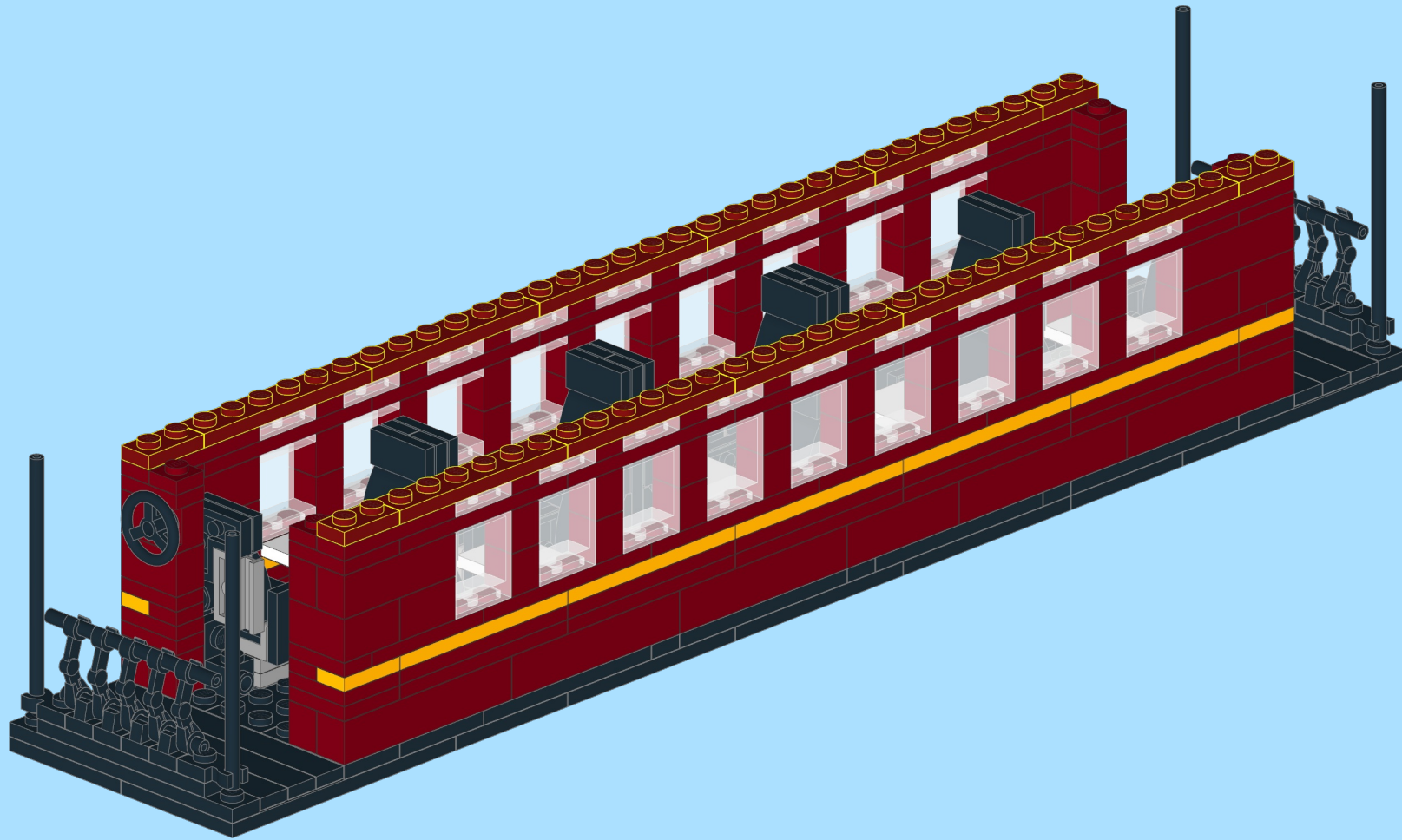
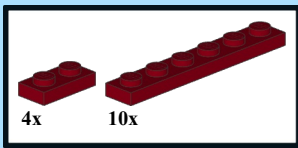

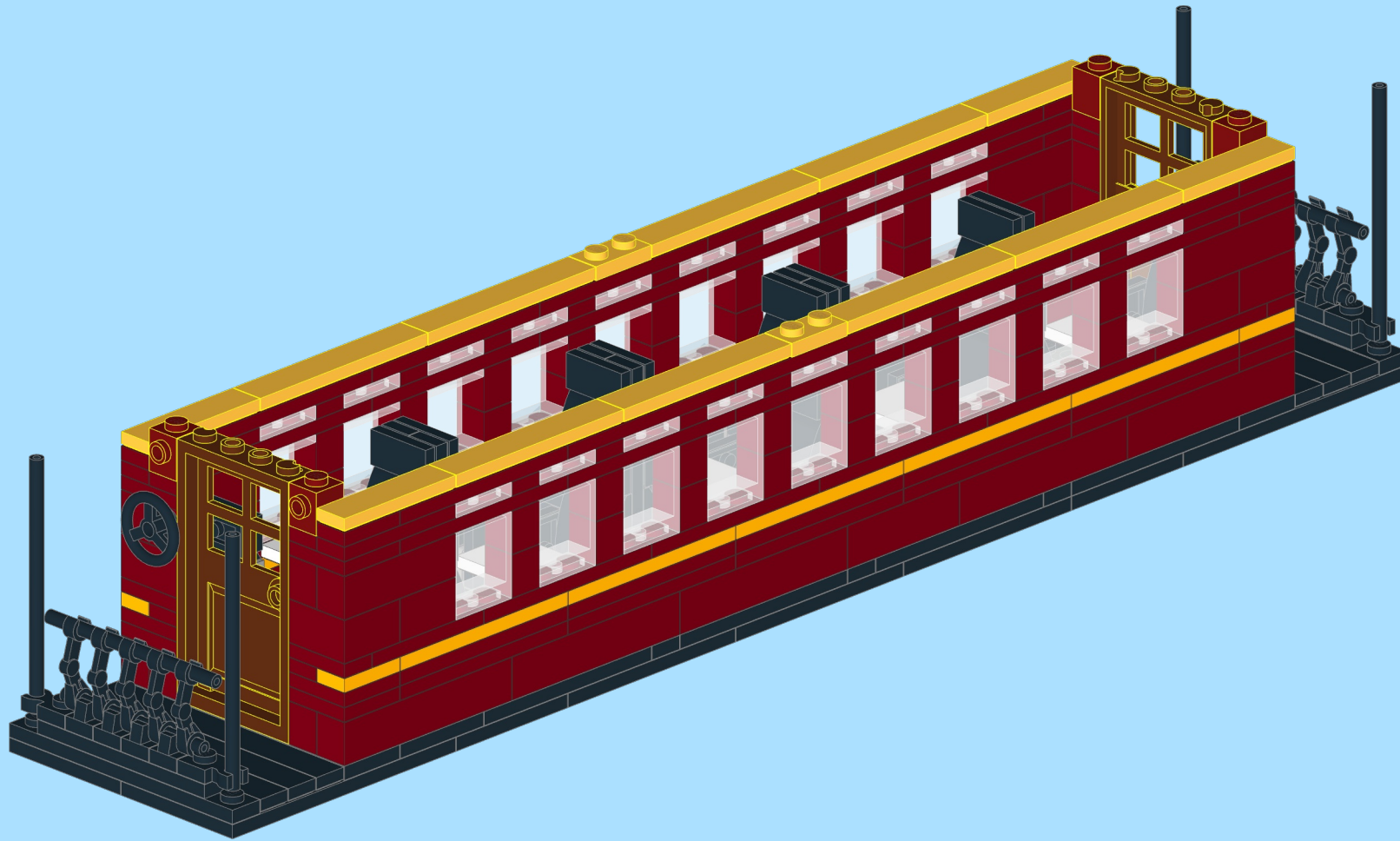
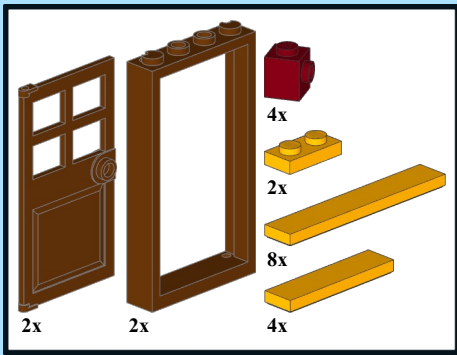

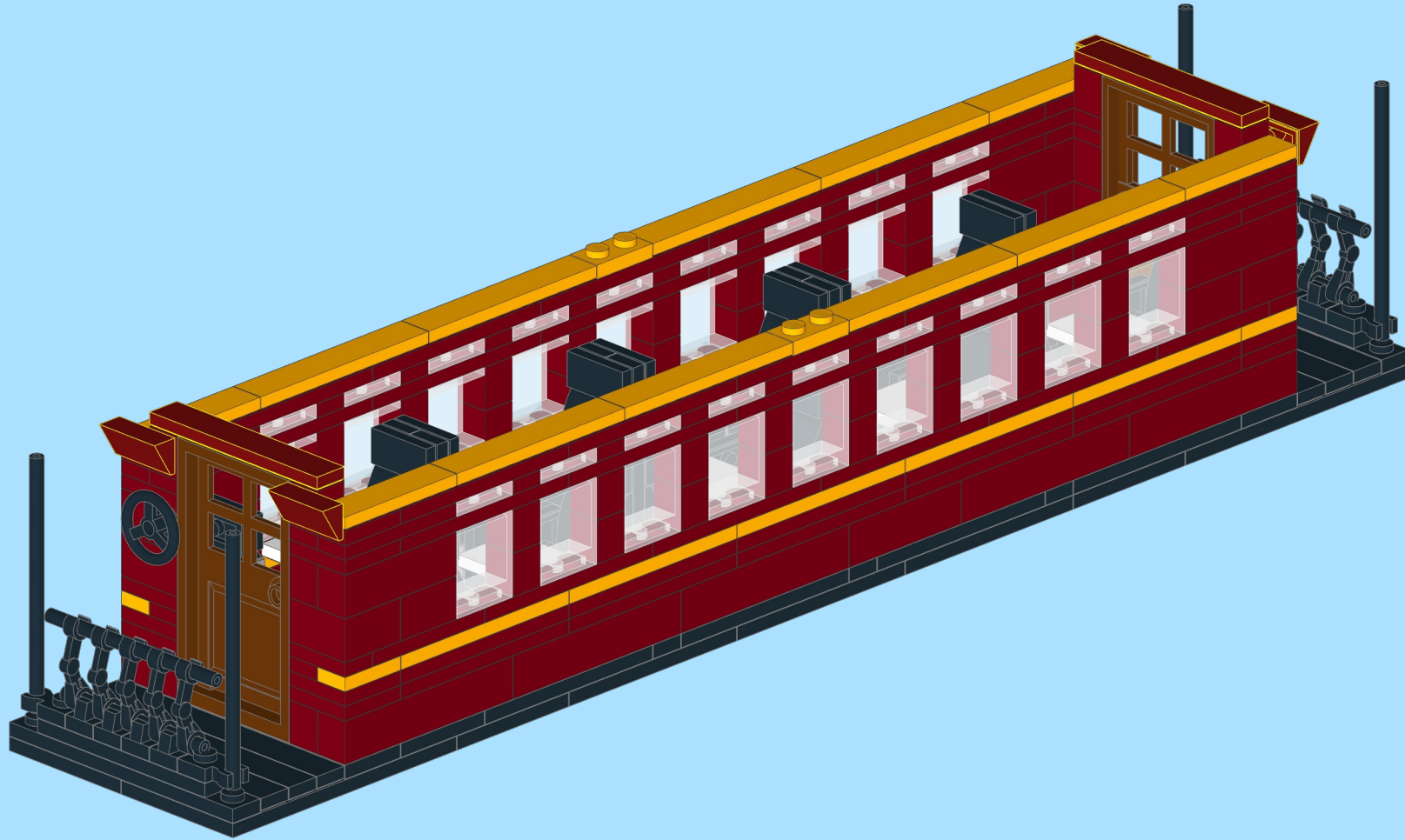
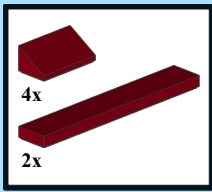

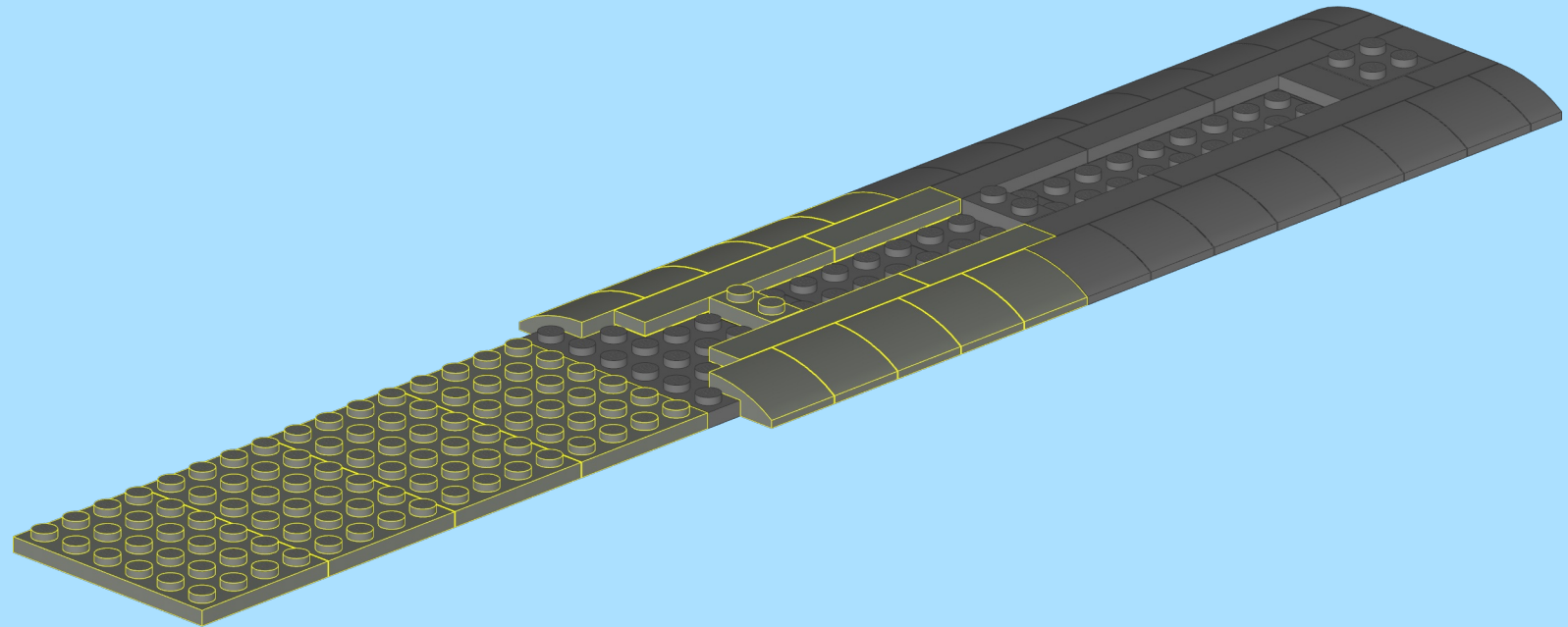
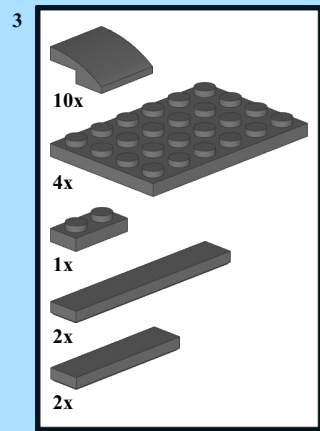
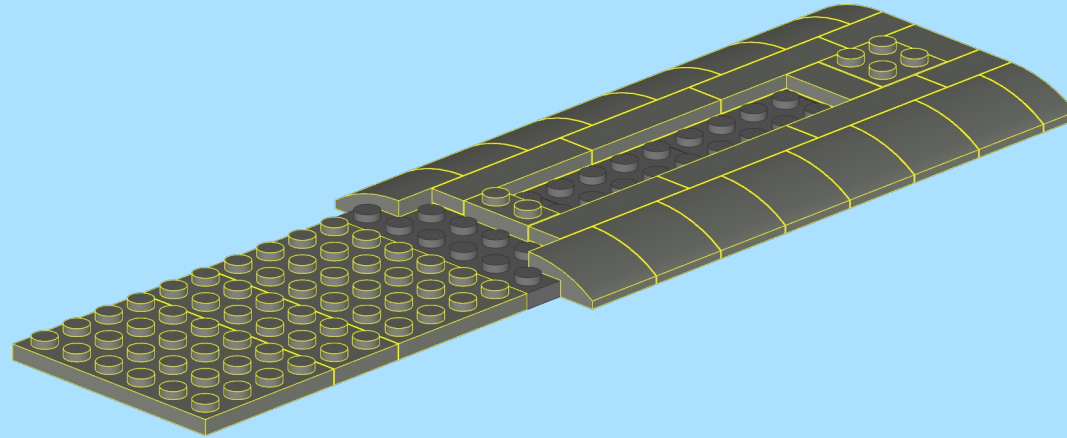
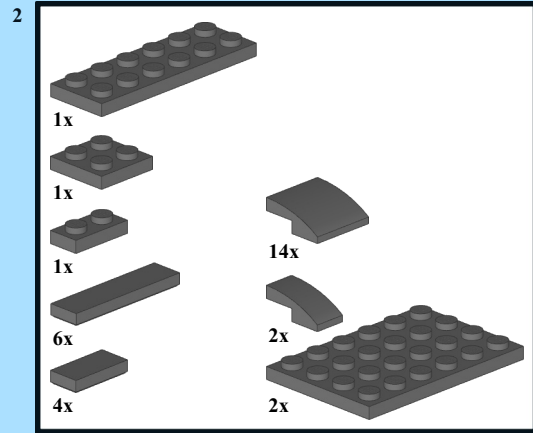
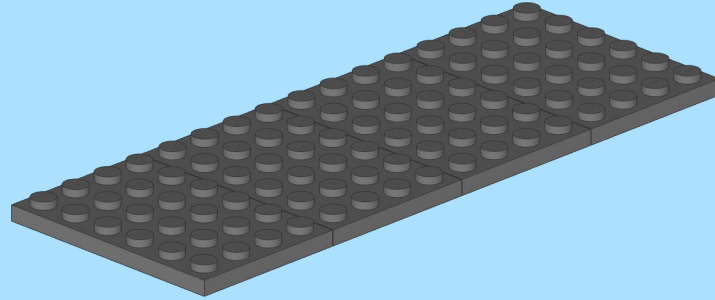
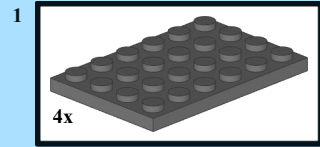

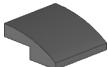
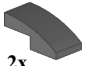
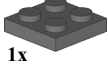





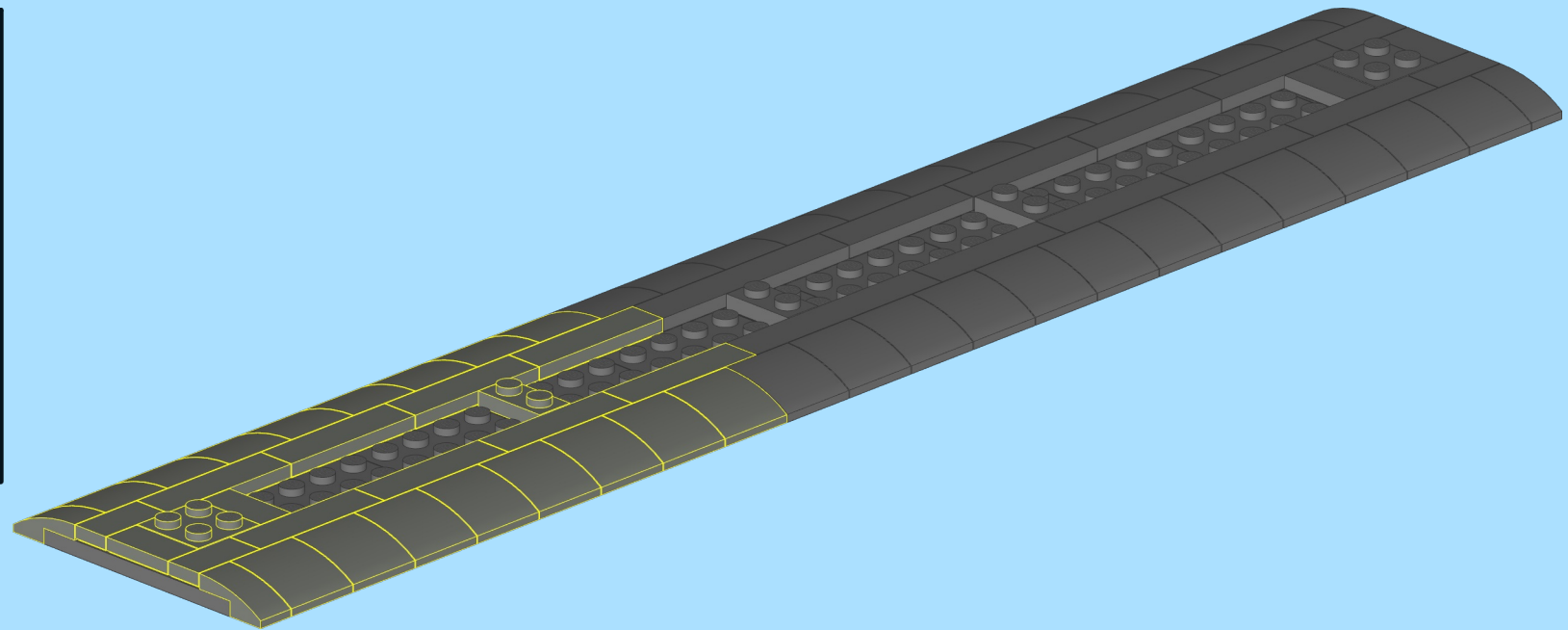







- 4
-  16x
 -  2x
 -  1x
 -  1x
 -  8x
 -  4x

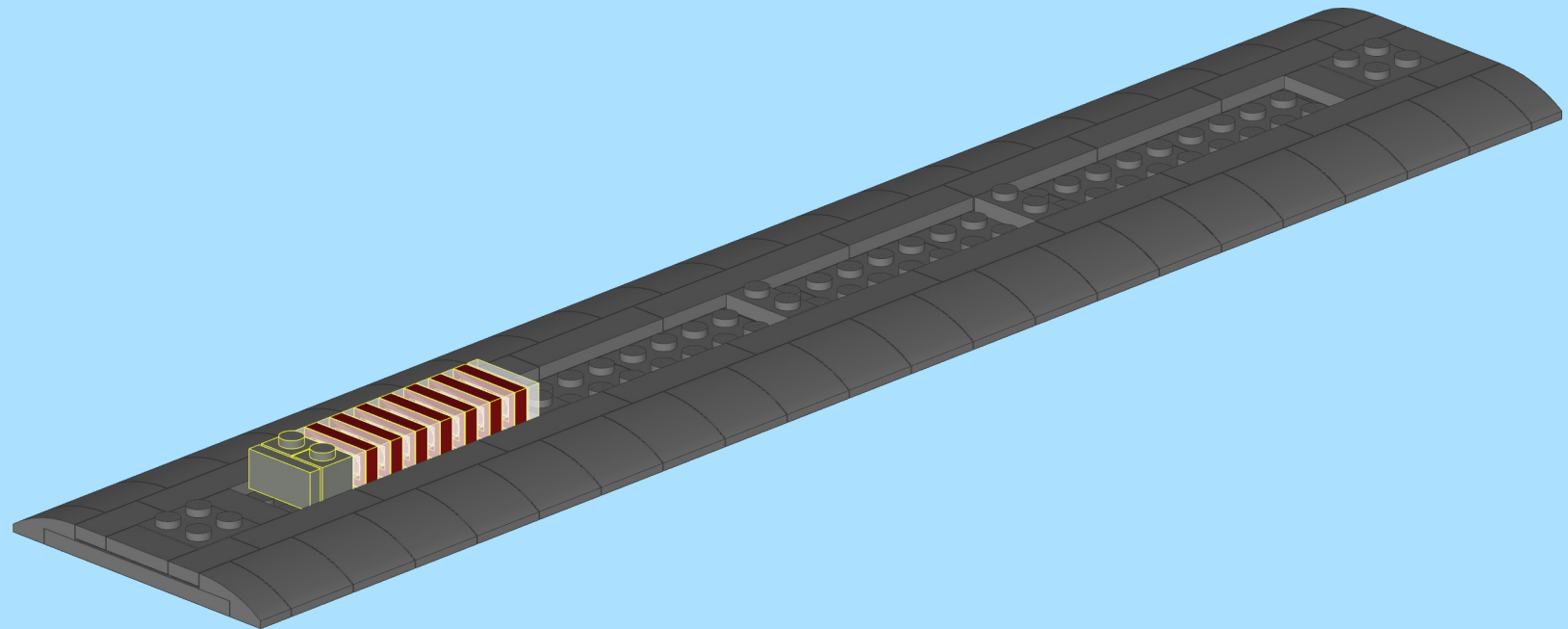



- 5
-  7x
 -  2x
 -  1x
 -  7x
 -  1x



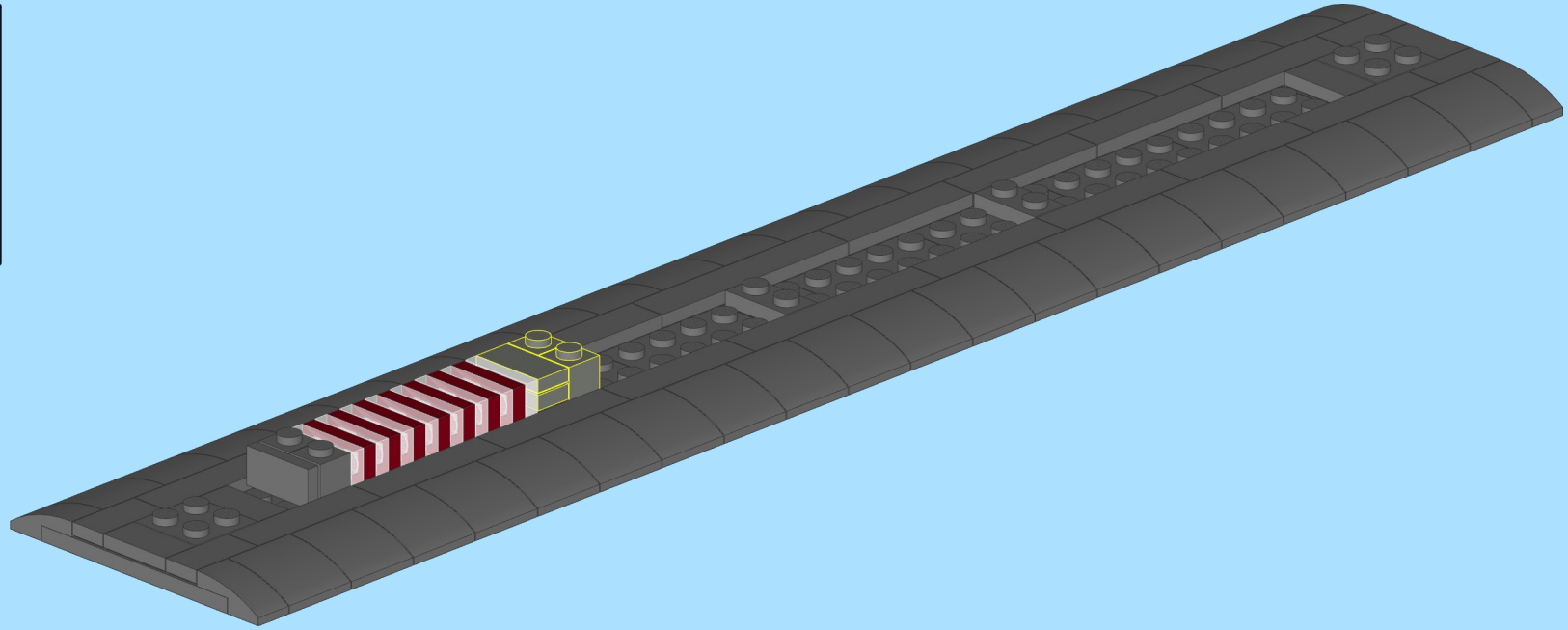

- 6
- 1x 
 - 2x 
 - 1x 



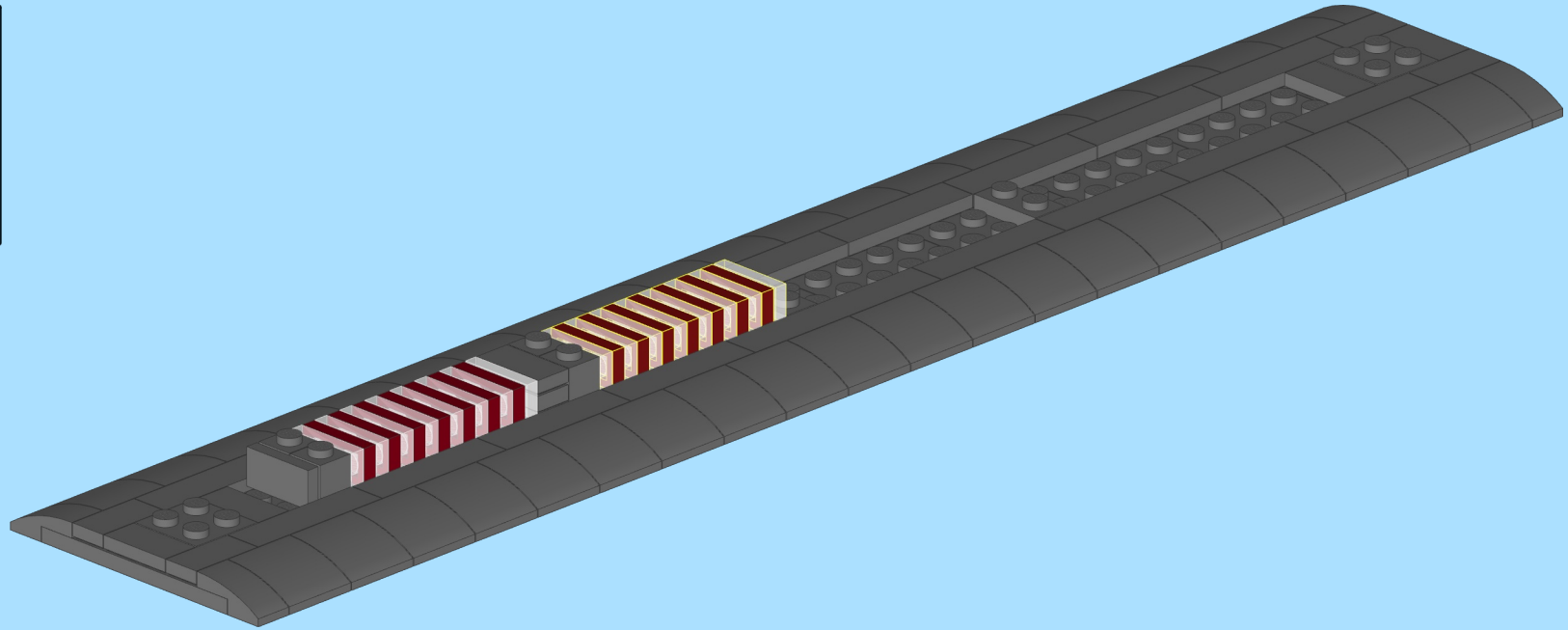

- 7
- 7x 
 - 7x 
 - 1x 

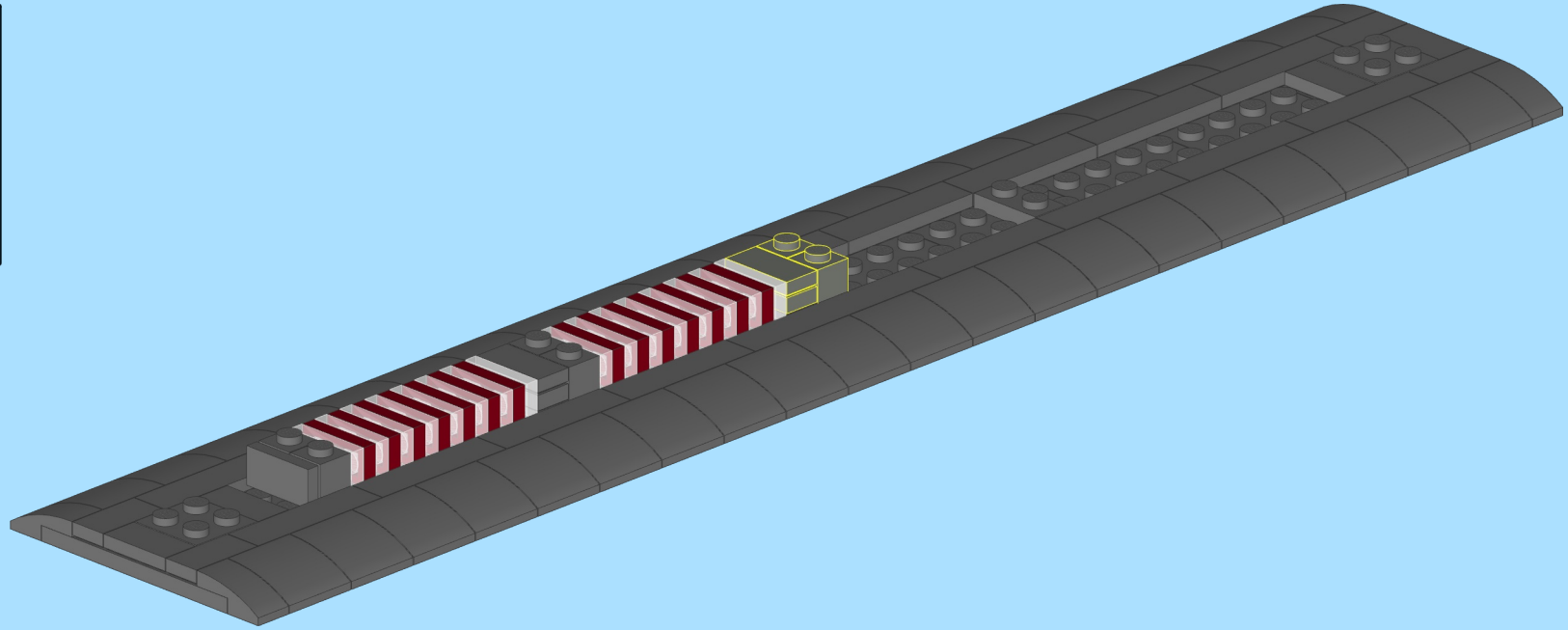

- 8
-  1x
 -  2x
 -  1x



- 9
-  7x
 -  7x
 -  1x

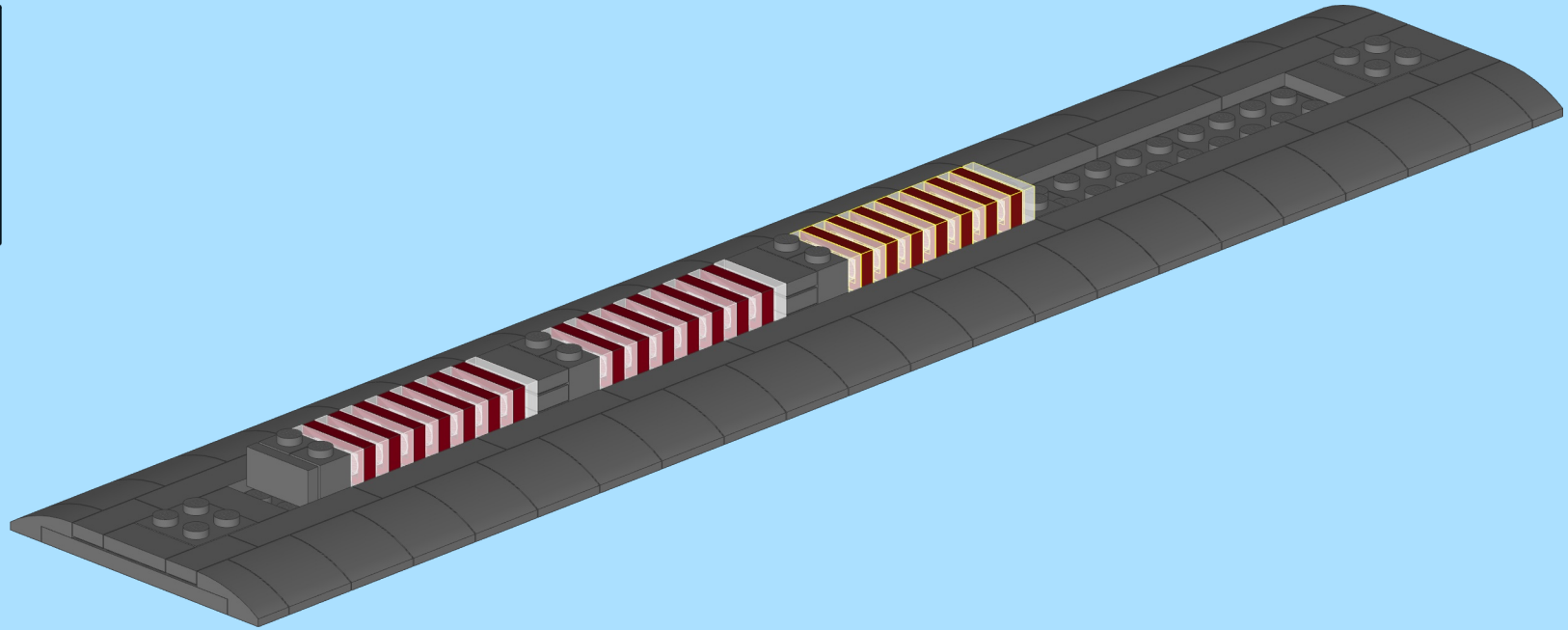

10

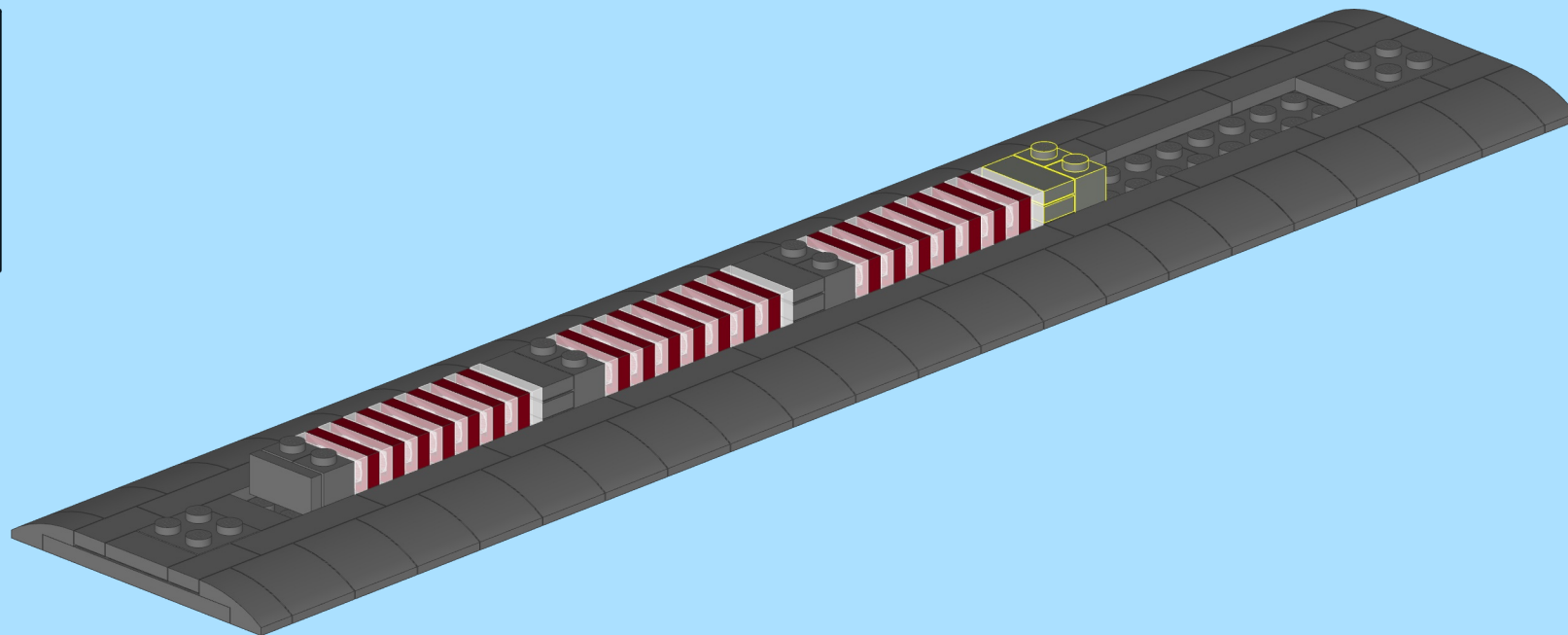
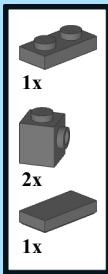

11

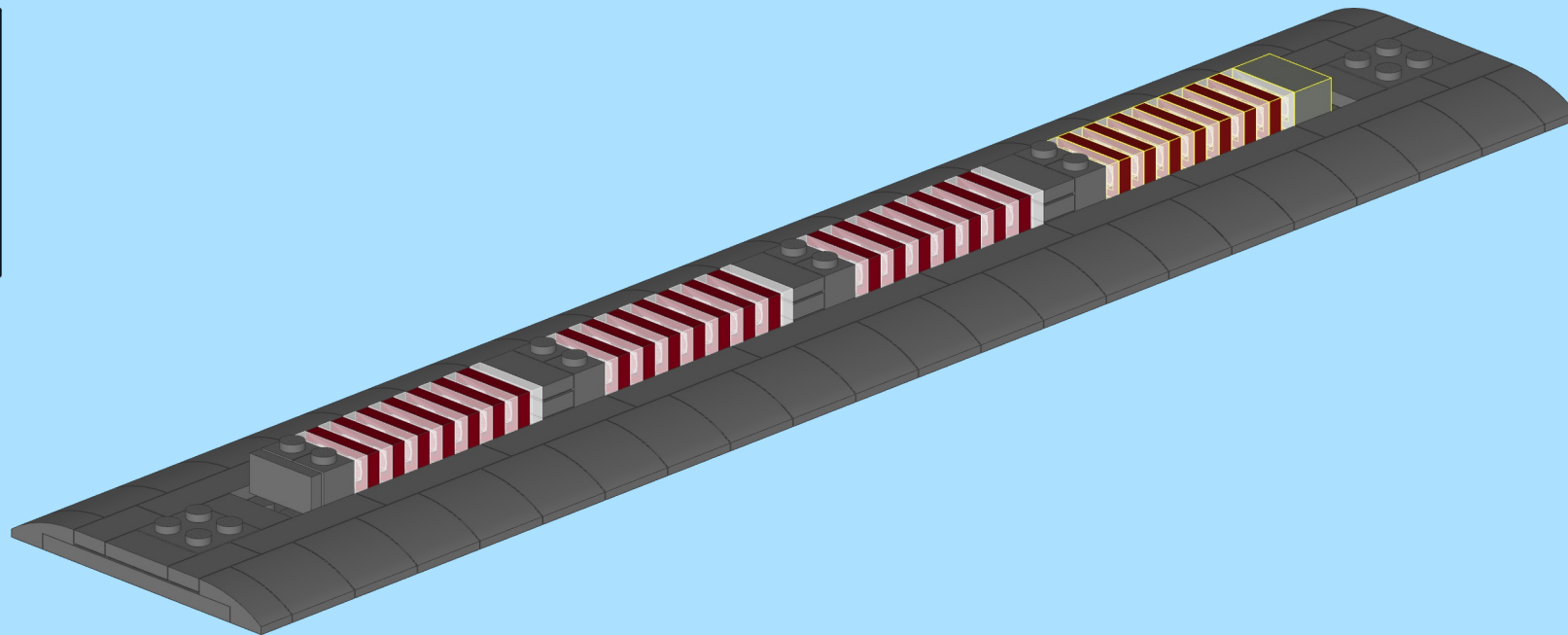
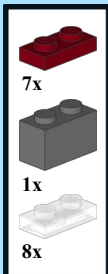

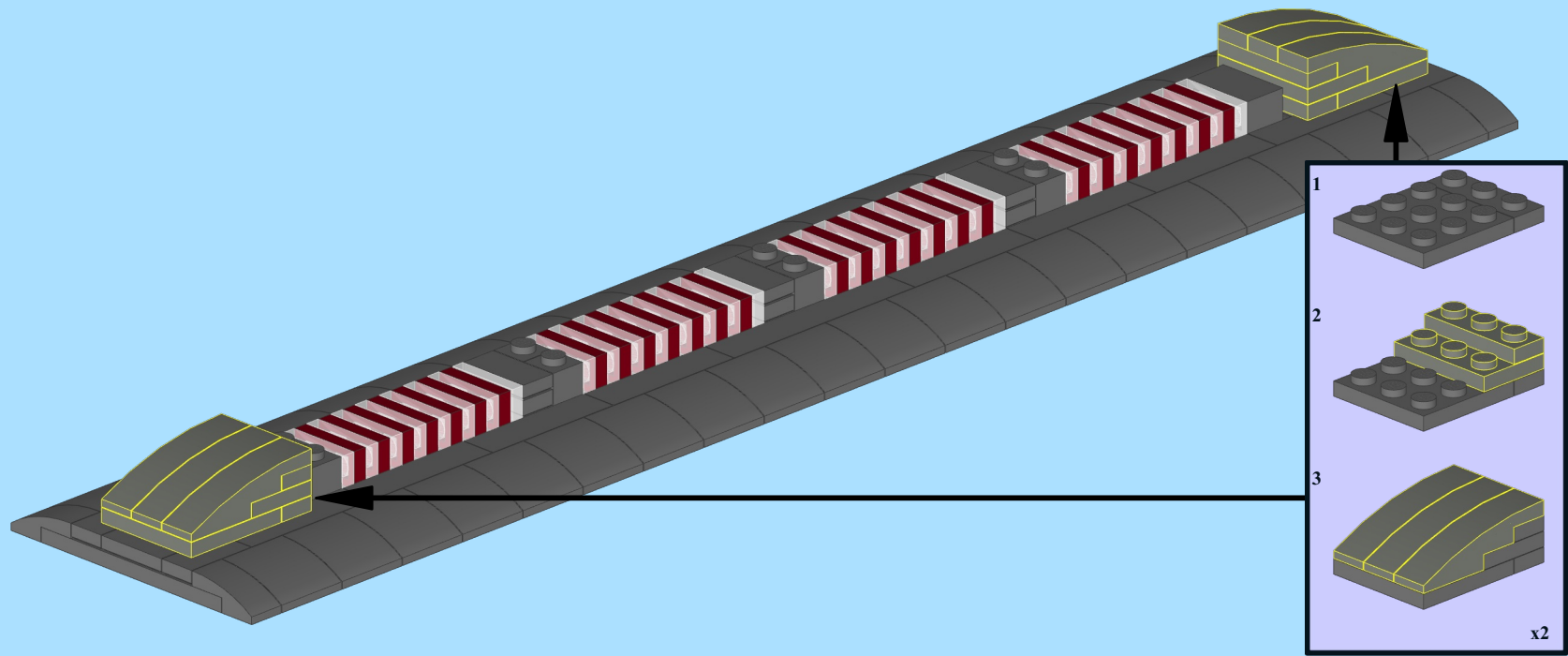
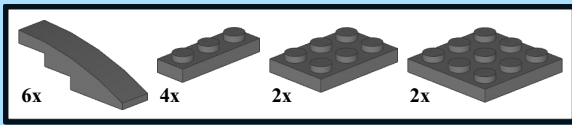

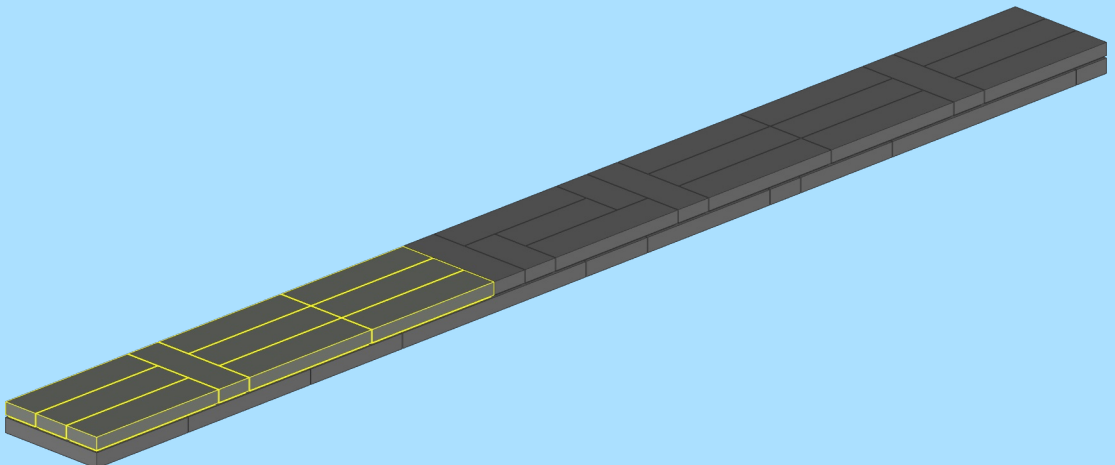
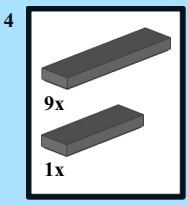
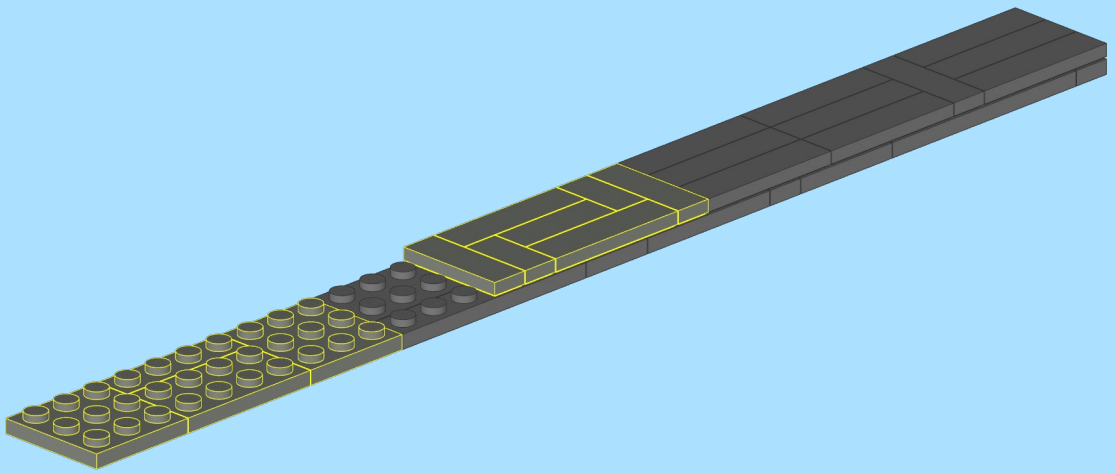
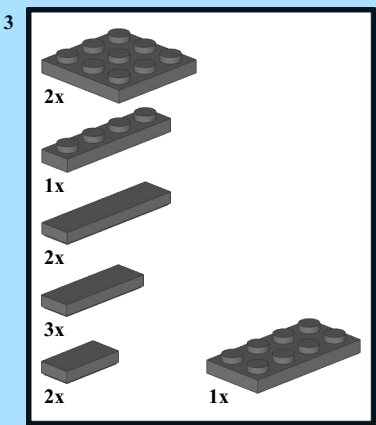
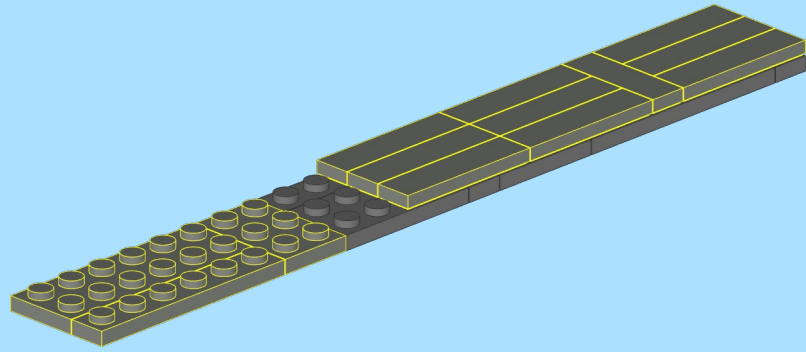
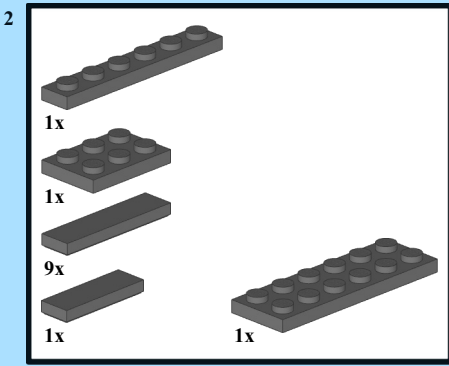
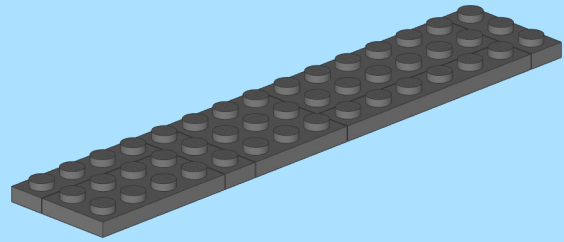
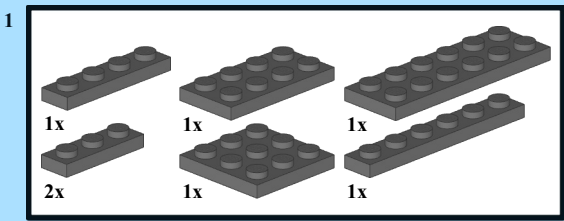

13

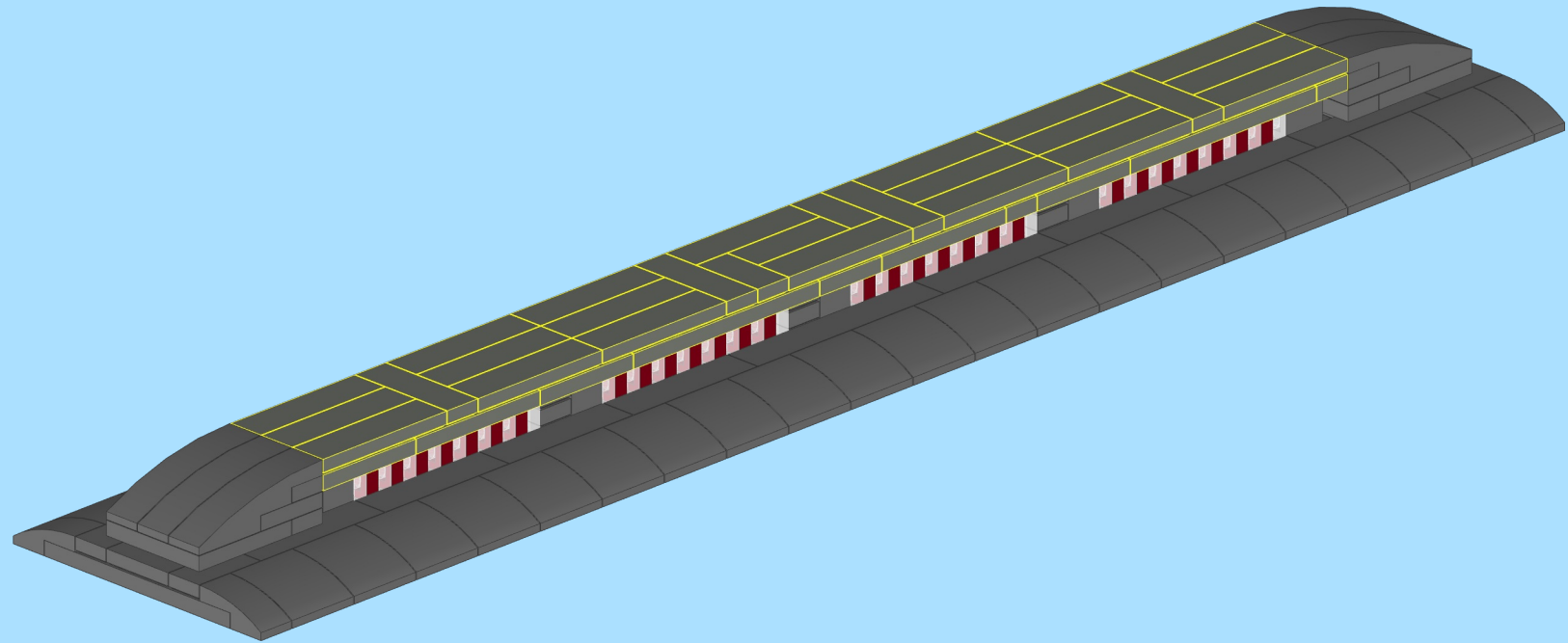

14

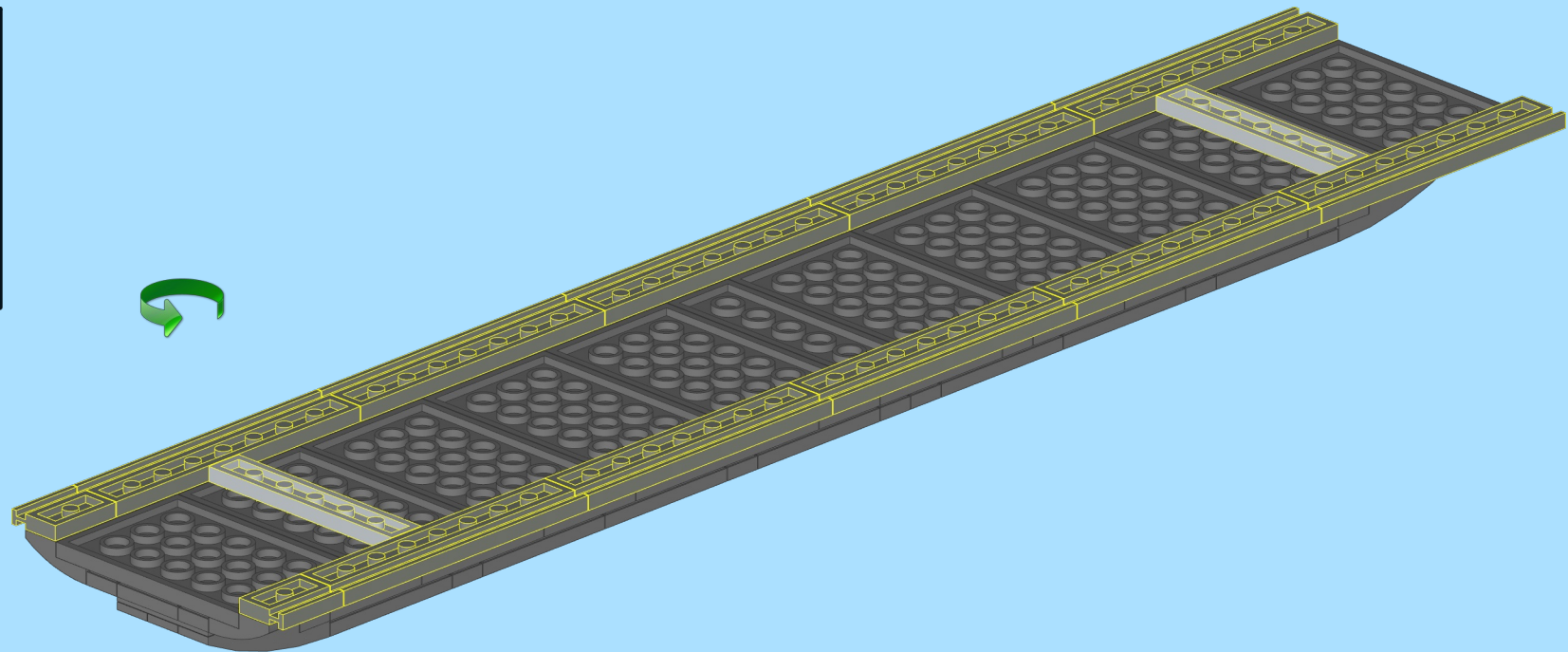
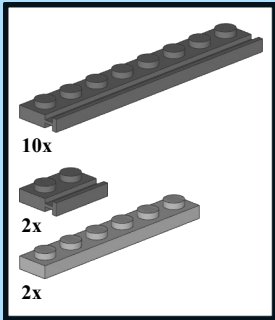

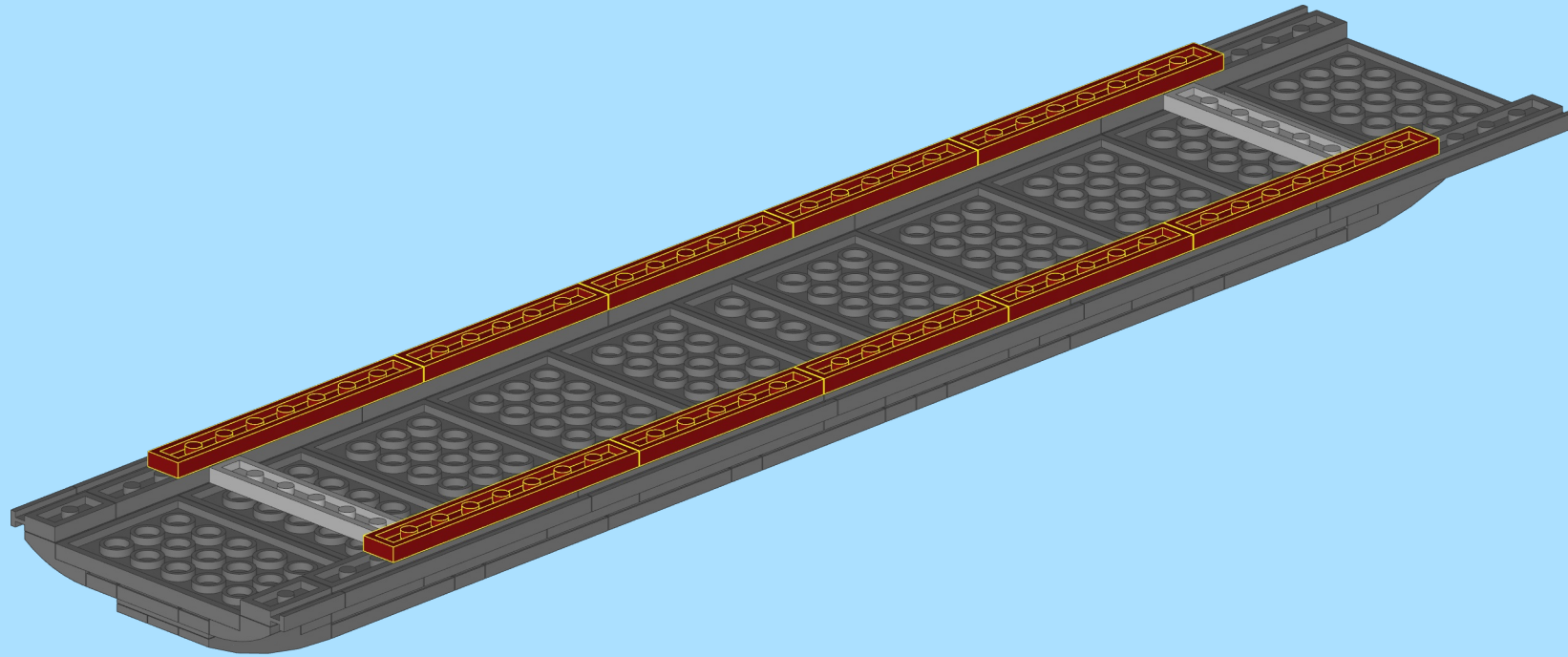
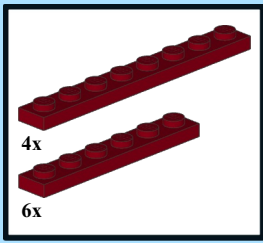

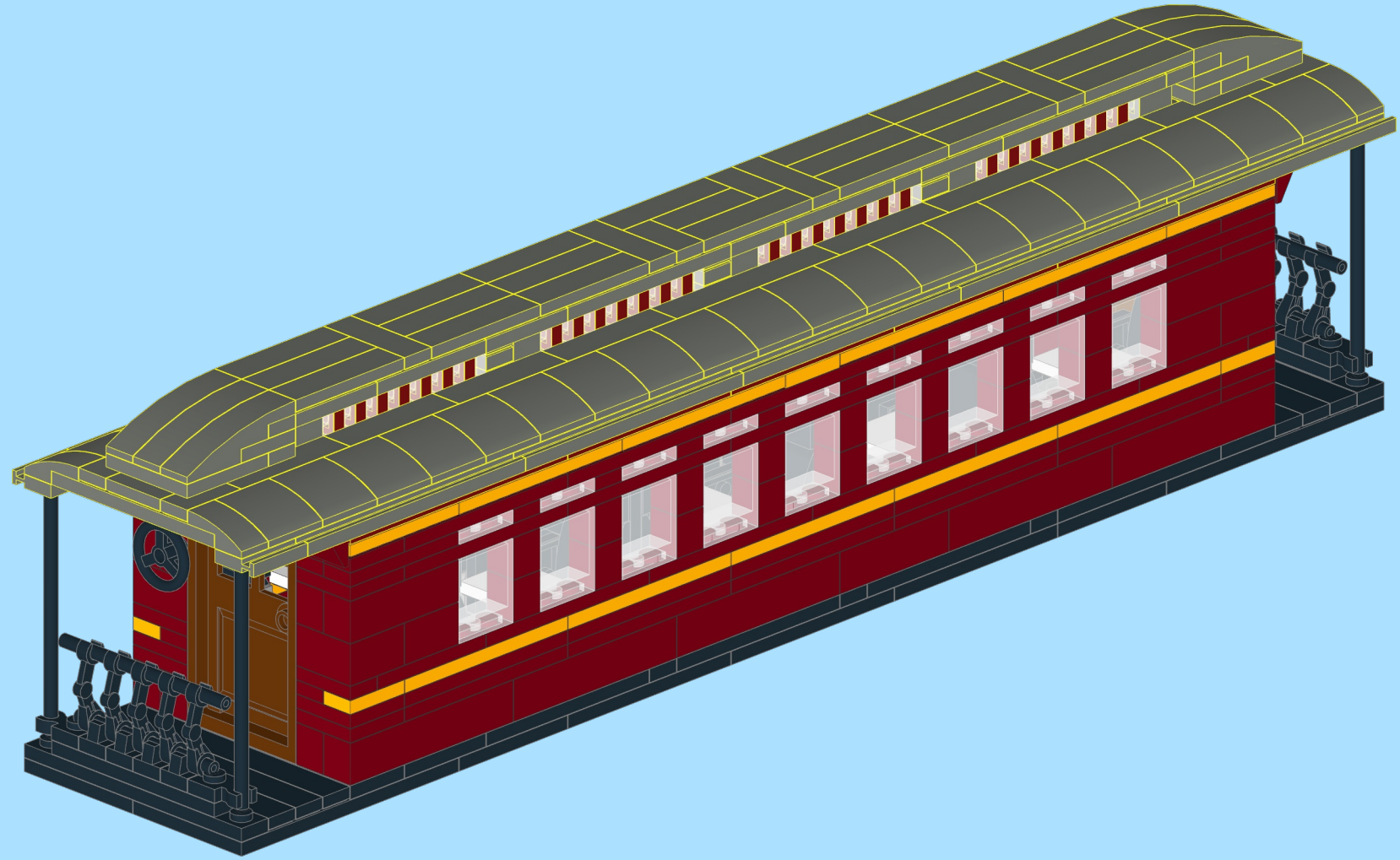

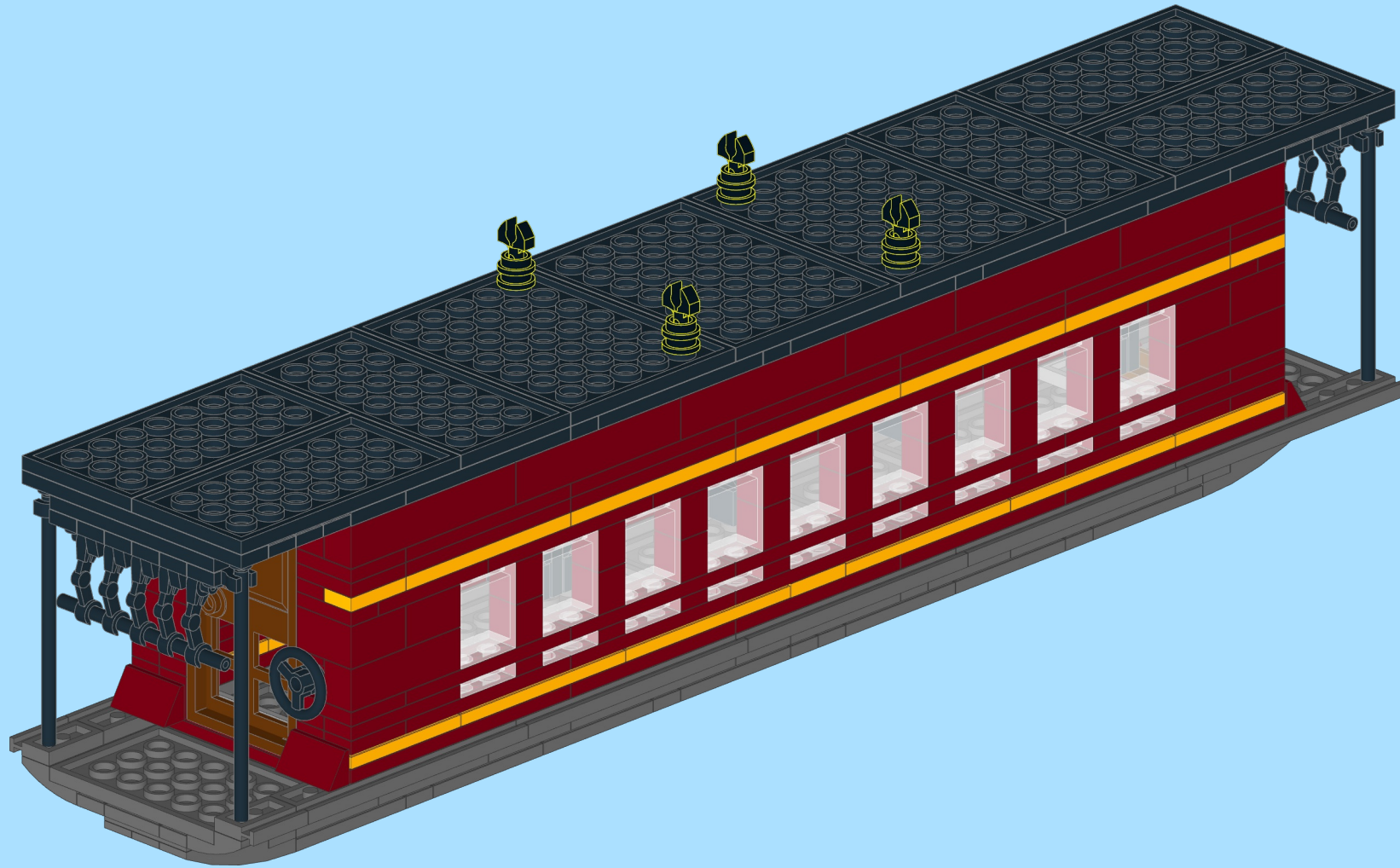

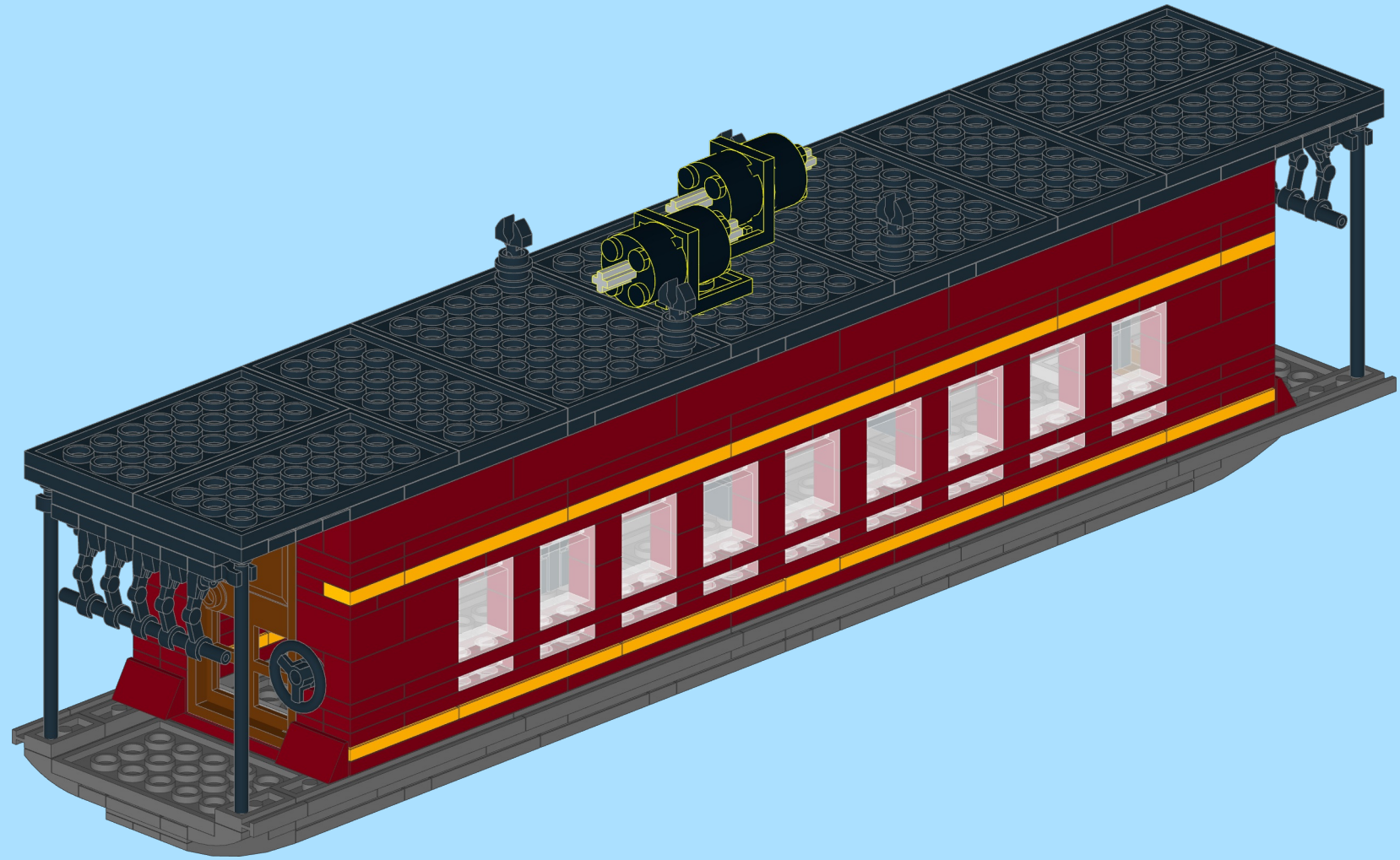
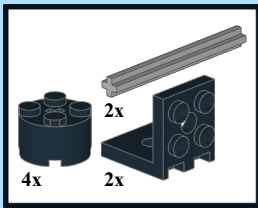

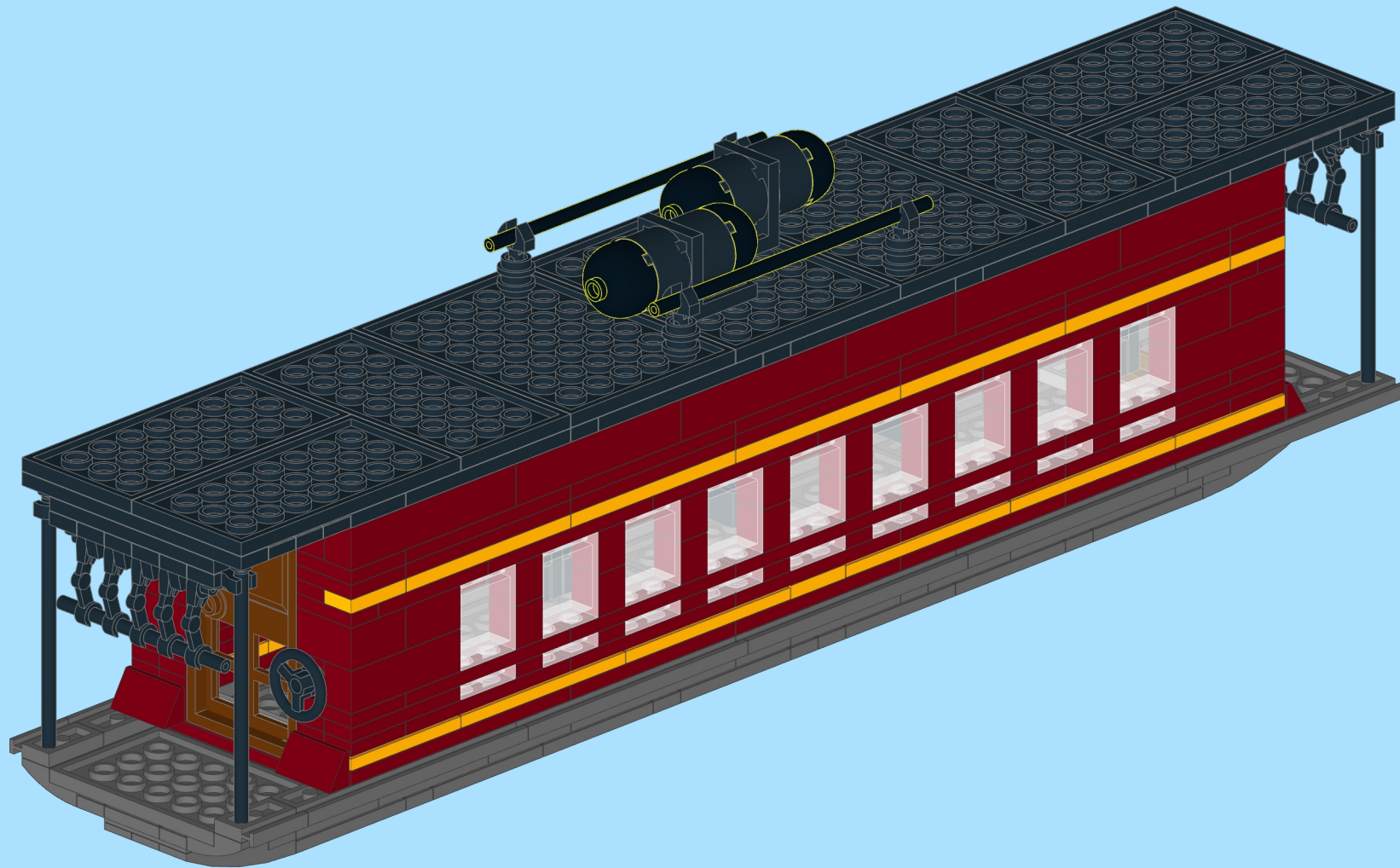

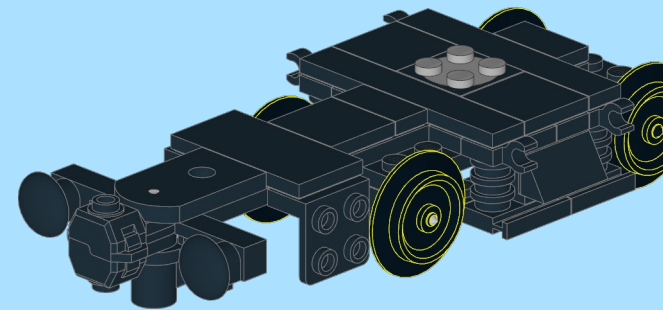
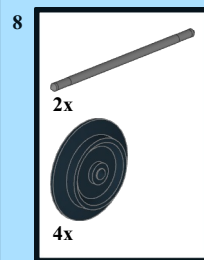
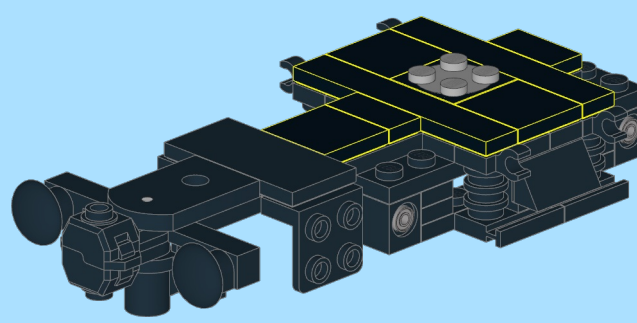
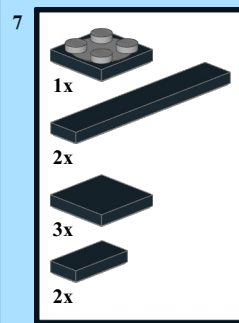
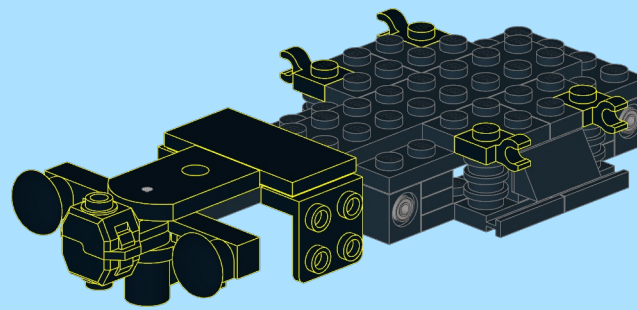
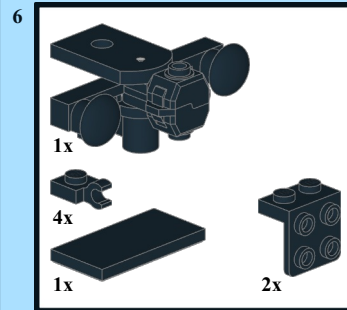
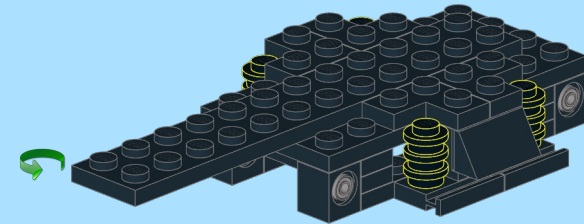
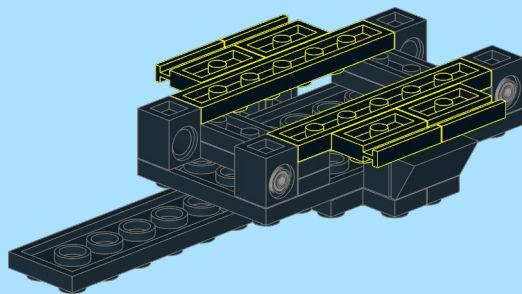
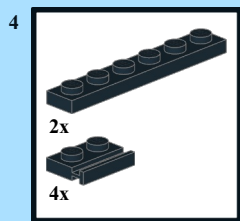
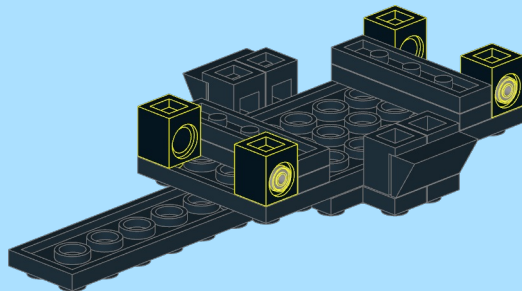
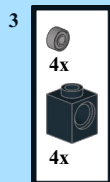
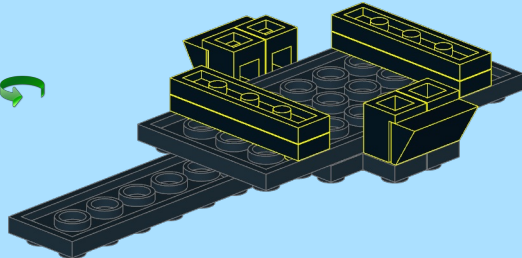
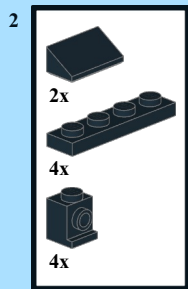
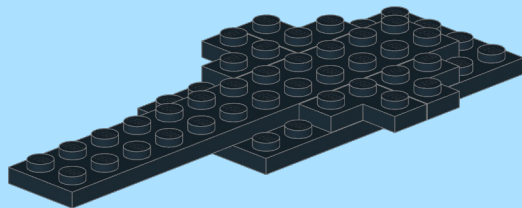
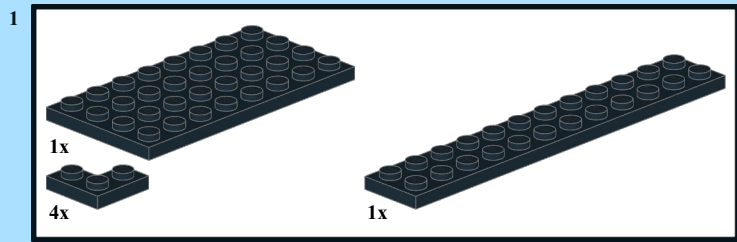

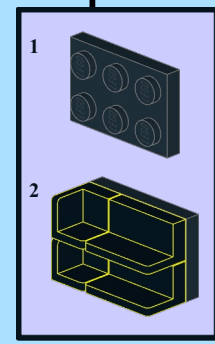
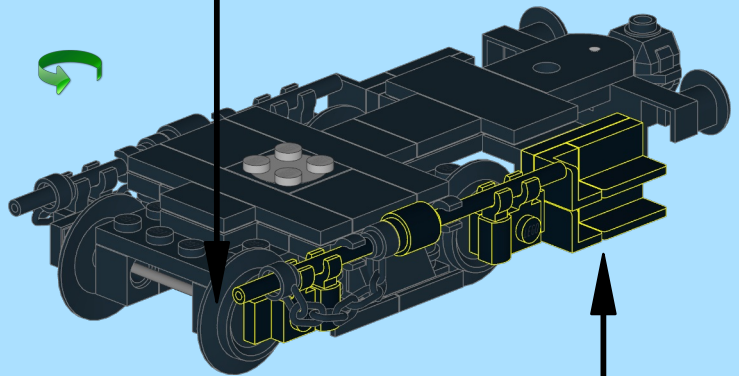
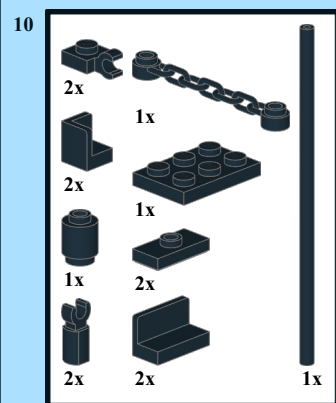
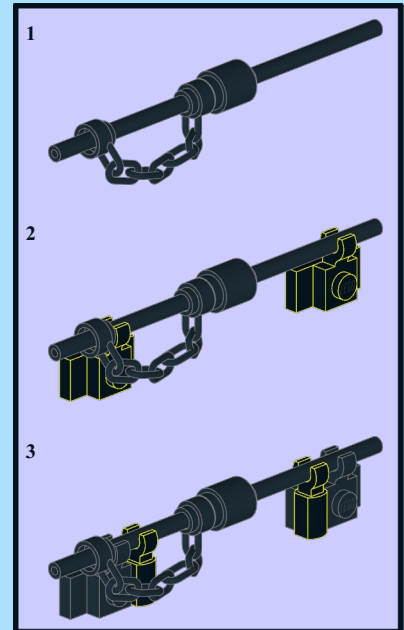
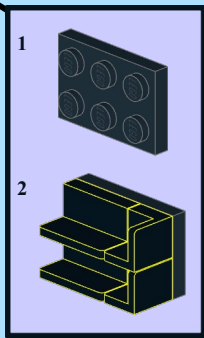
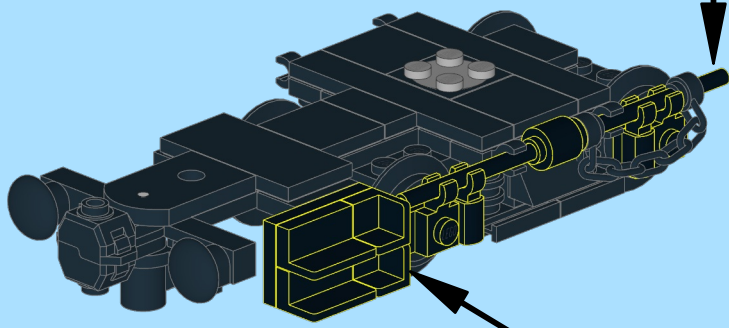
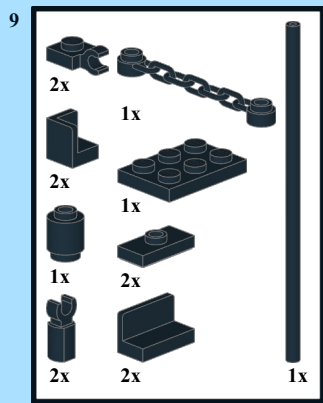
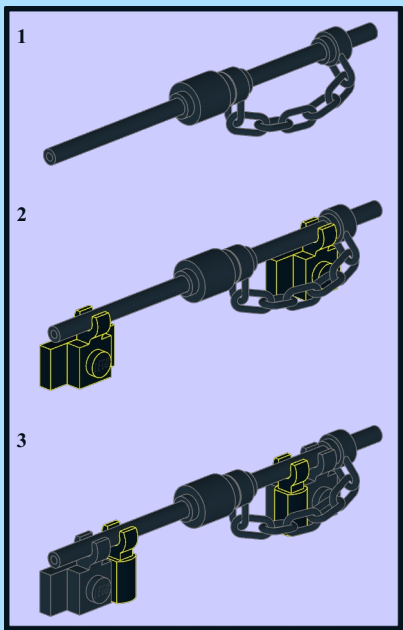

x2

