

# Pacific Observation Car

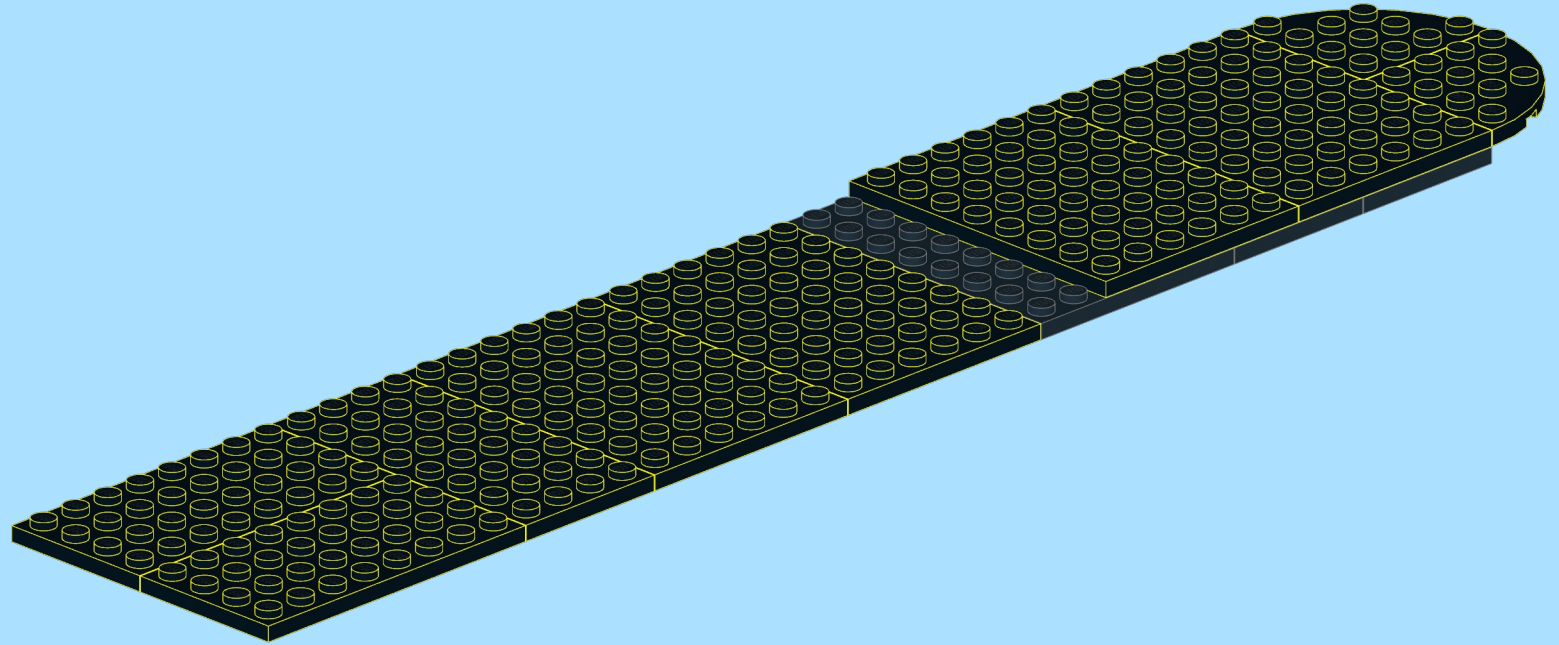

DESIGNED BY  
**KNUD ALBRECHTSEN**  
[www.snakebyte.dk/lego](http://www.snakebyte.dk/lego)

INSTRUCTION BY  
**KNUD ALBRECHTSEN**  
[www.snakebyte.dk/lego](http://www.snakebyte.dk/lego)

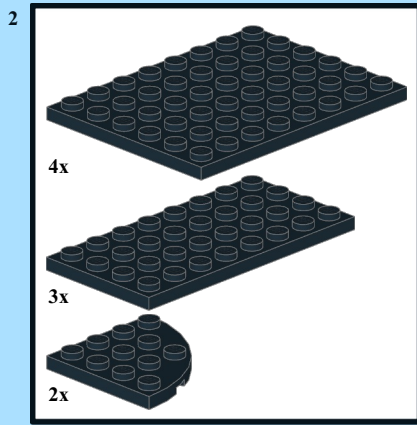
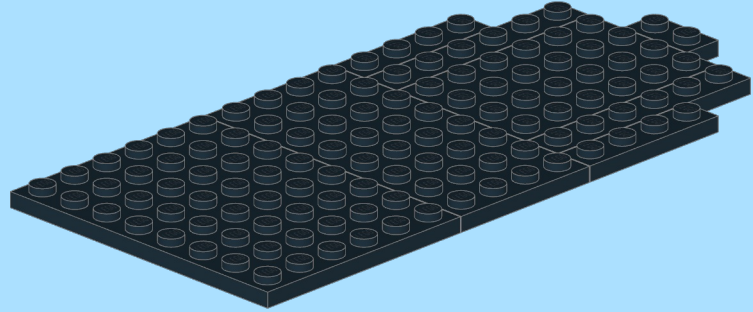
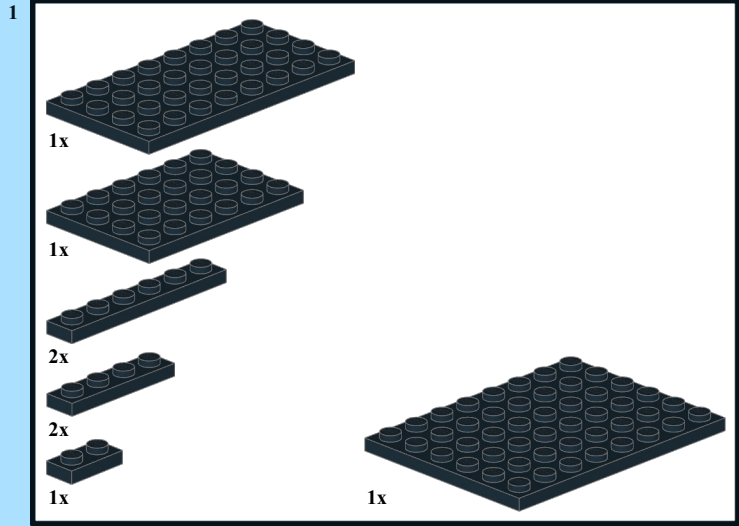

3

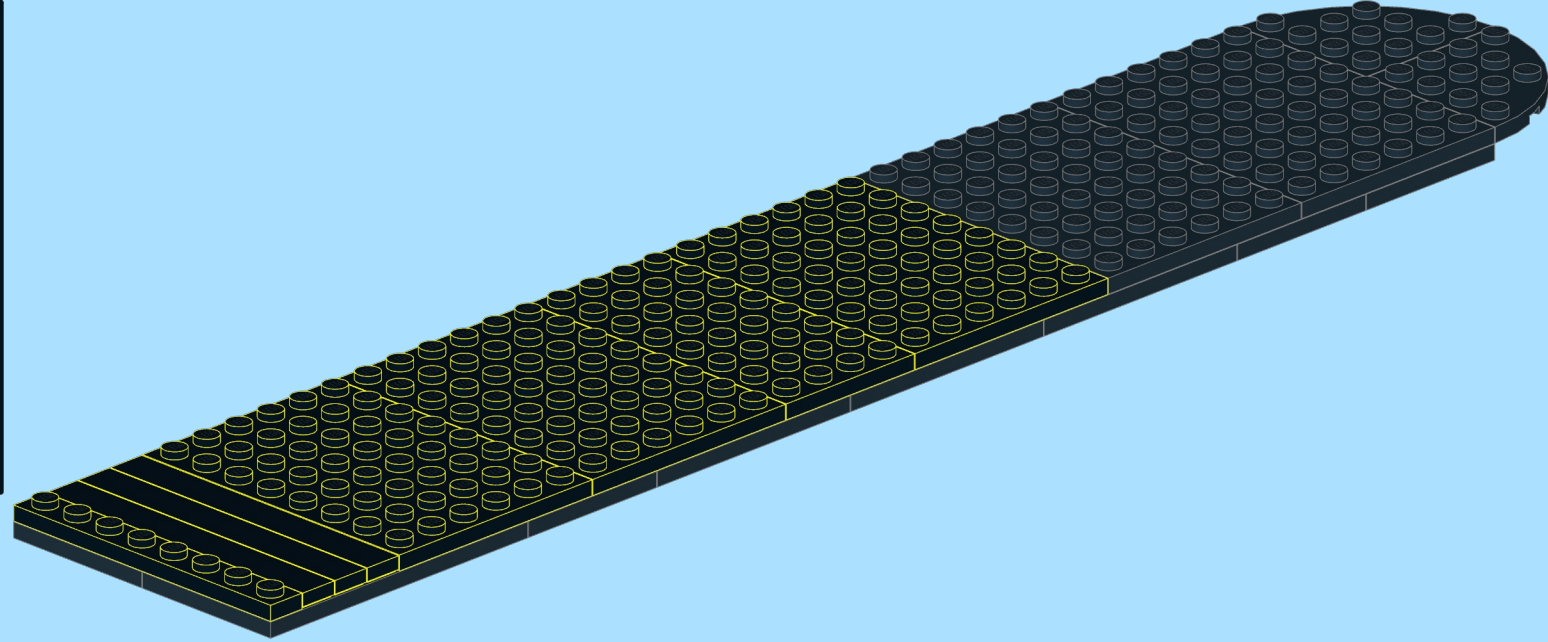
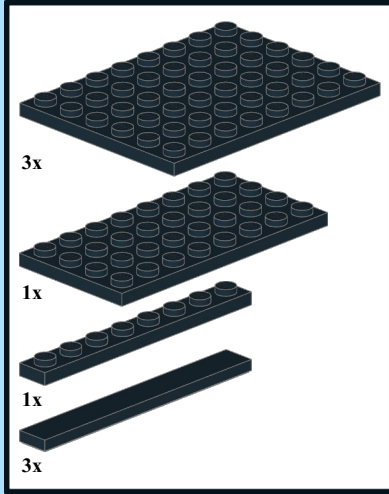

4

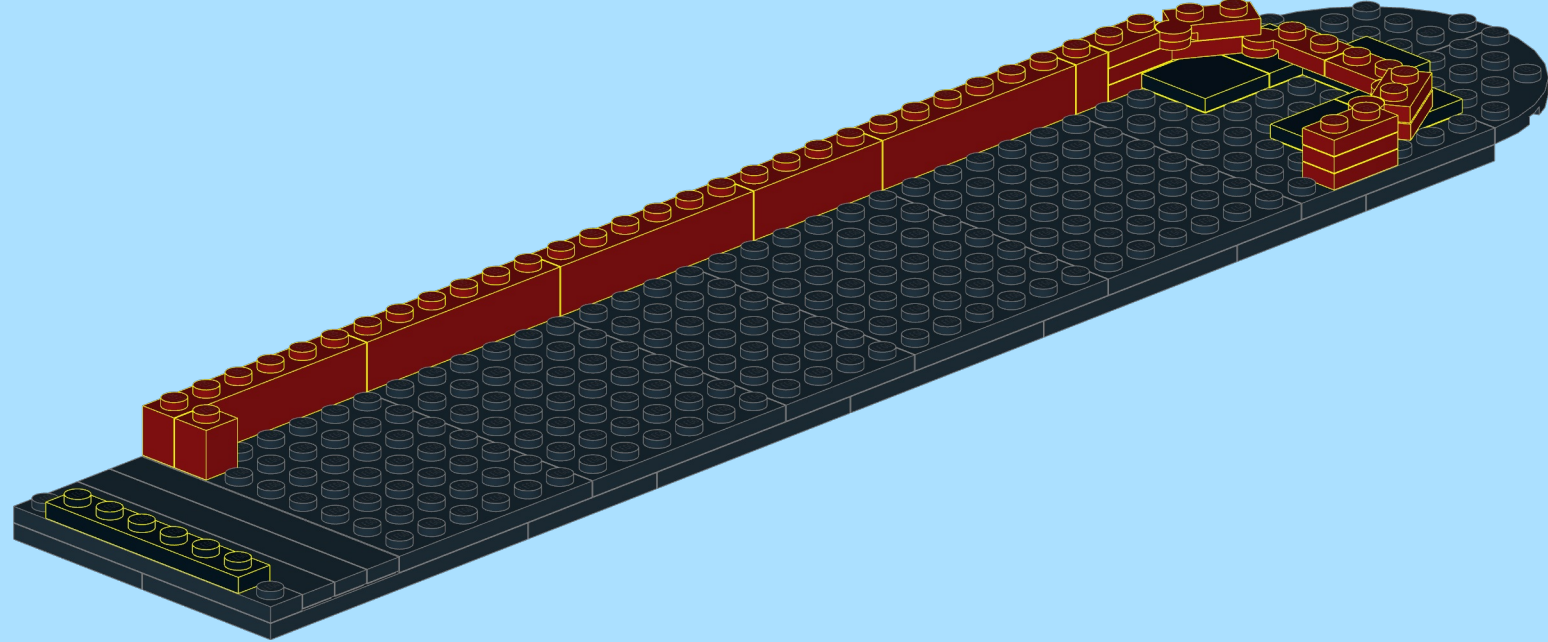
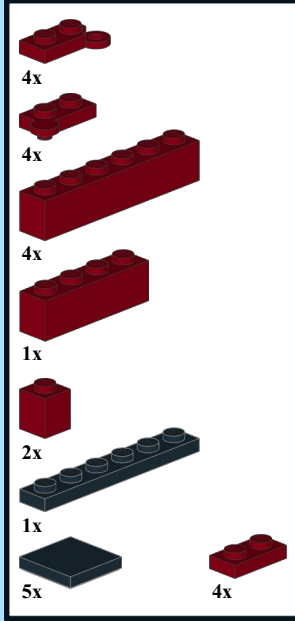

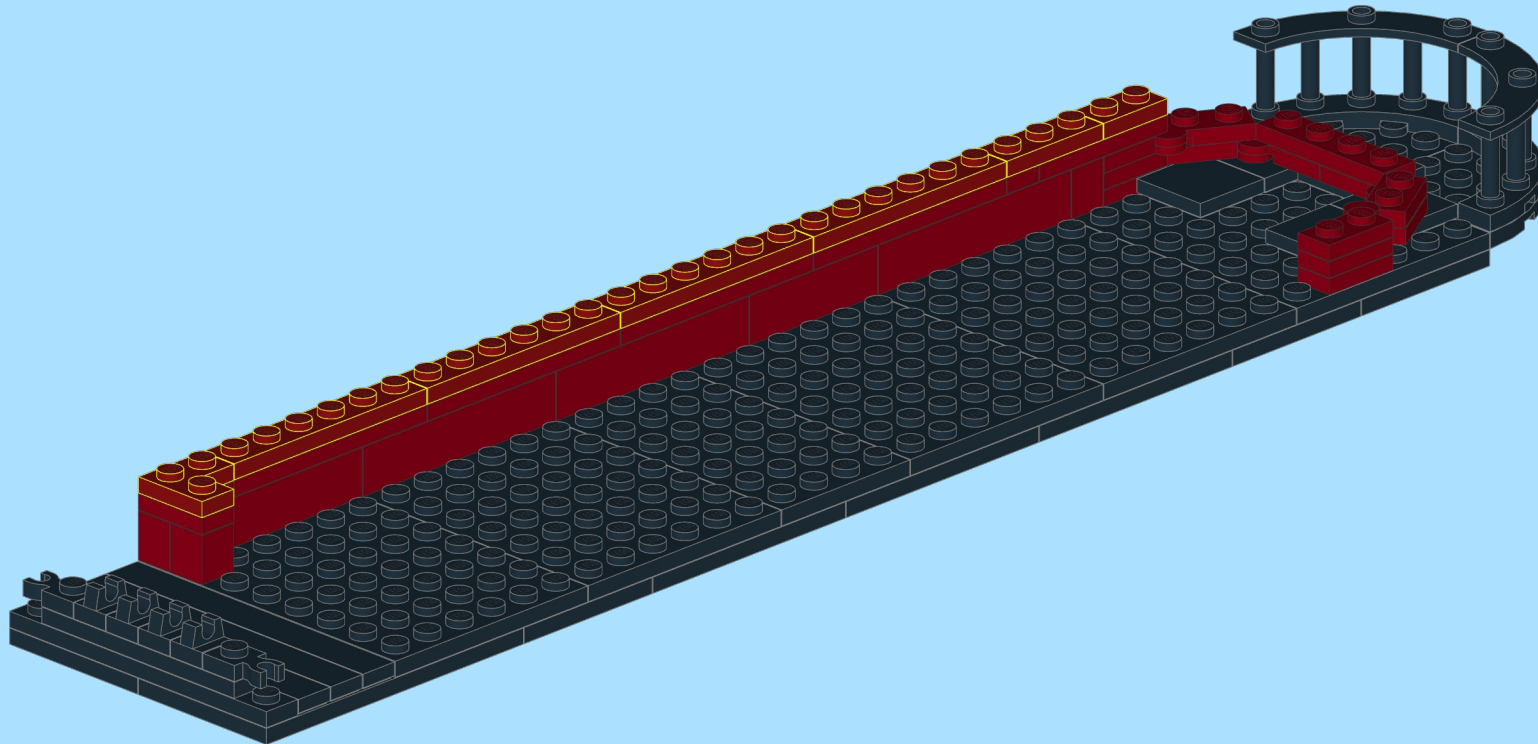
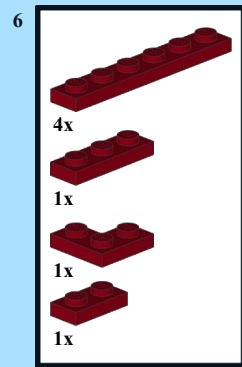
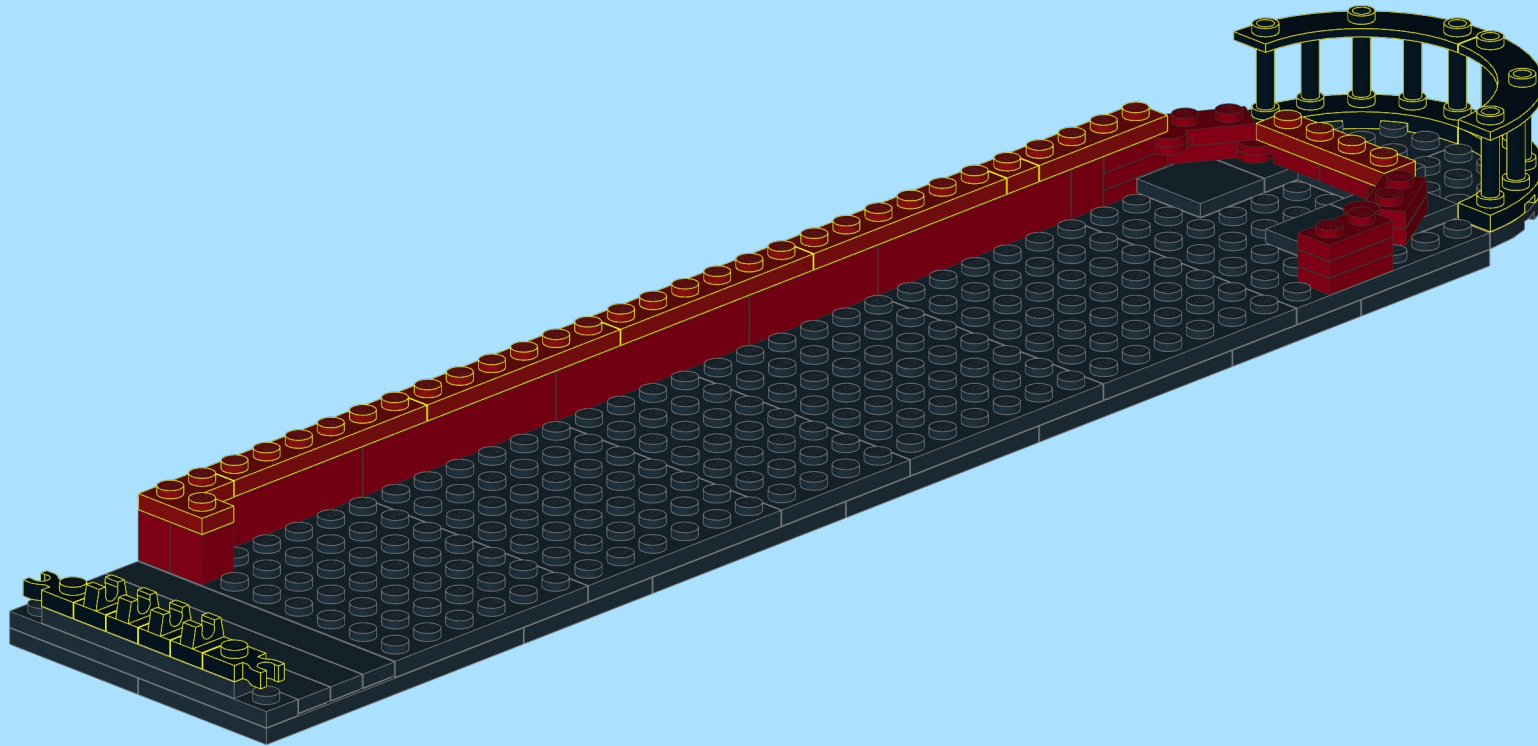
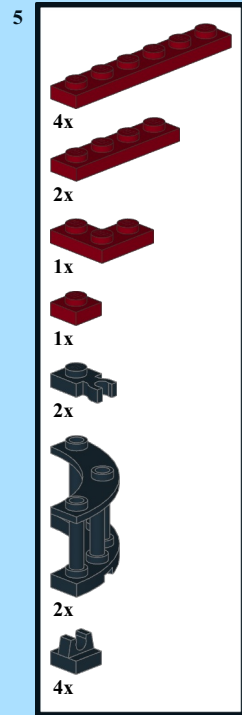

7

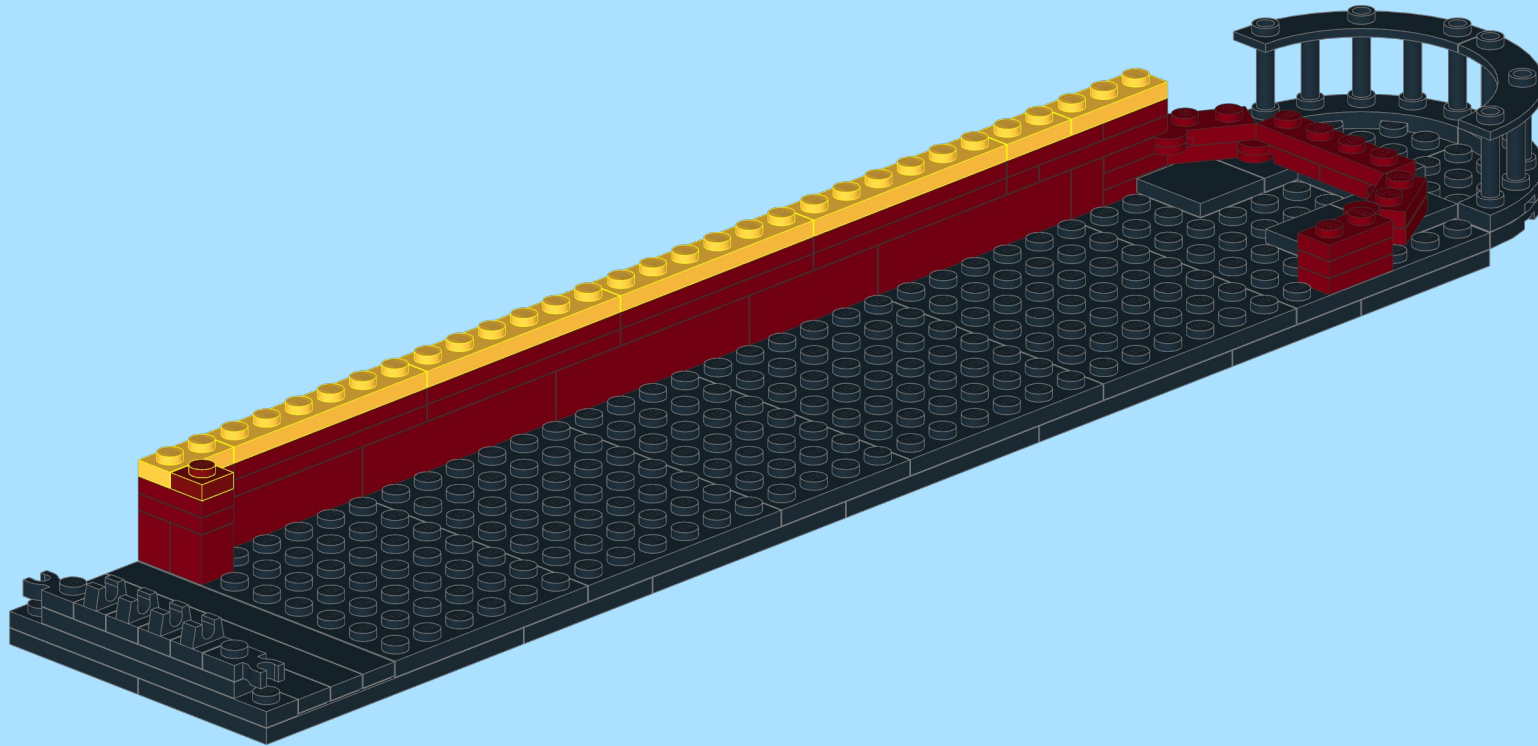
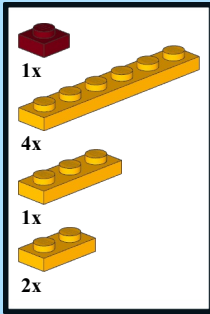

8

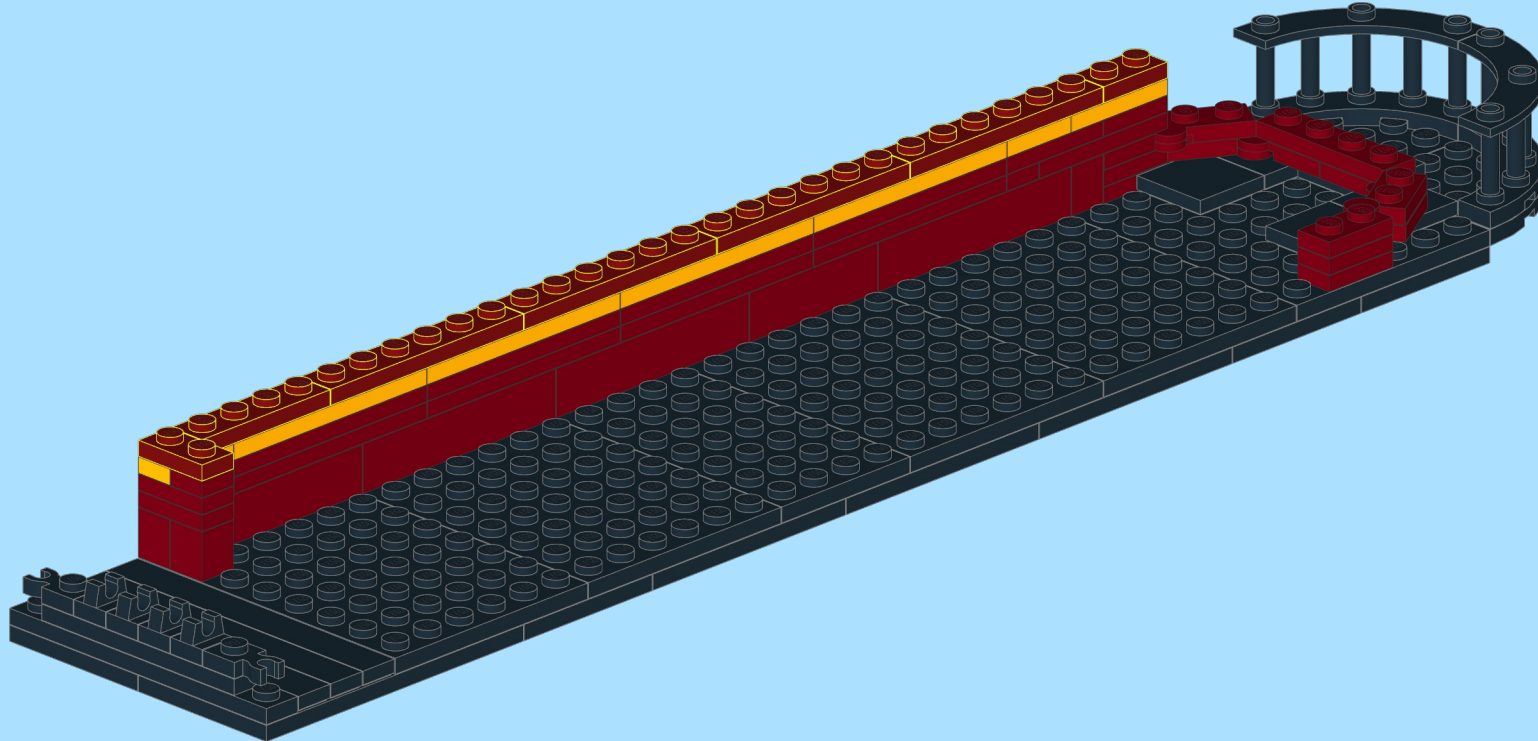
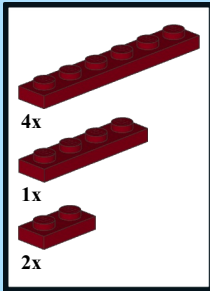

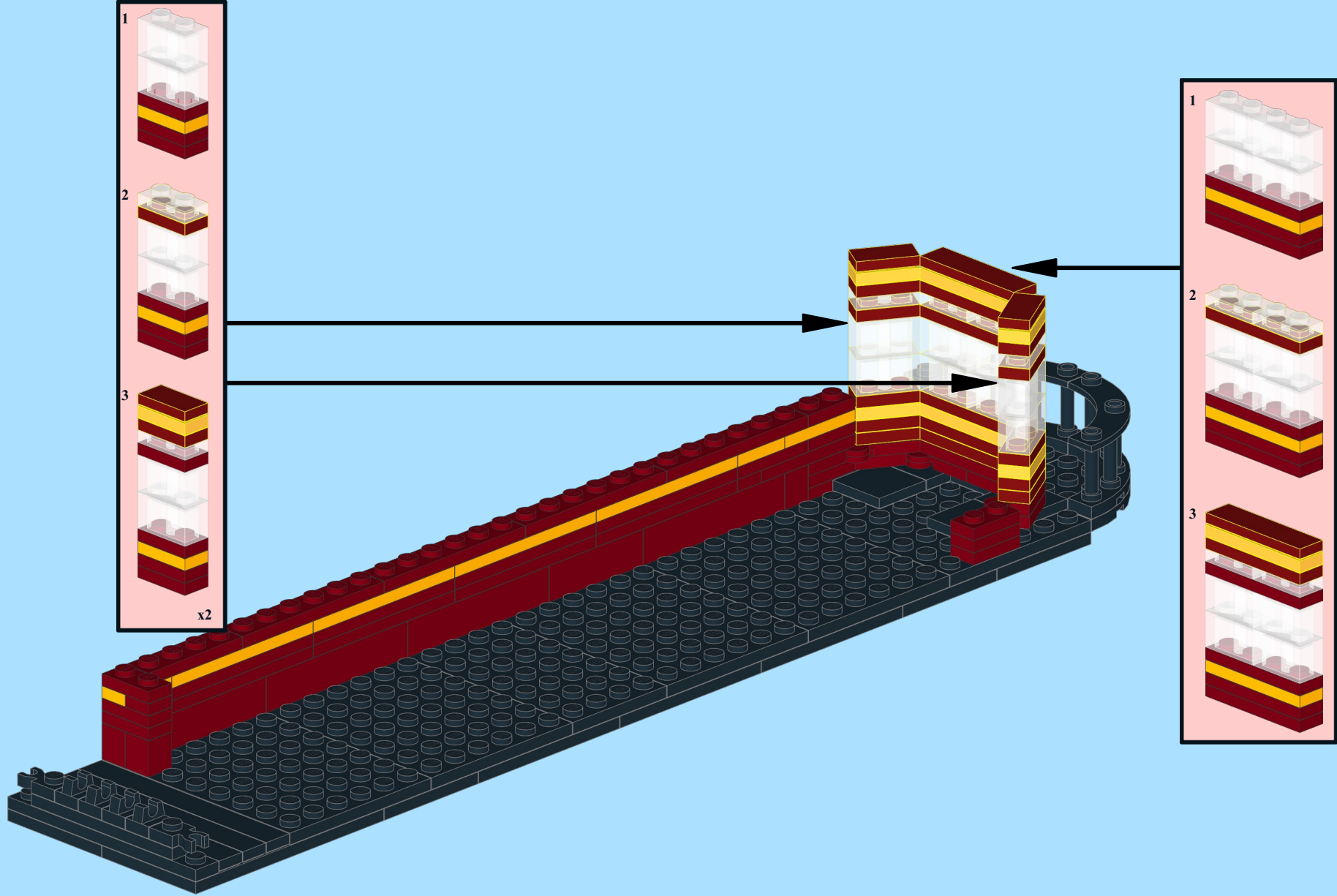
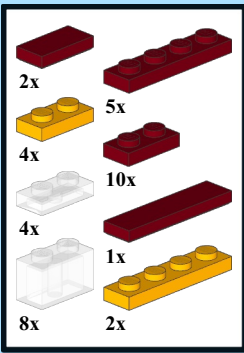

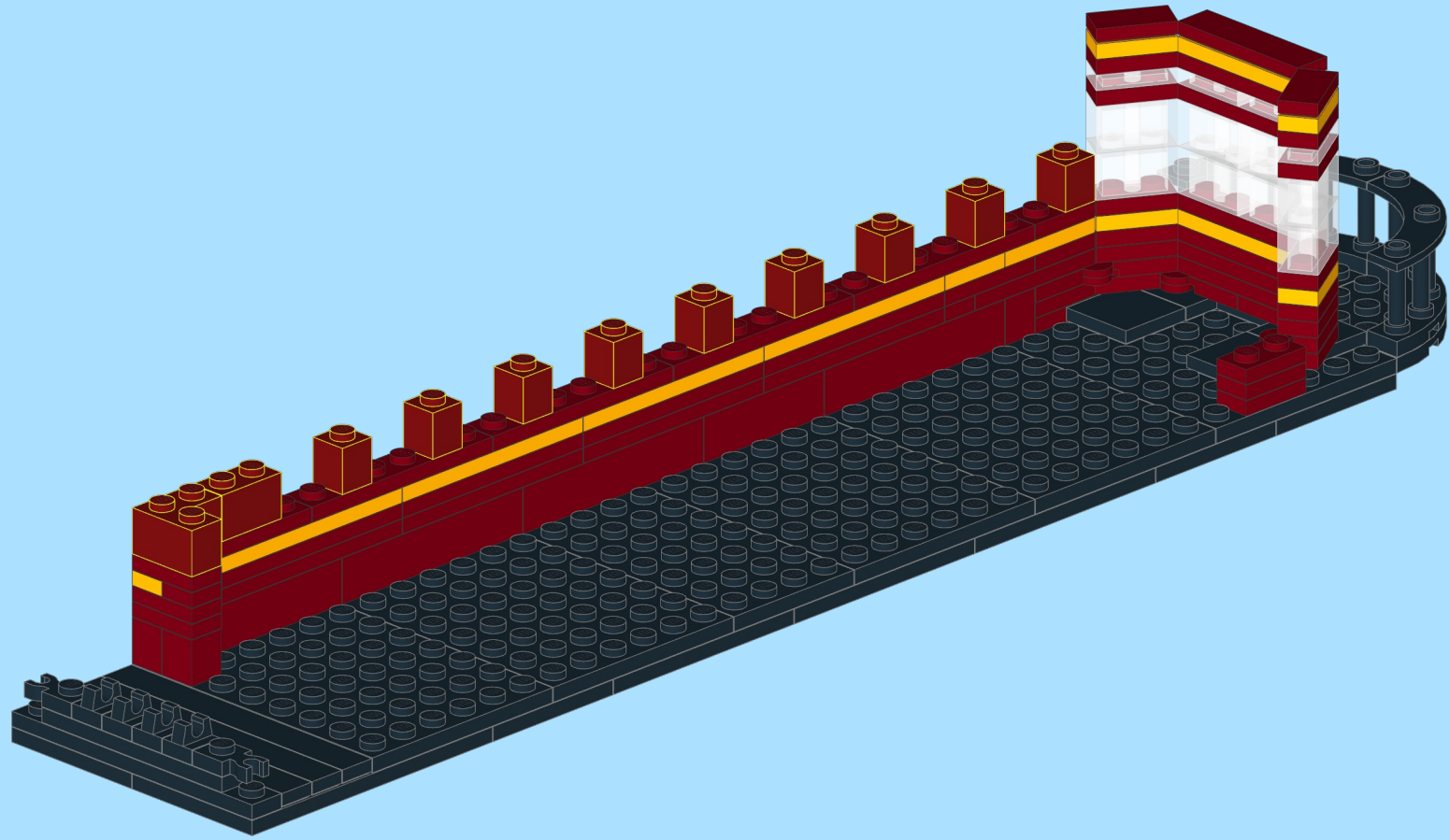
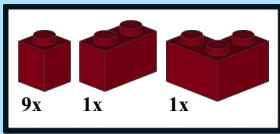

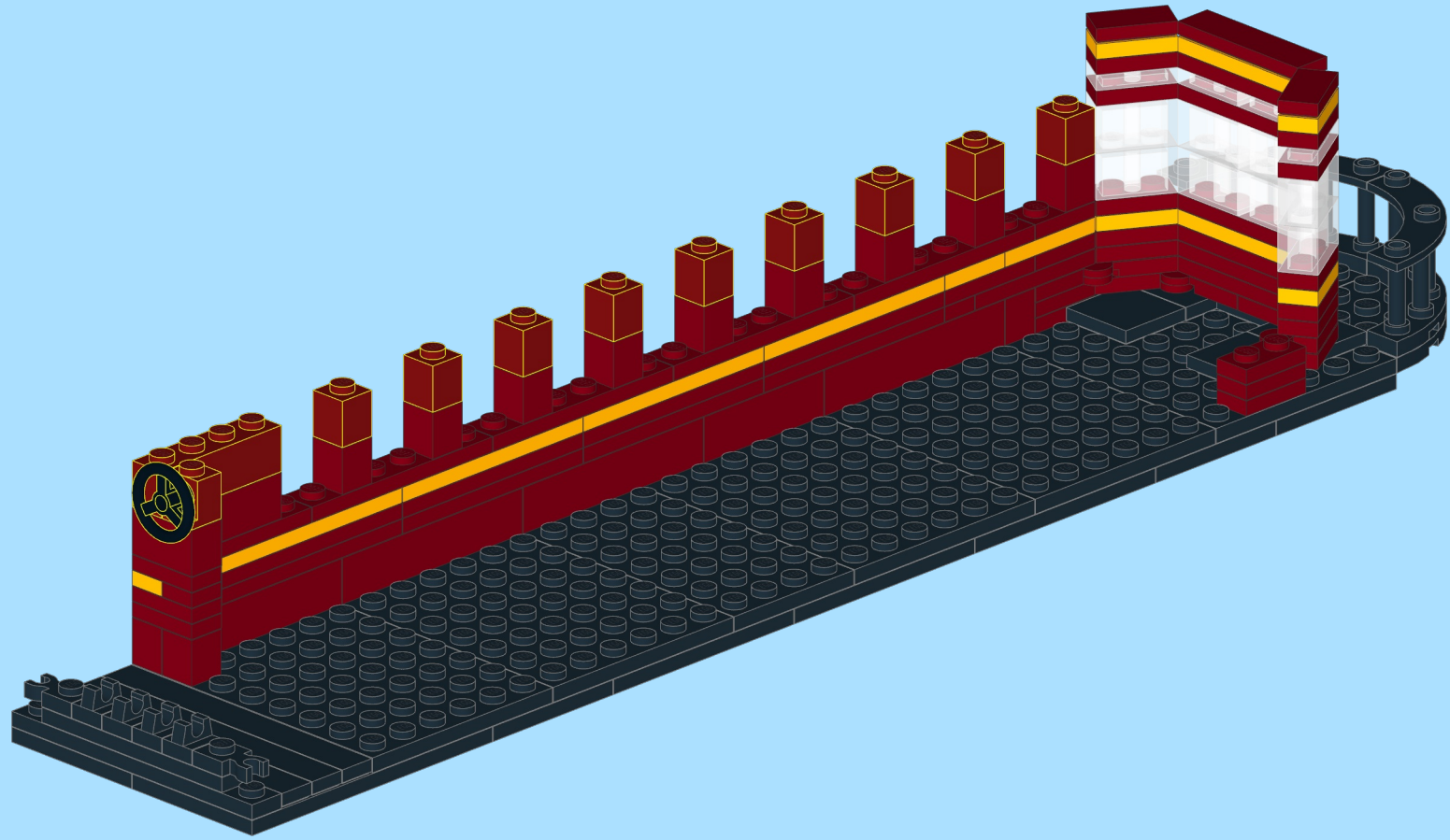
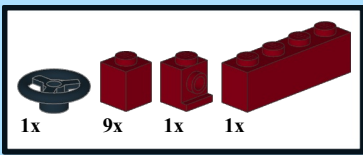



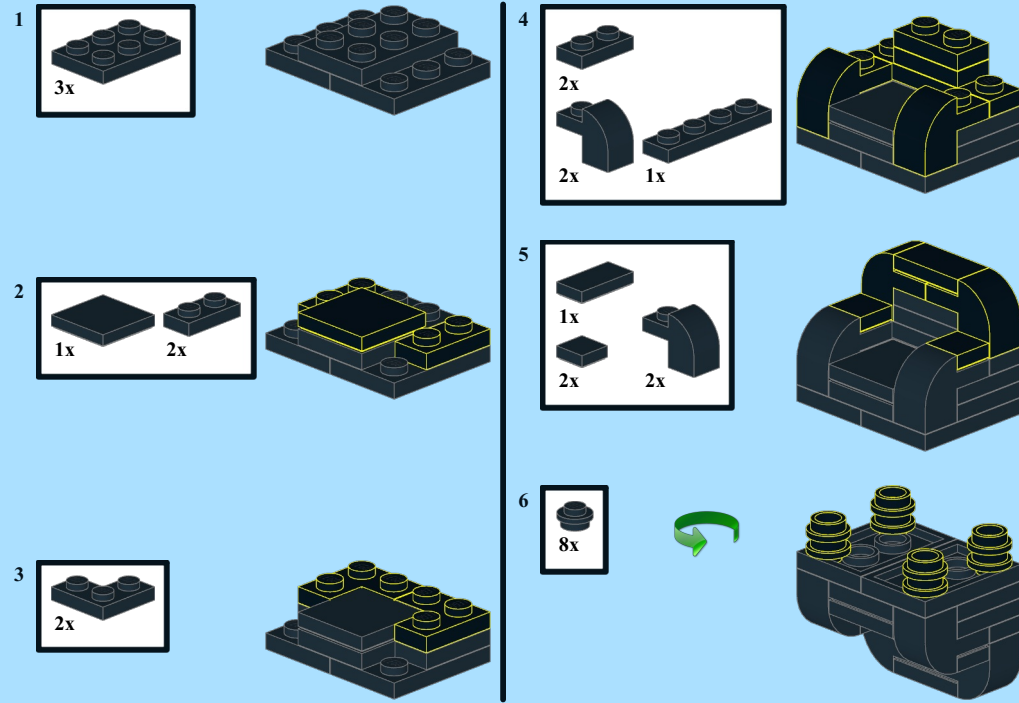

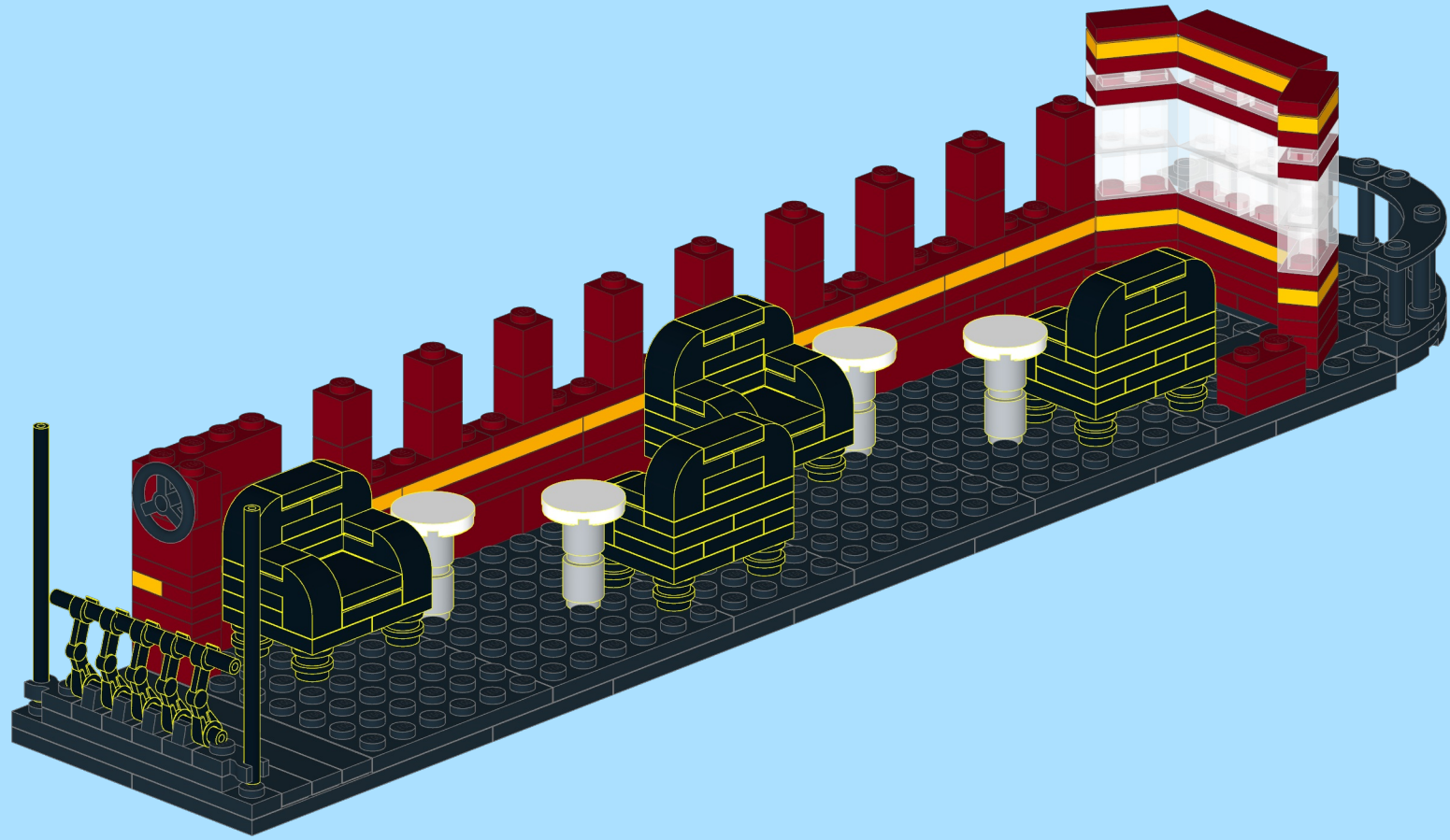
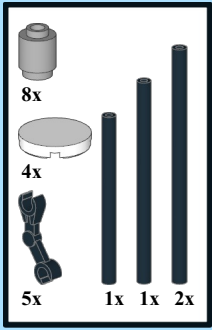

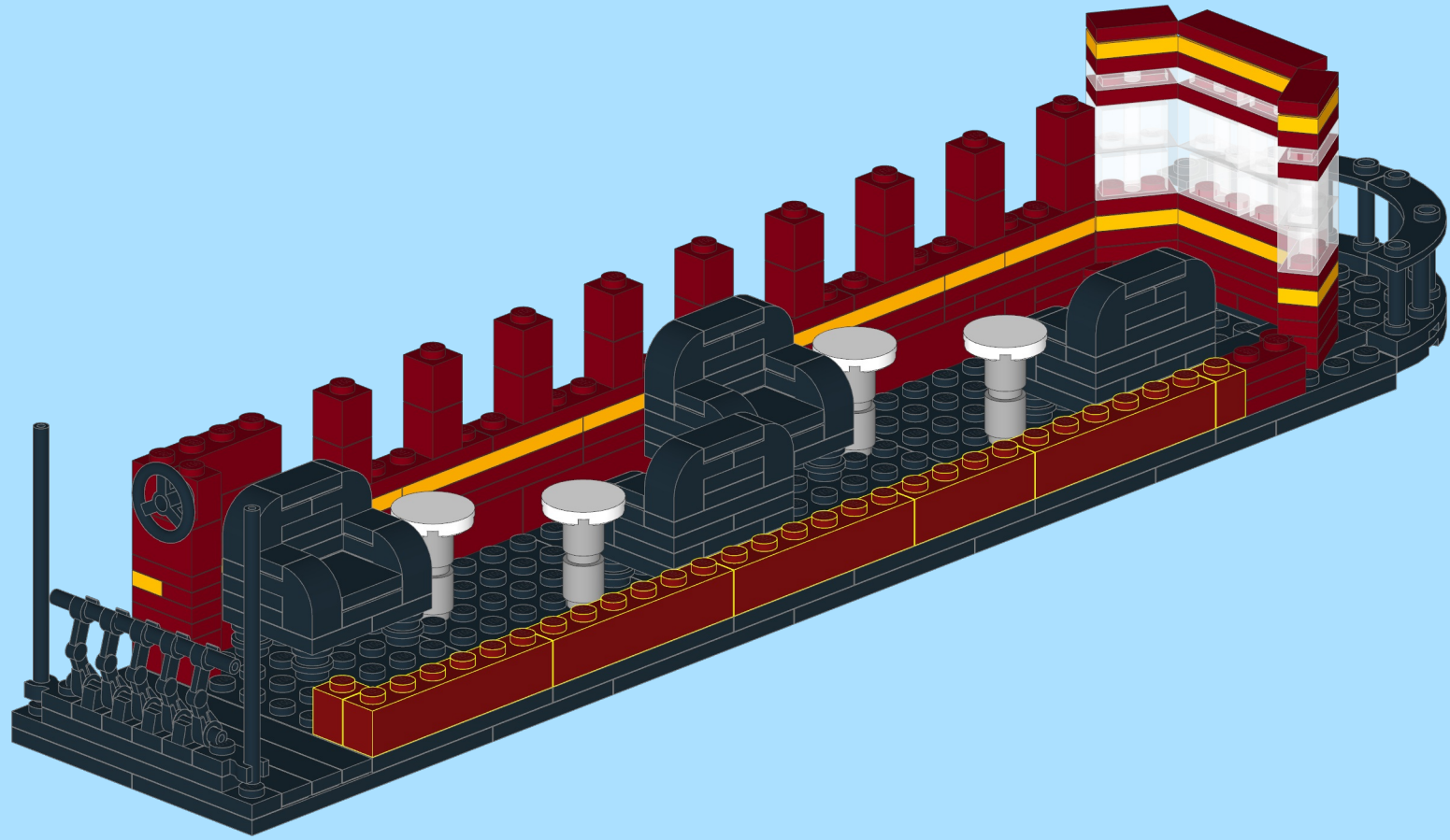
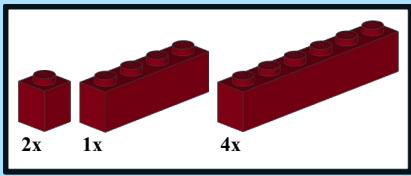

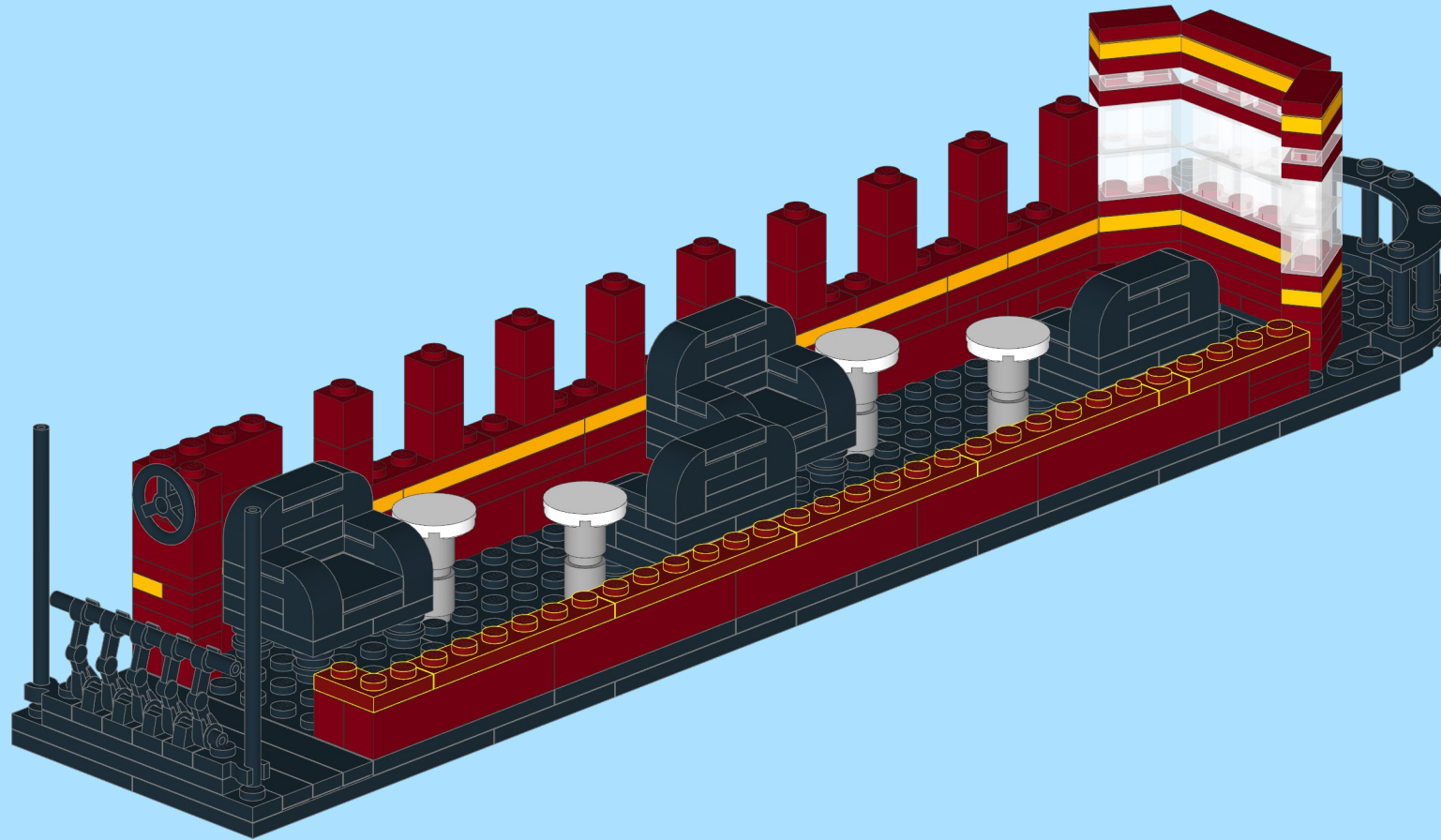
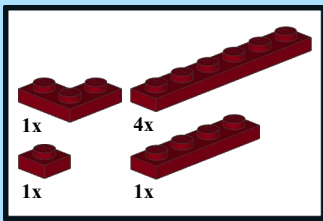

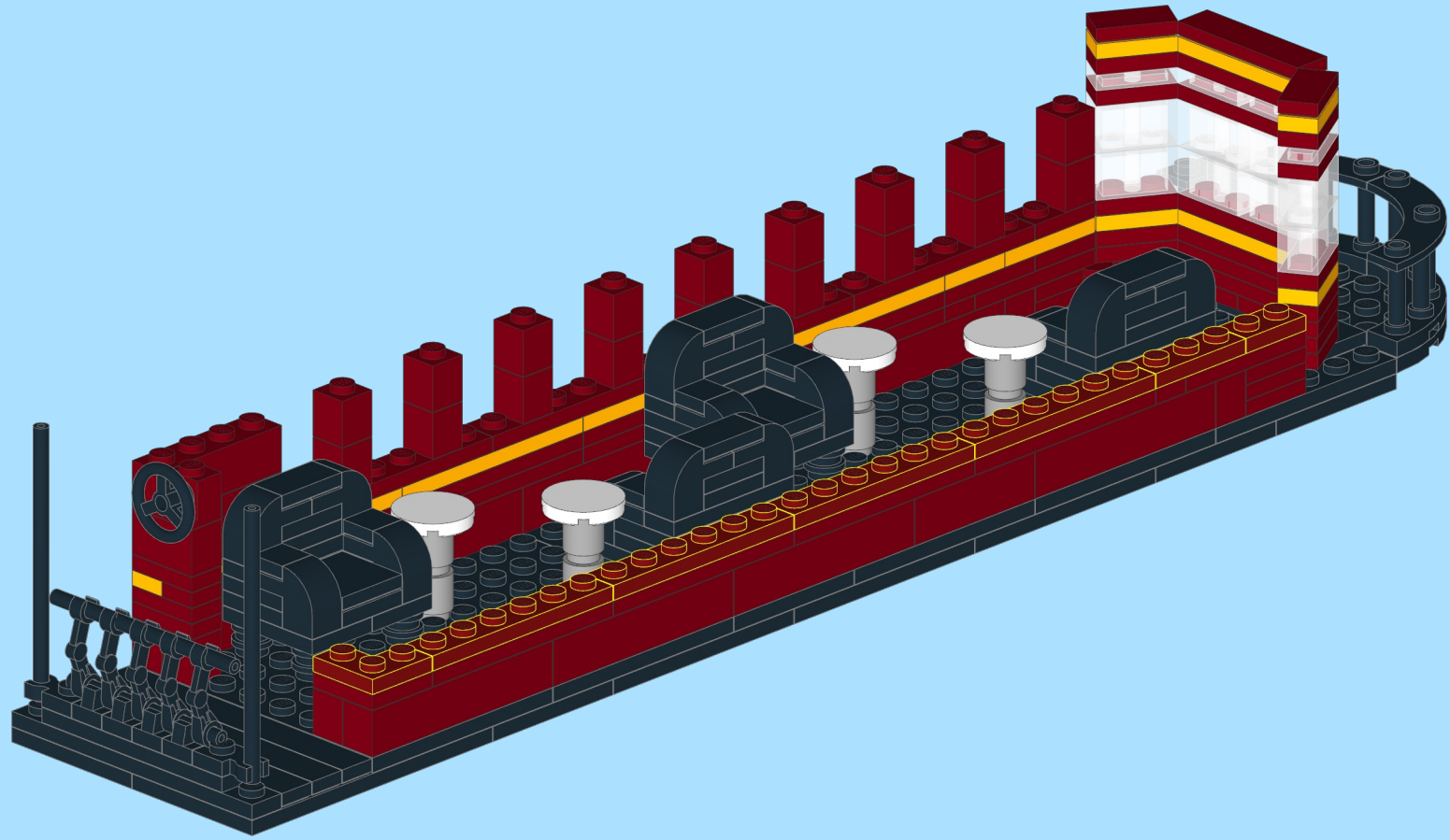
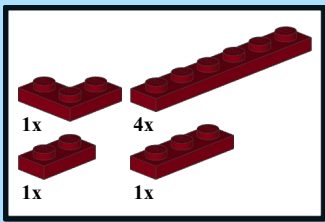

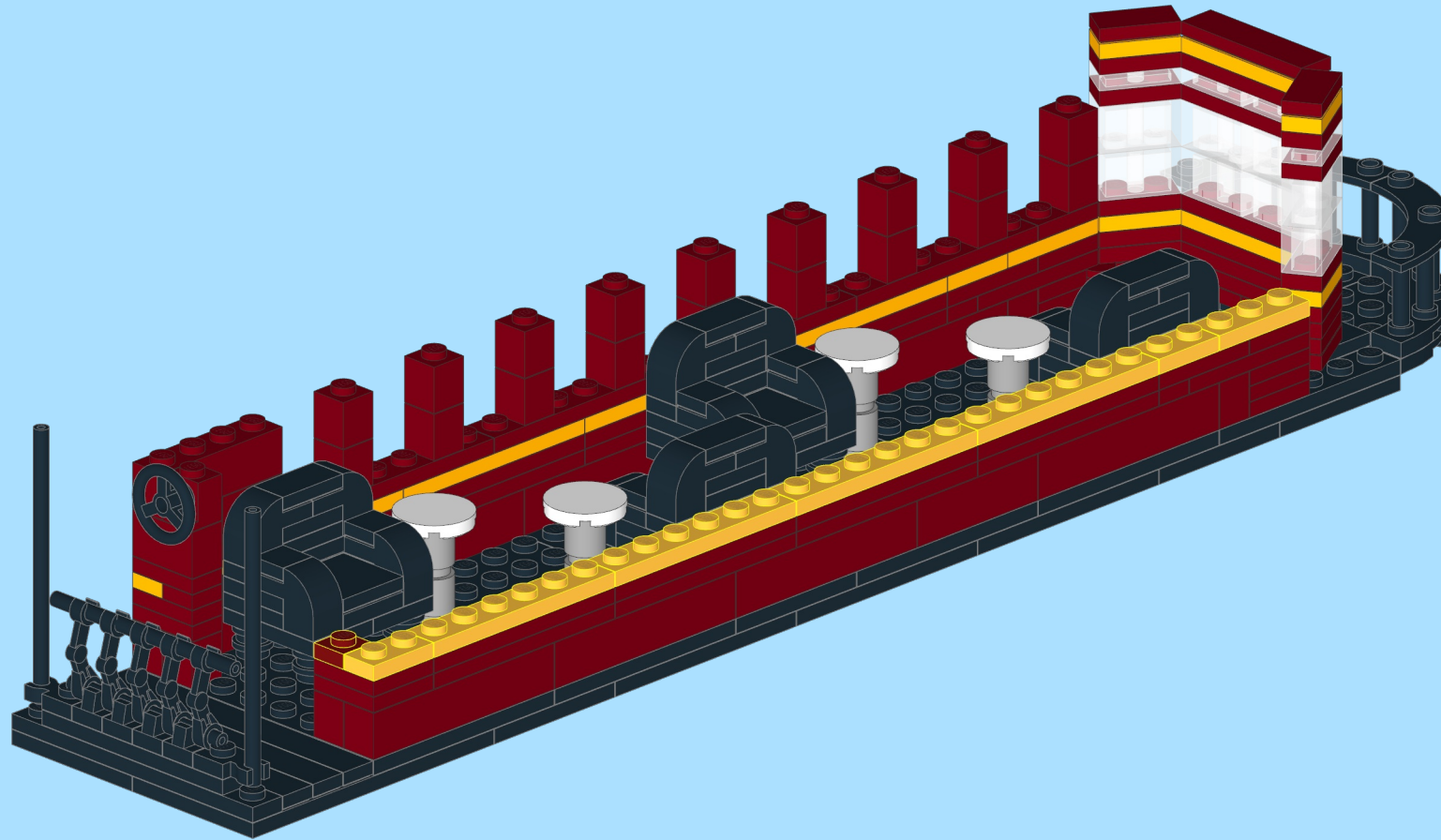
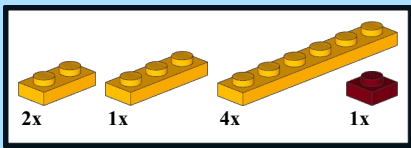

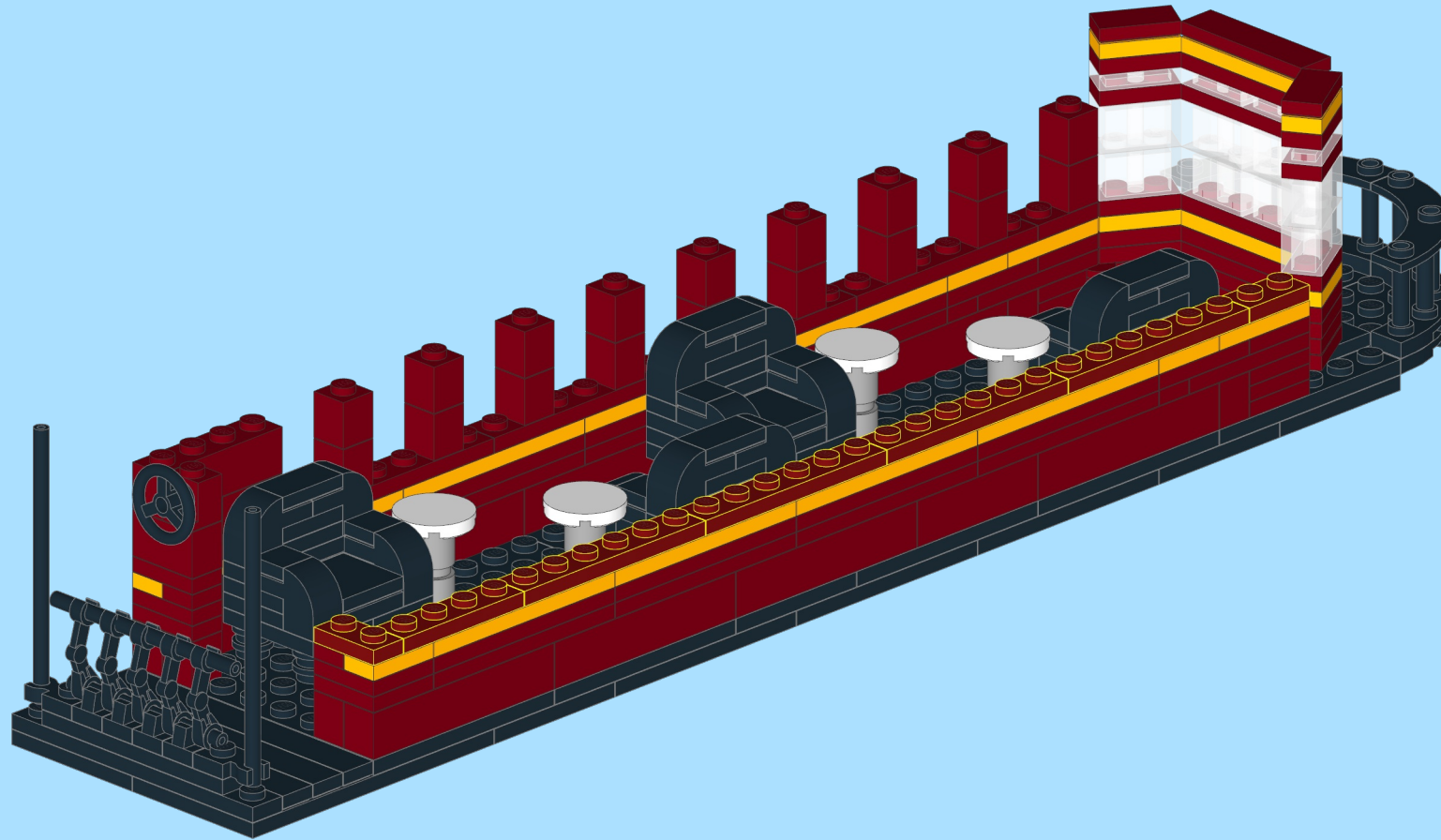
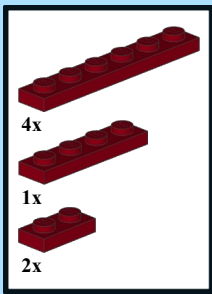

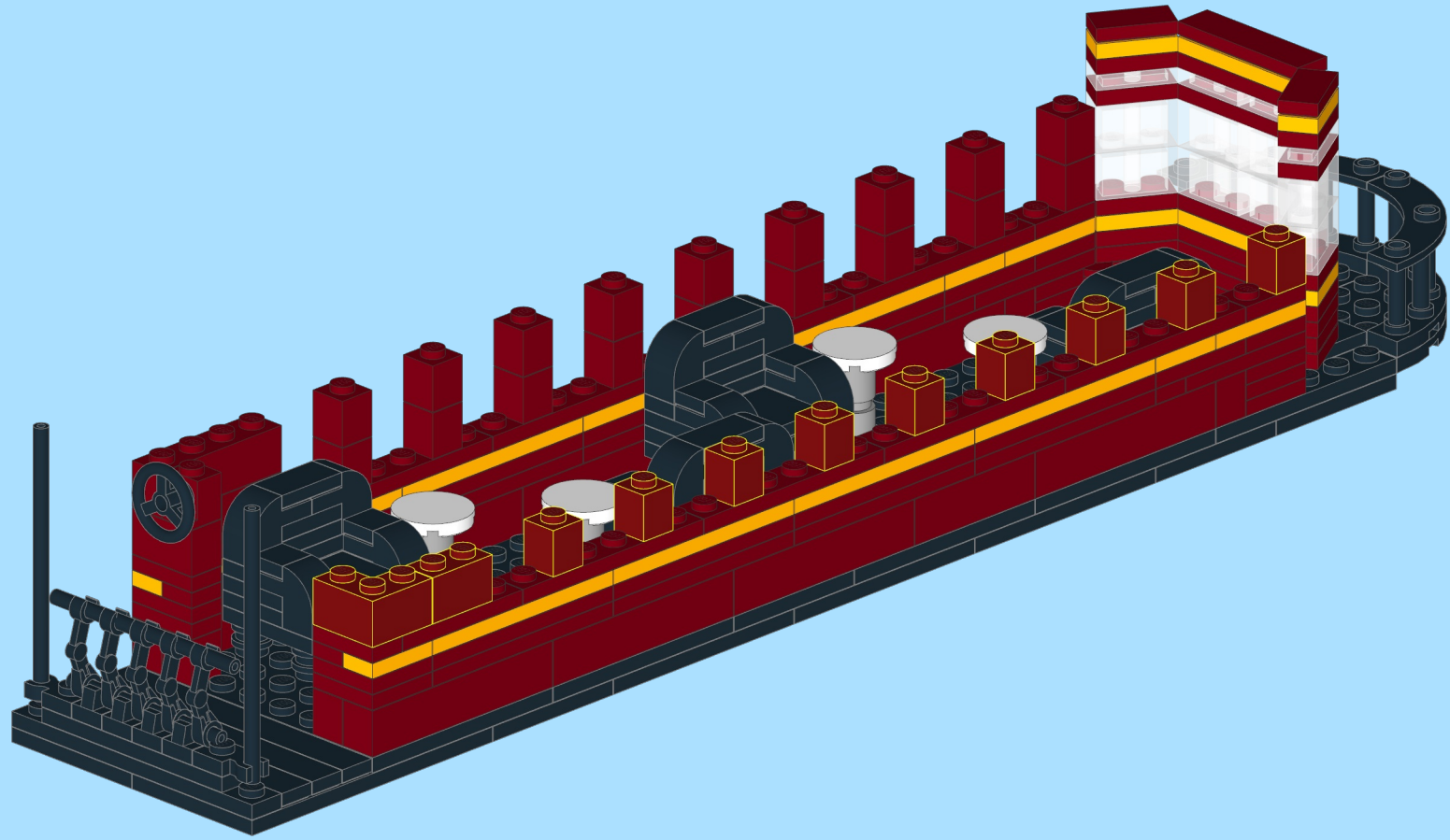
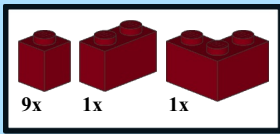



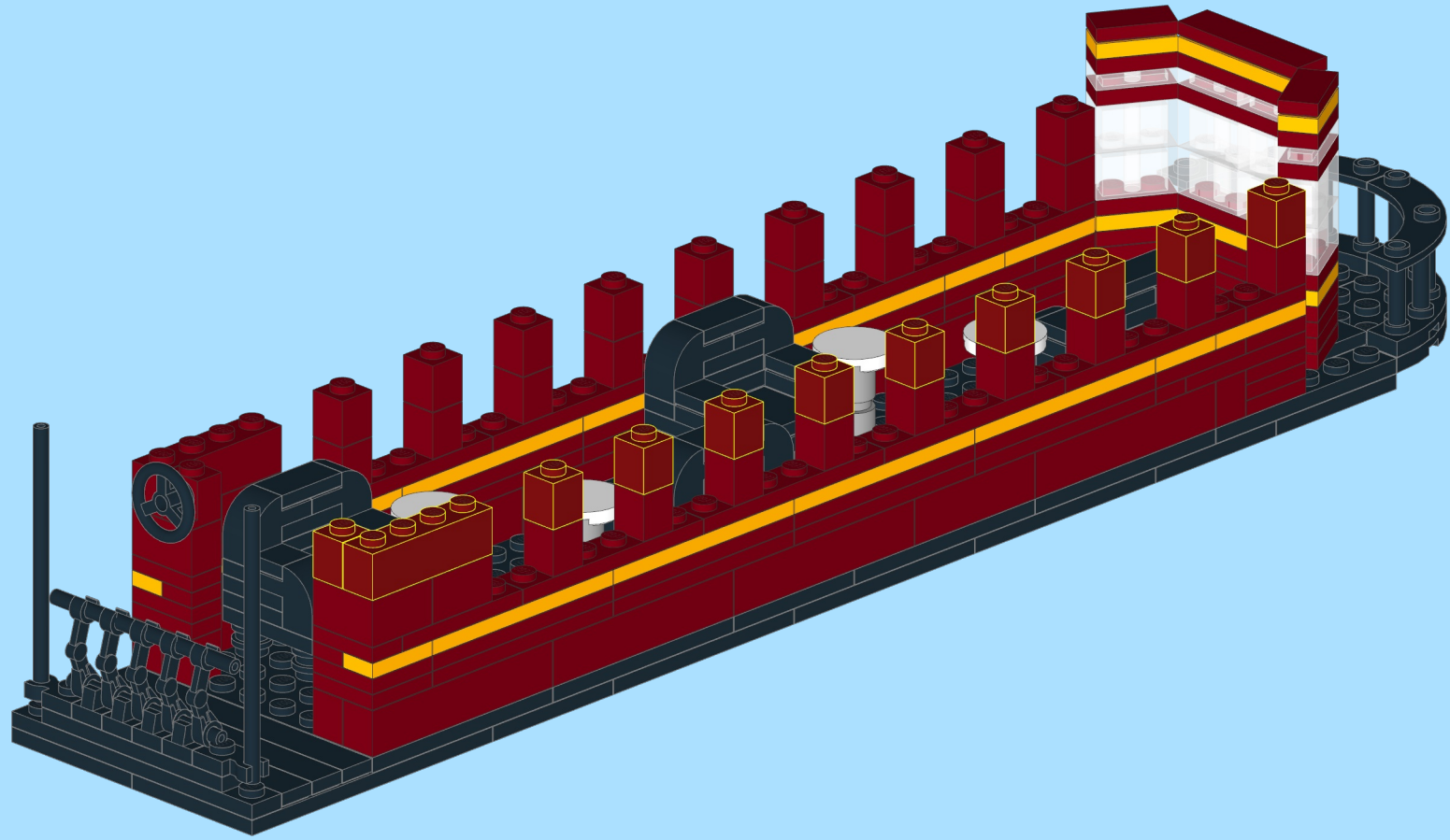
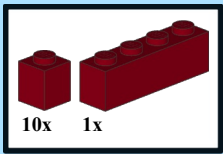

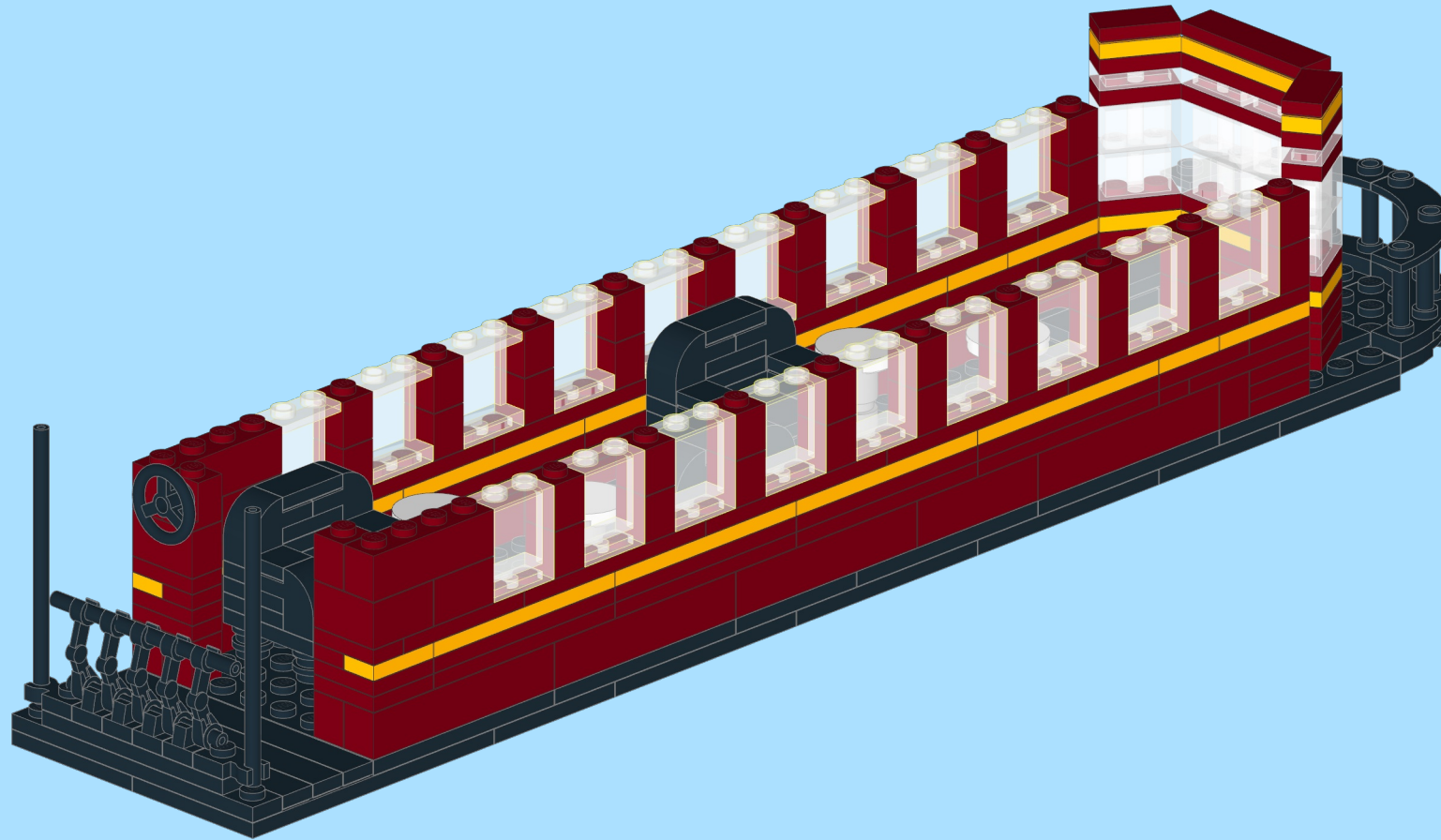

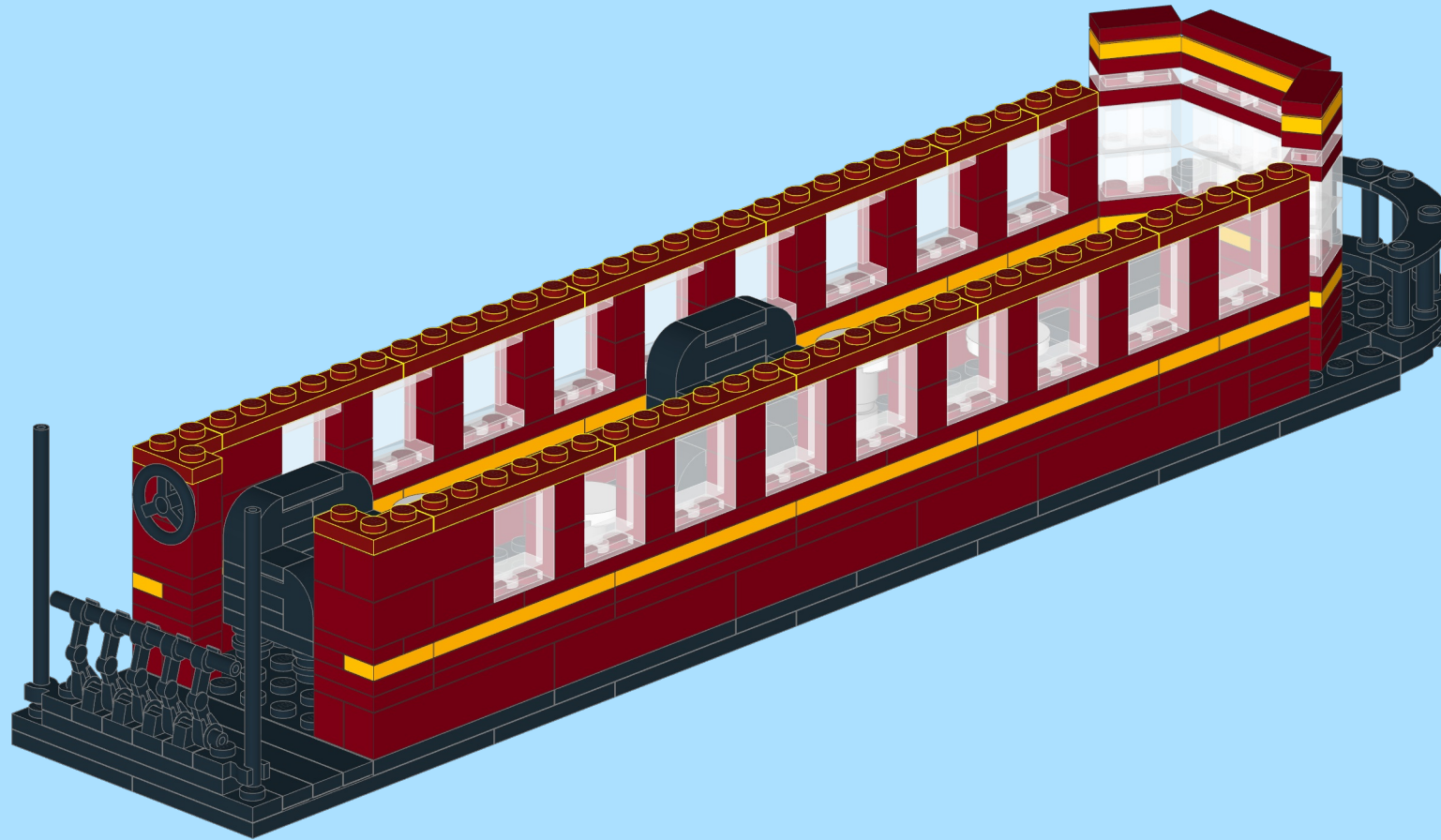
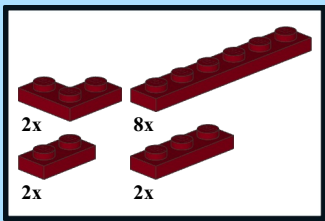

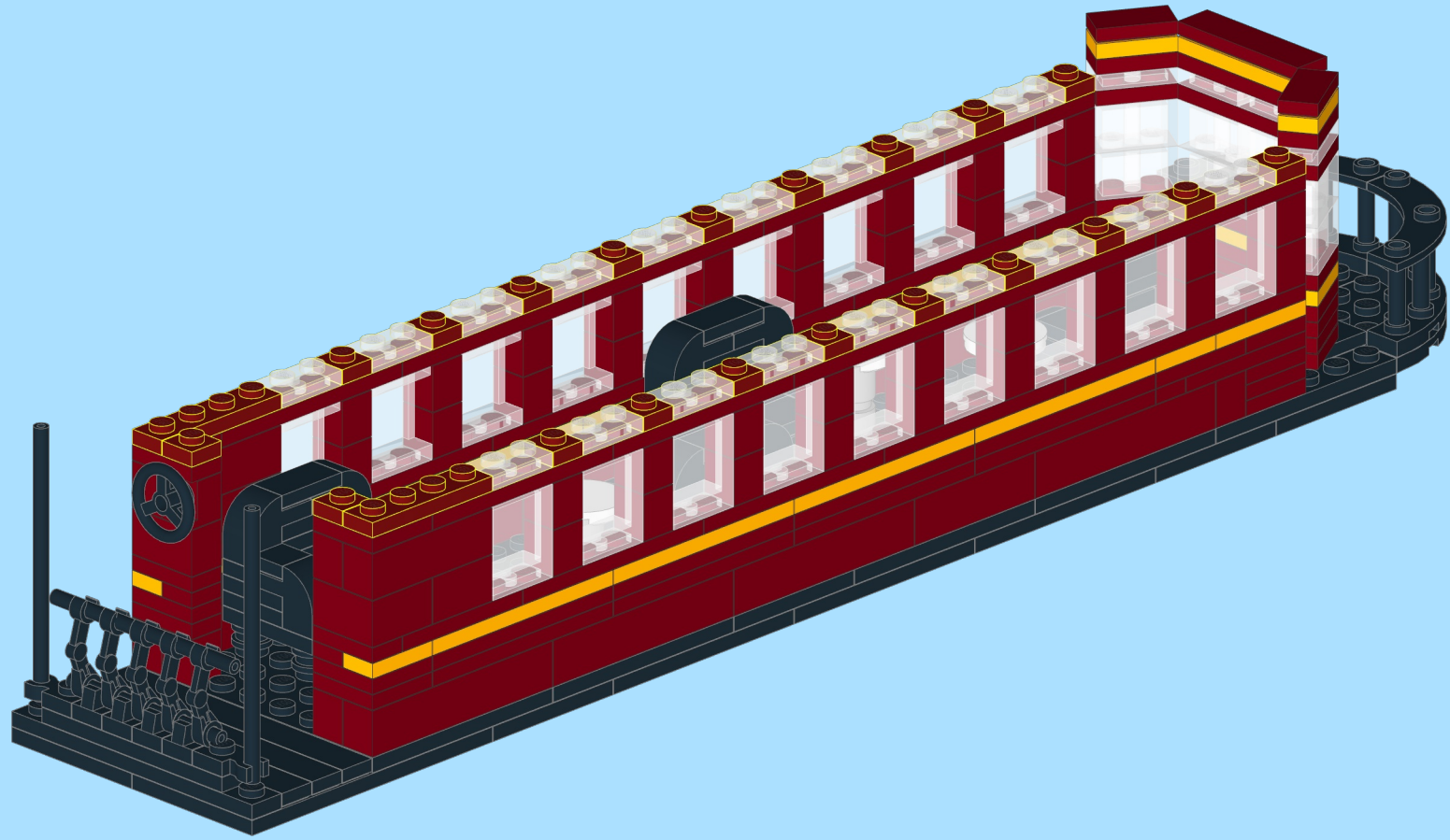
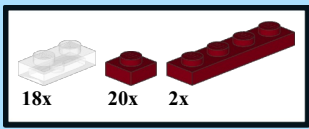

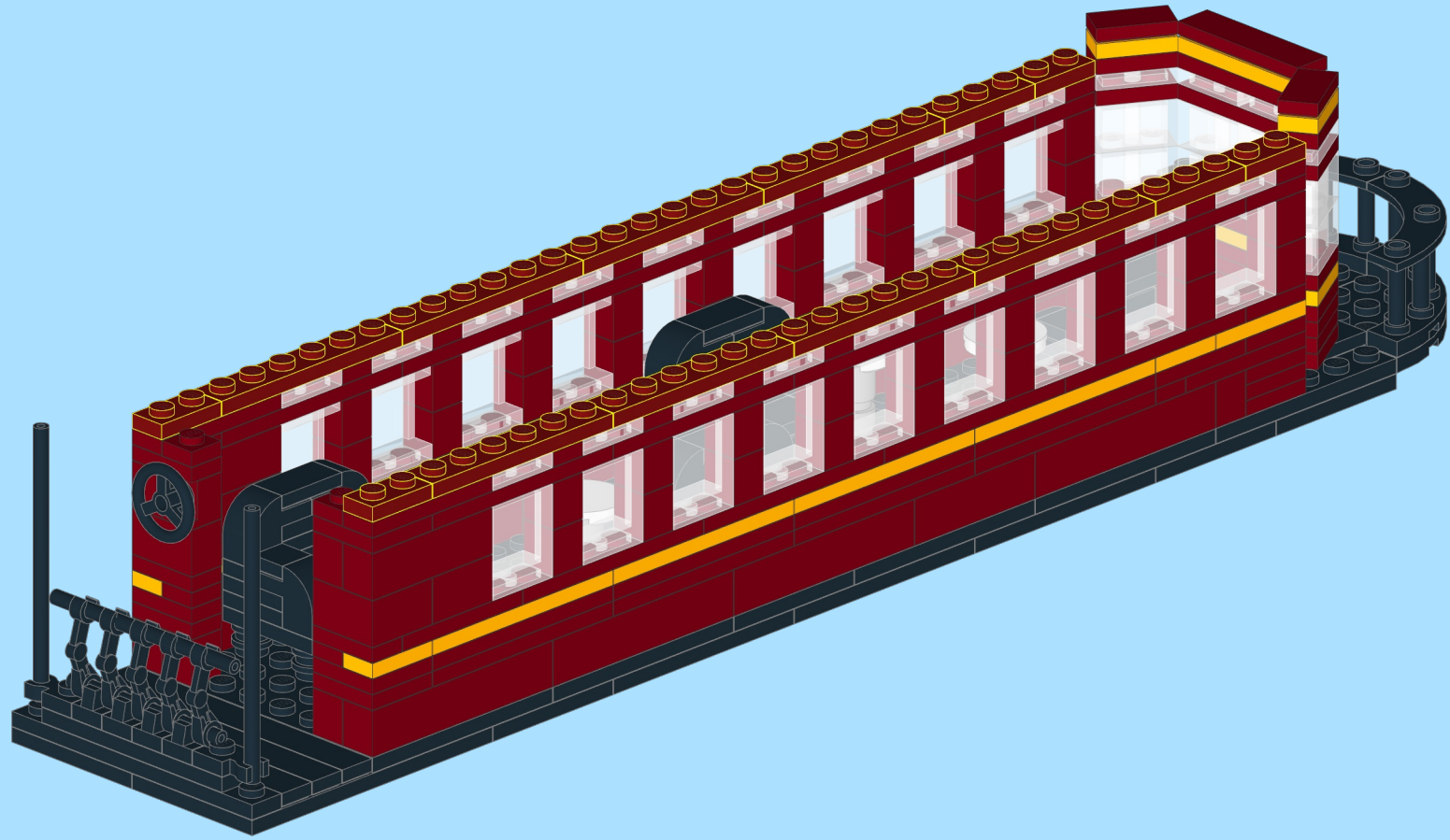
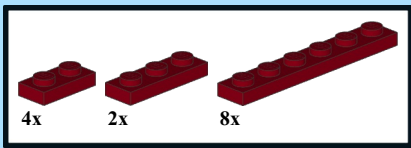

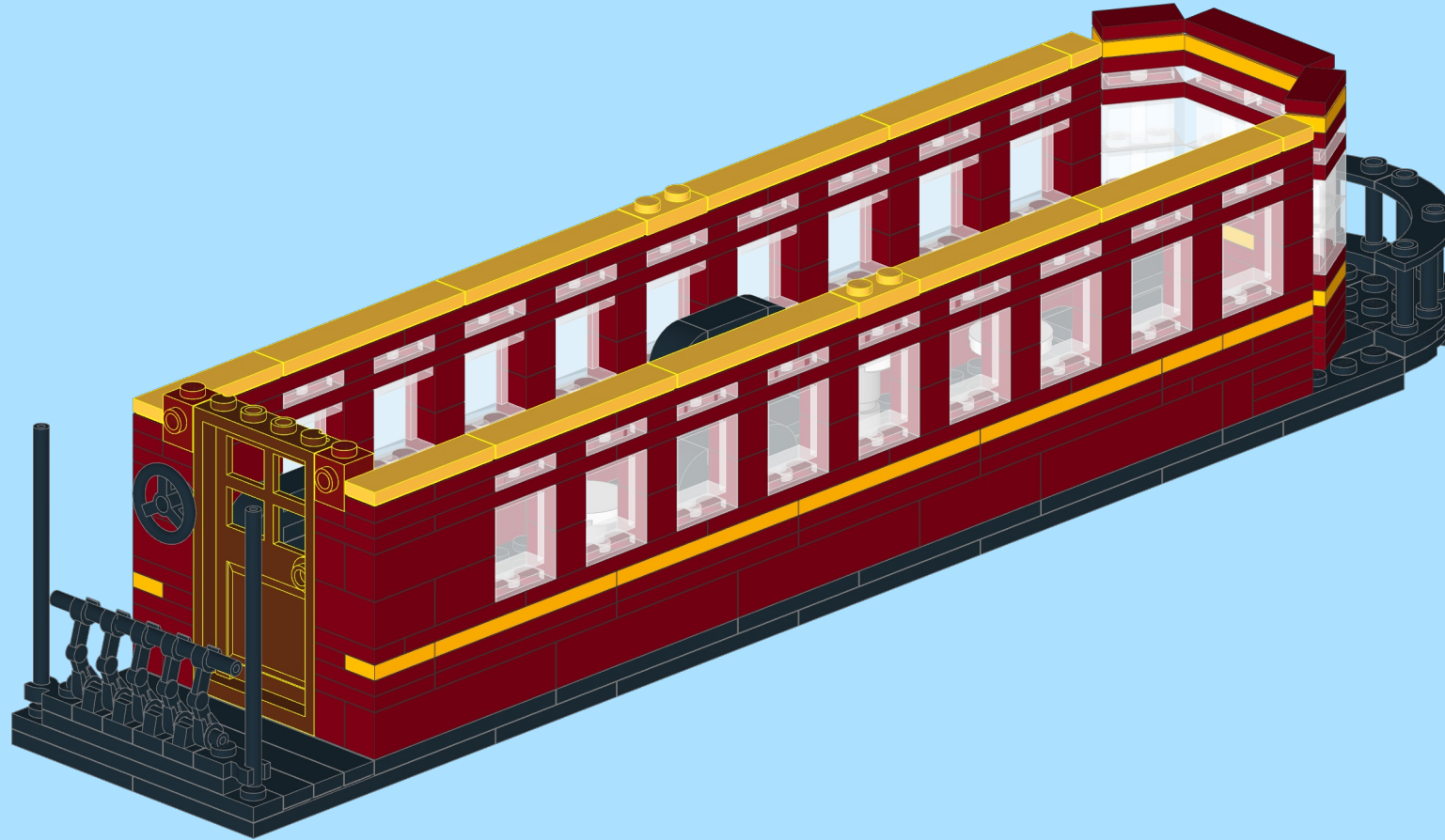
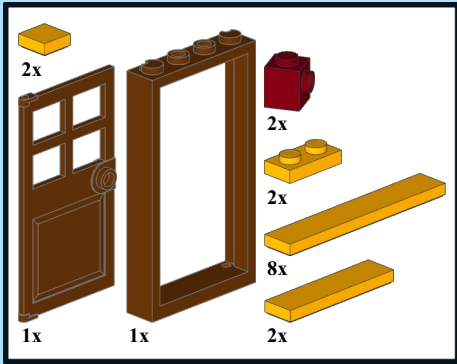

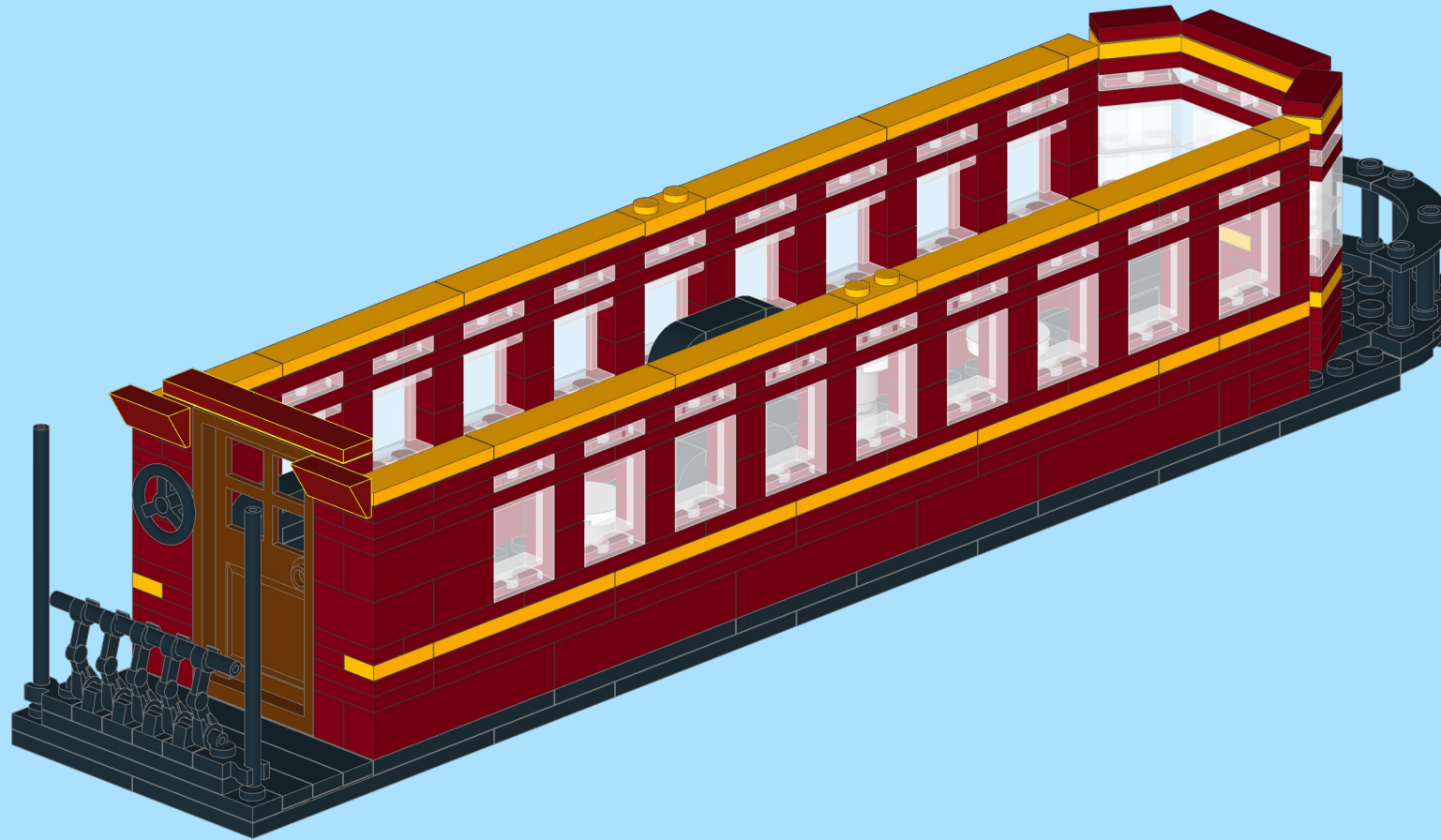
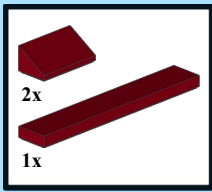

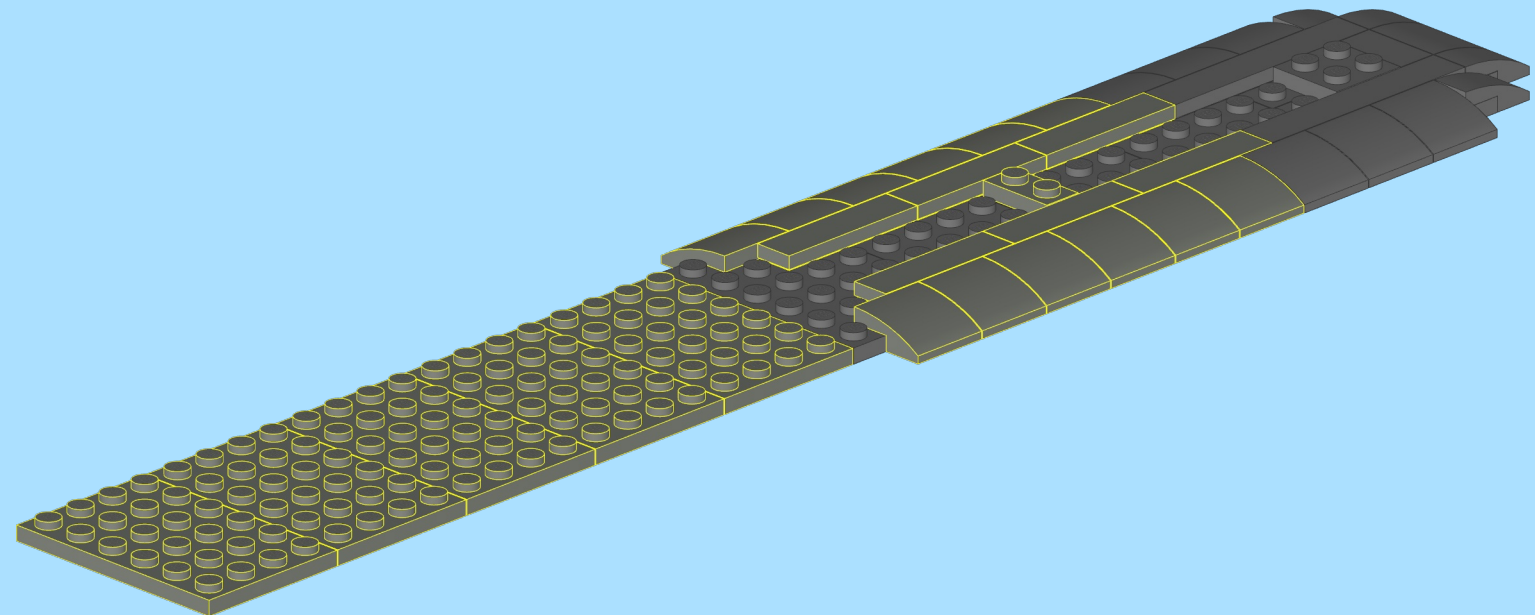
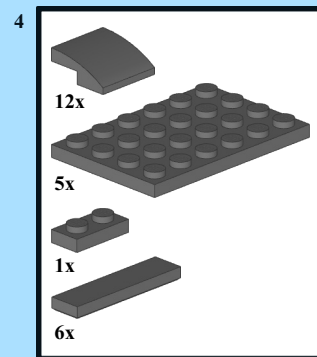
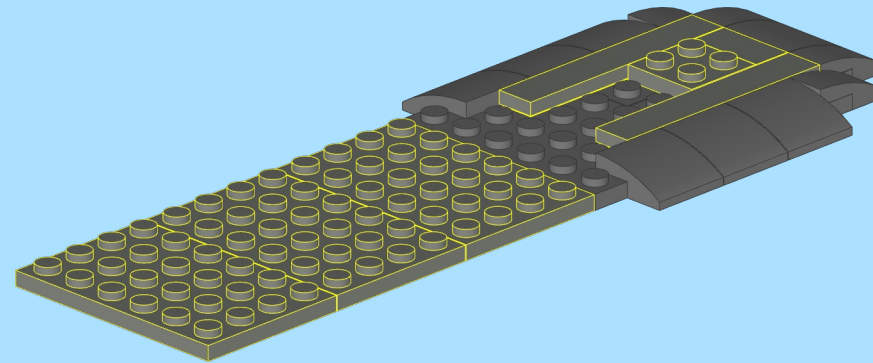
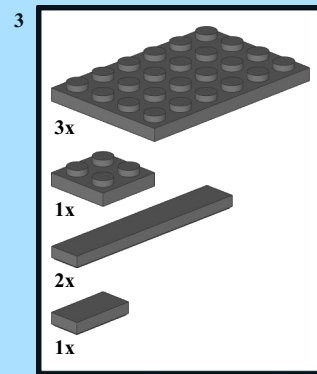
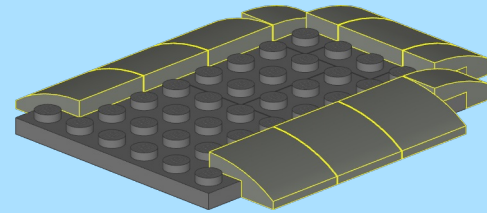
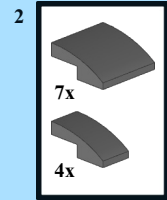
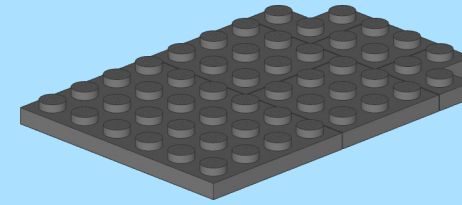
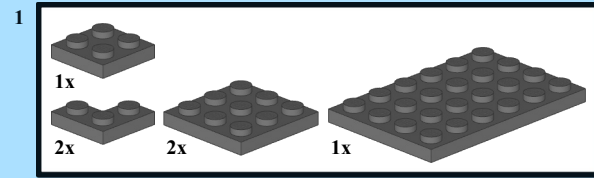





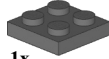





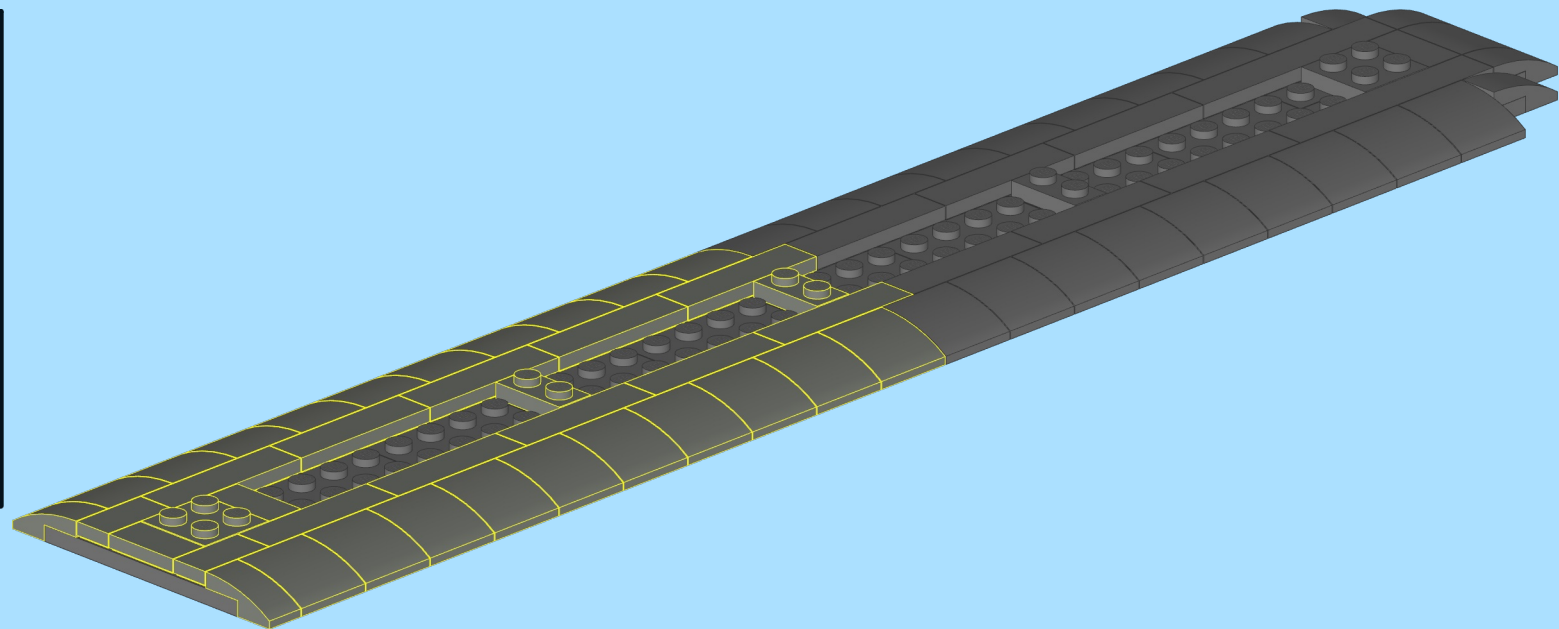







- 5
-  20x
  -  2x
  -  1x
  -  2x
  -  10x
  -  4x

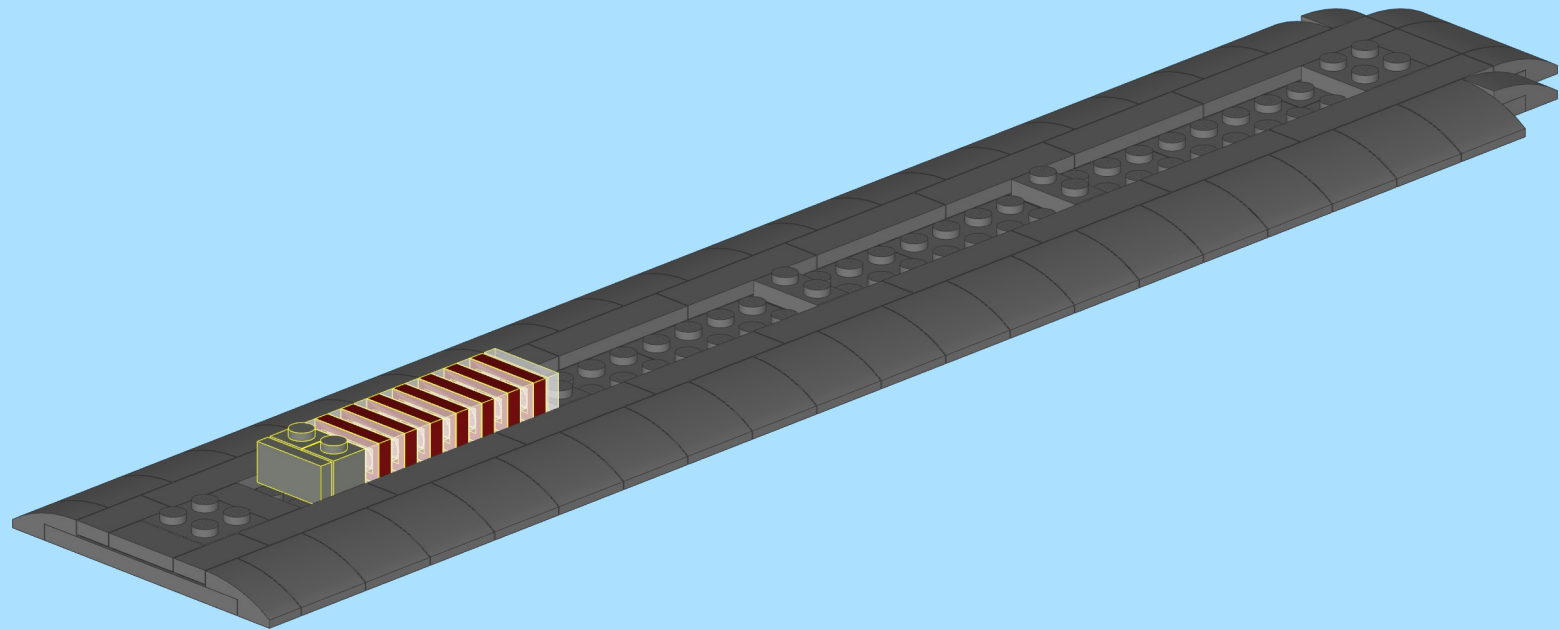



- 6
-  7x
  -  2x
  -  1x
  -  7x
  -  1x

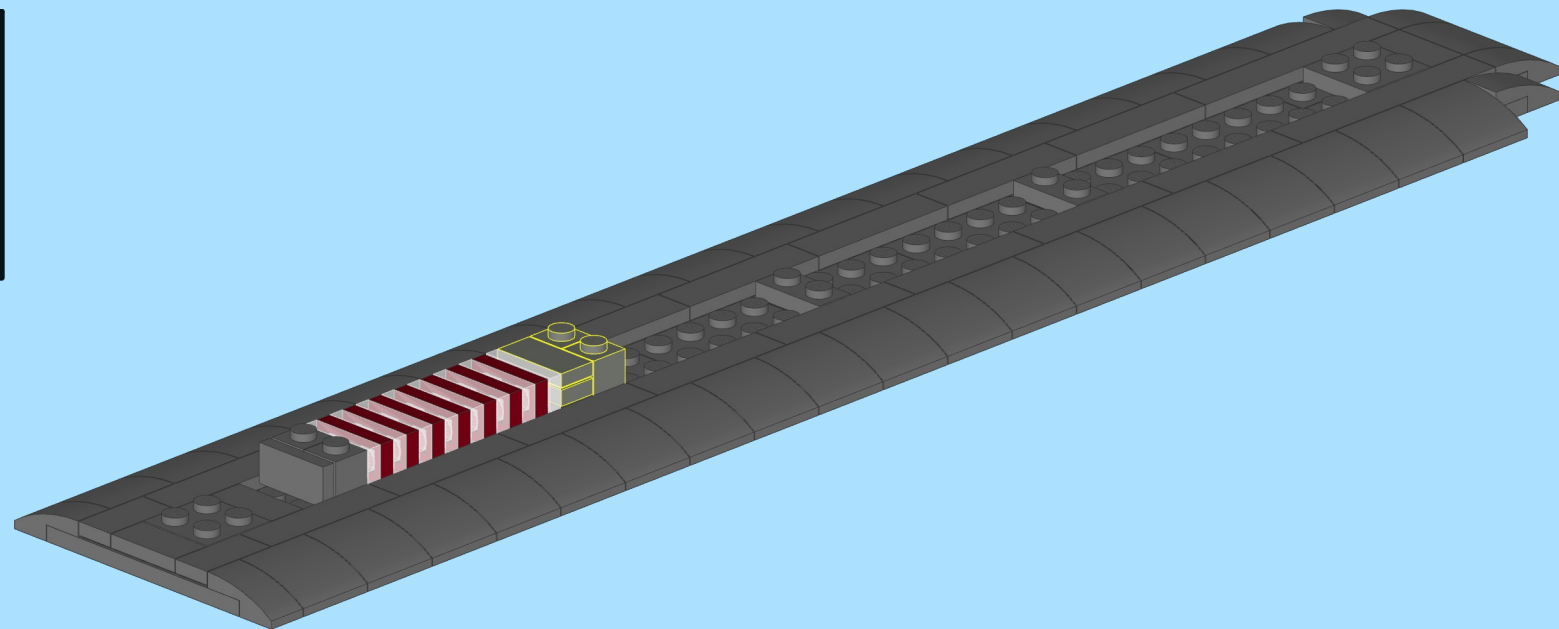

- 7
-  1x
  -  2x
  -  1x



- 8
-  7x
  -  7x
  -  1x

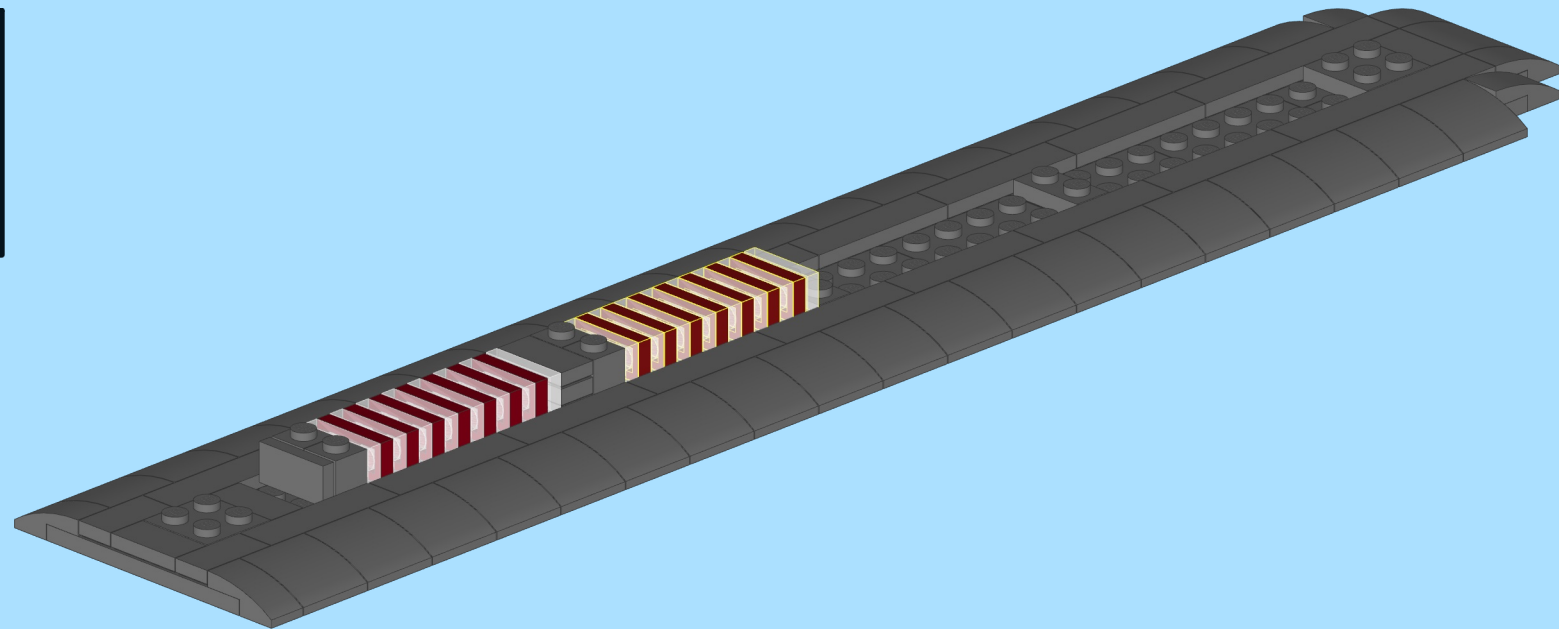

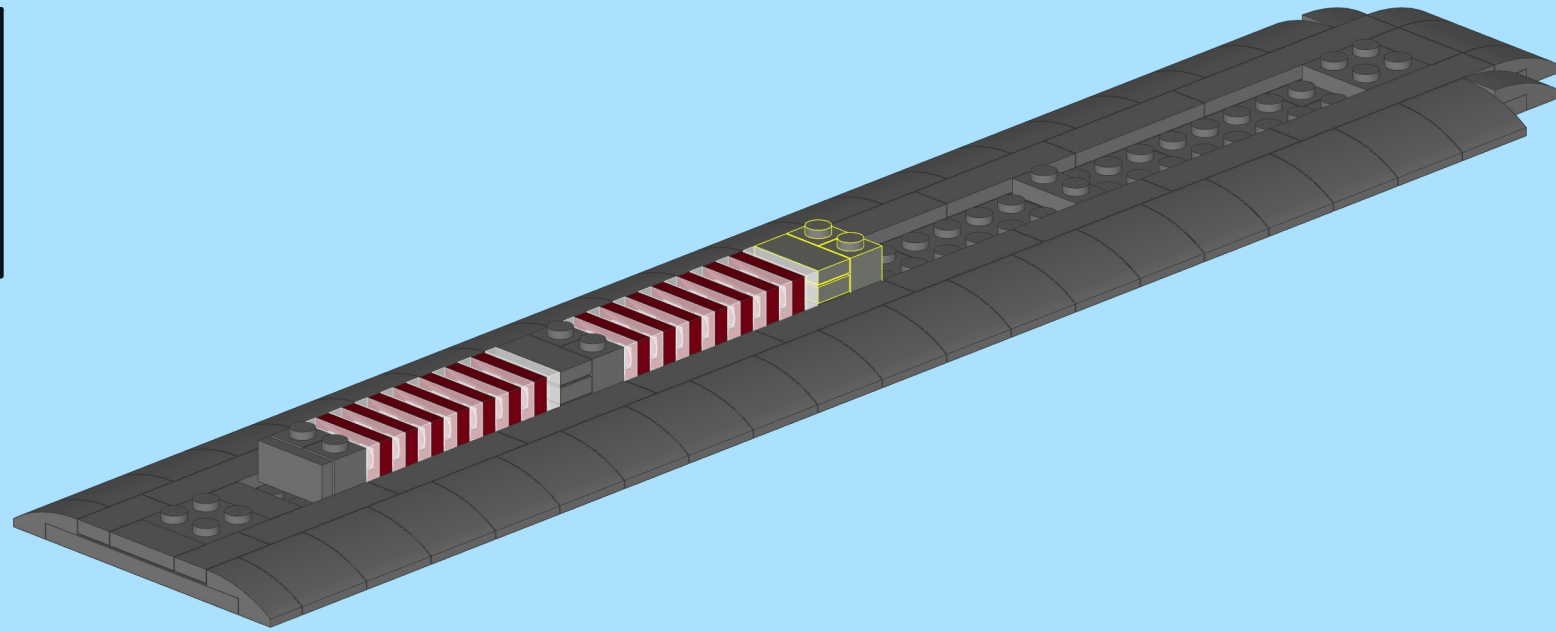
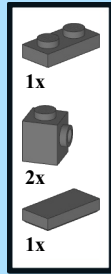

9



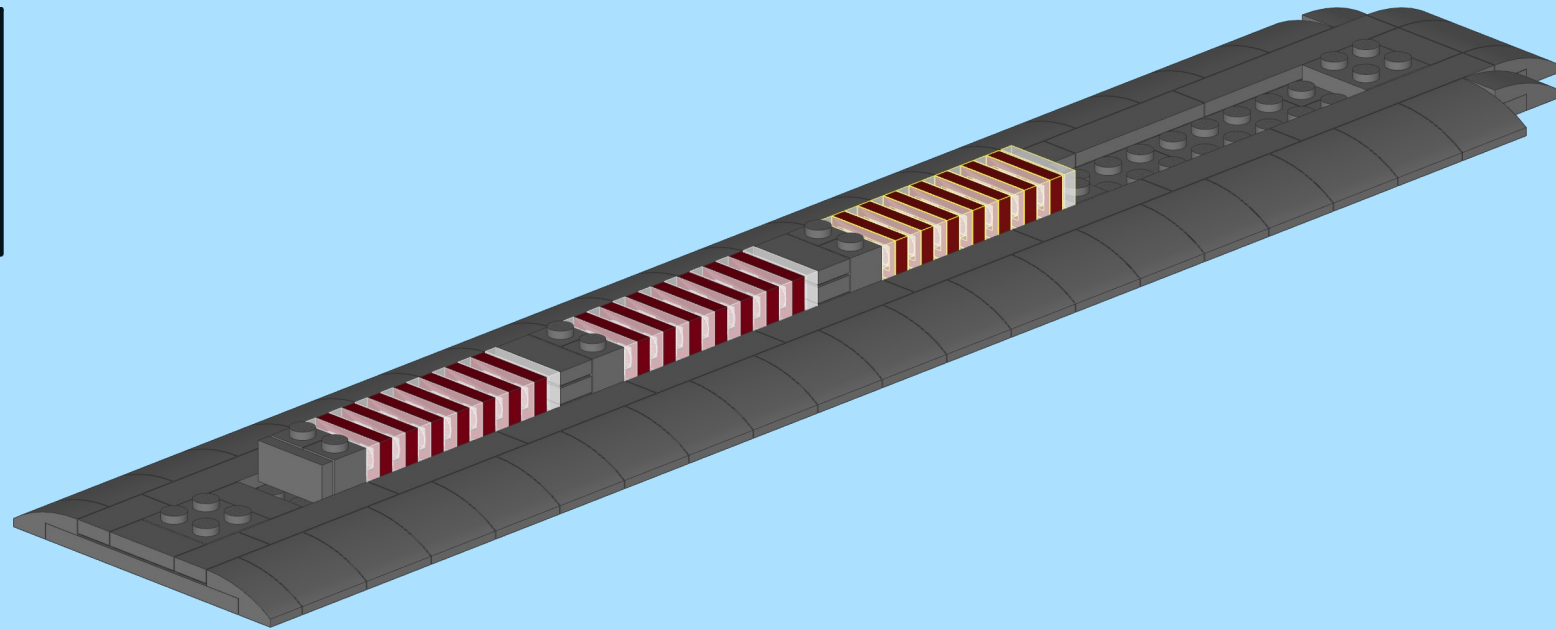
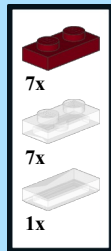

10

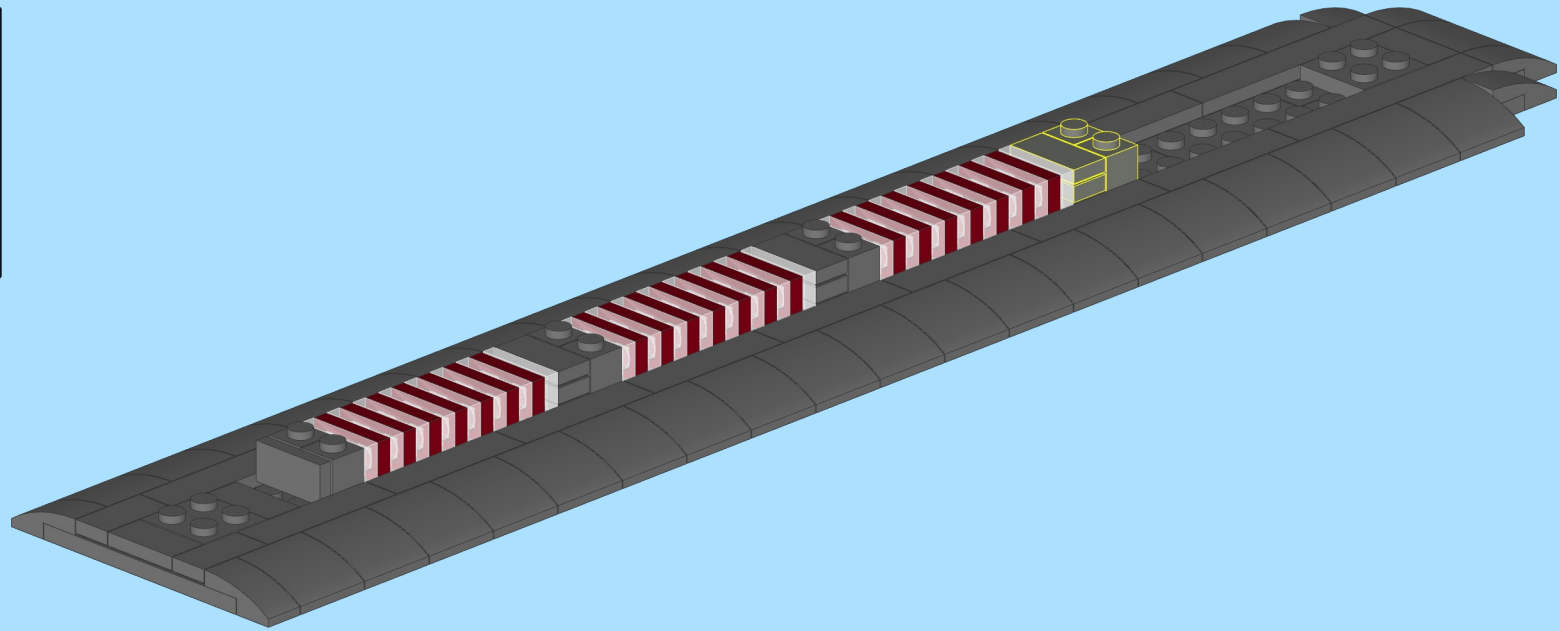

- 11
-  1x
  -  2x
  -  1x



- 12
-  7x
  -  1x
  -  8x

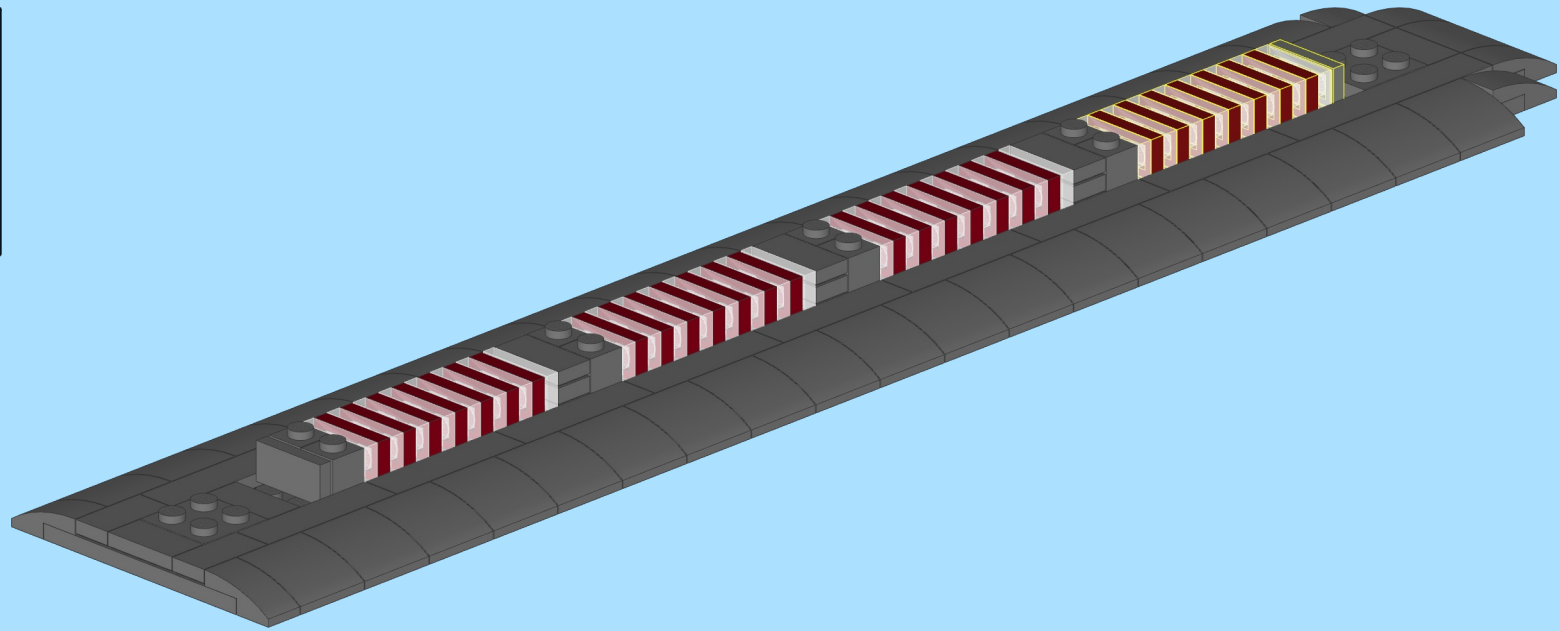

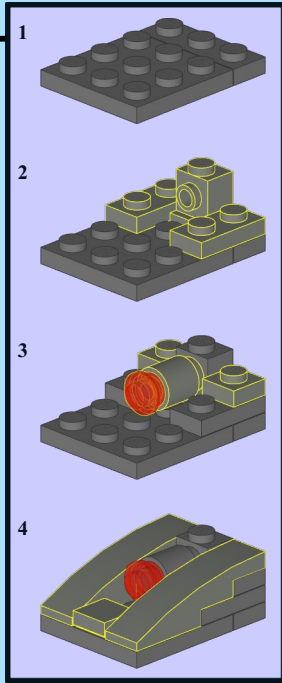
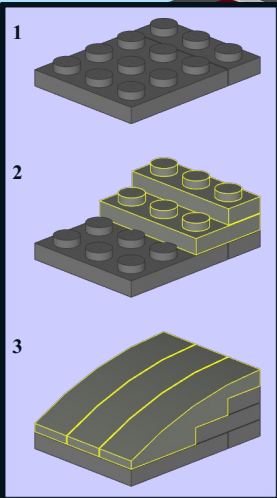
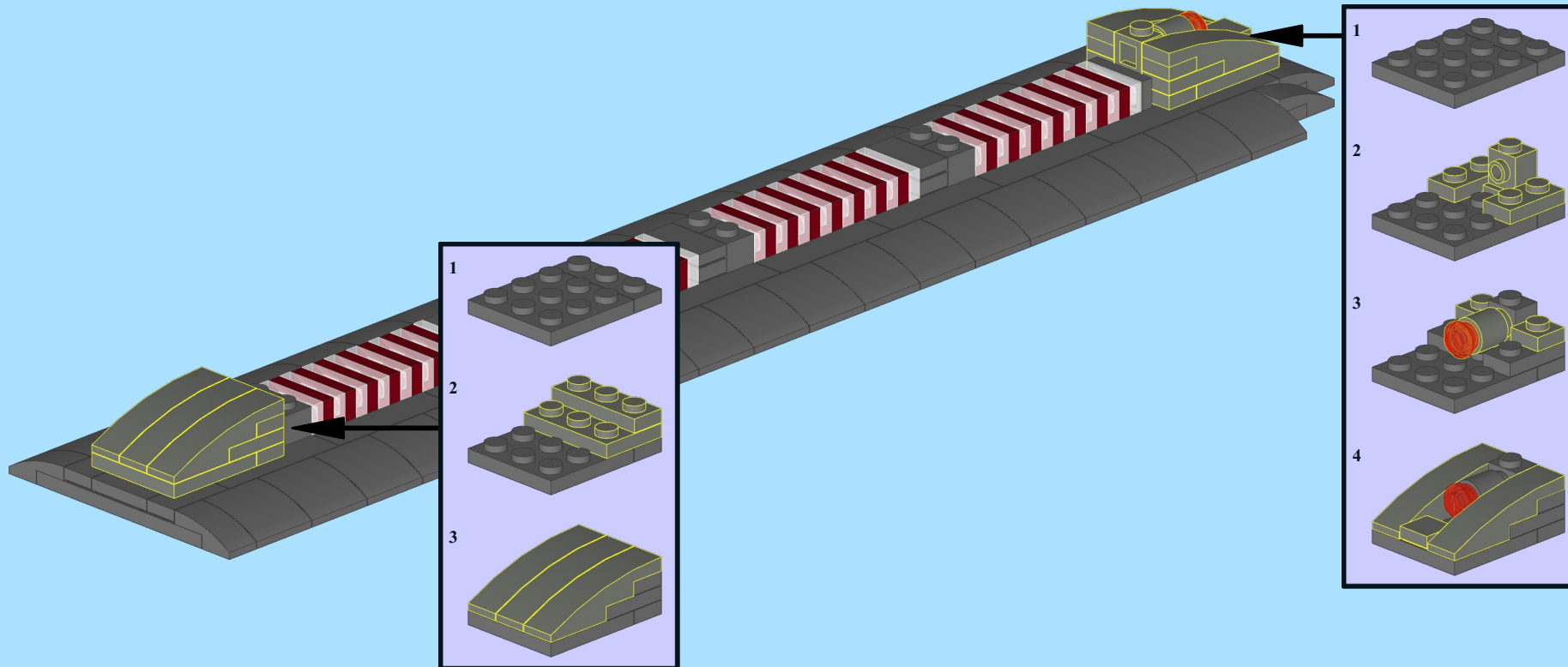
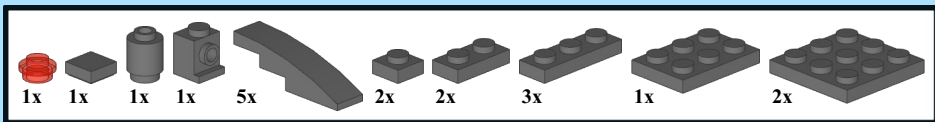

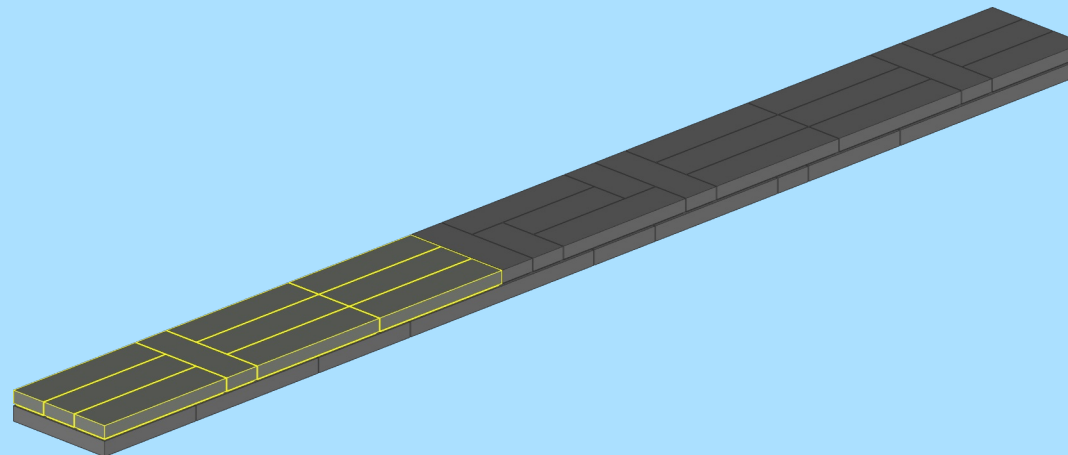
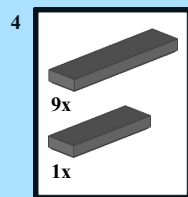
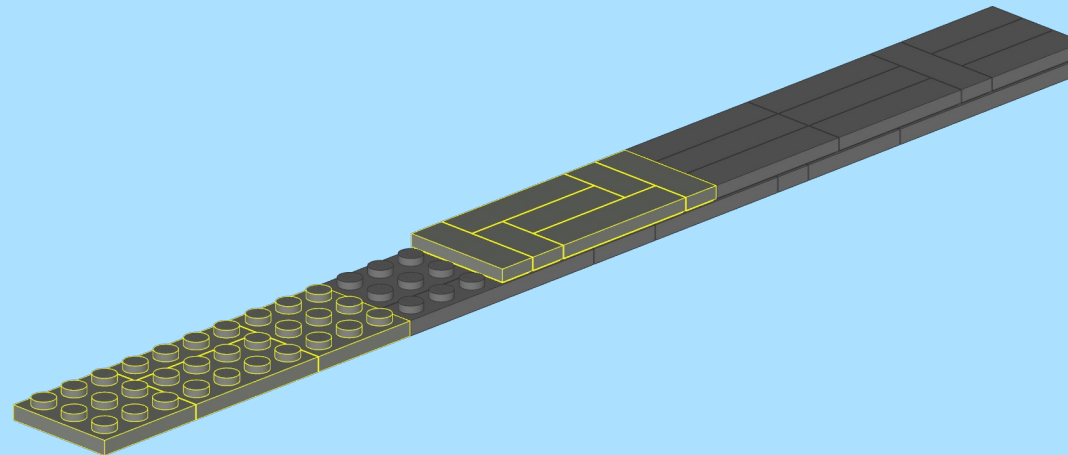
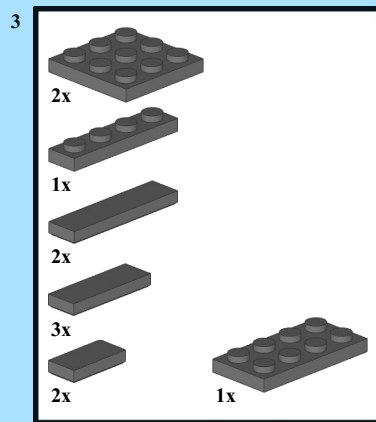
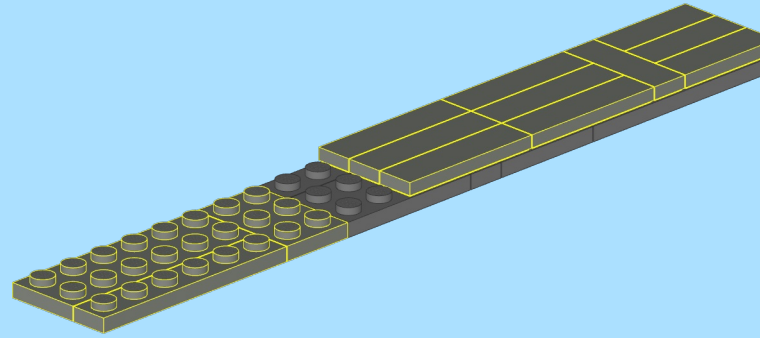
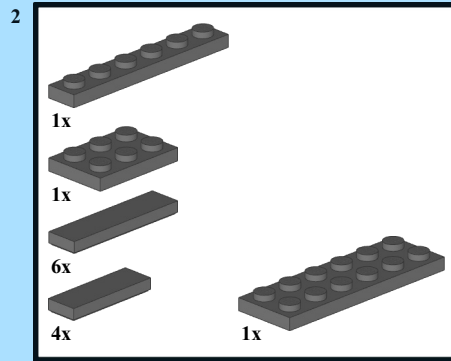
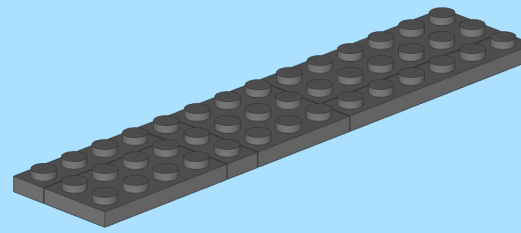
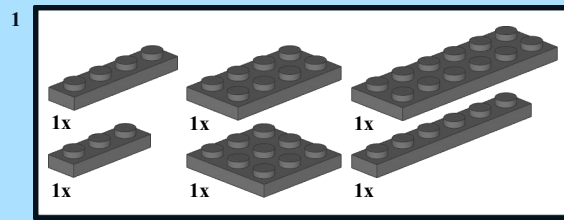

14

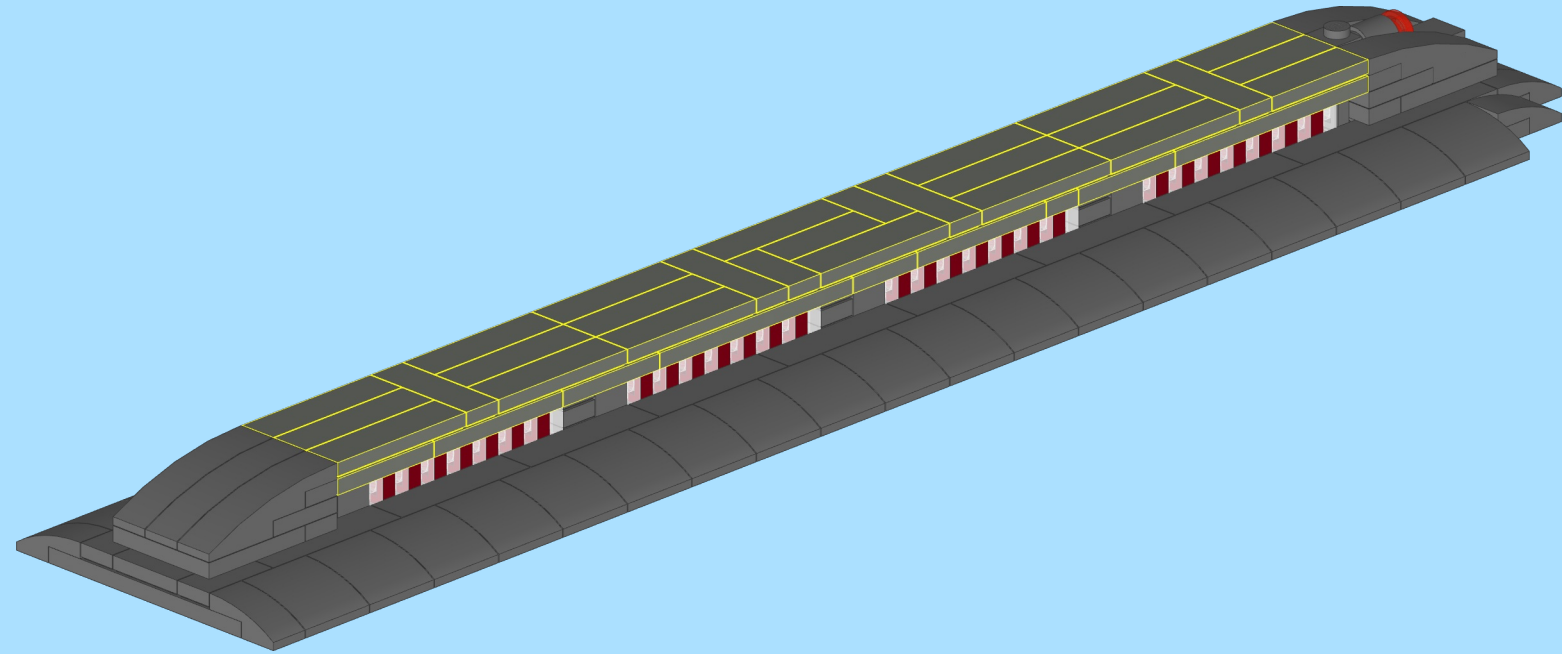

15

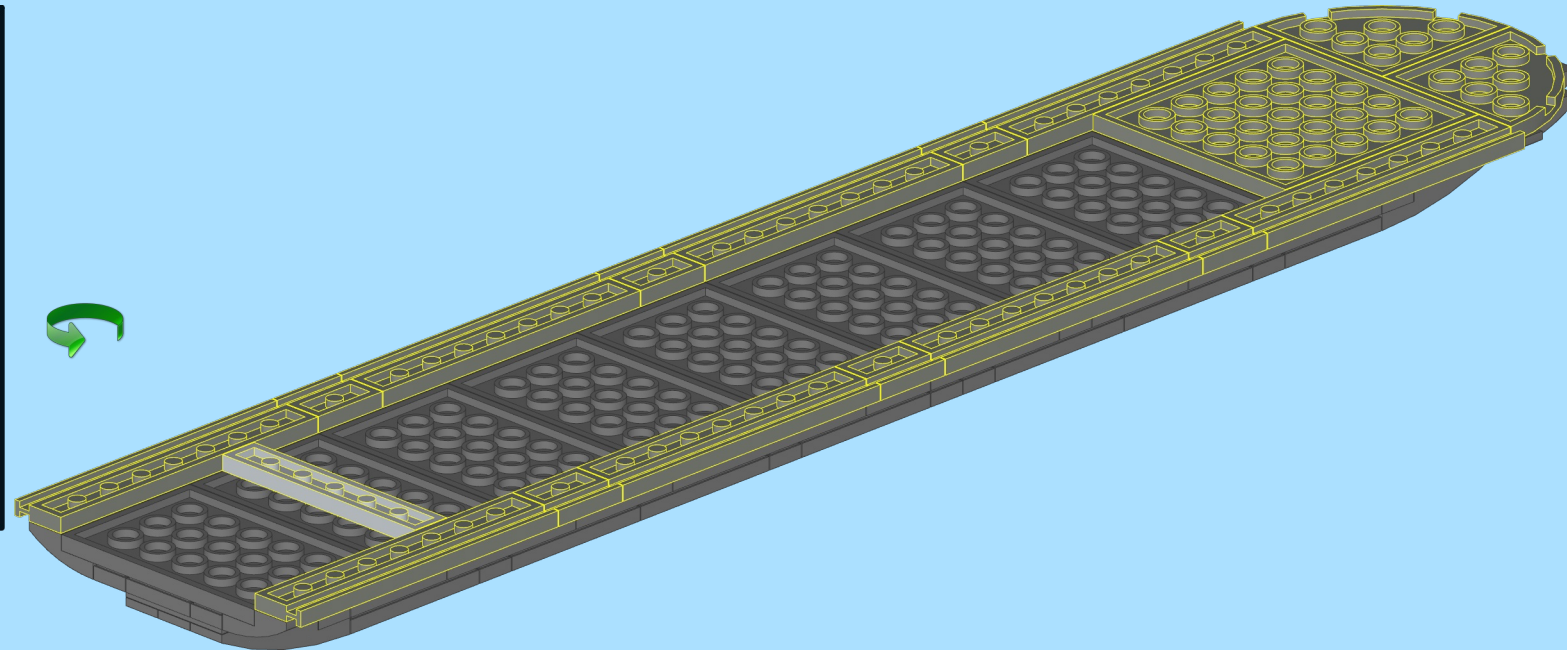
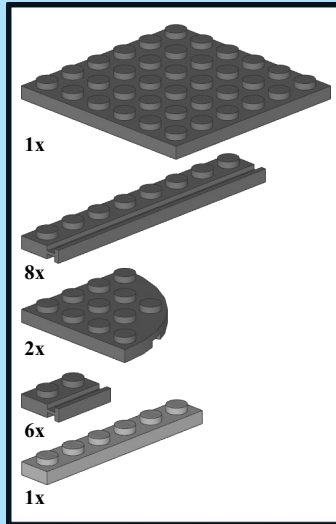

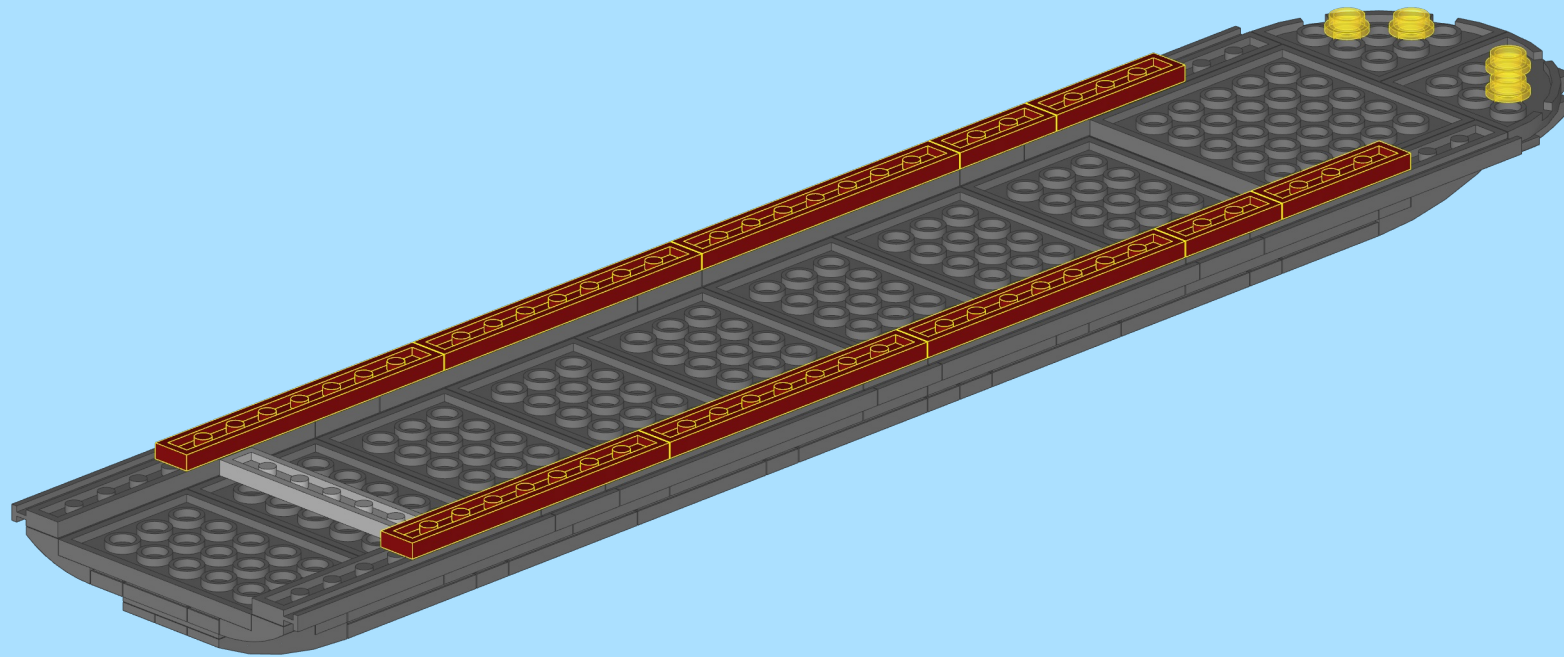
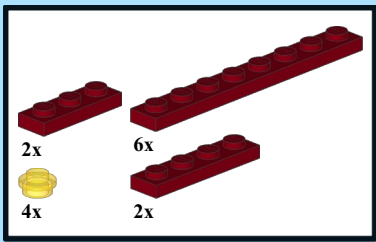



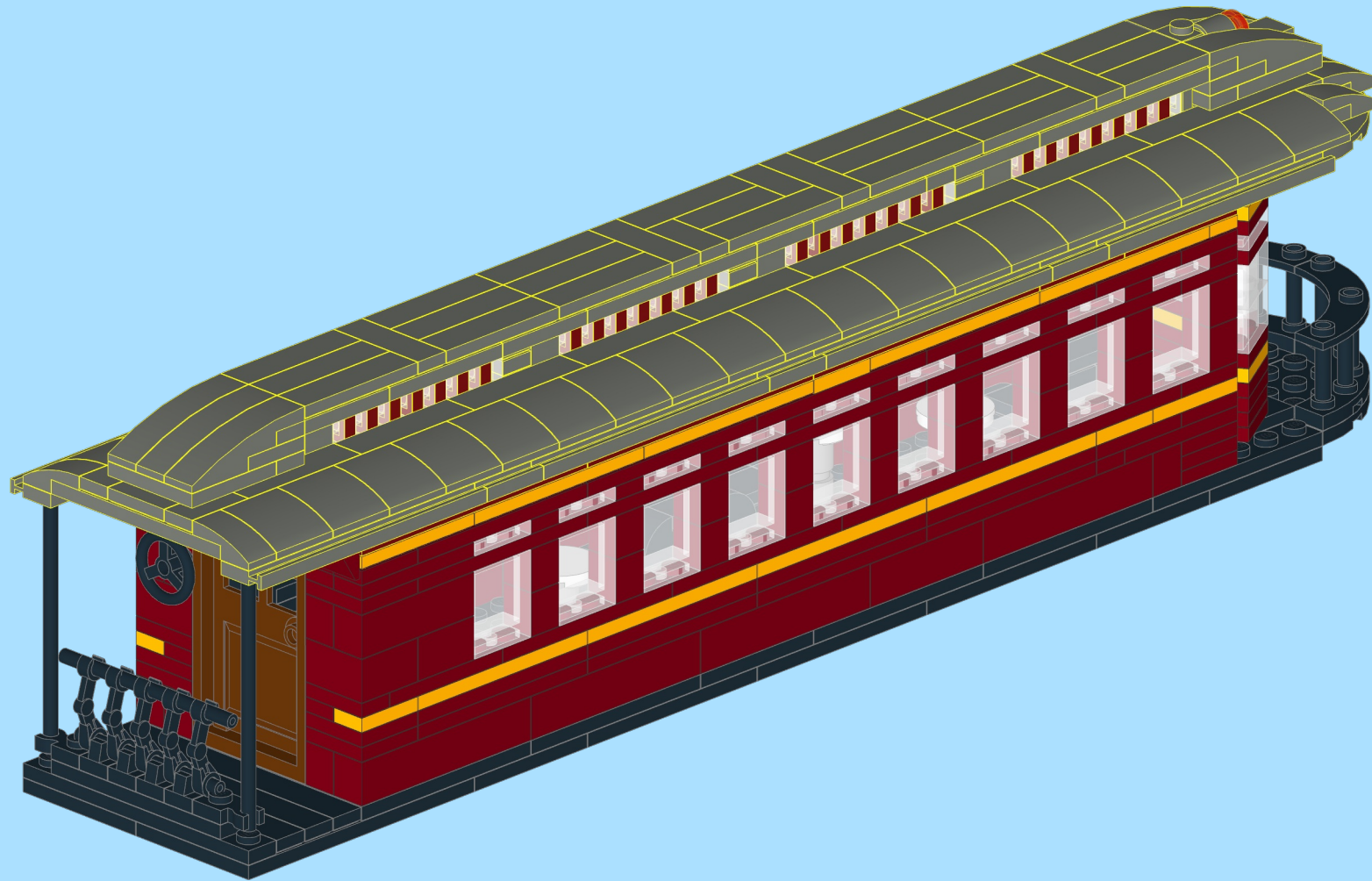

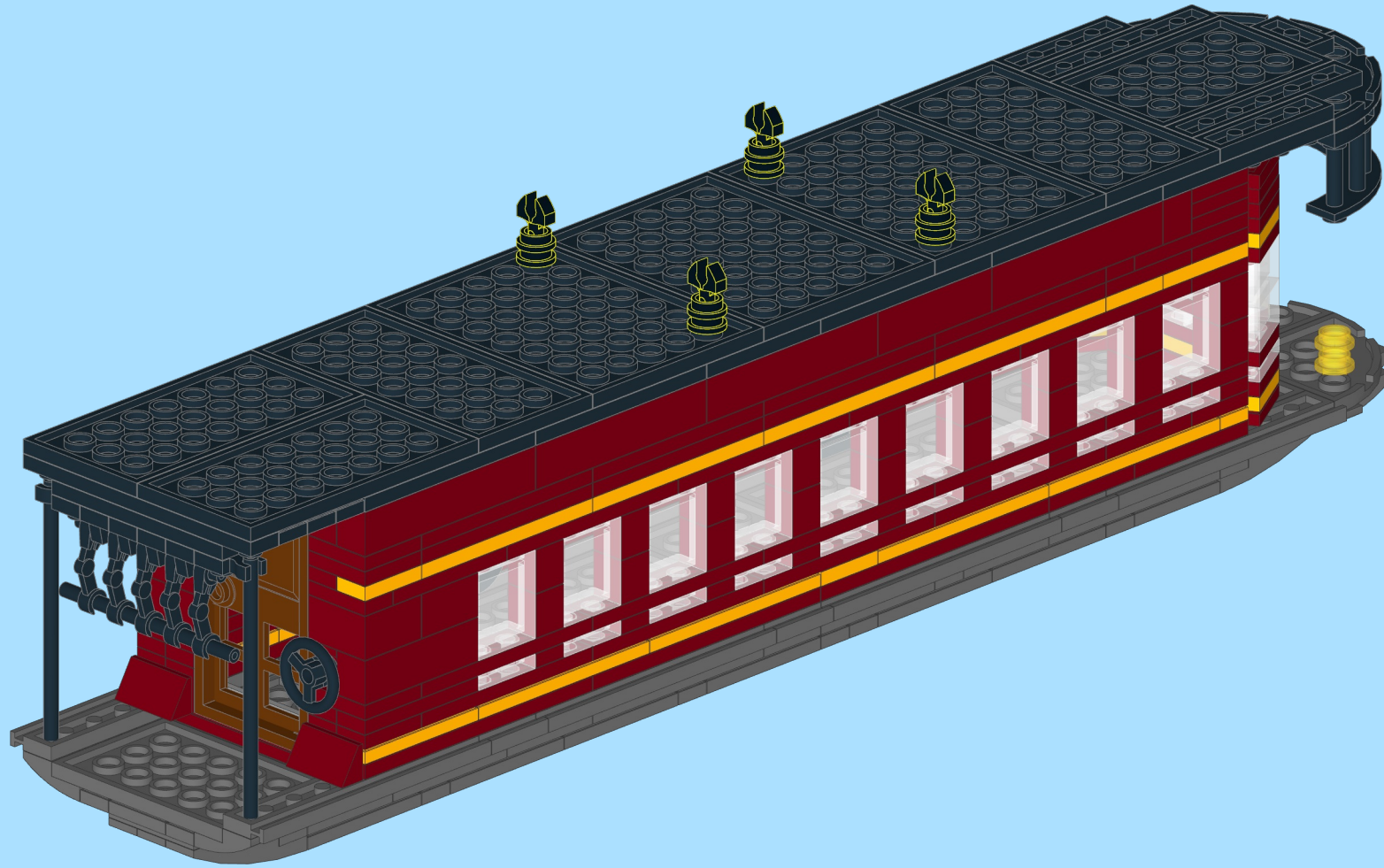

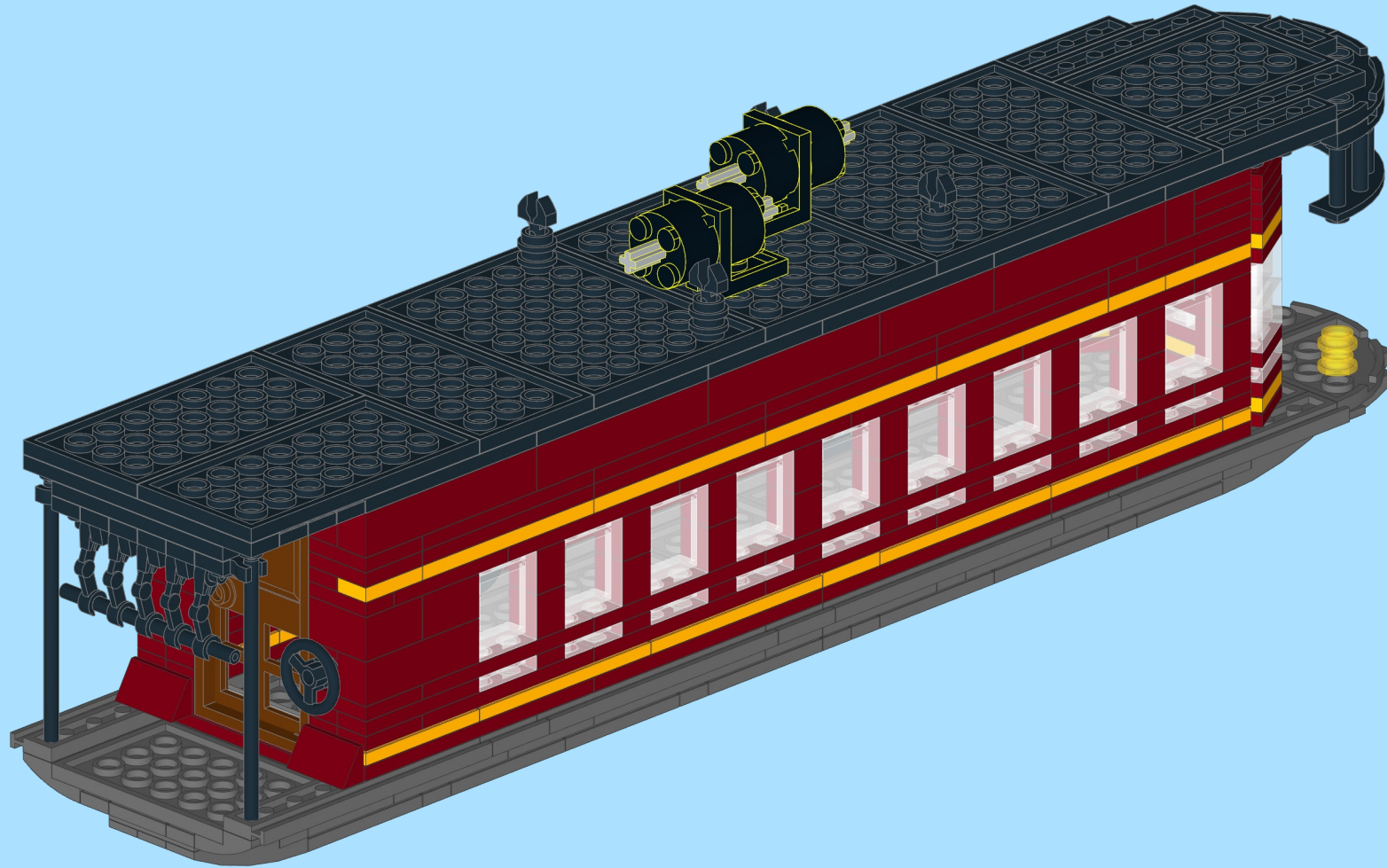
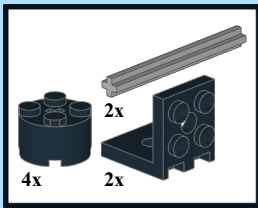

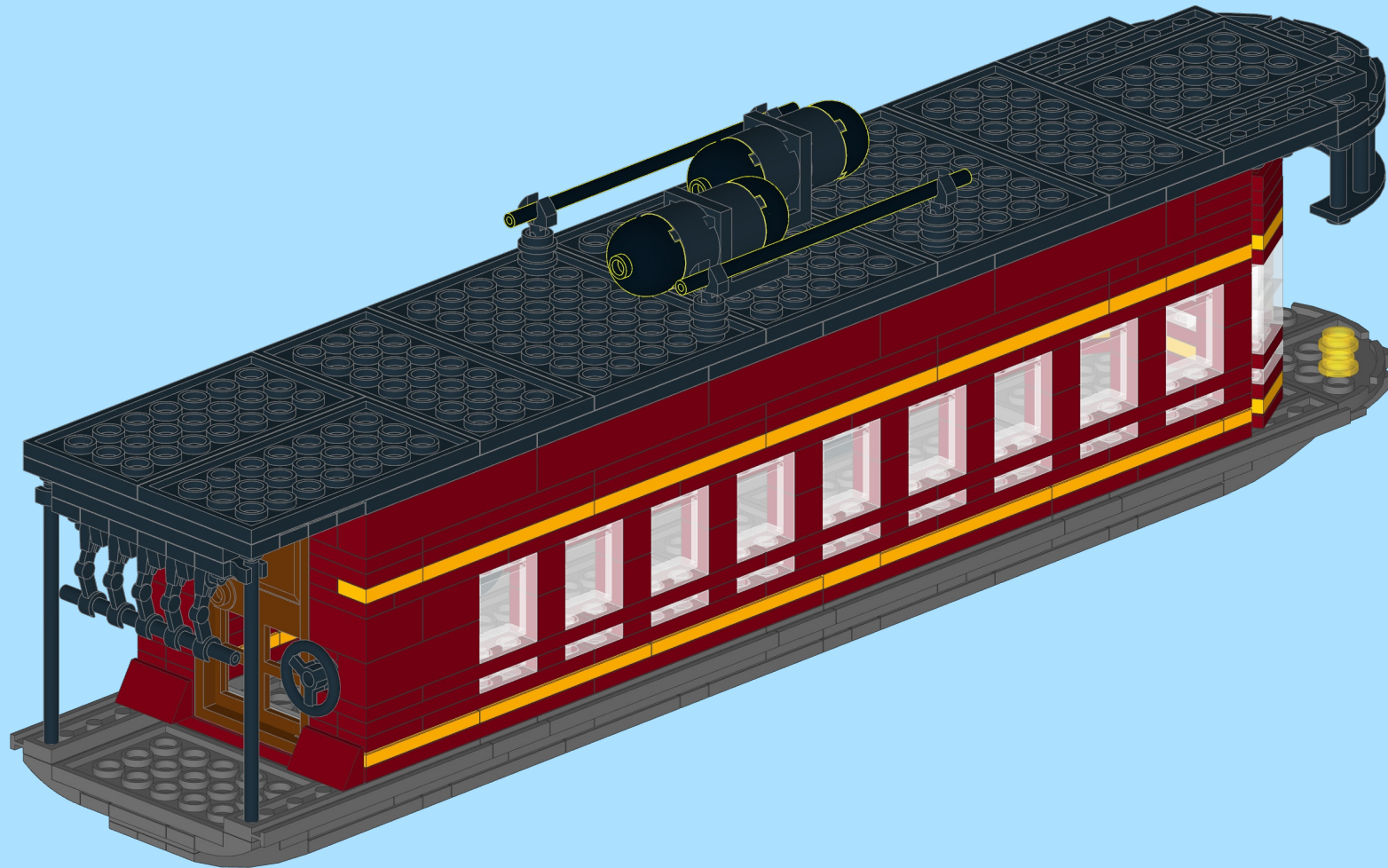

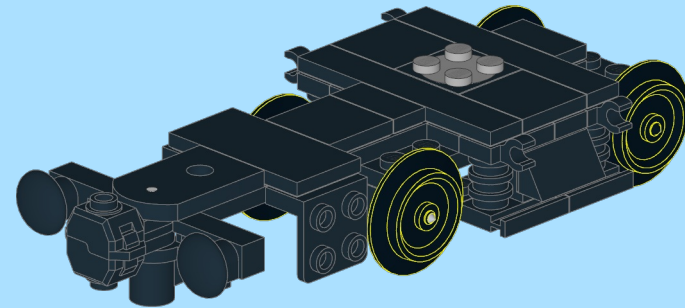
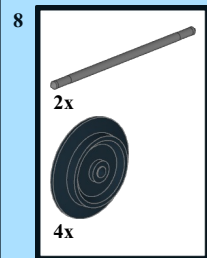
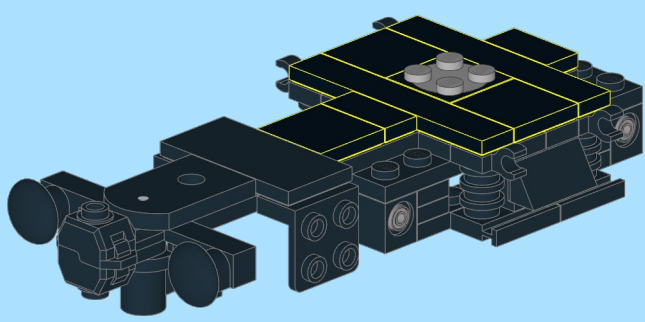
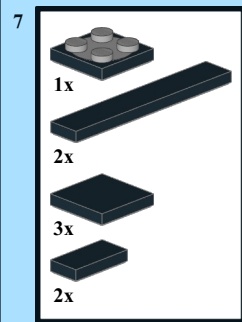
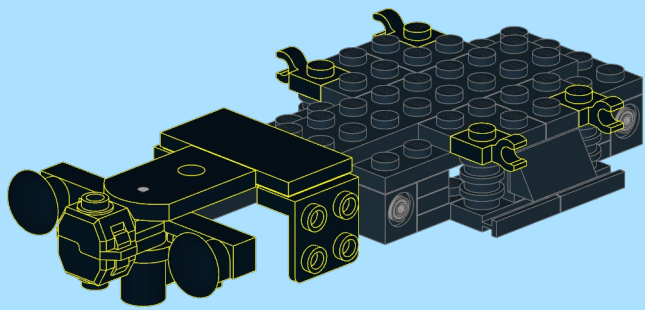
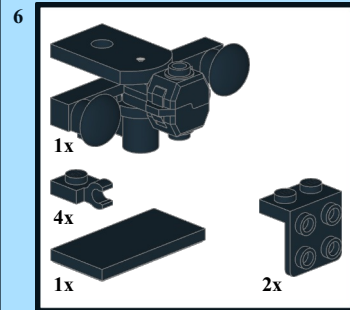
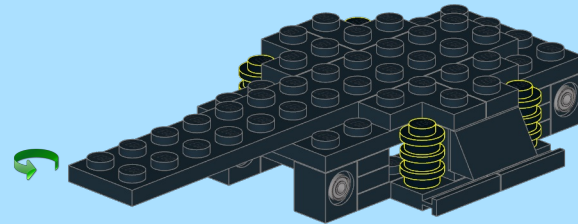
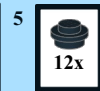
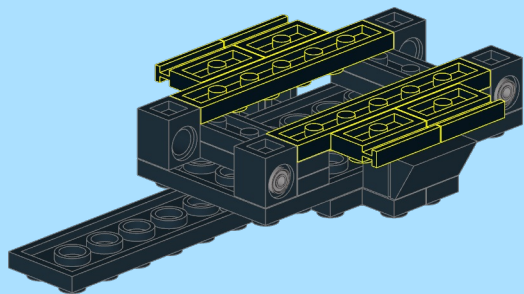
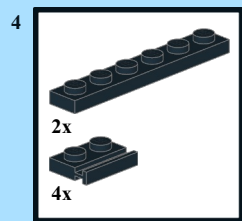
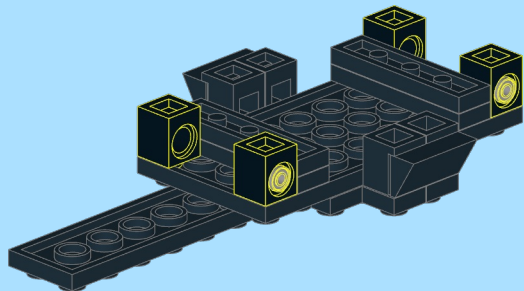
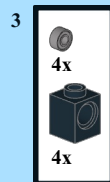
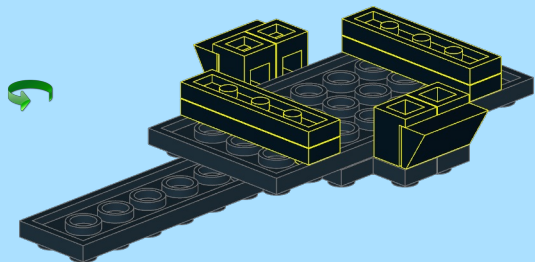
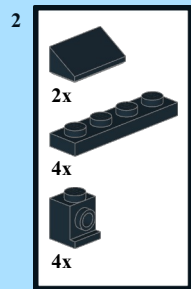
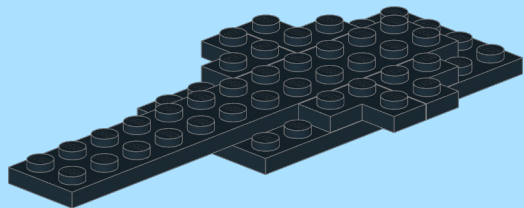
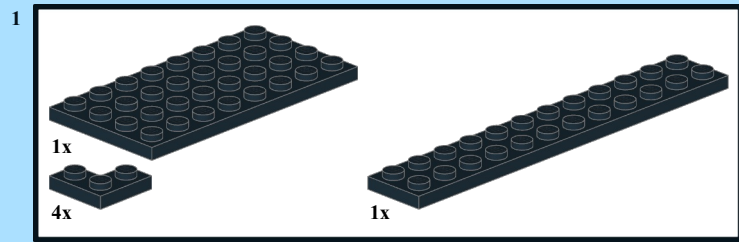

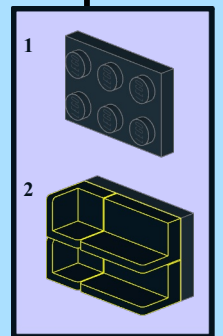
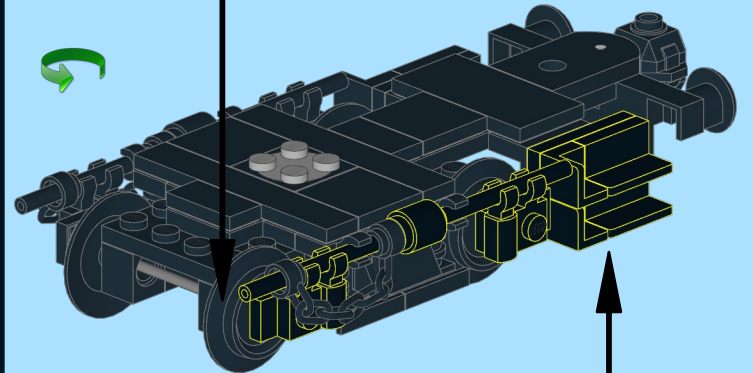
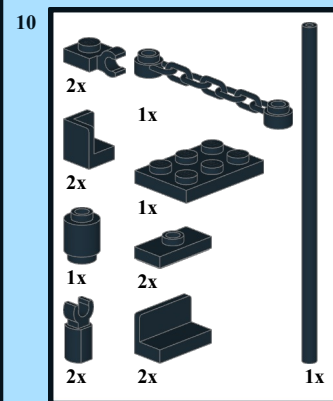
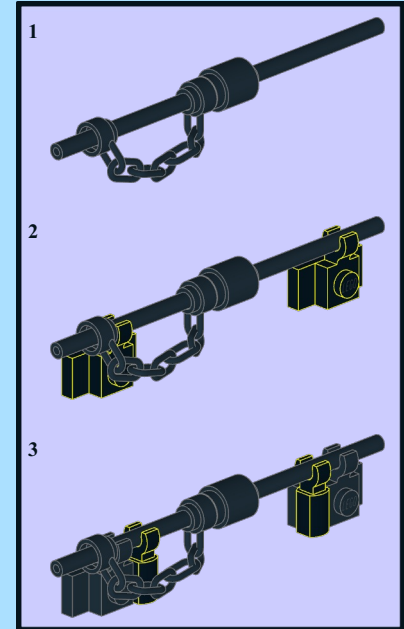
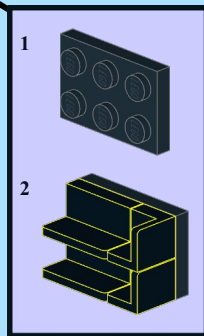
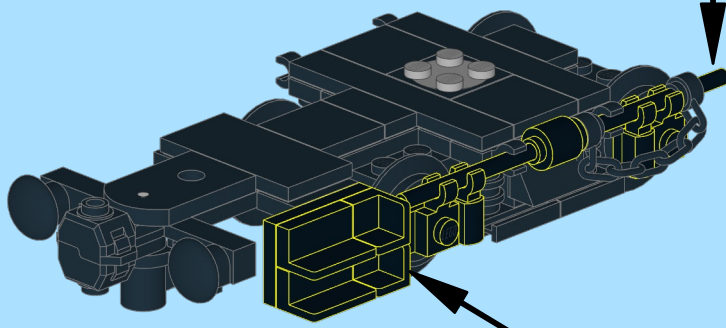
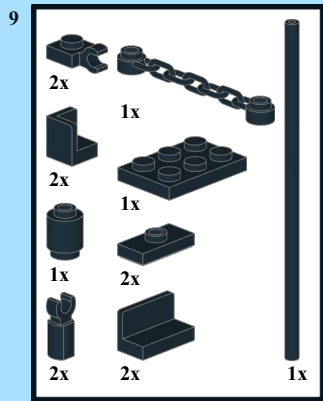
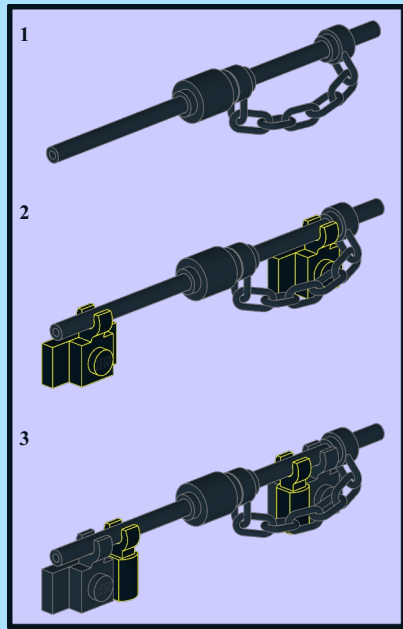

x2

