

PwPost4ue28 Post and Baggagecar

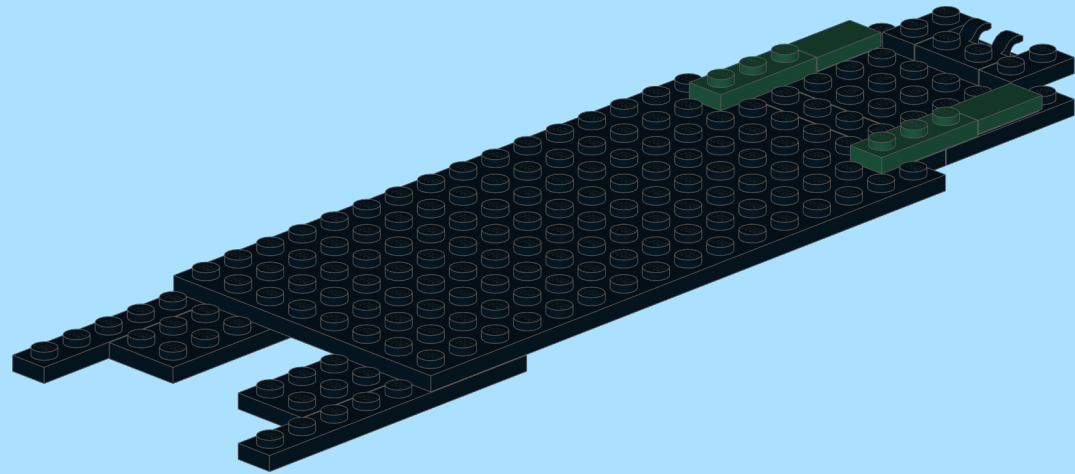

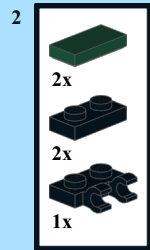

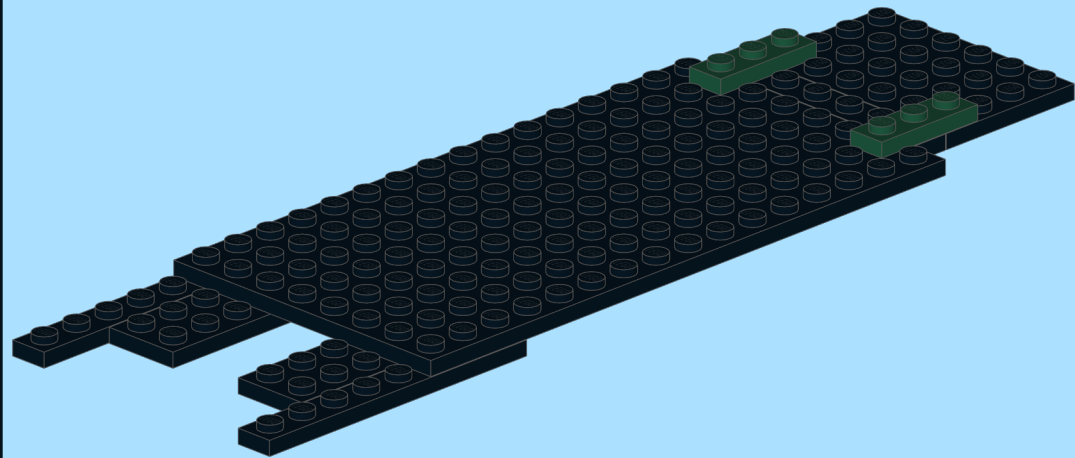

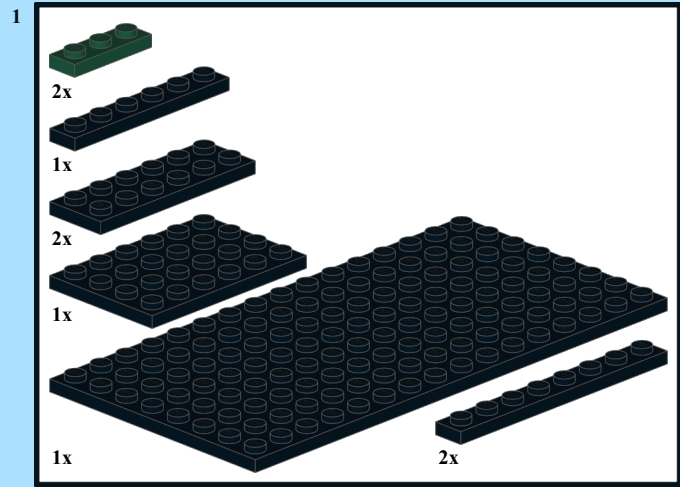

Design by Filip Pienkowski

INSTRUCTION BY
KNUD ALBRECHTSEN
www.snakebyte.dk/lego



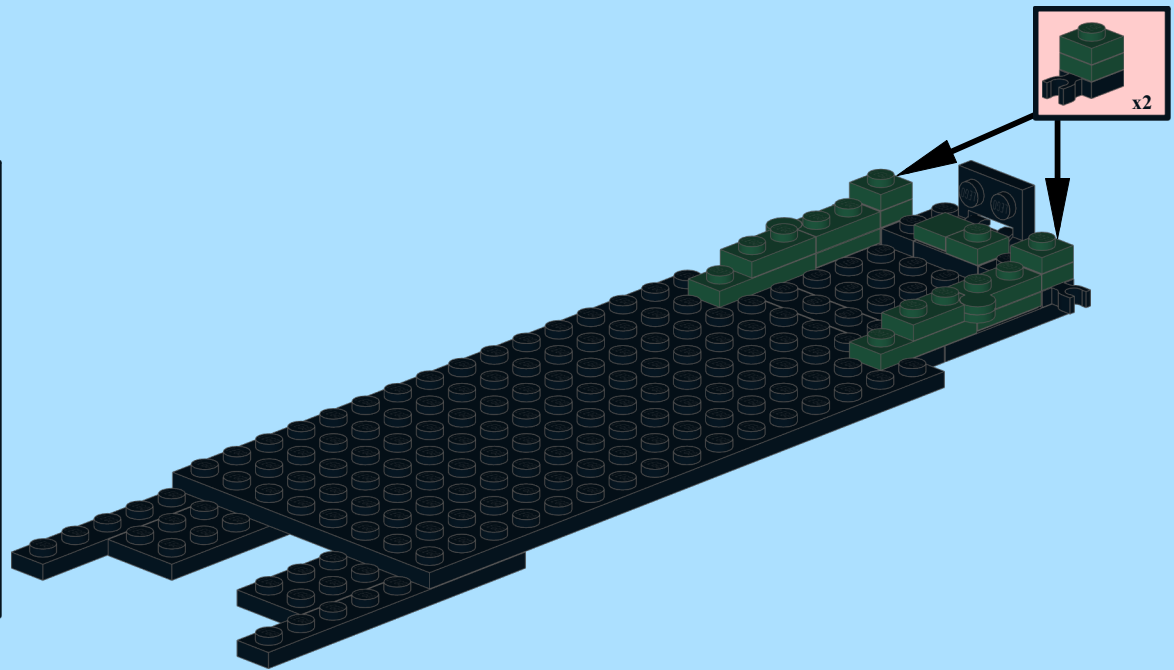

3

-  1x
-  5x
-  2x
-  2x
-  2x
-  1x



4

-  2x
-  2x
-  2x

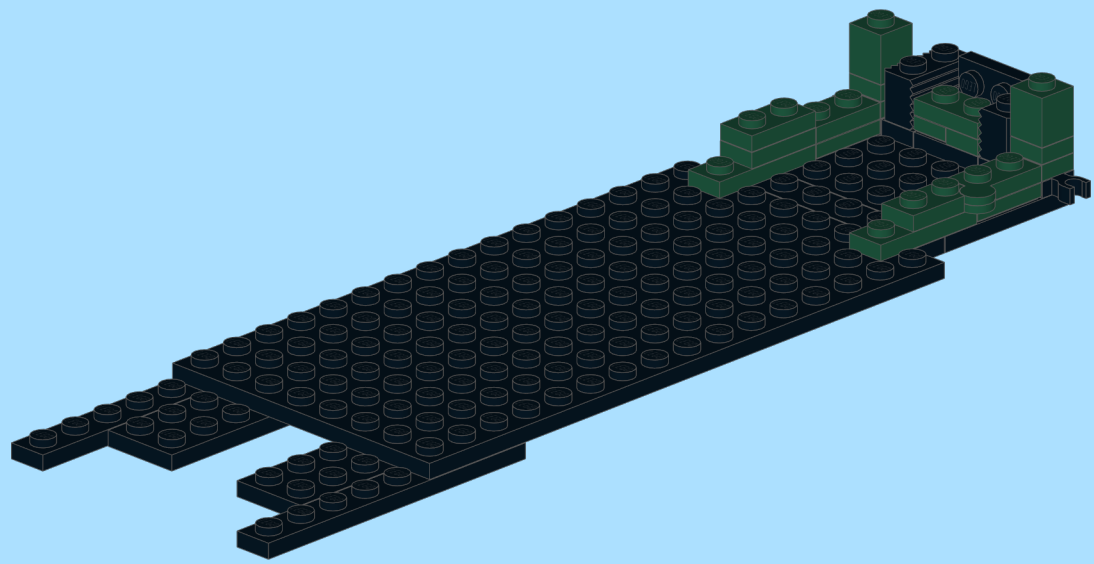

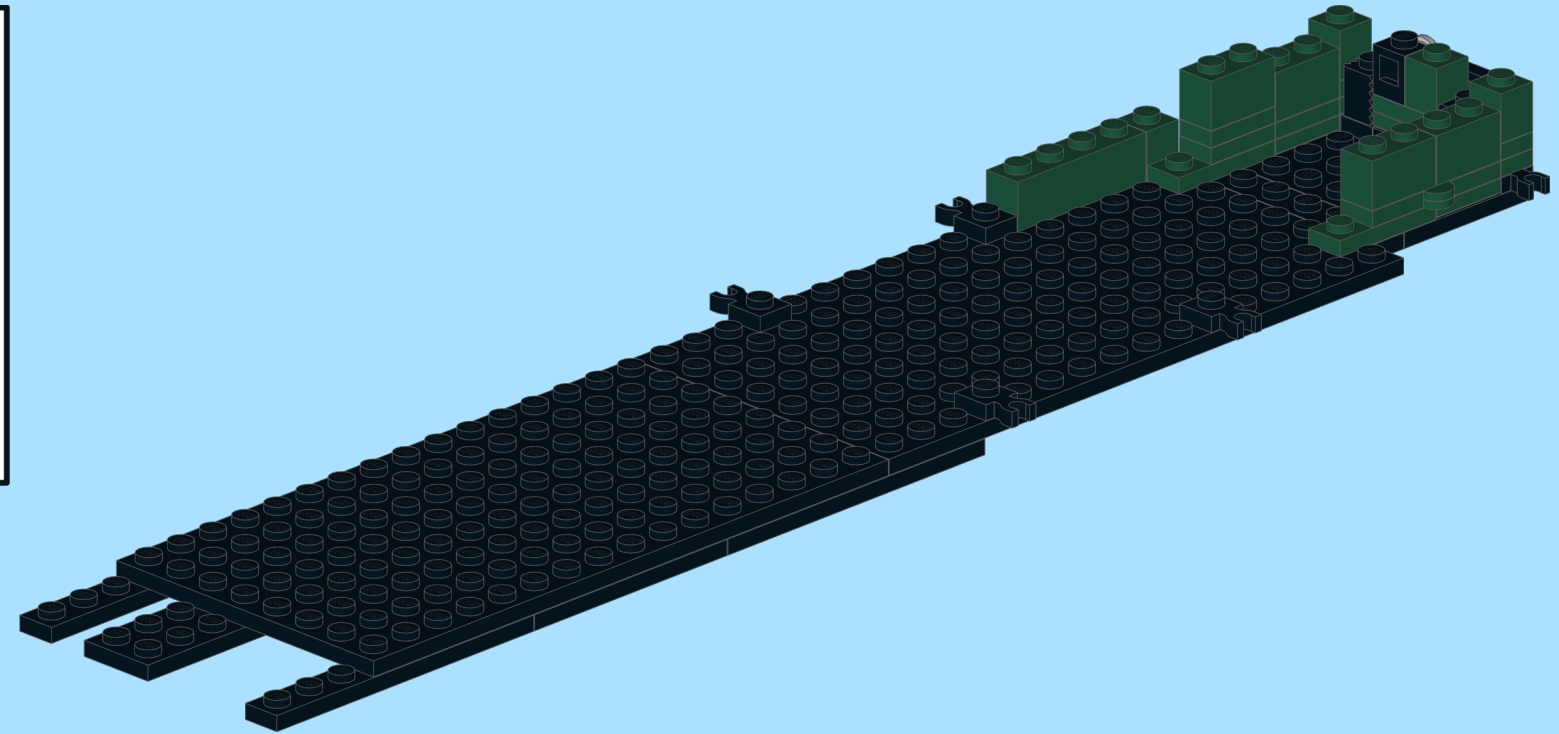
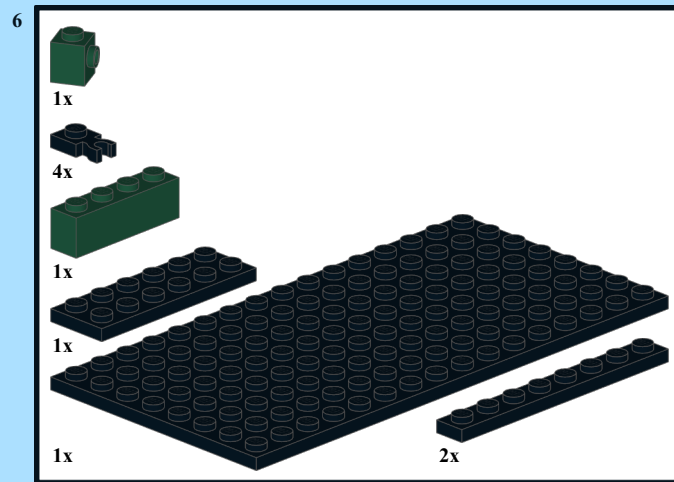
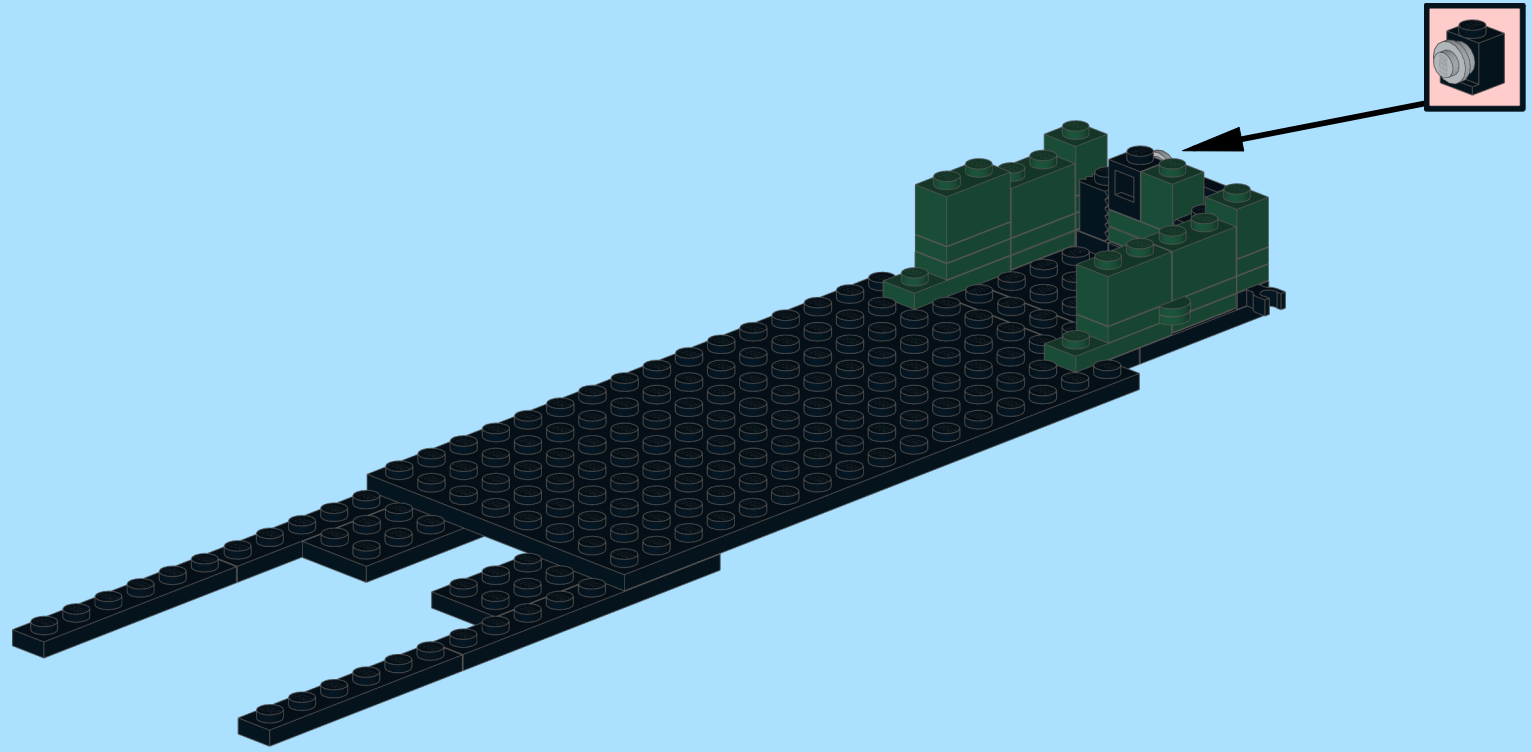
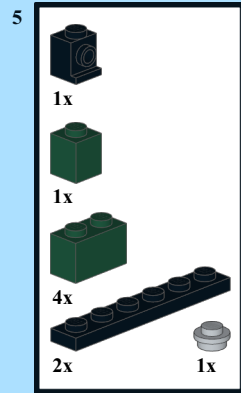

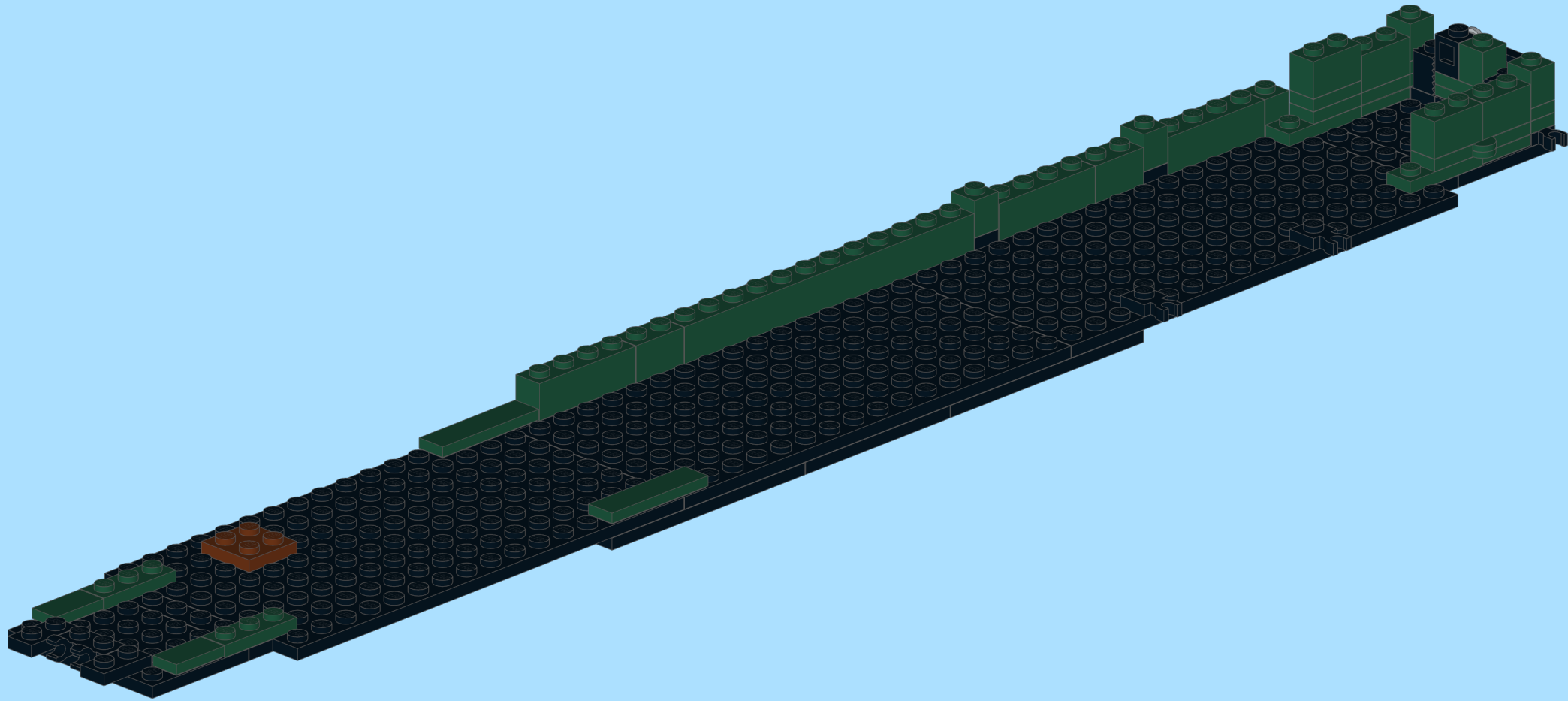
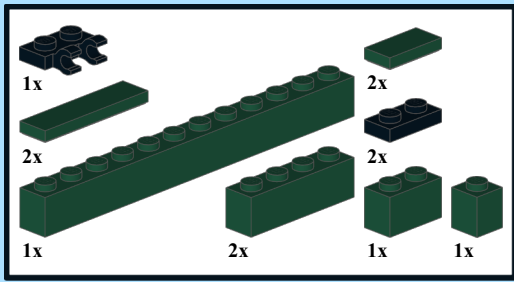

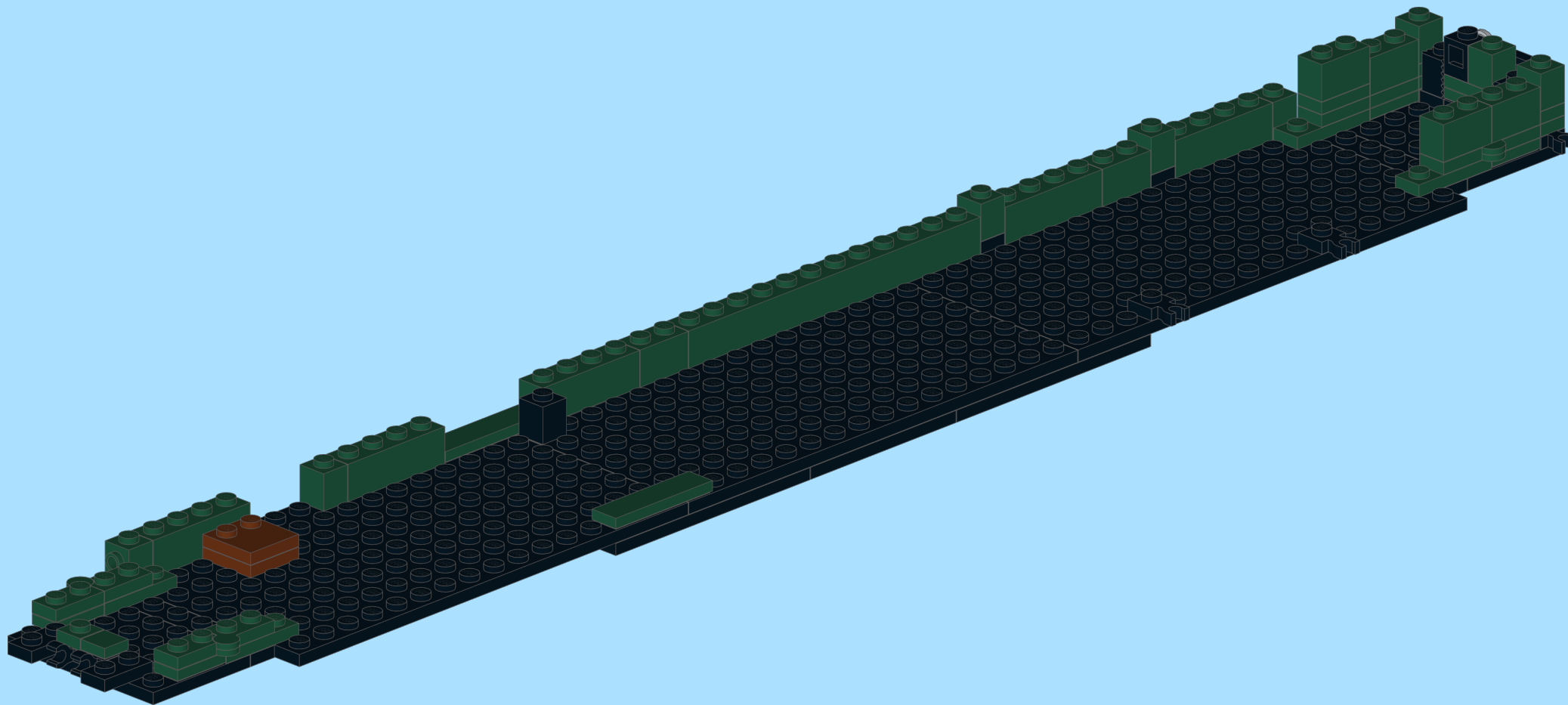
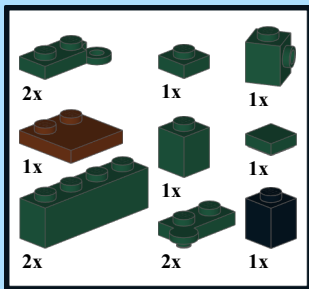

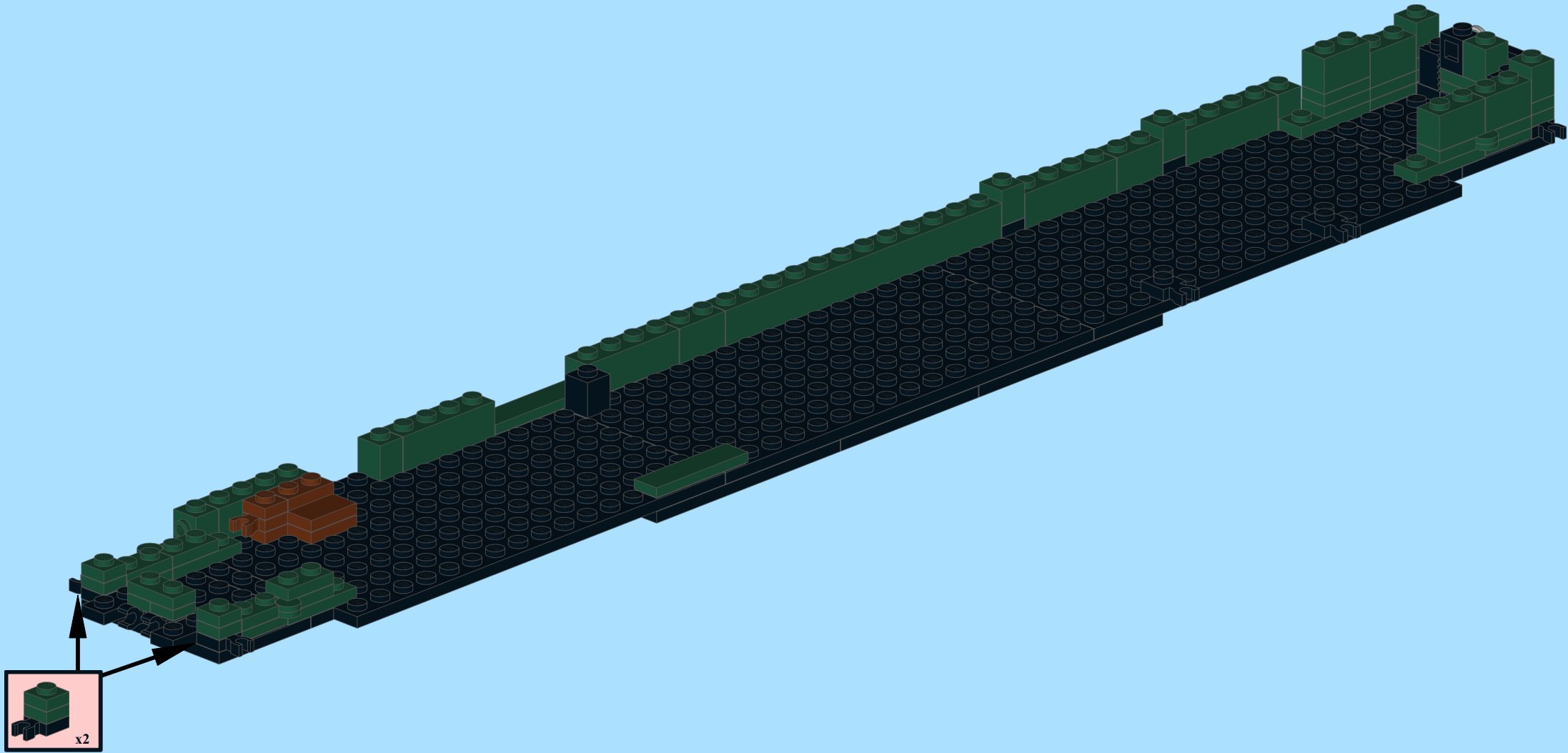
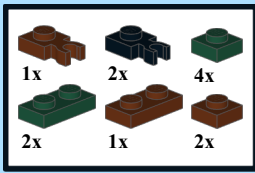









-  2x
-  1x
-  1x
-  2x
-  1x
-  1x
-  1x
-  1x

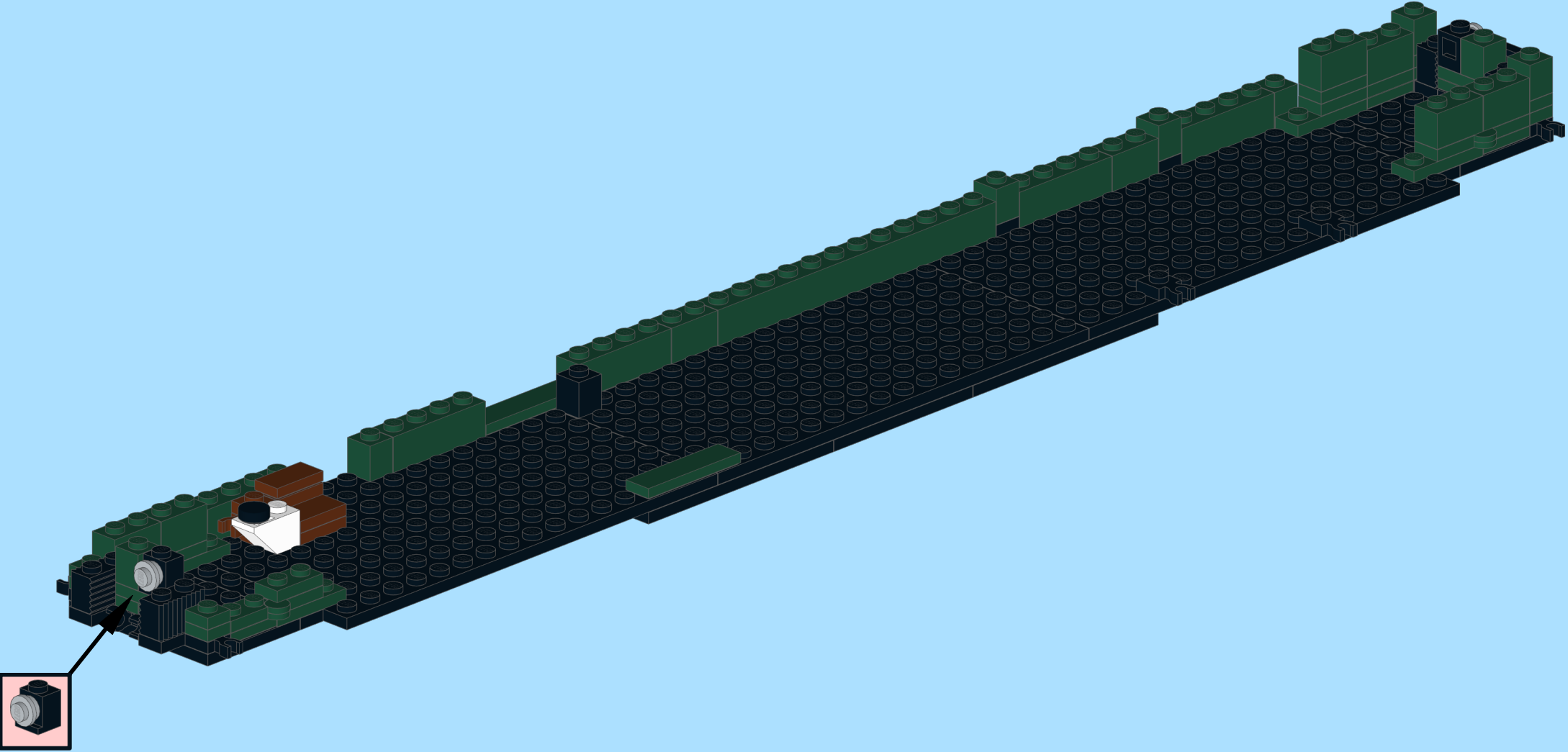

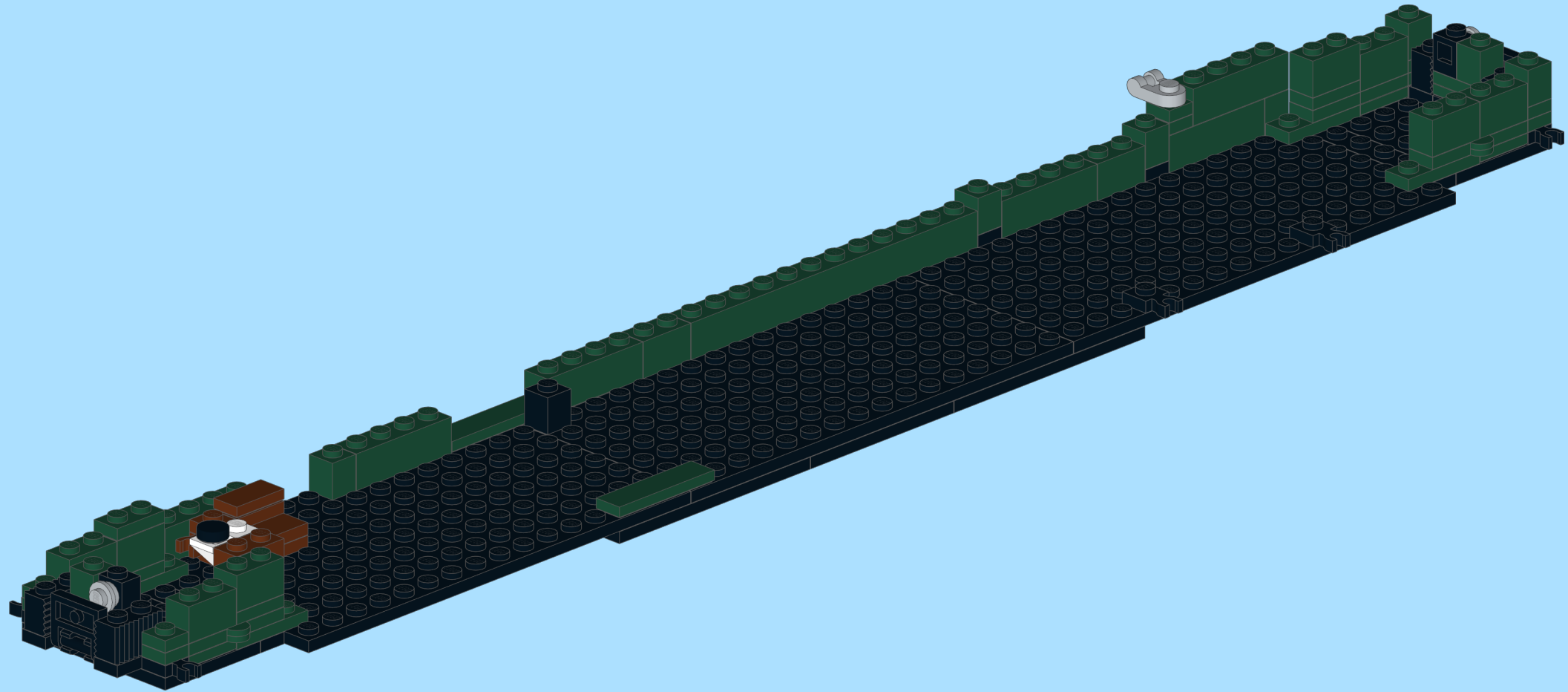
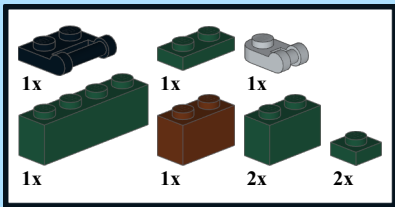

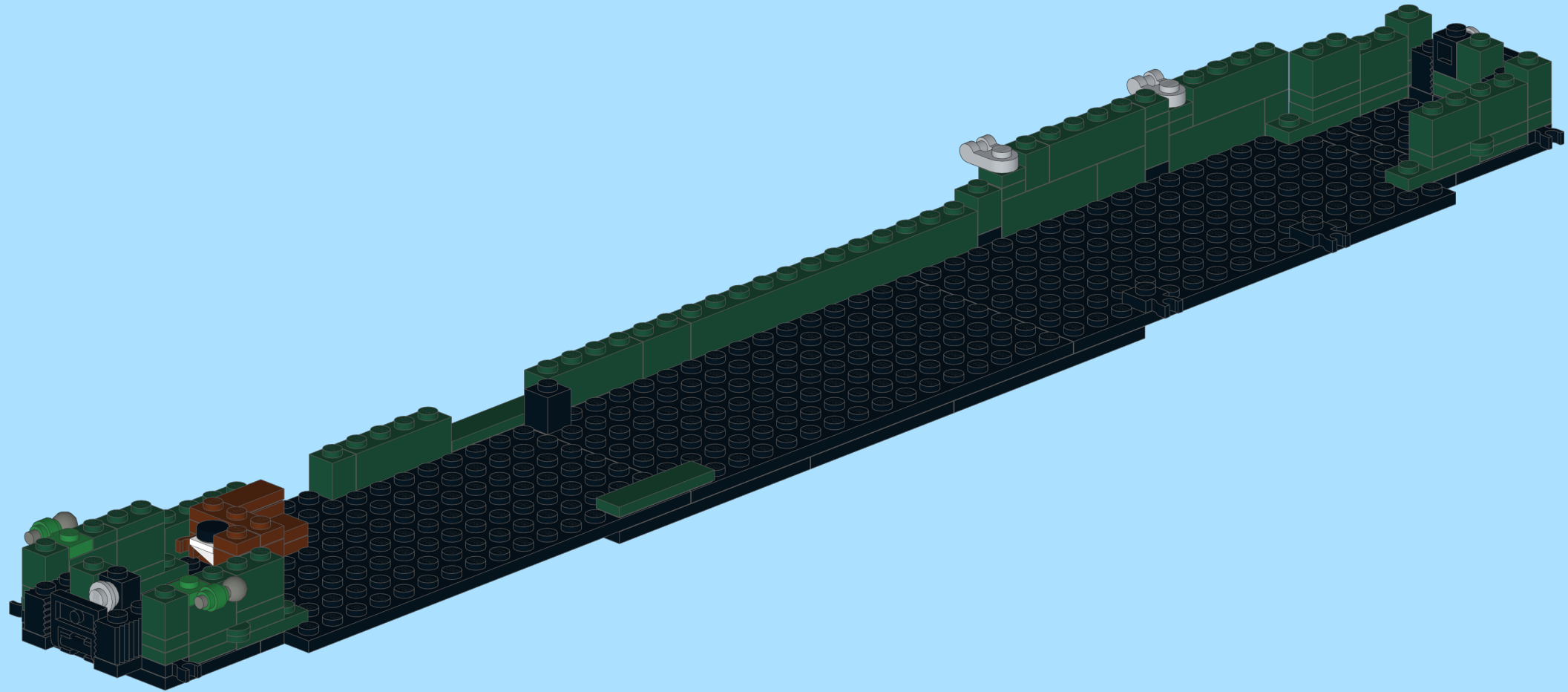
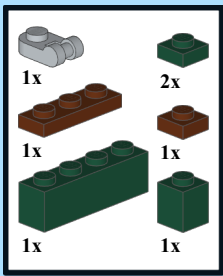

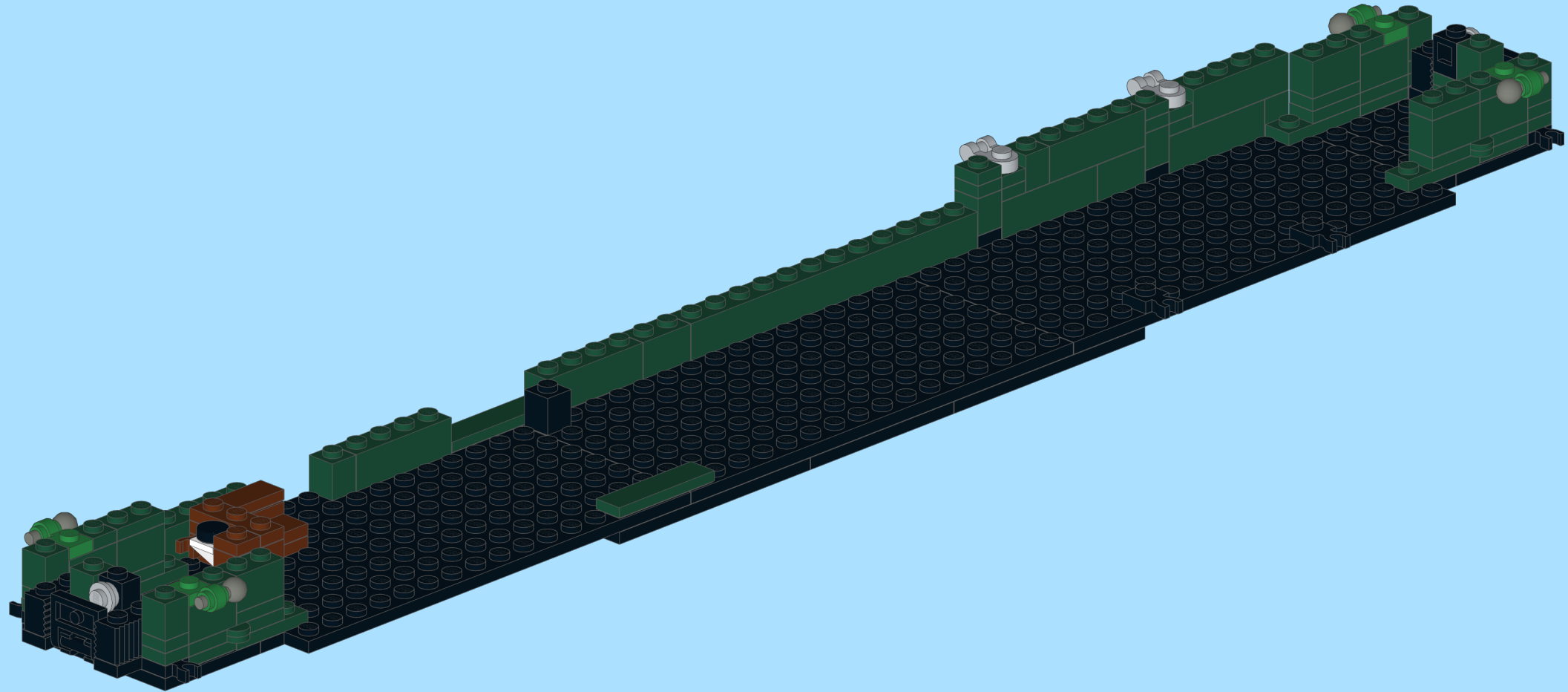
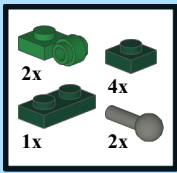

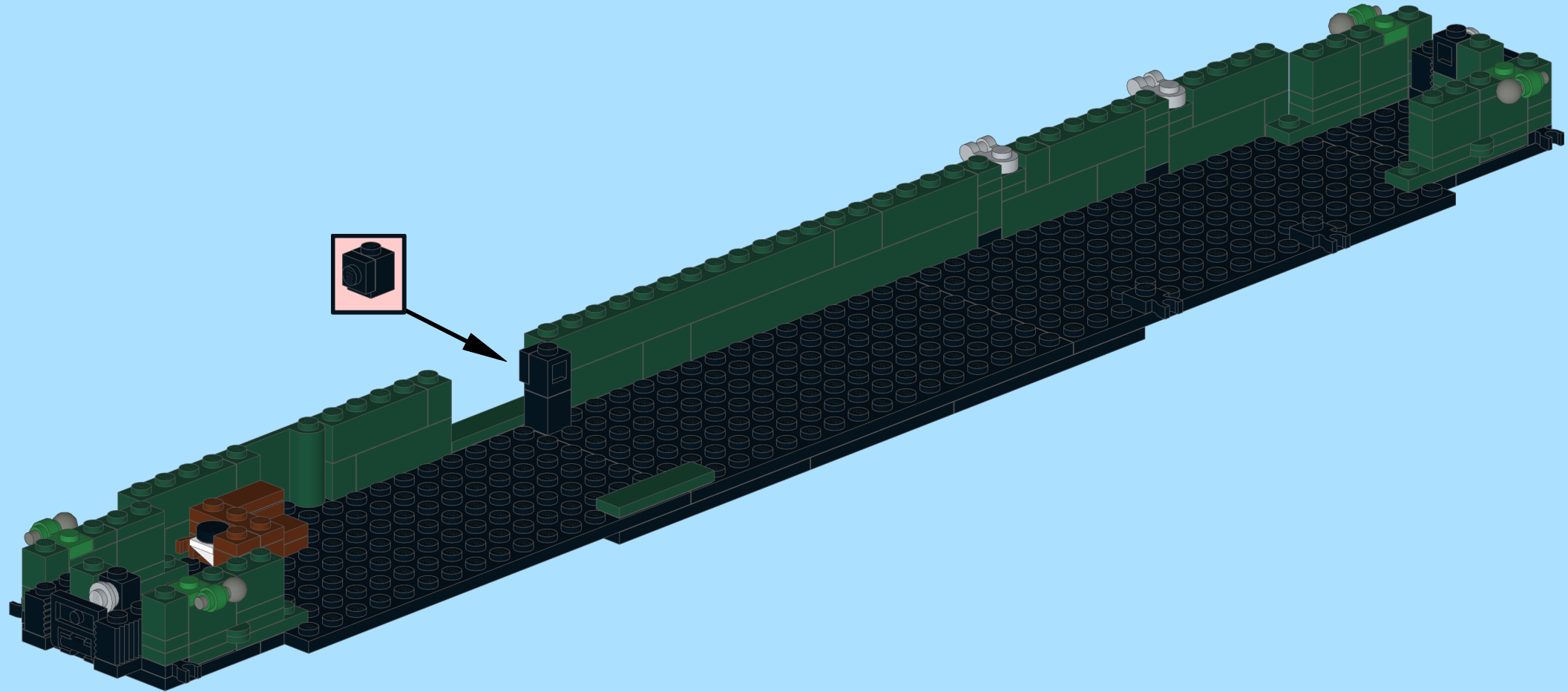
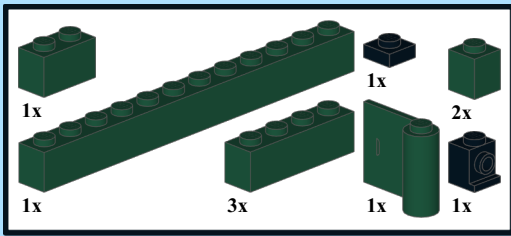

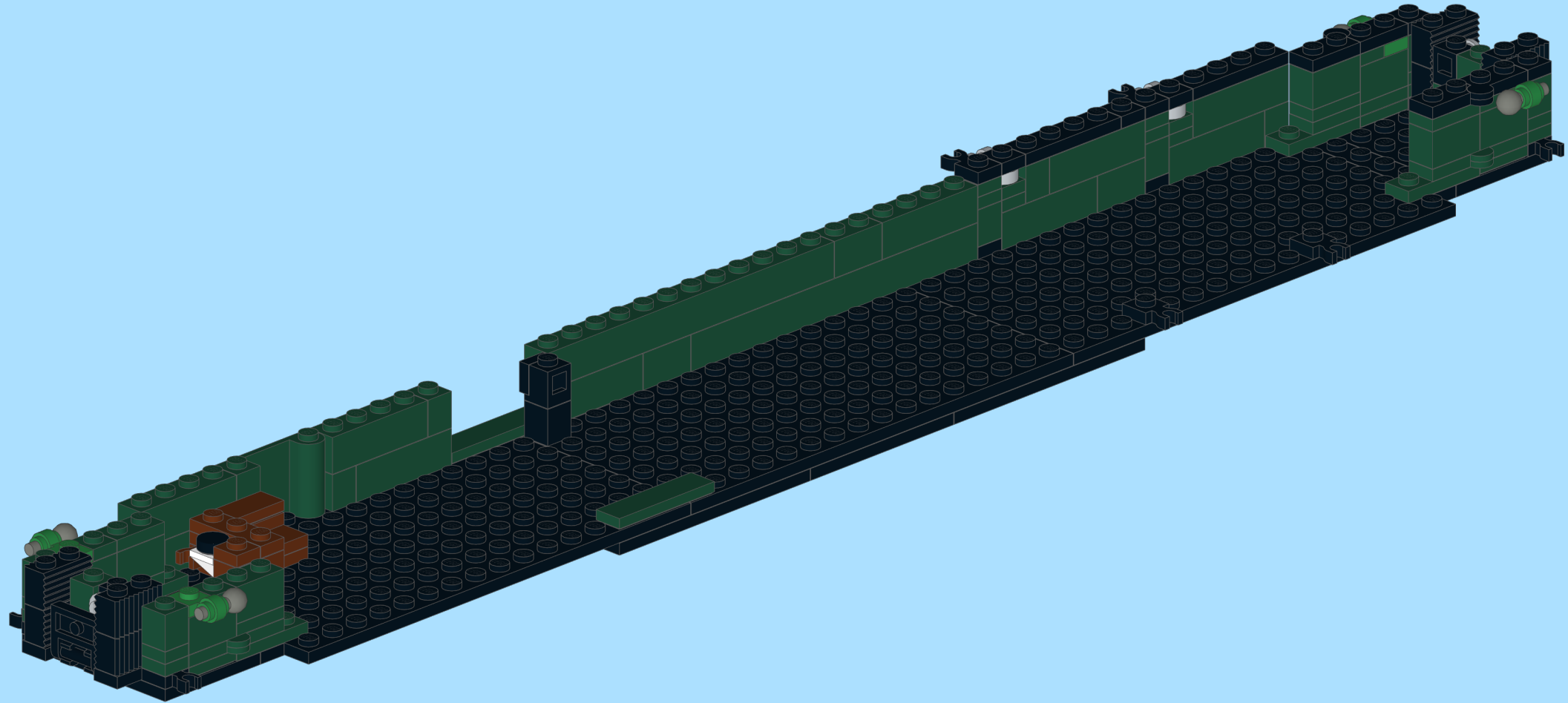
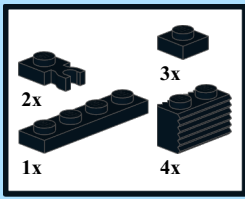

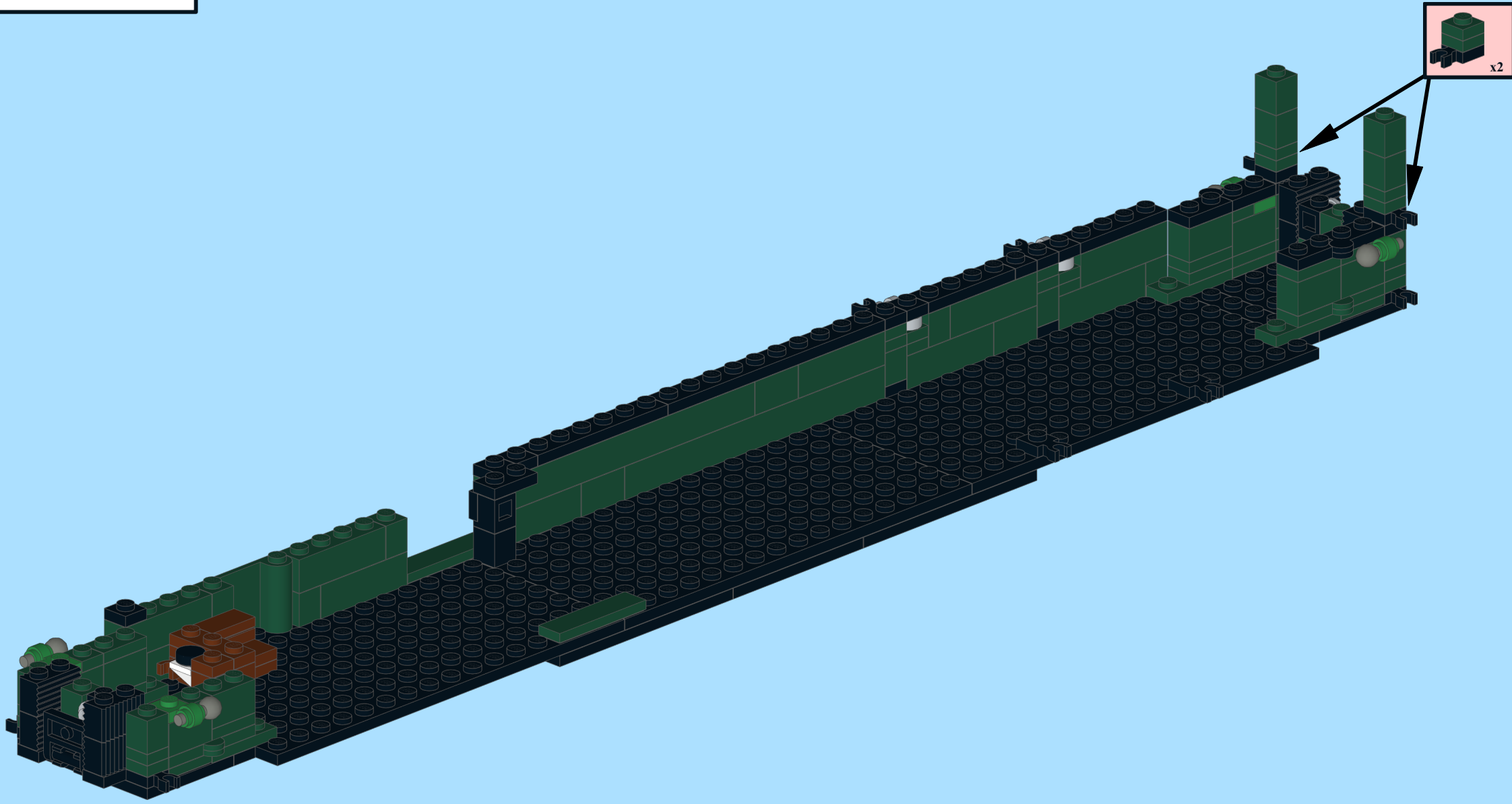
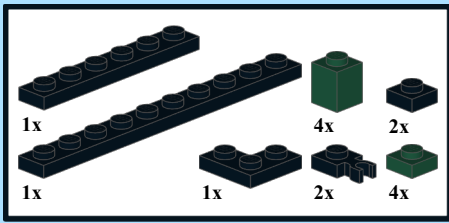

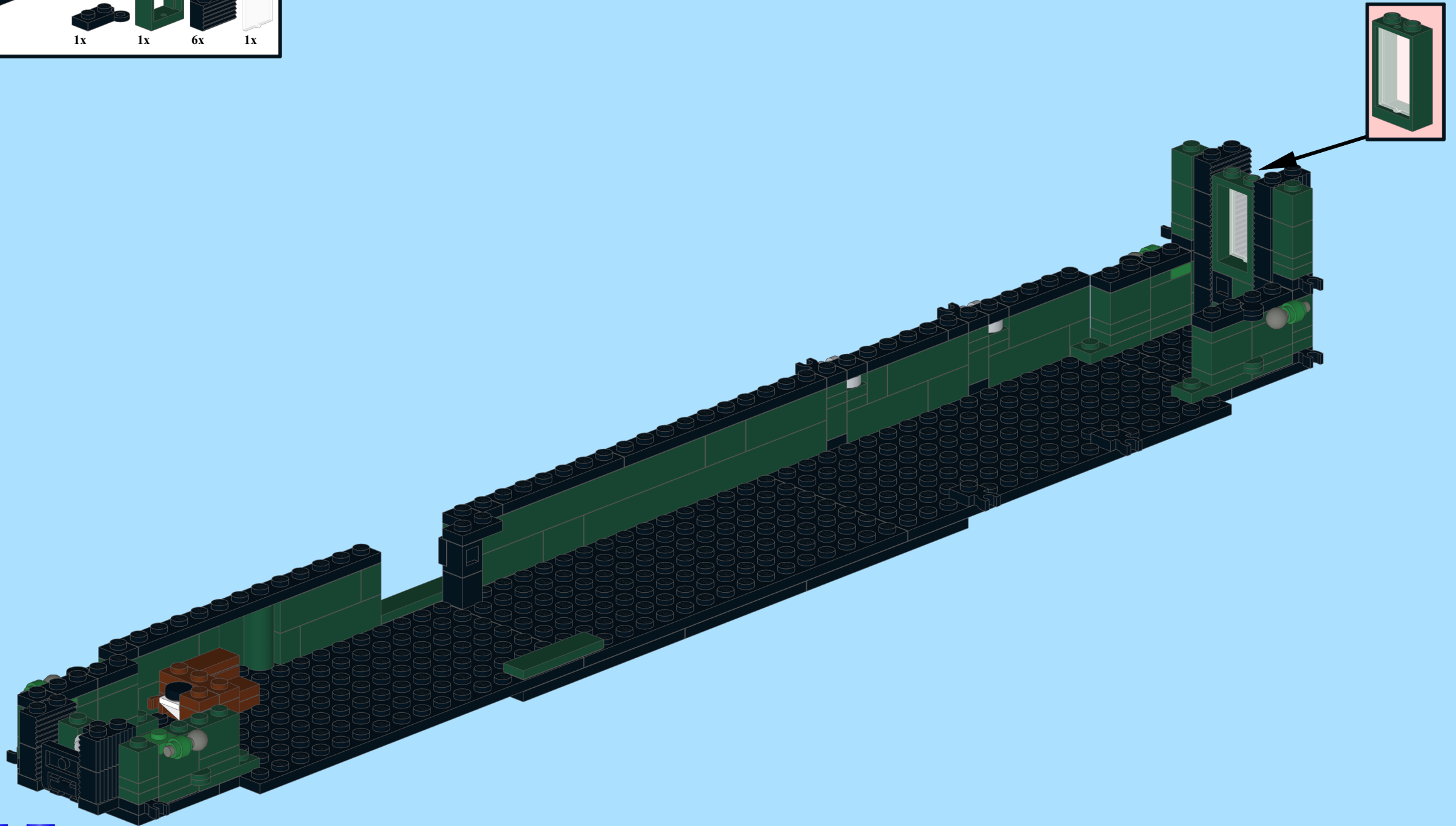
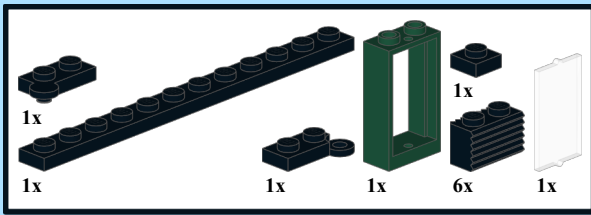

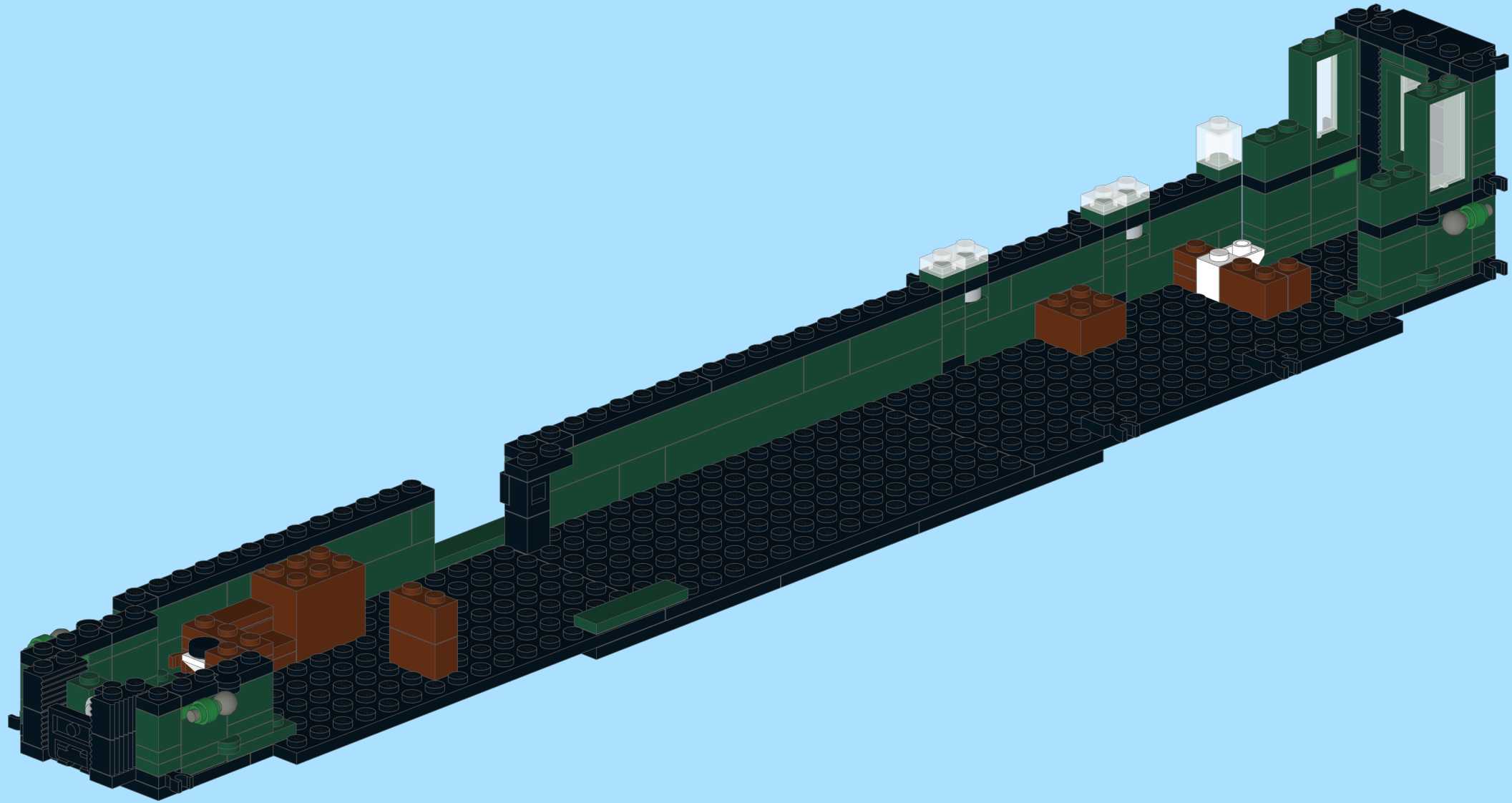
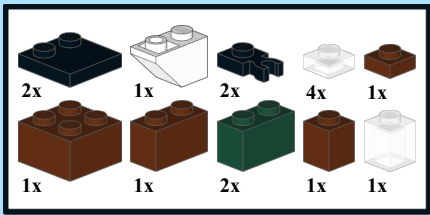

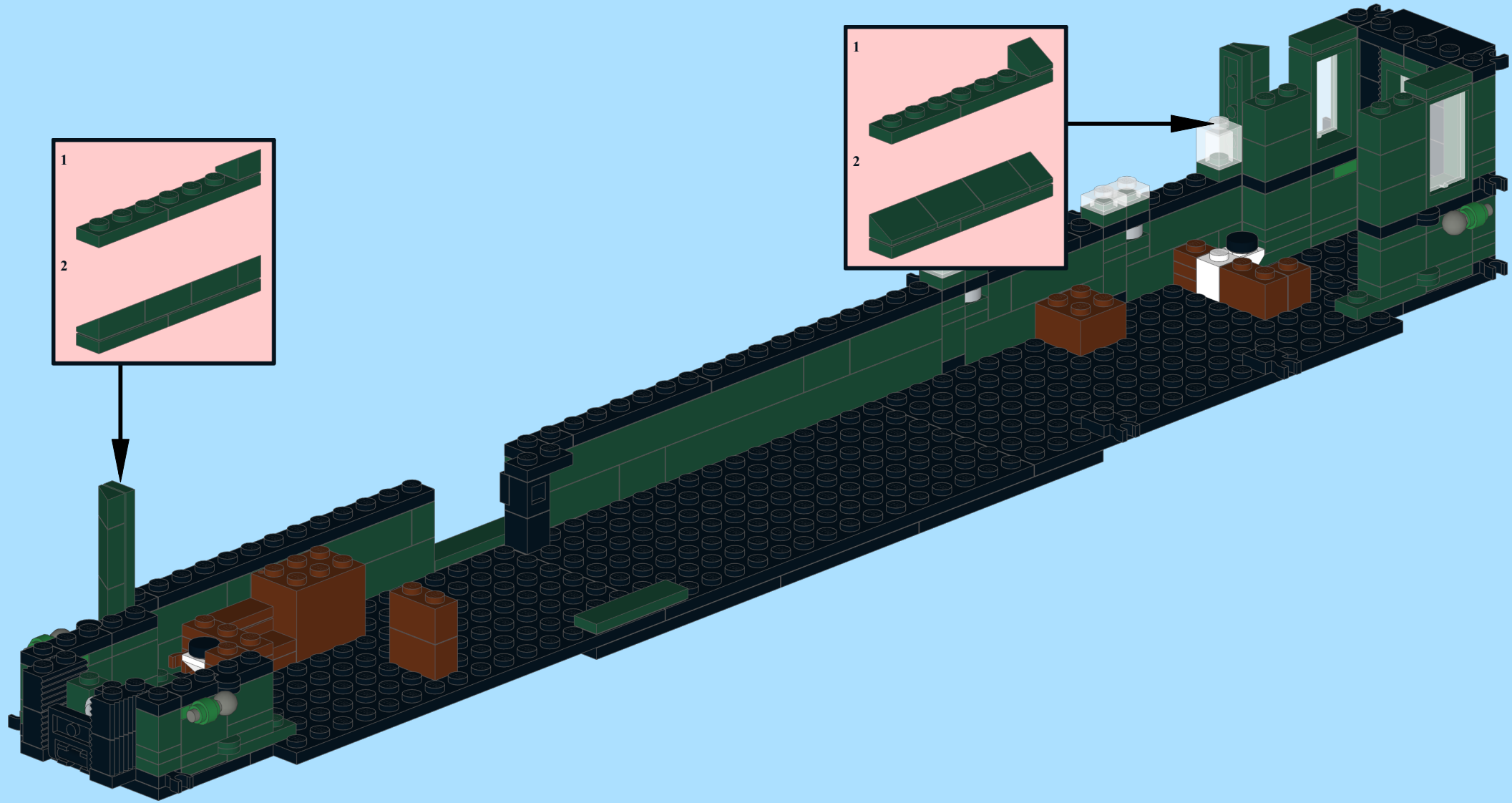
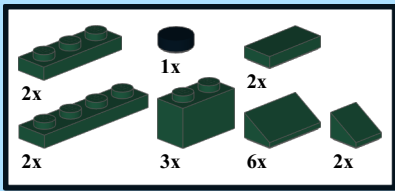

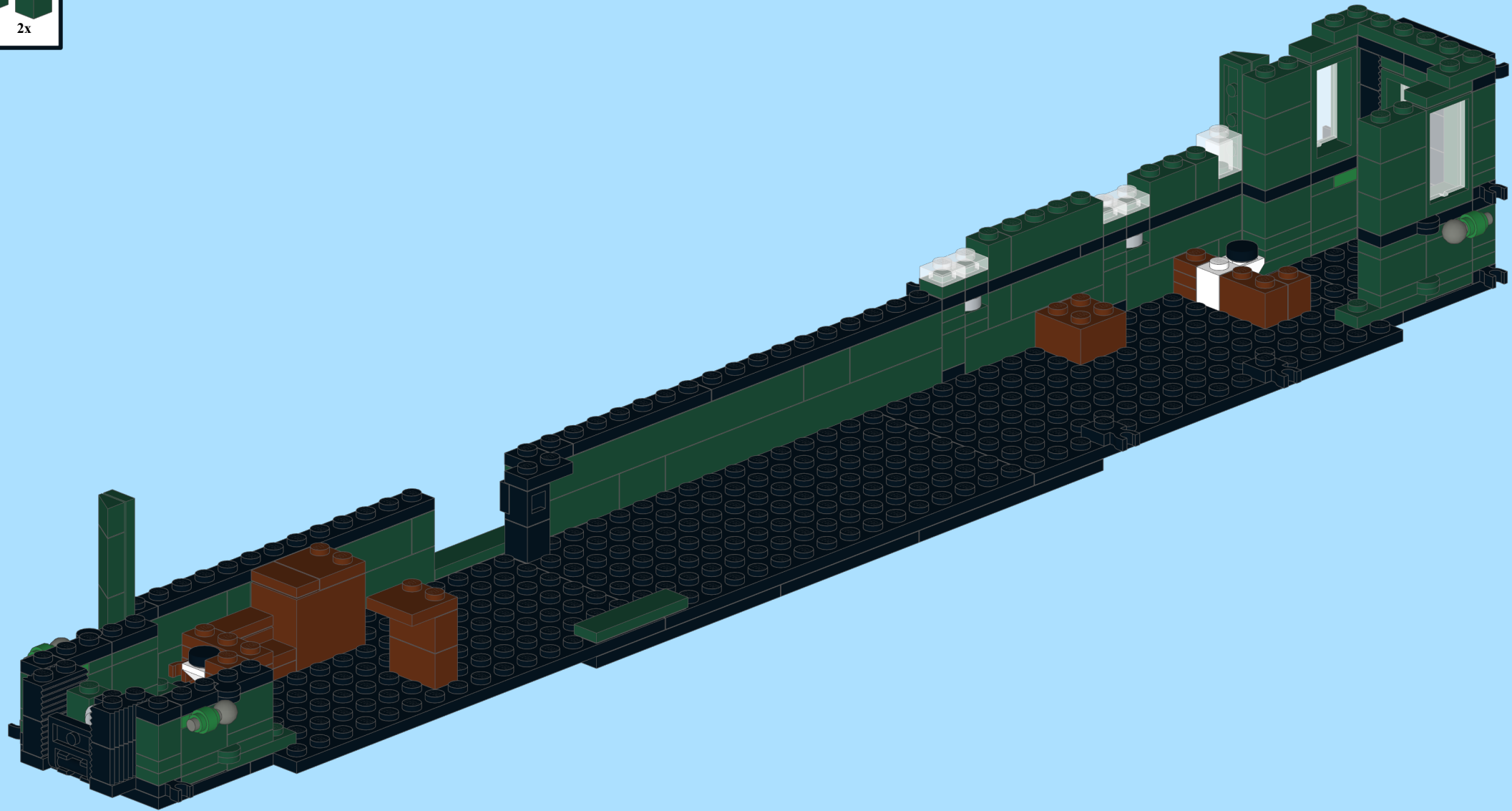
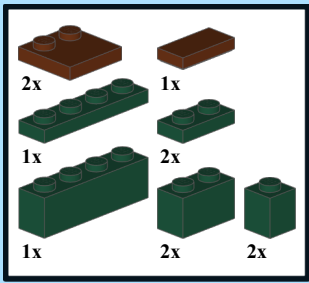

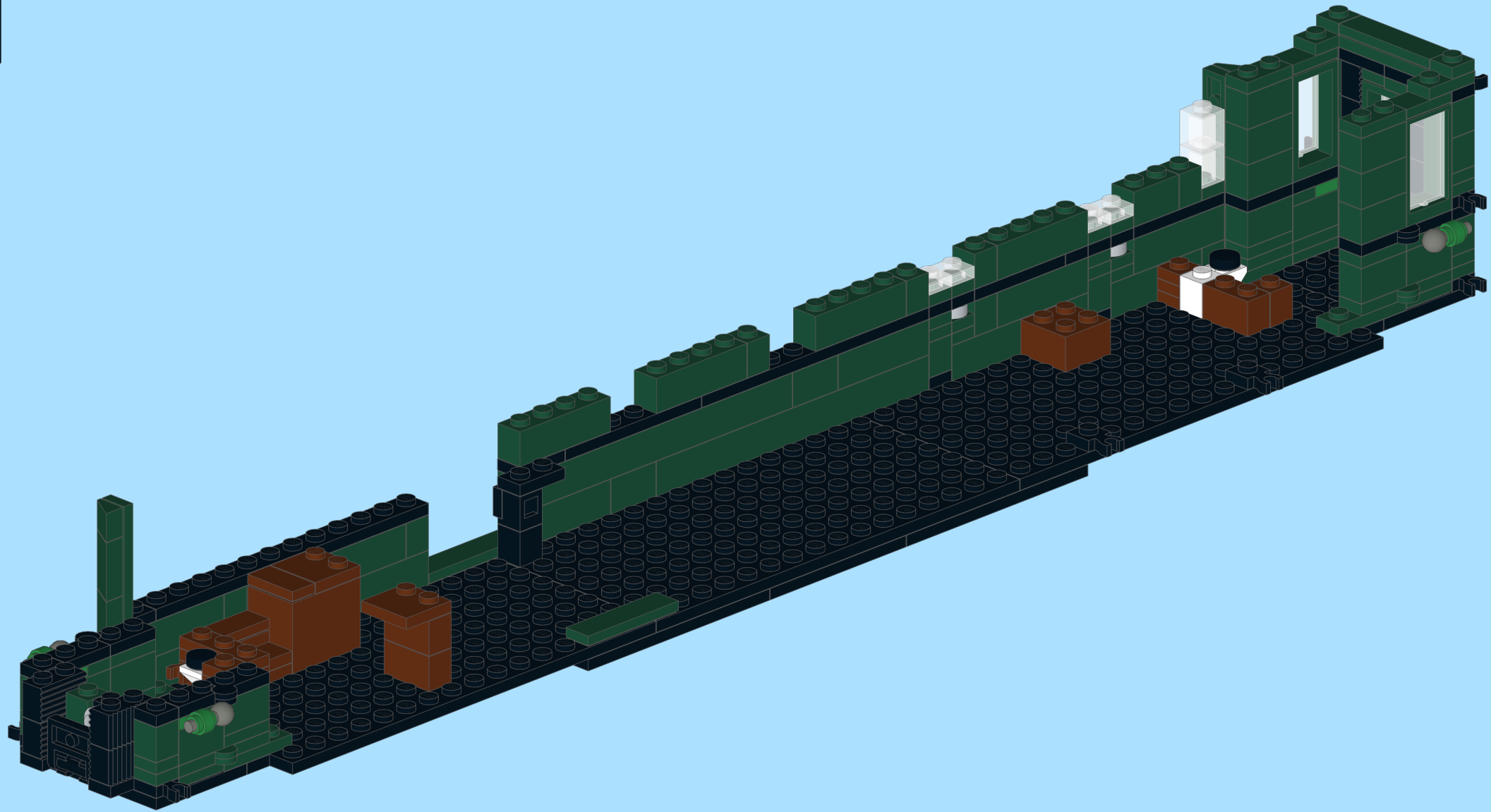
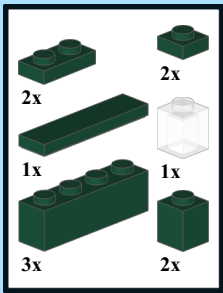

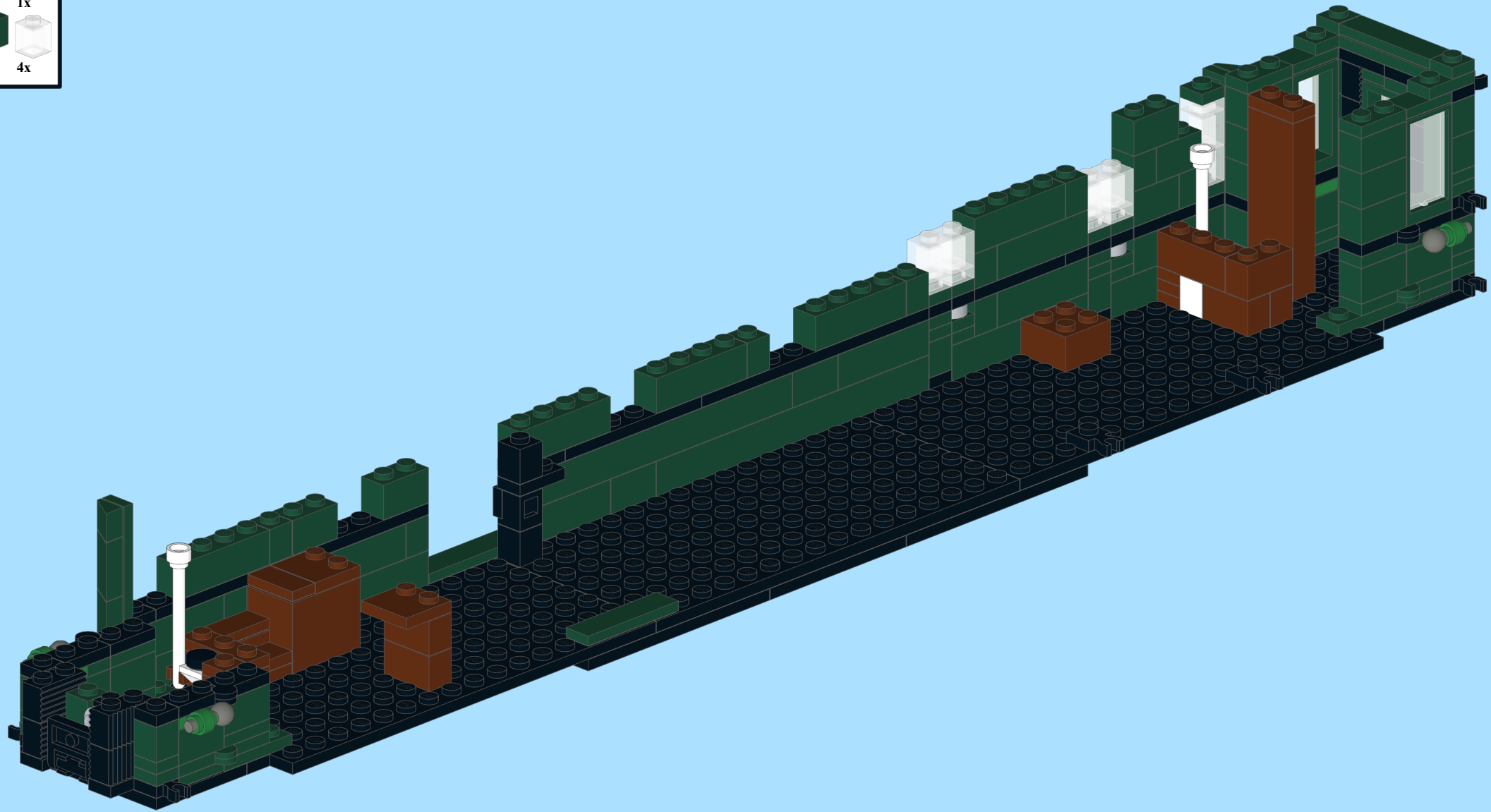
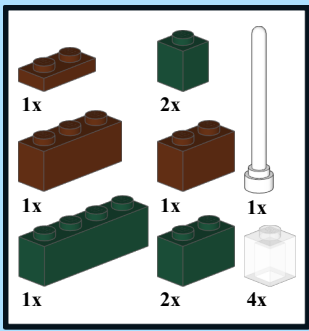

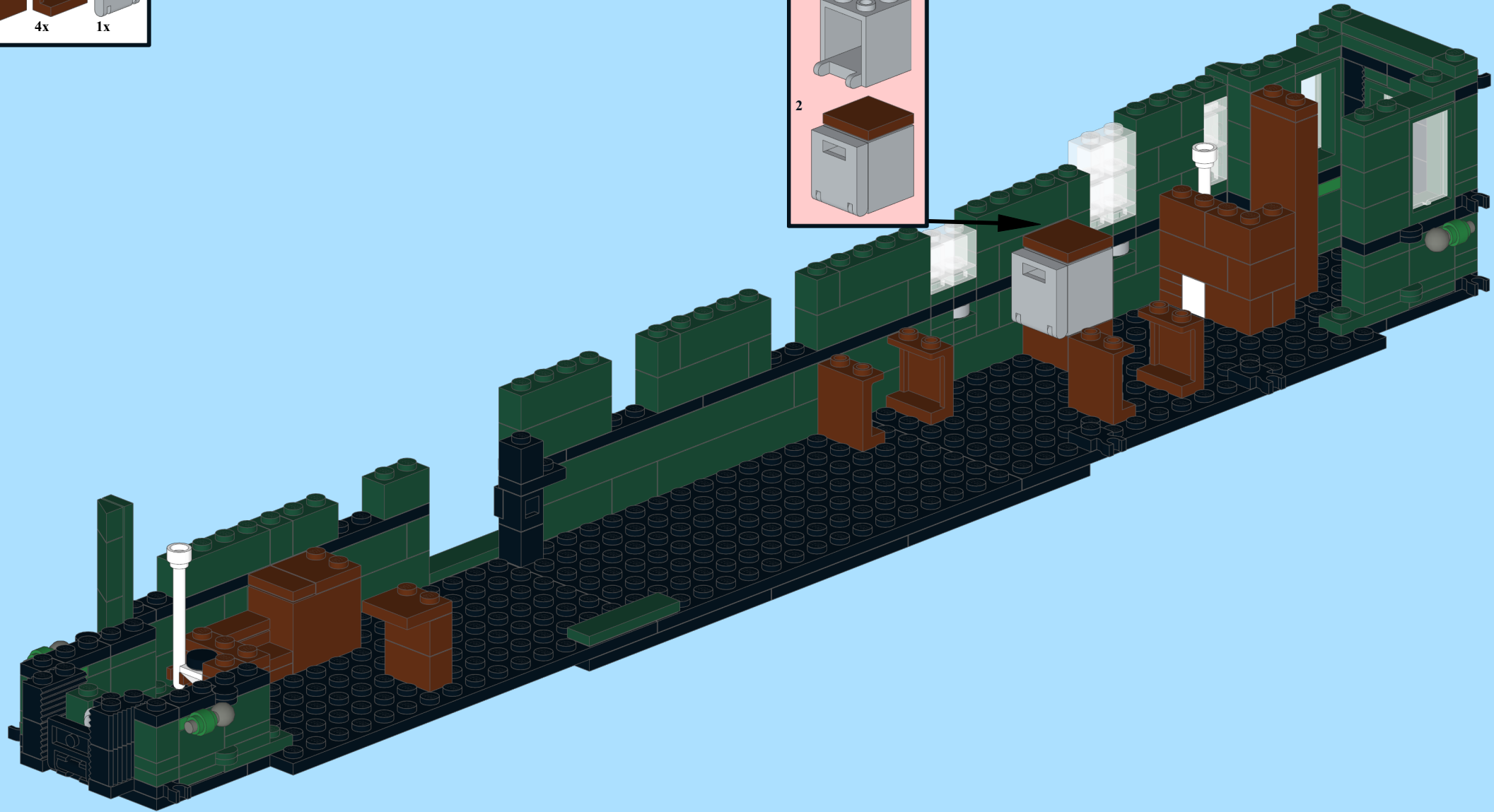
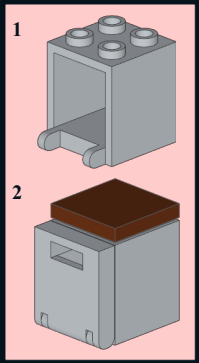
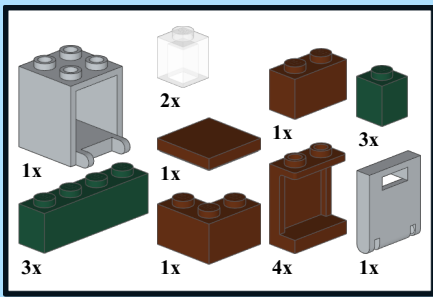

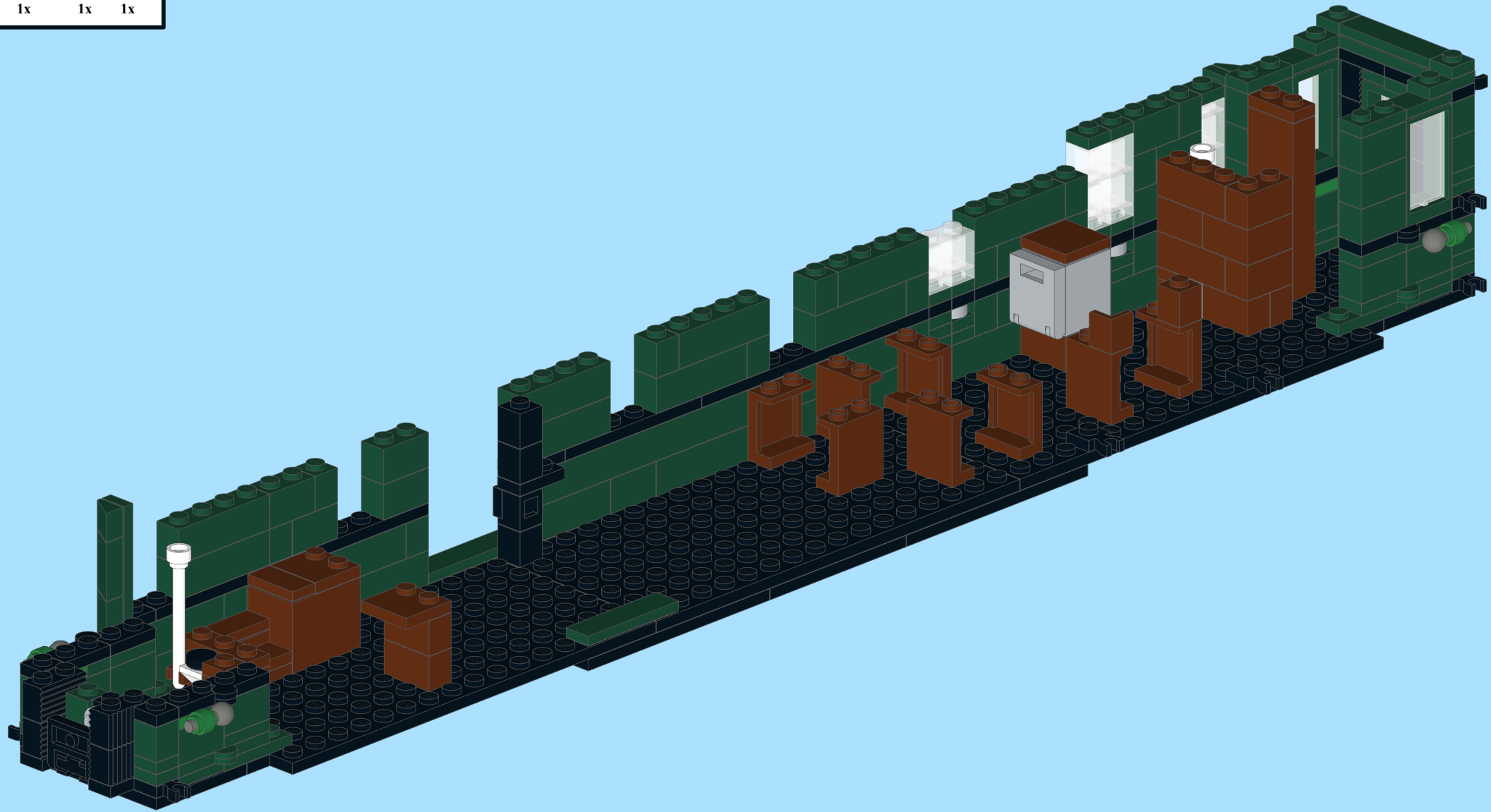
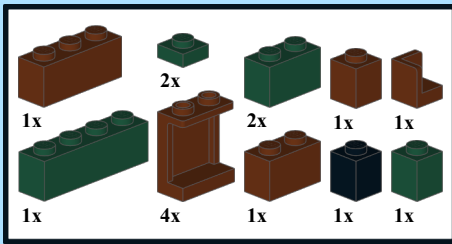

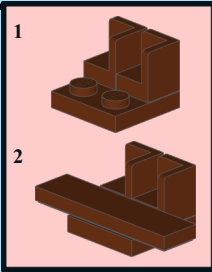
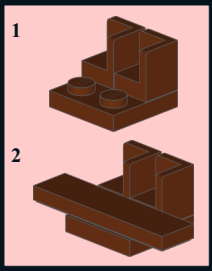
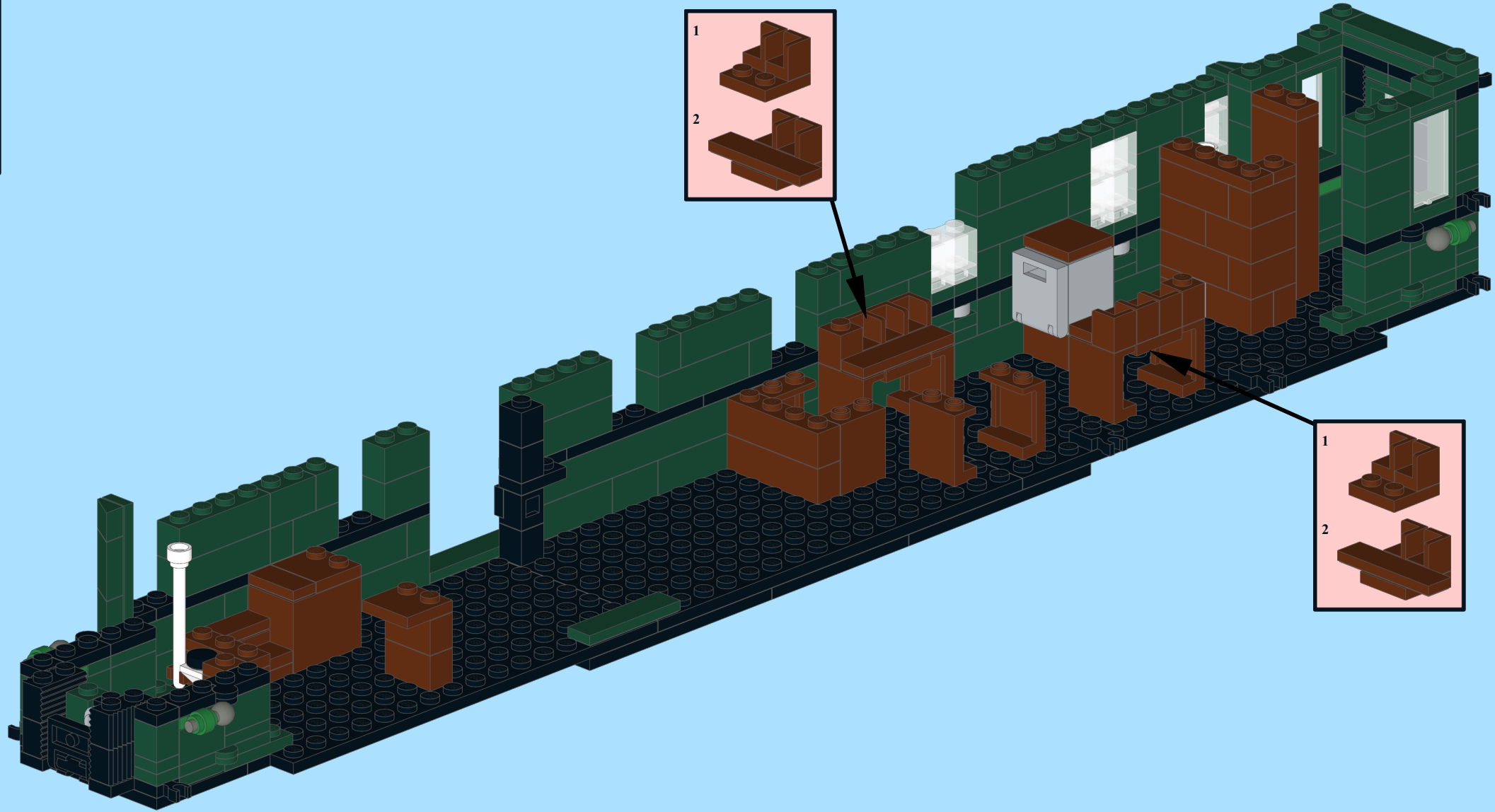
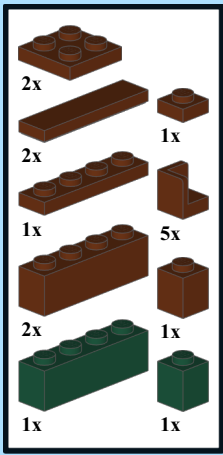

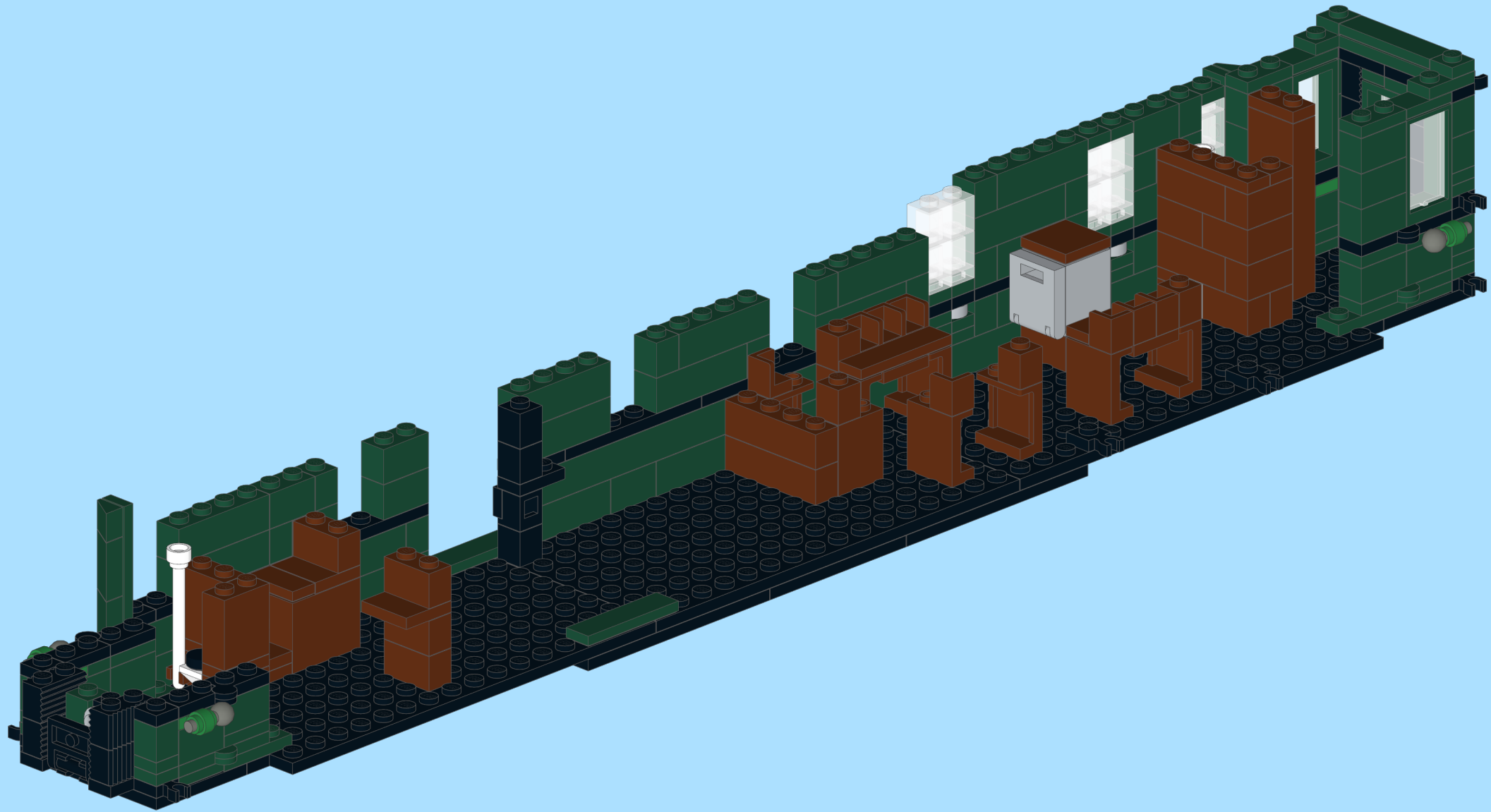
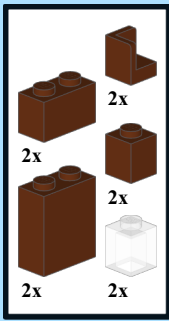

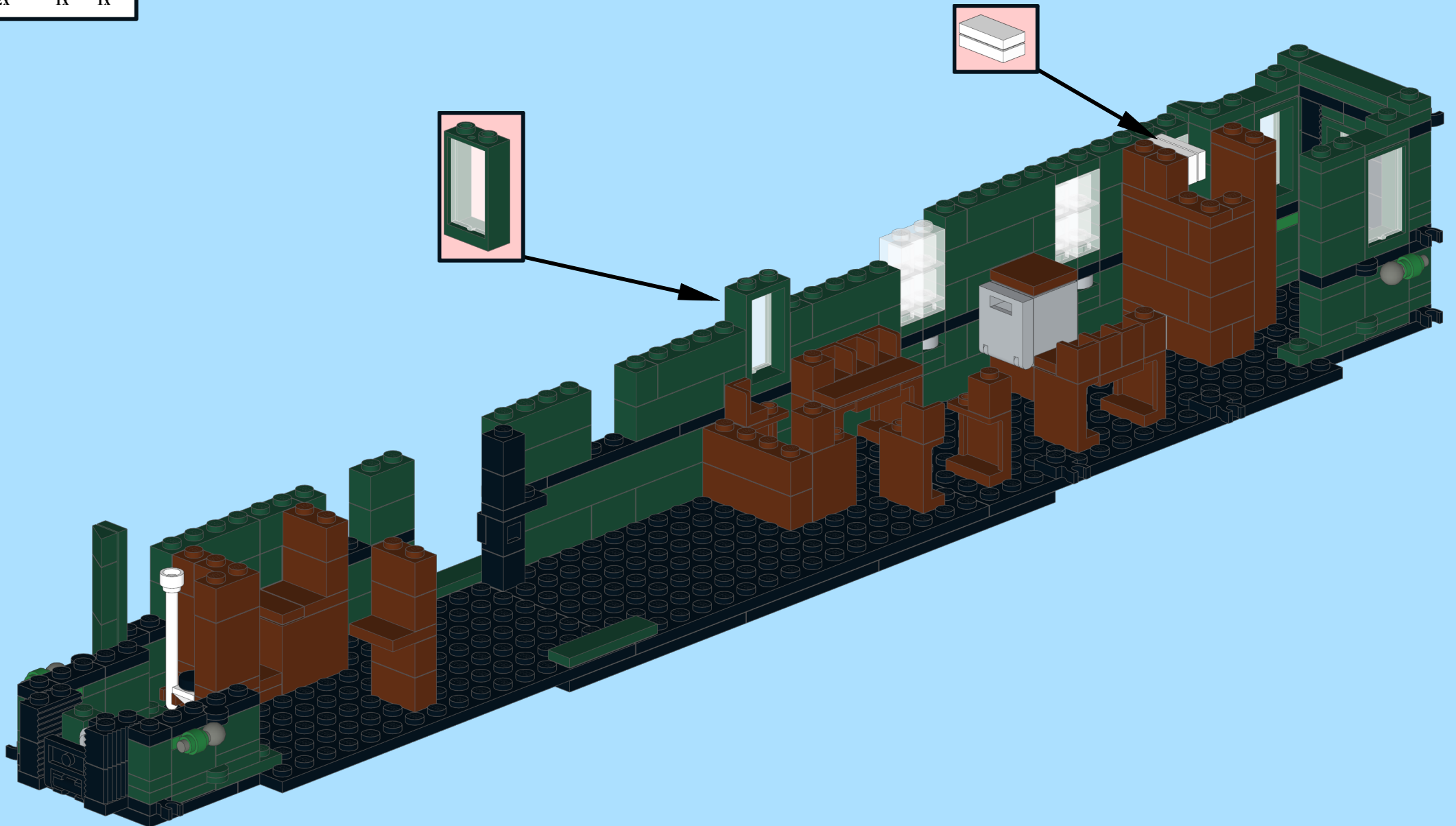
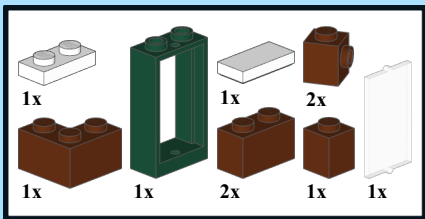

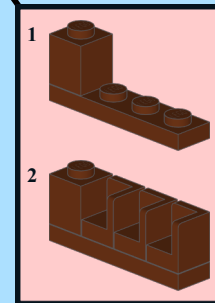
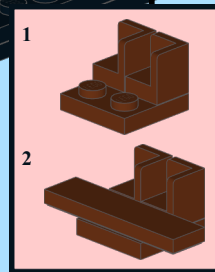
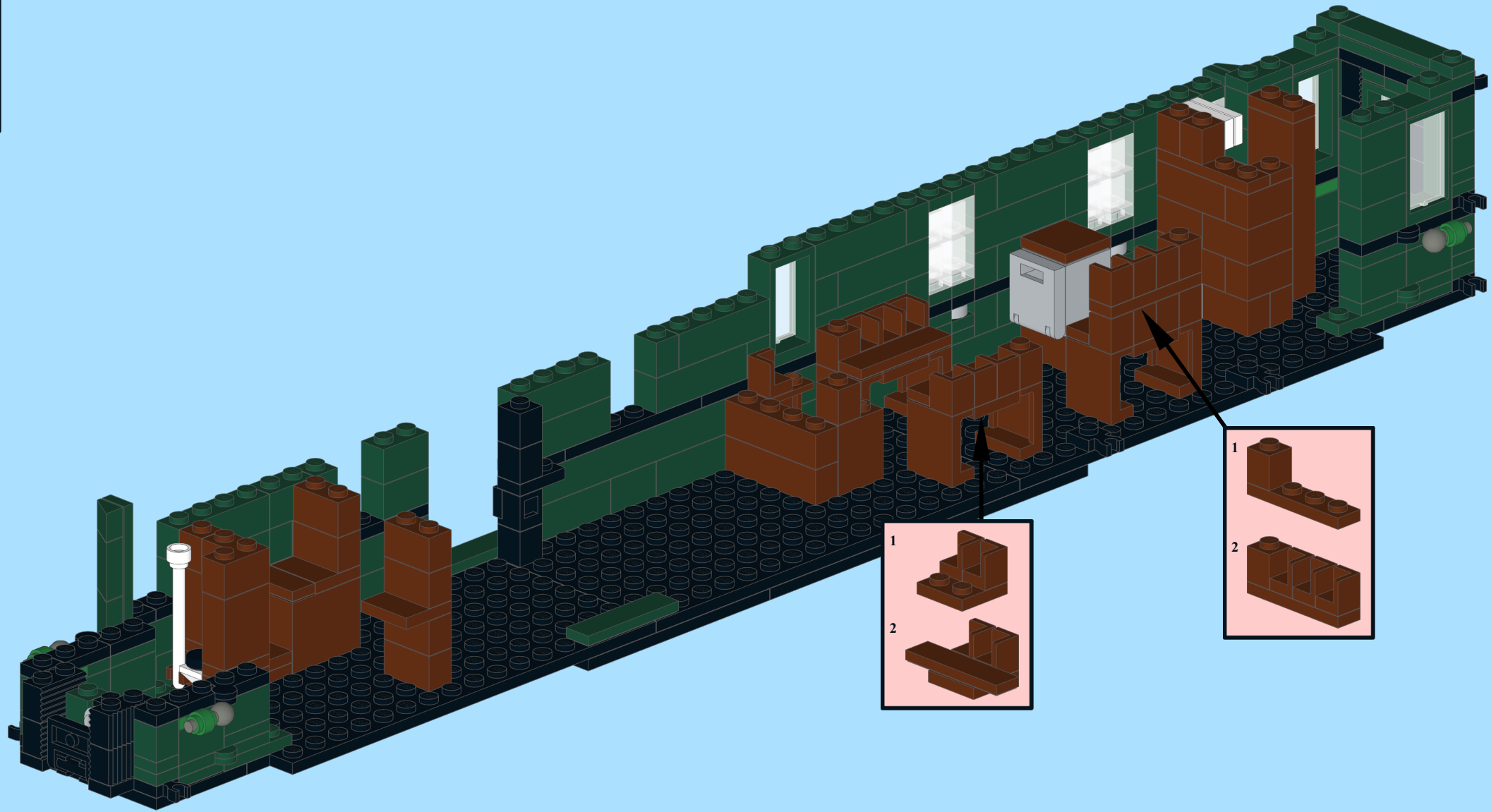
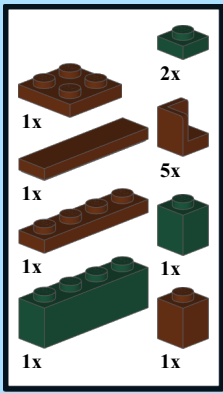

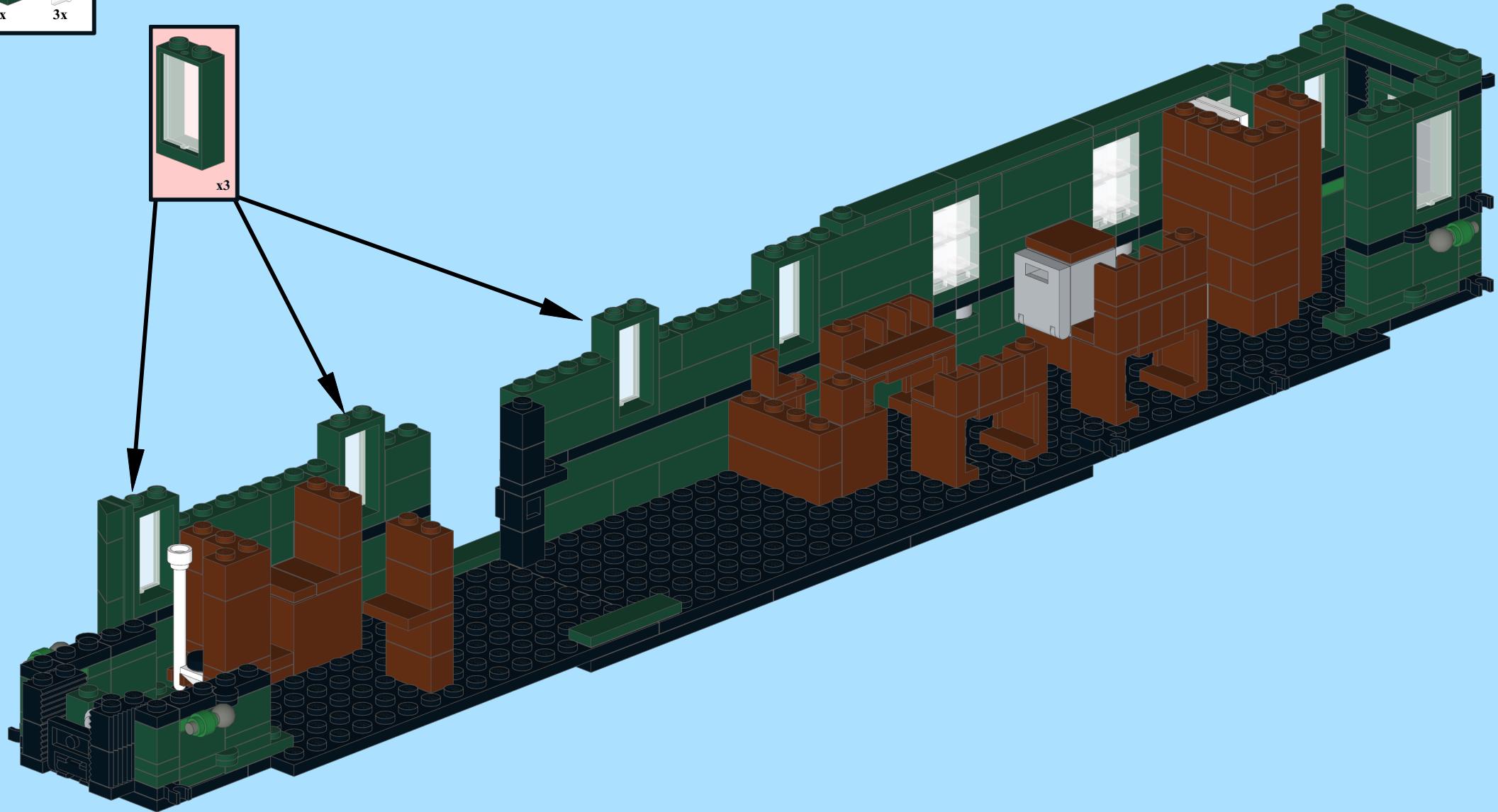
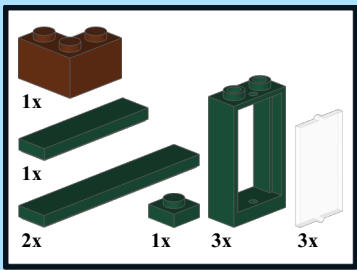

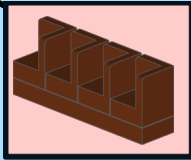
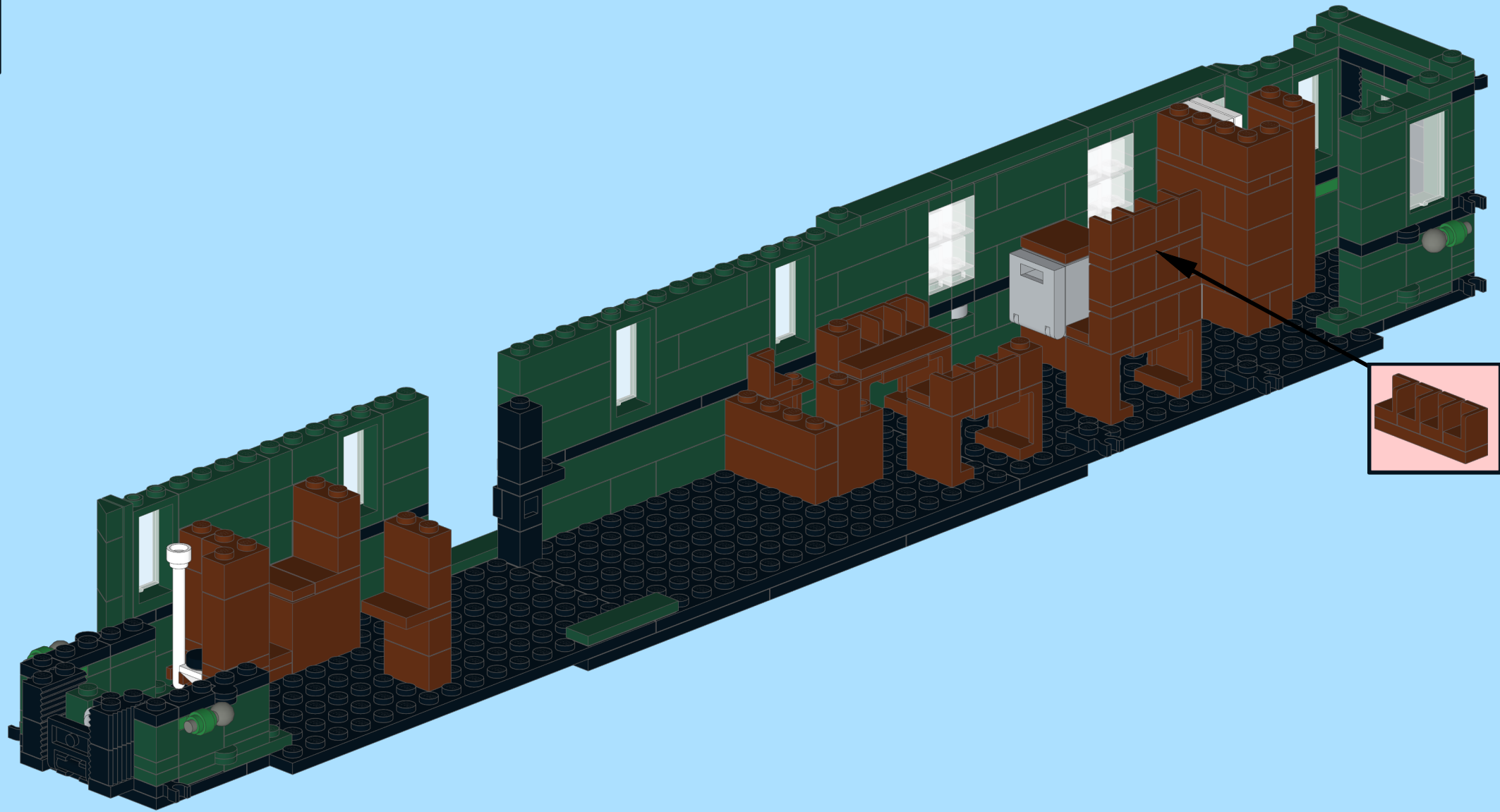
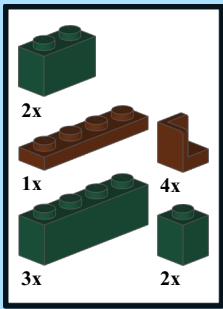

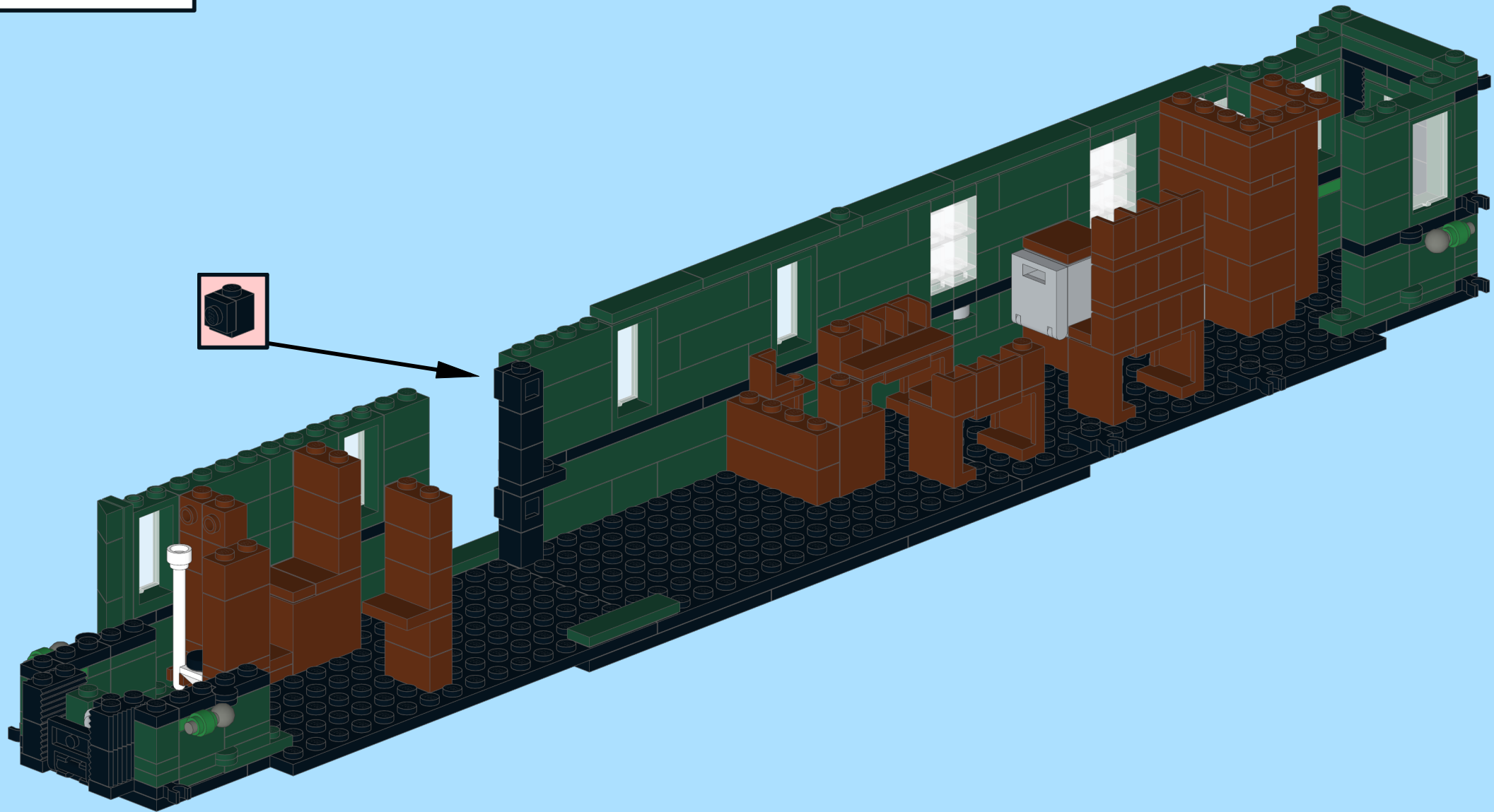
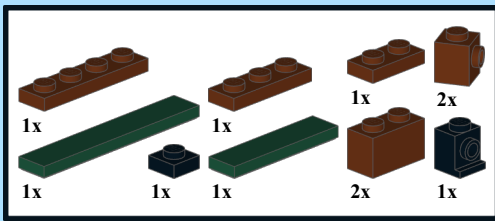

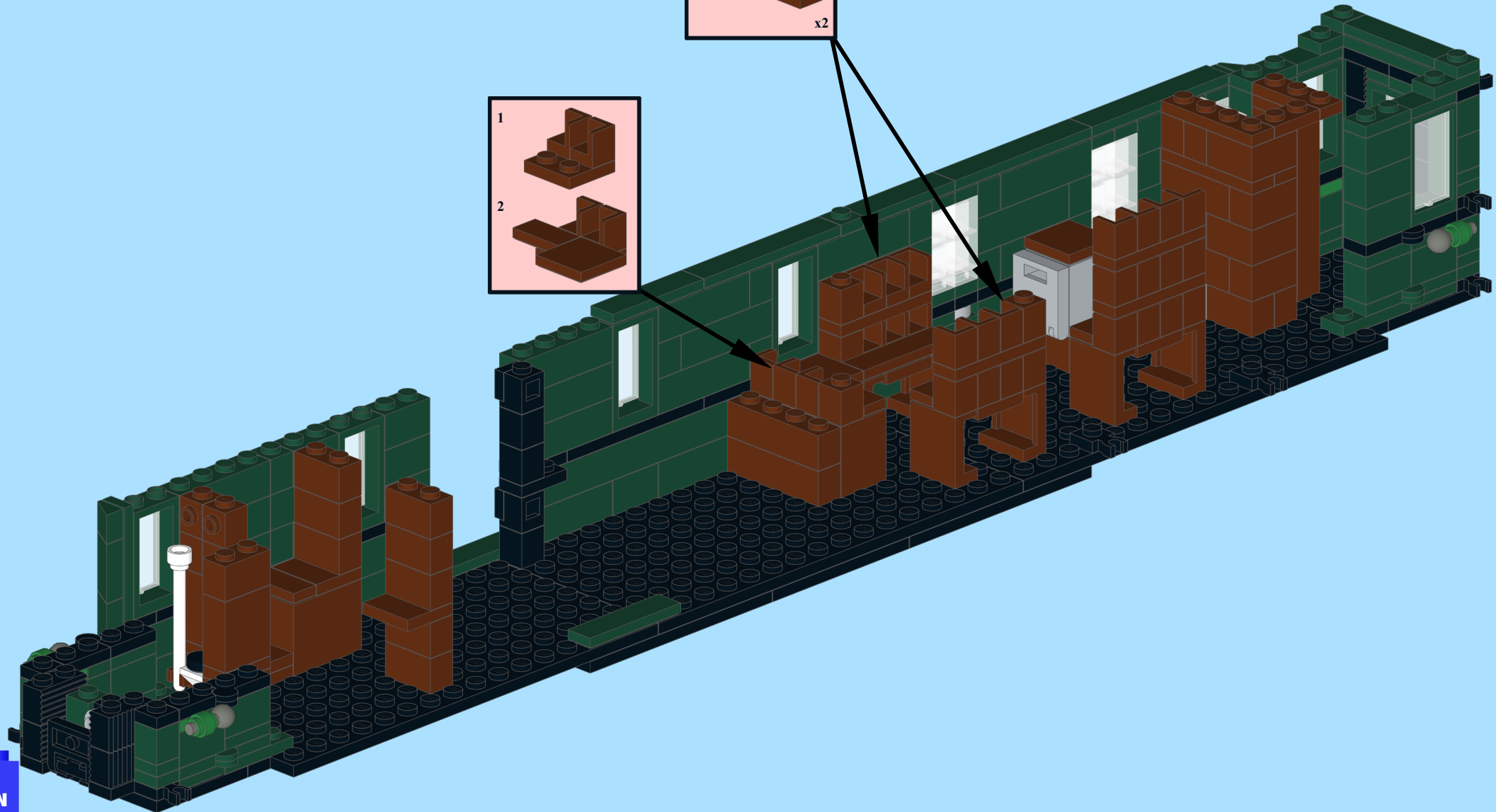
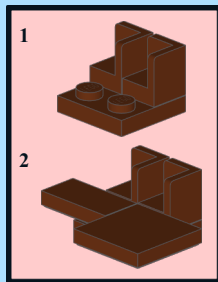
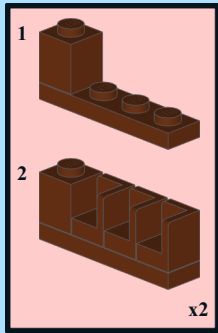
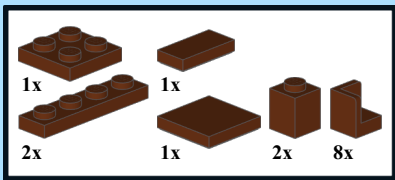

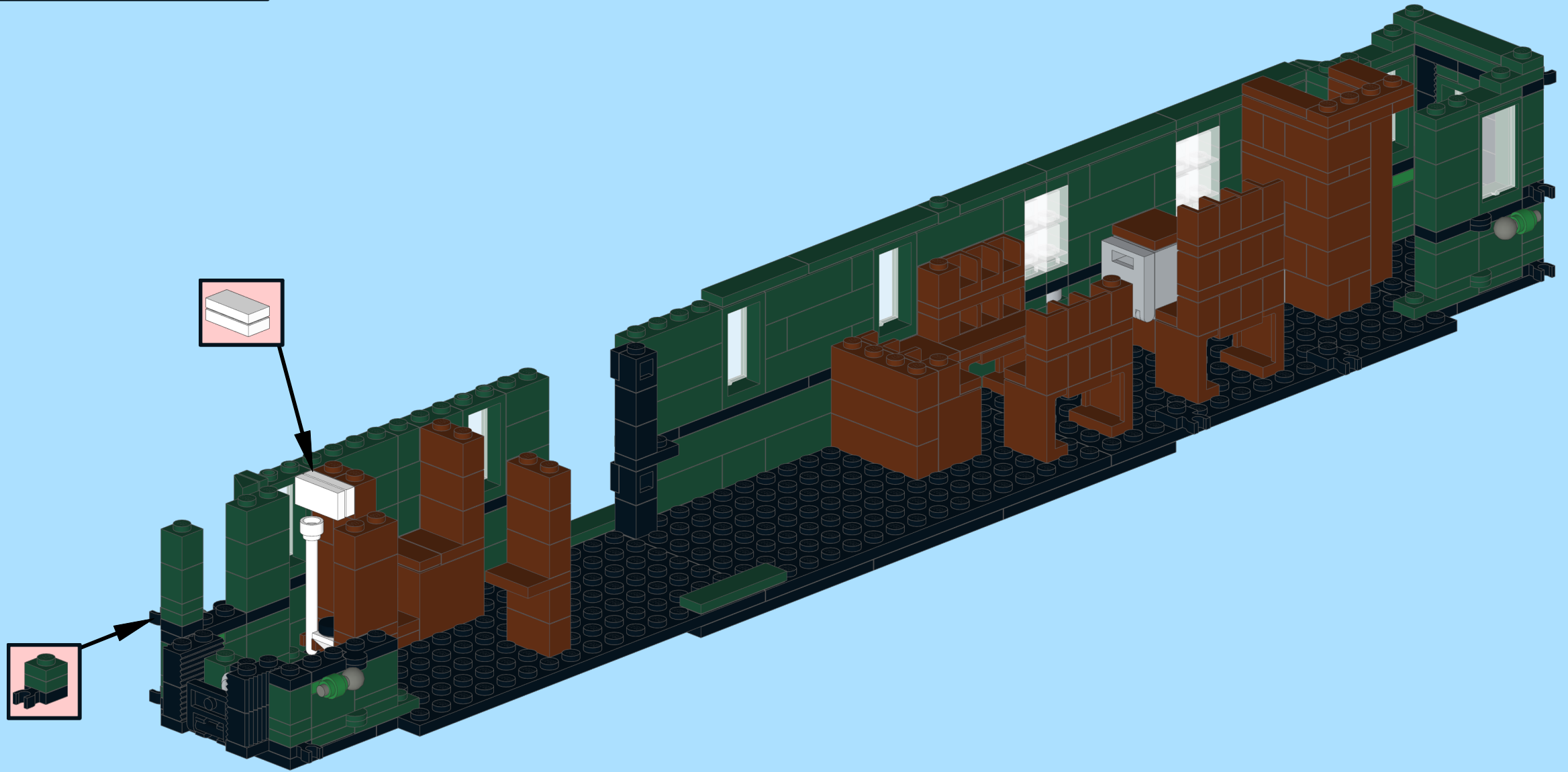
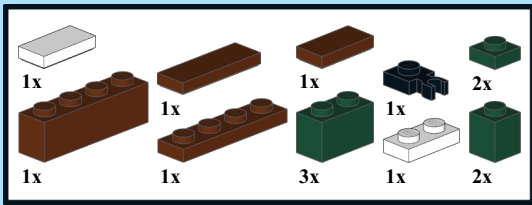

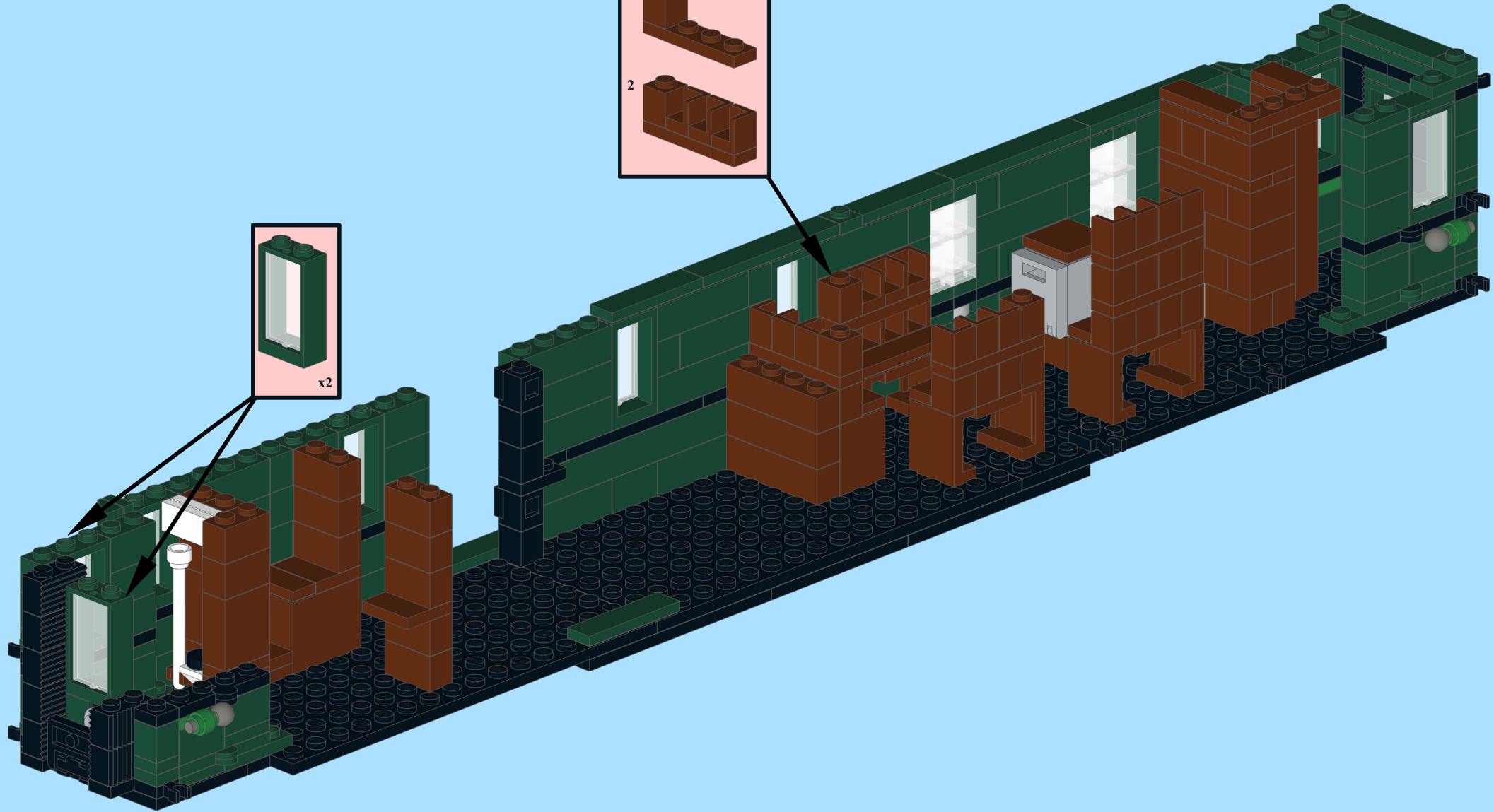
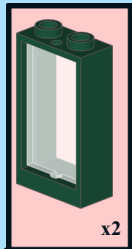
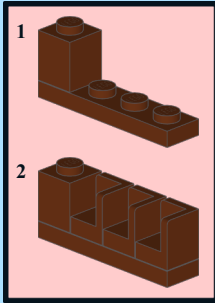
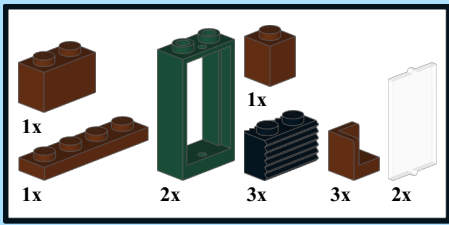

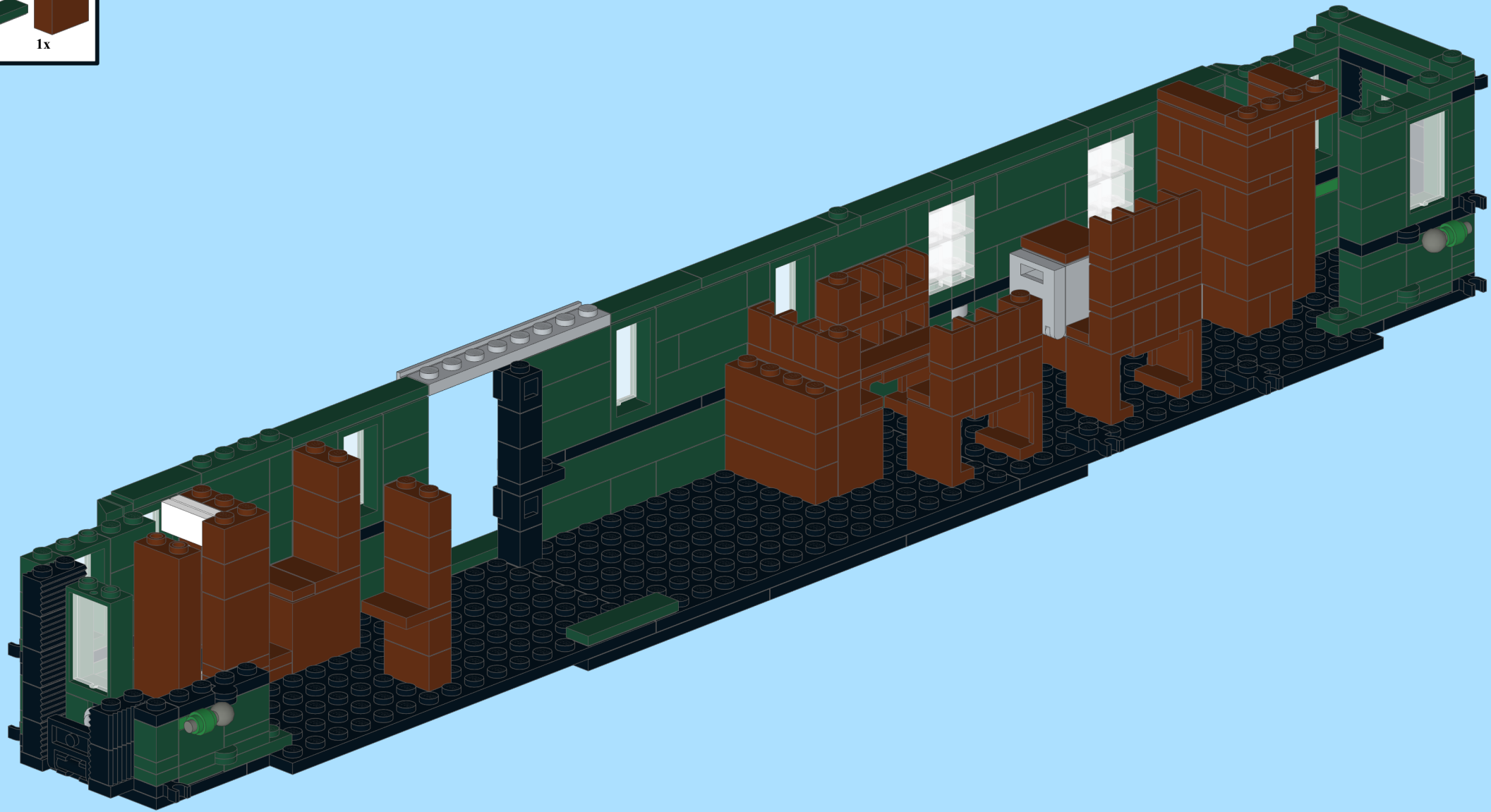
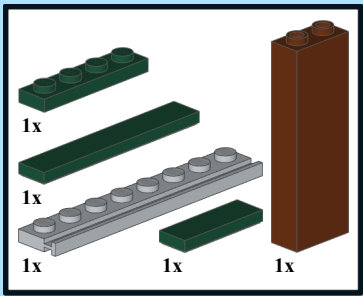

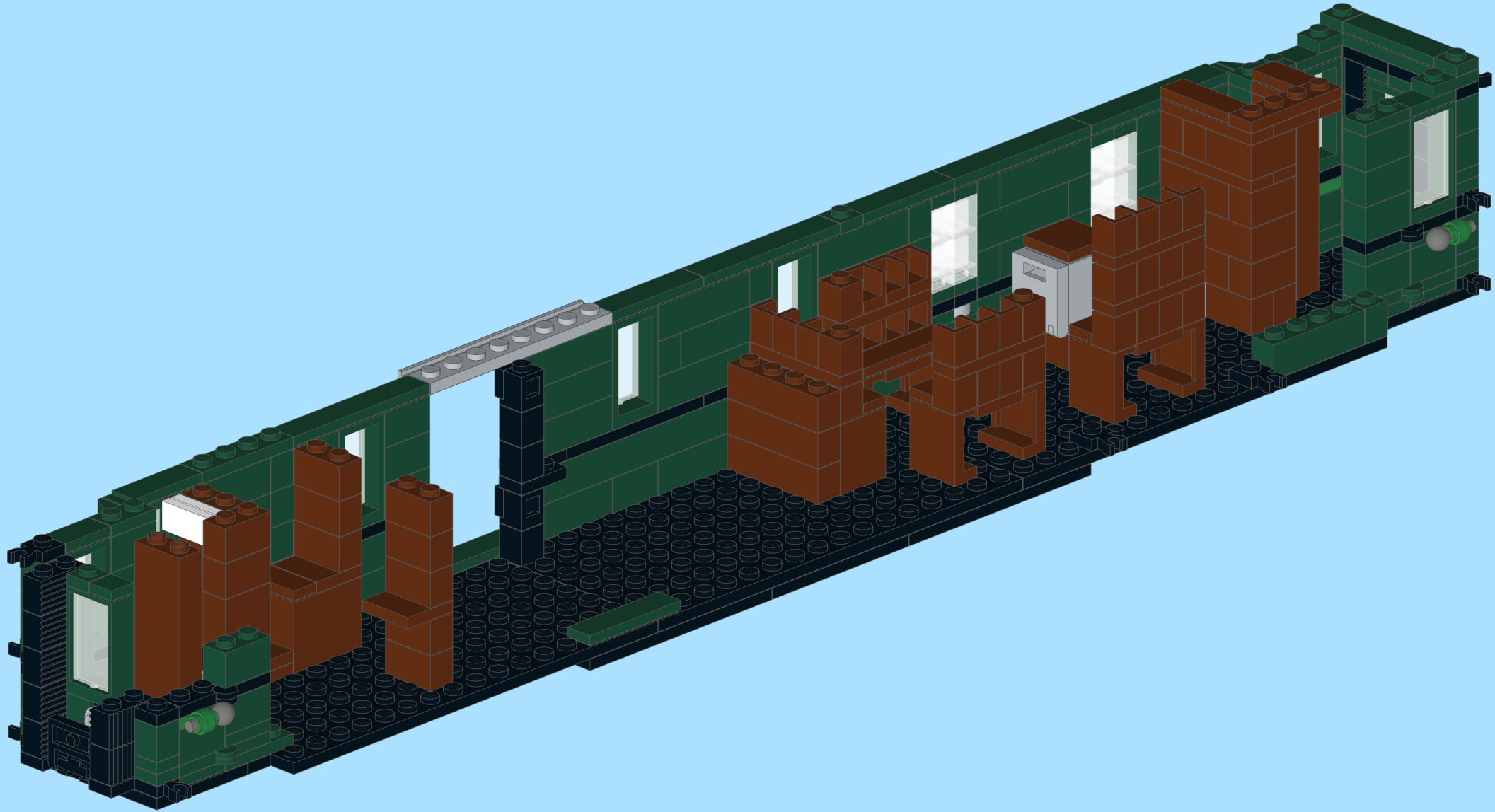
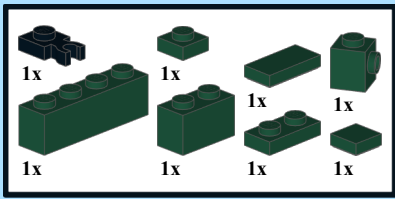

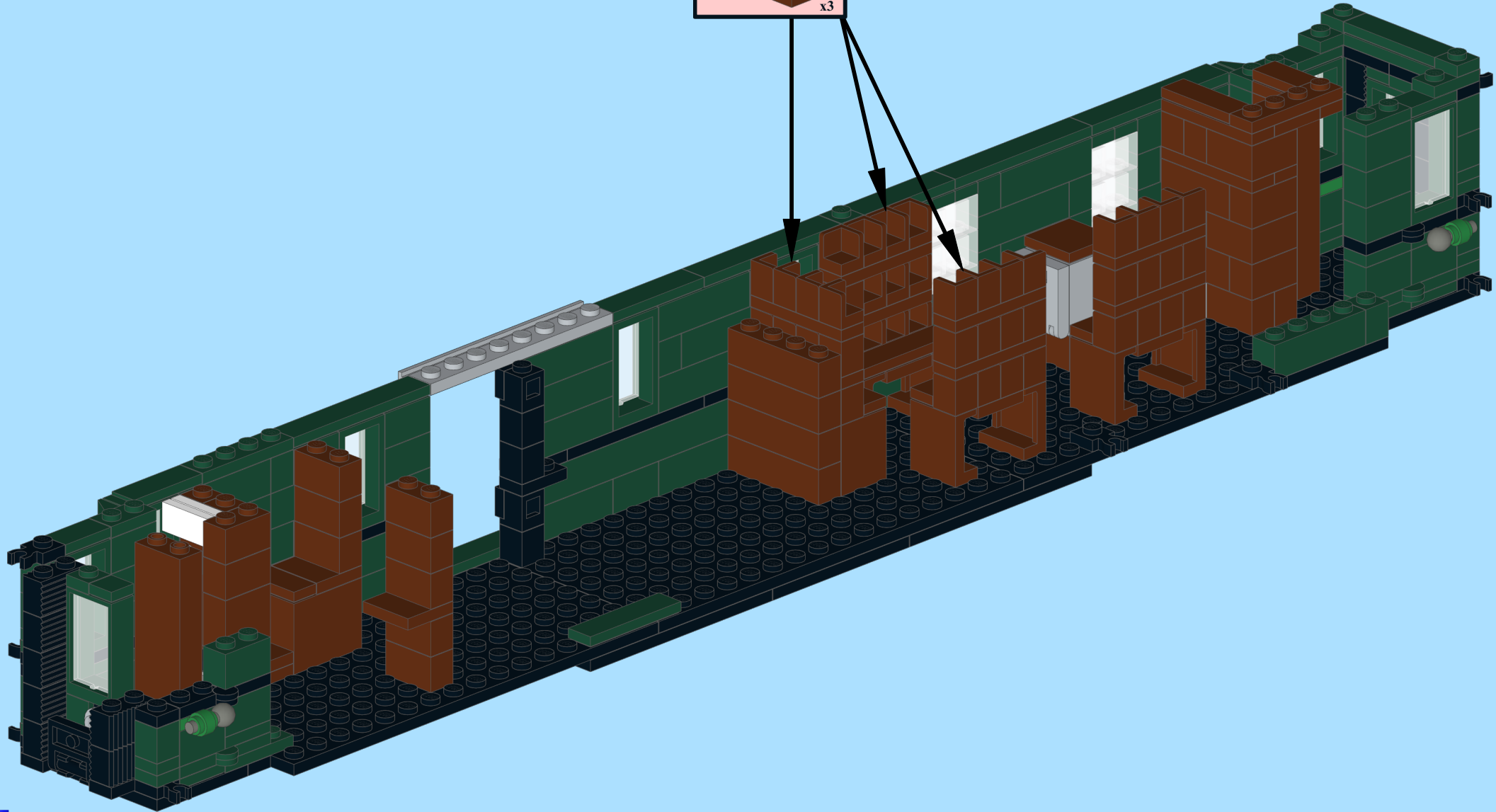
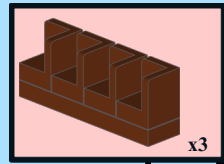
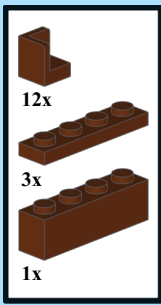

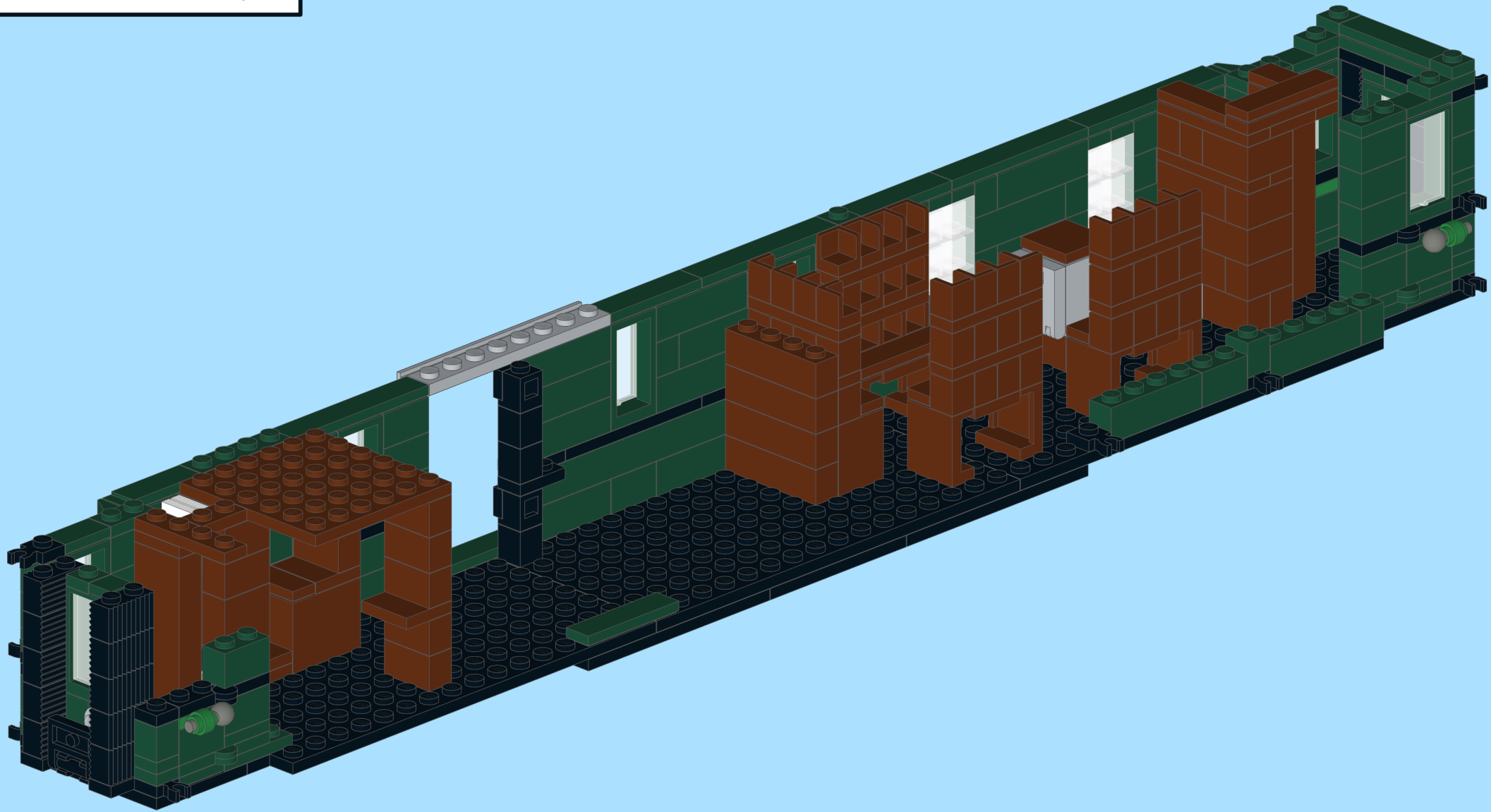
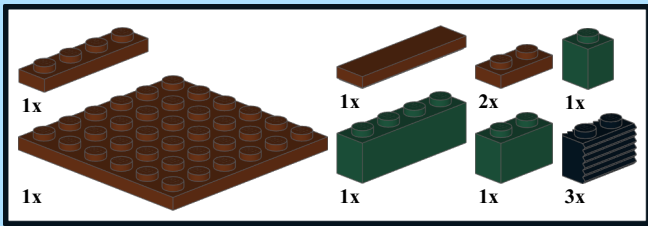

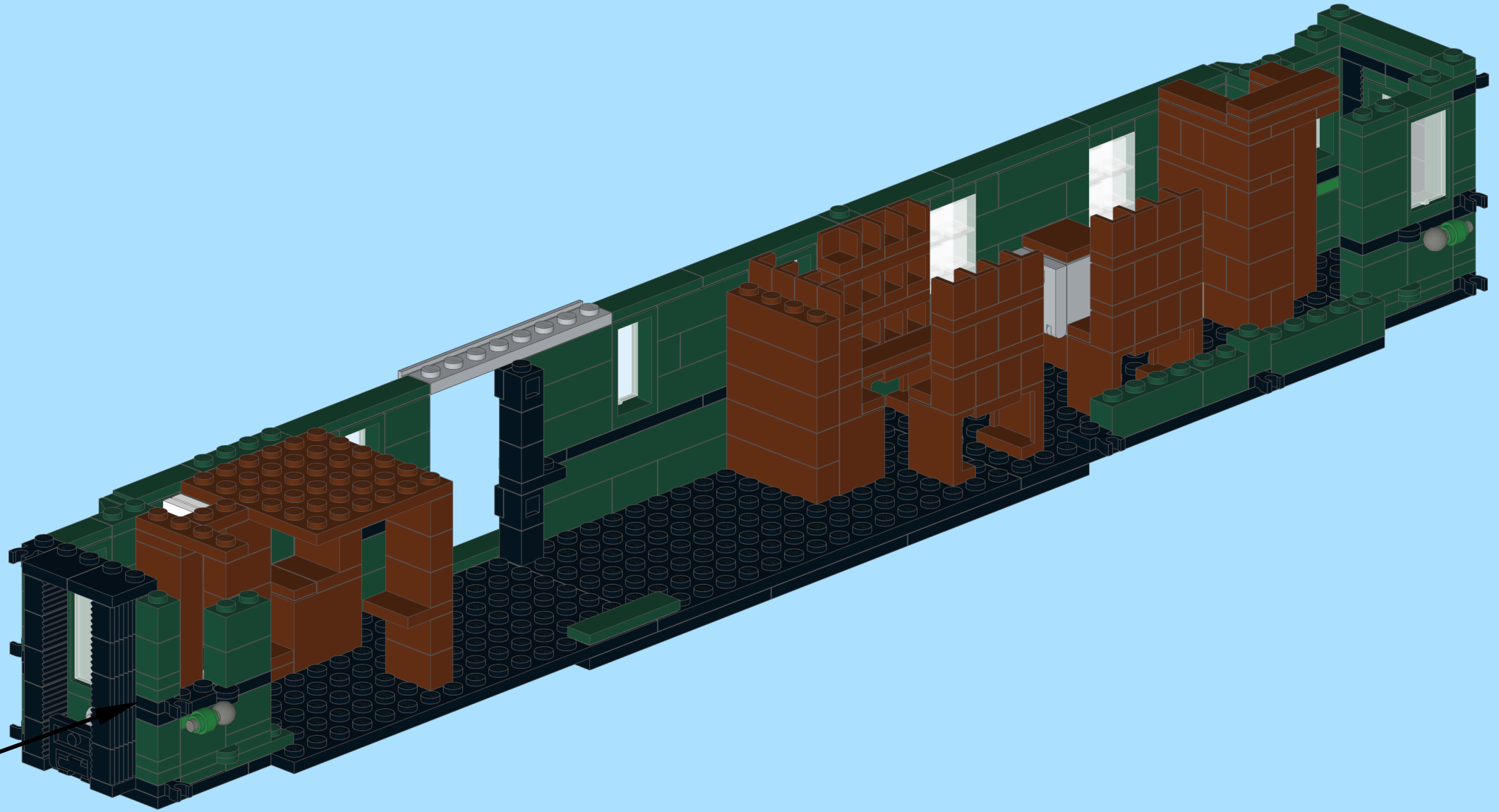
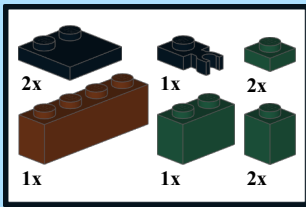

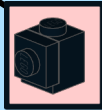
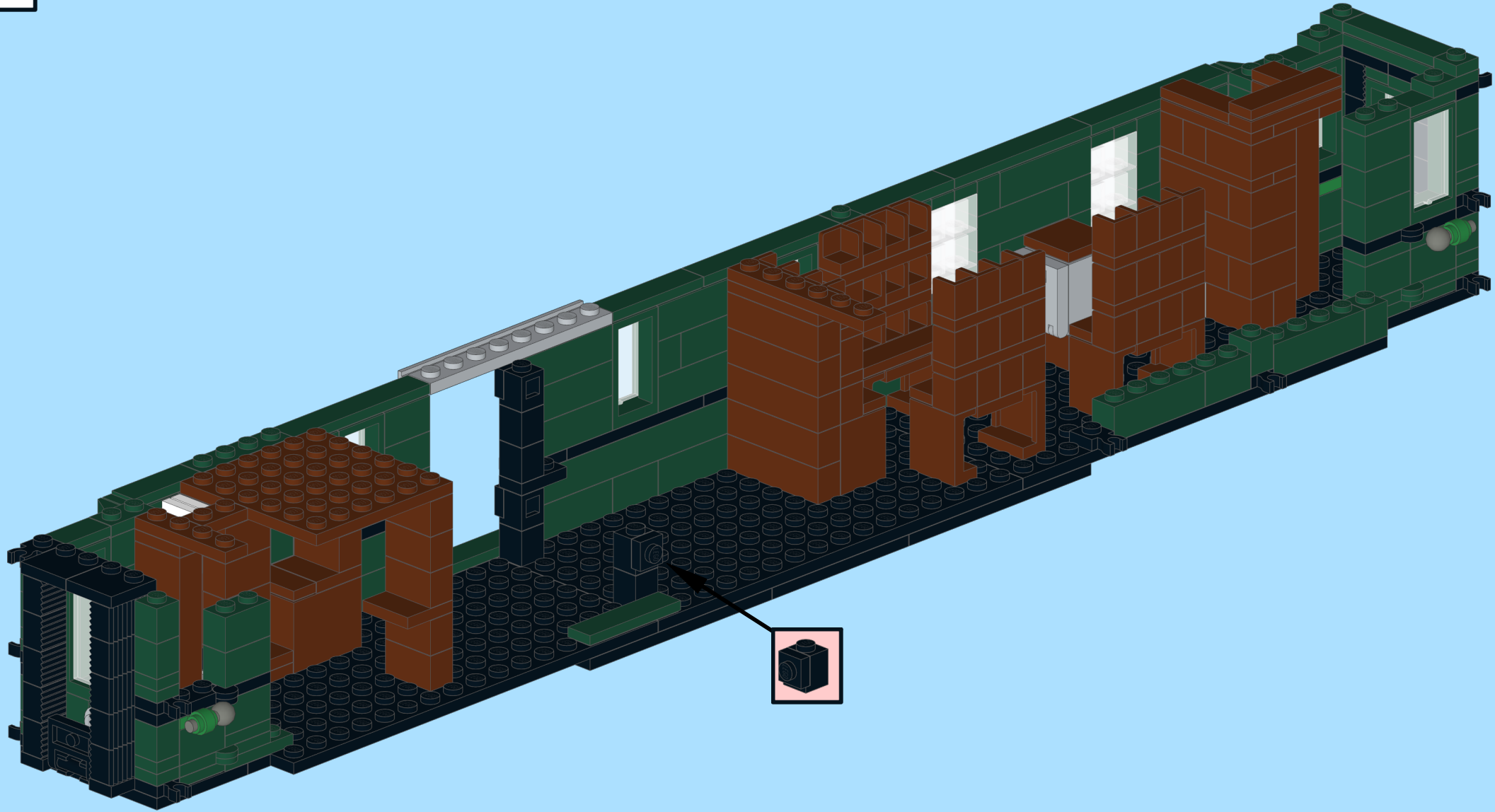
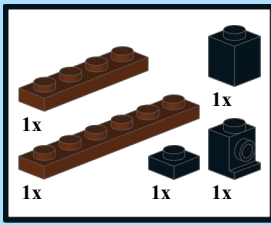

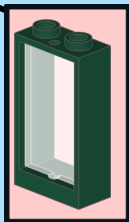
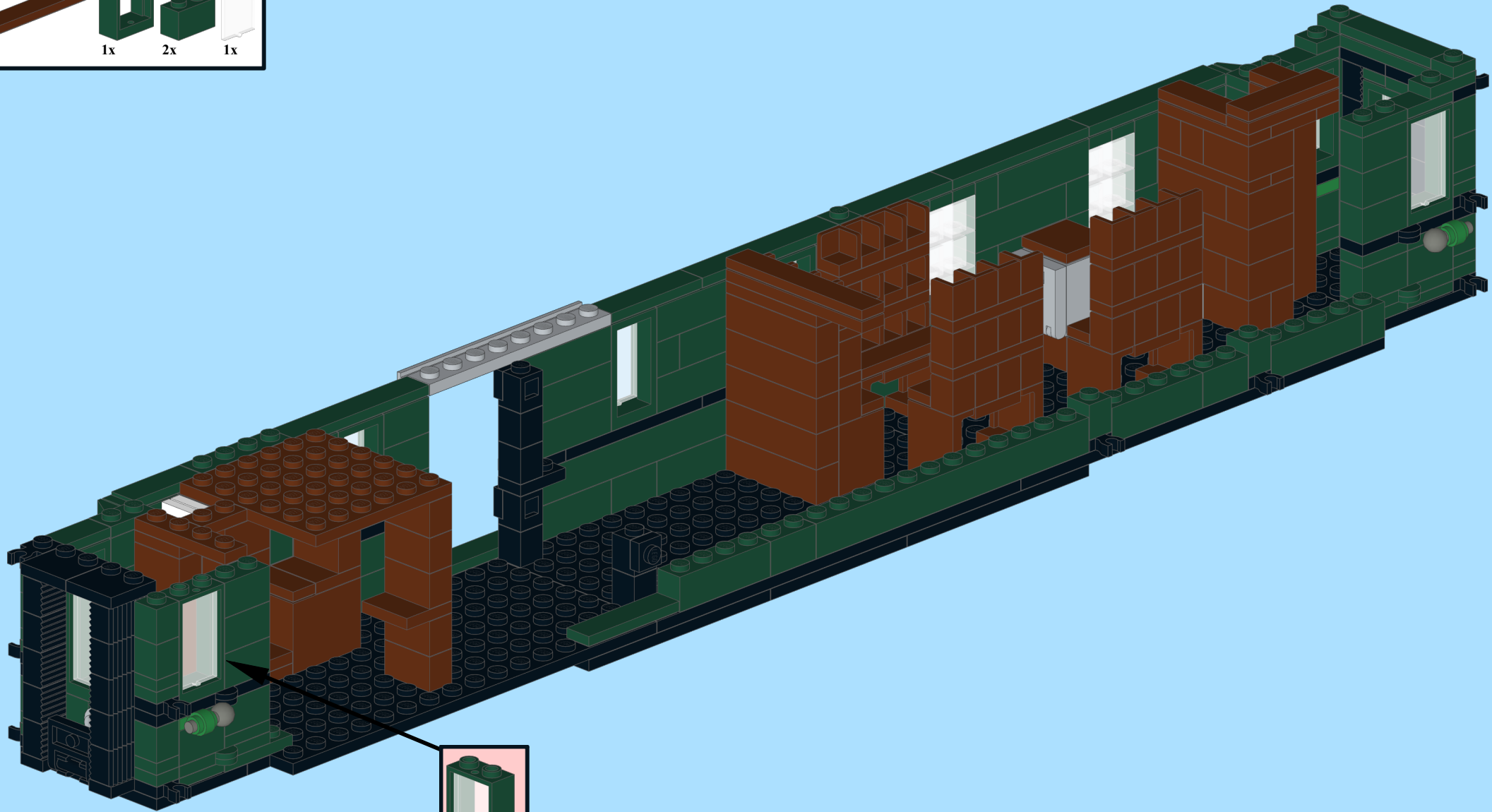
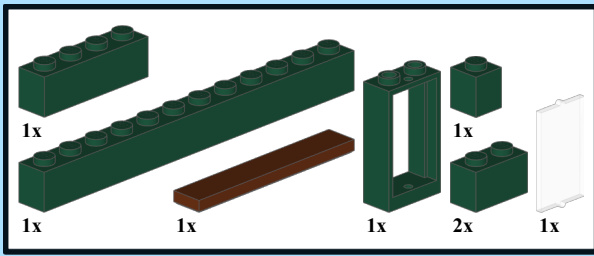







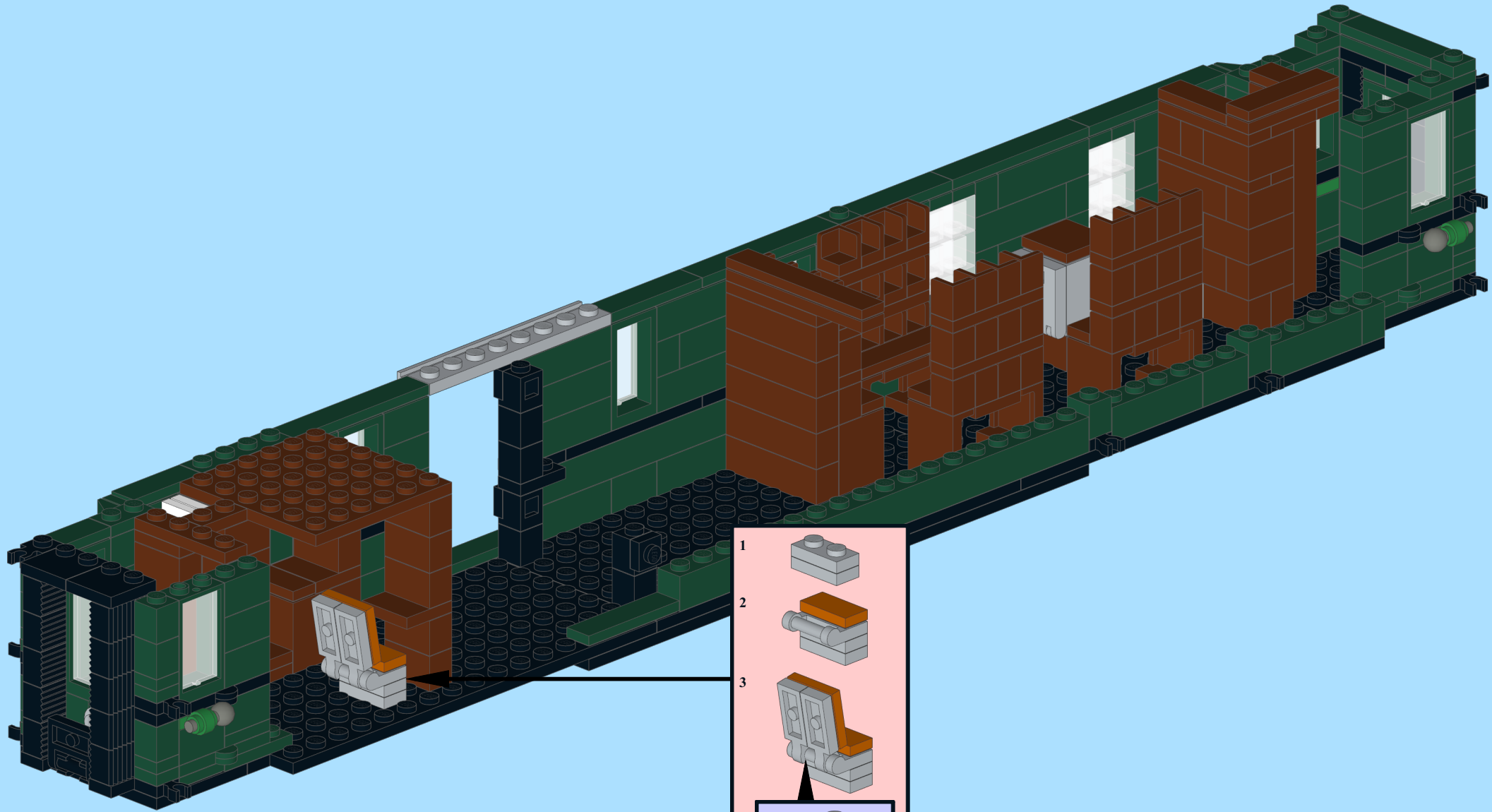

-  1x
-  2x
-  2x
-  1x
-  1x

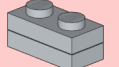

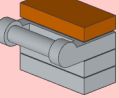
1 

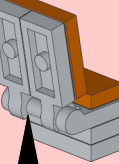
2 

3 

1 

2 

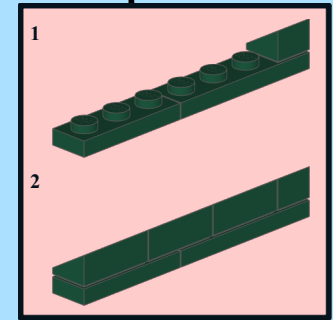
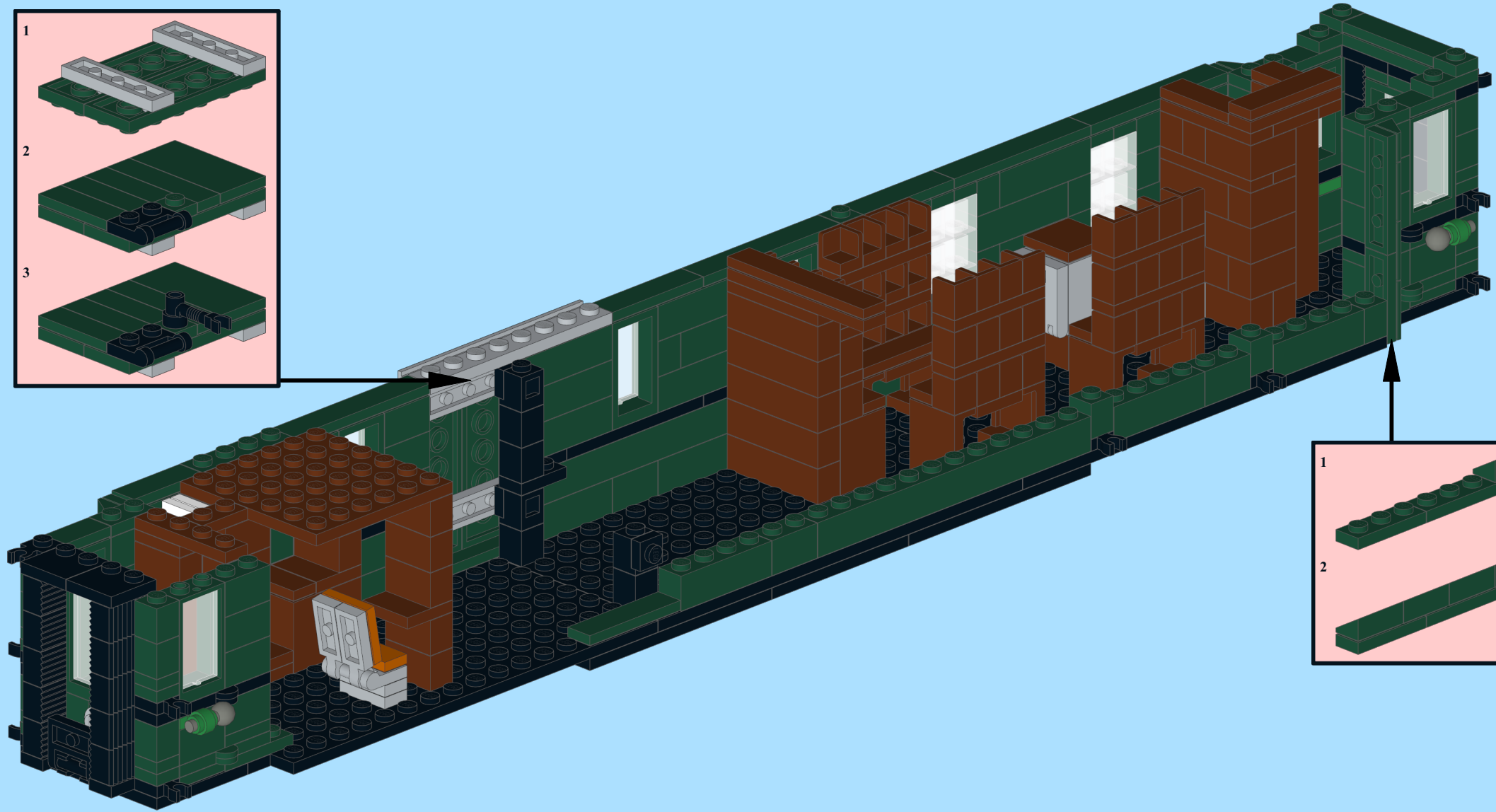
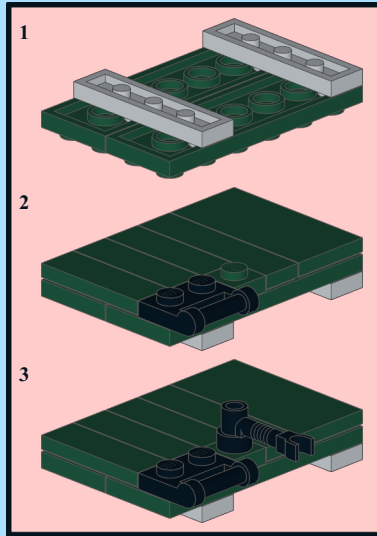
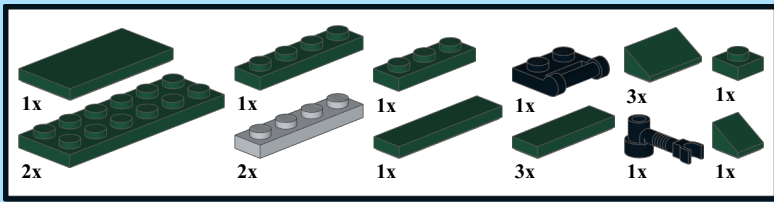

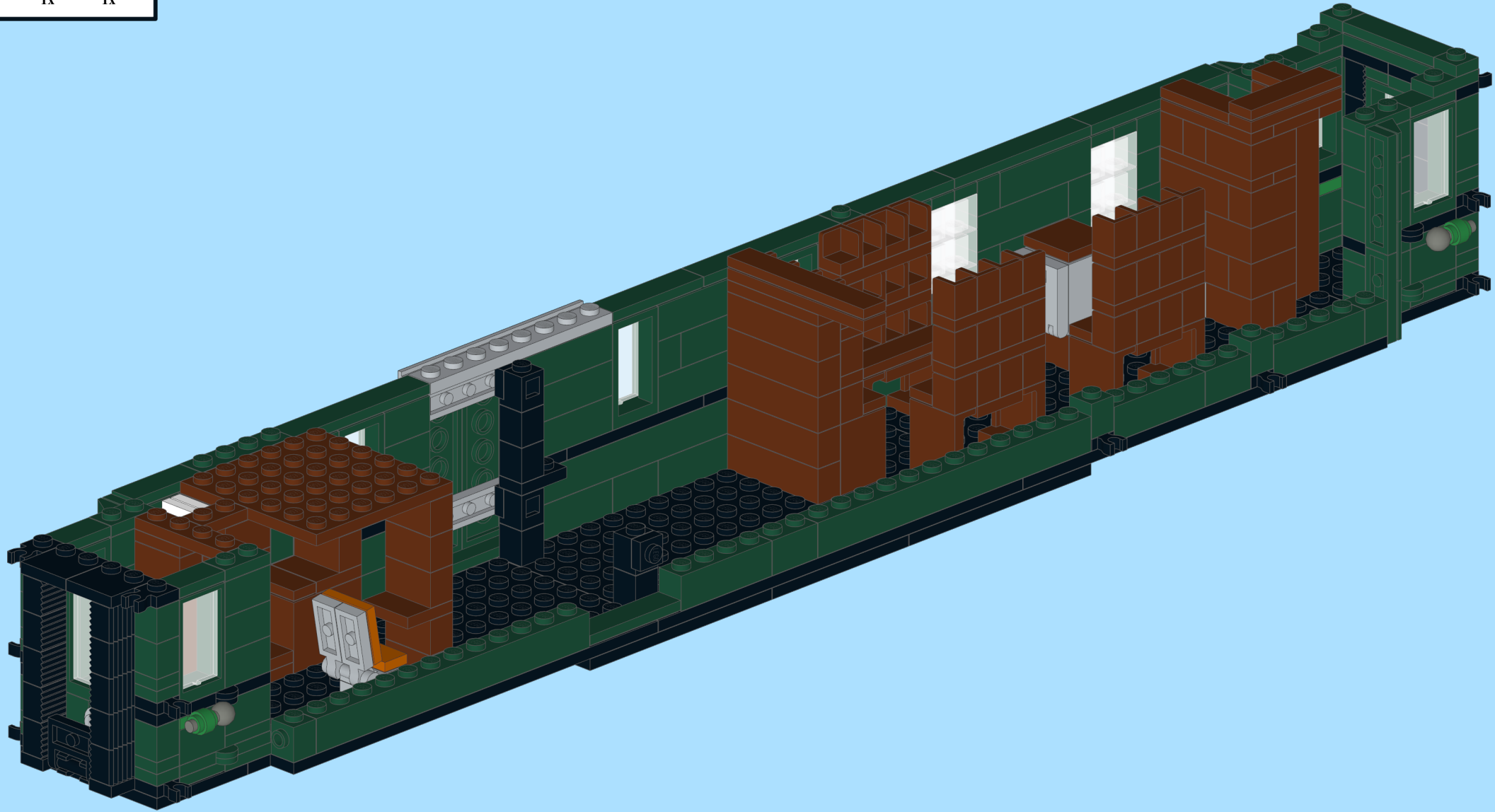
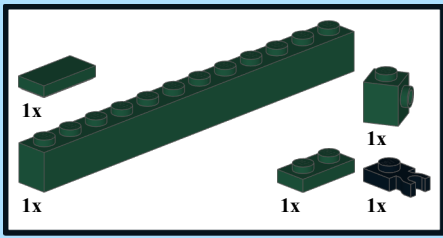

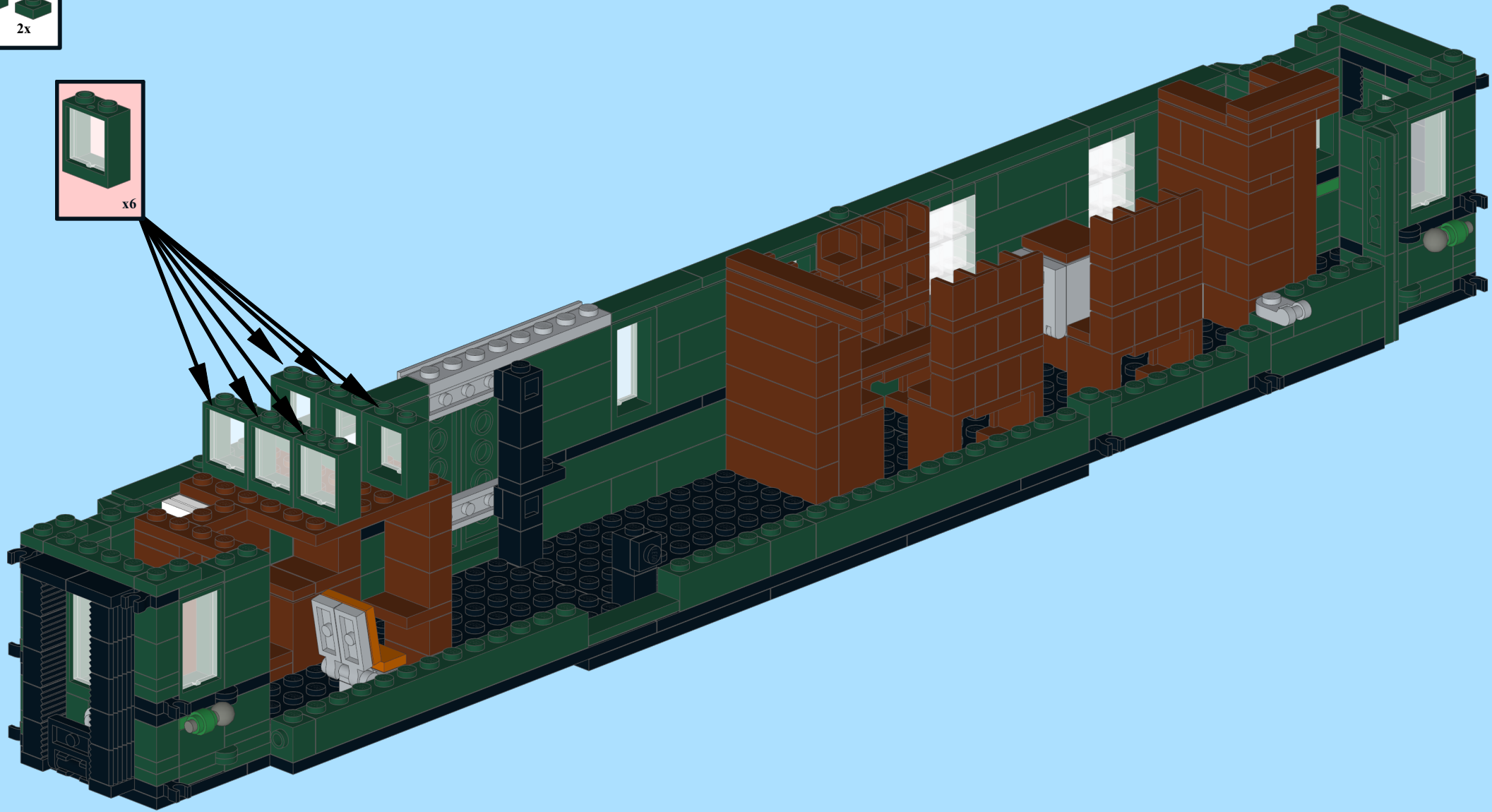
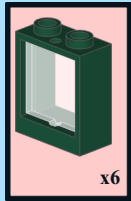
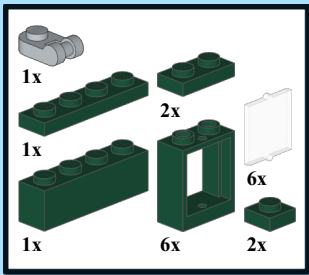

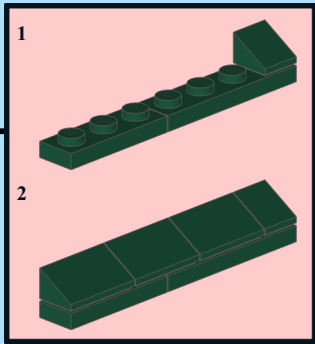
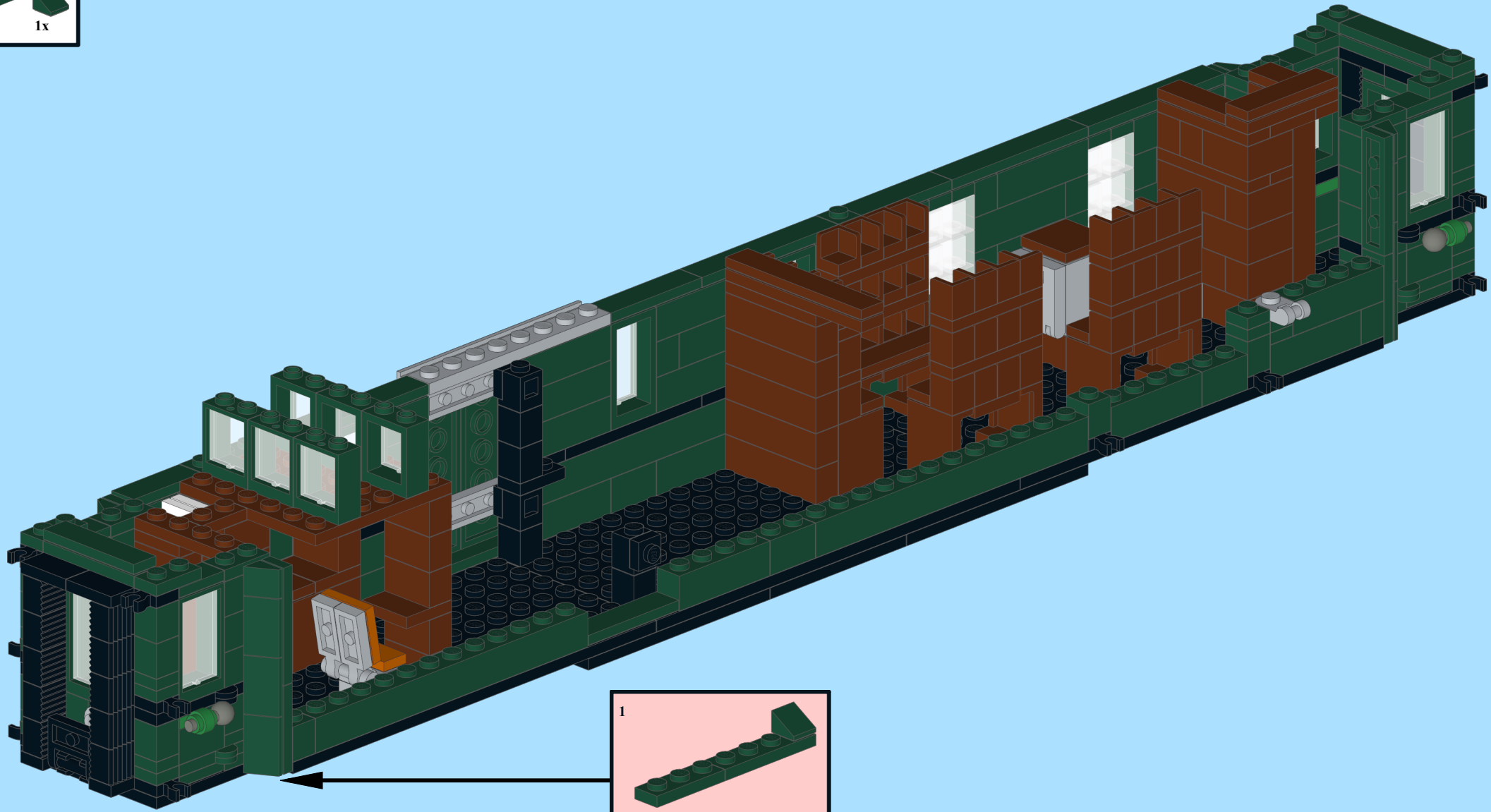
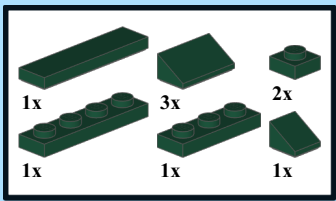

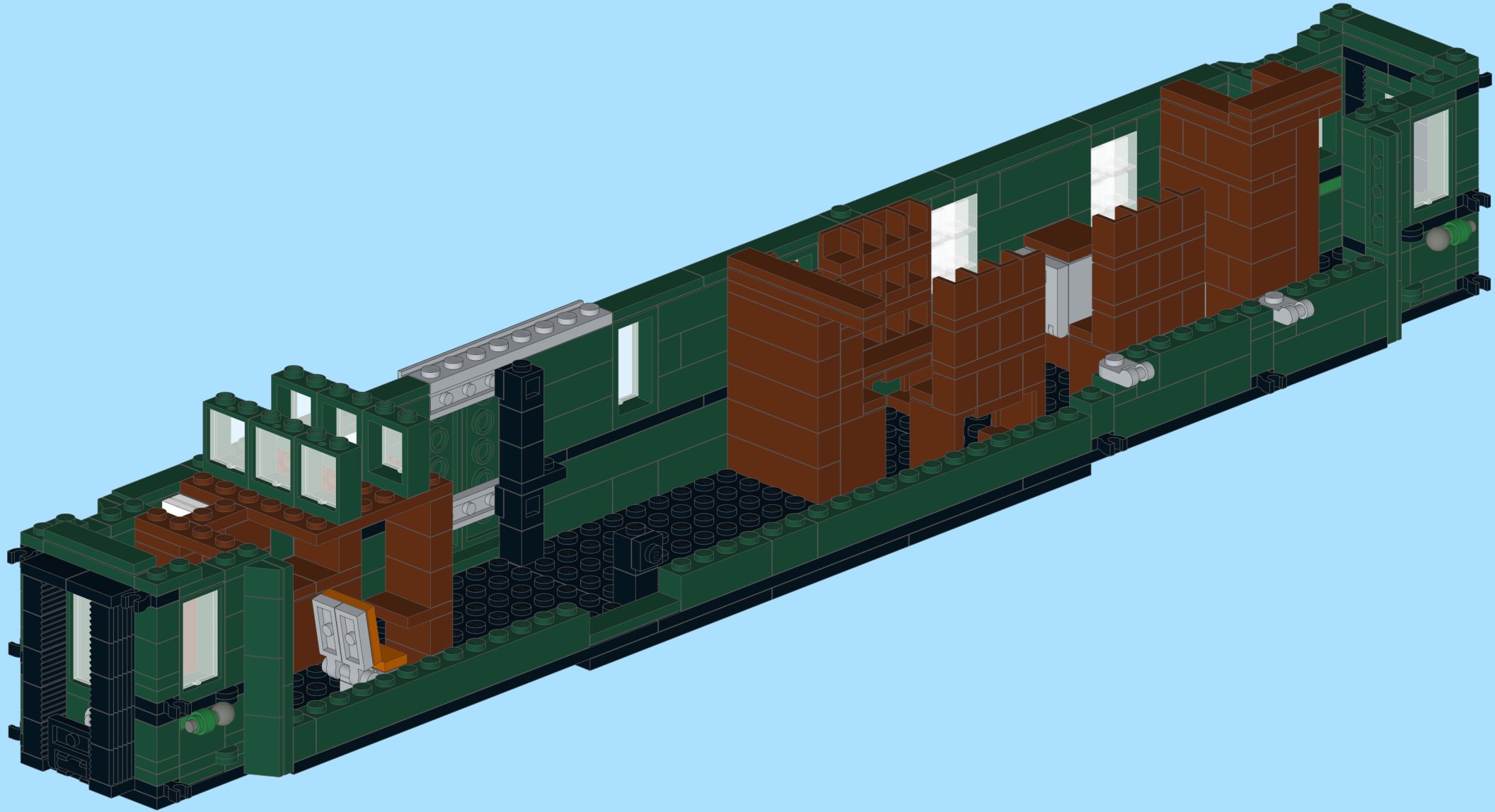
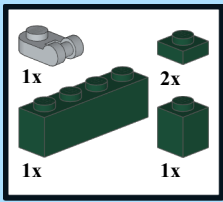

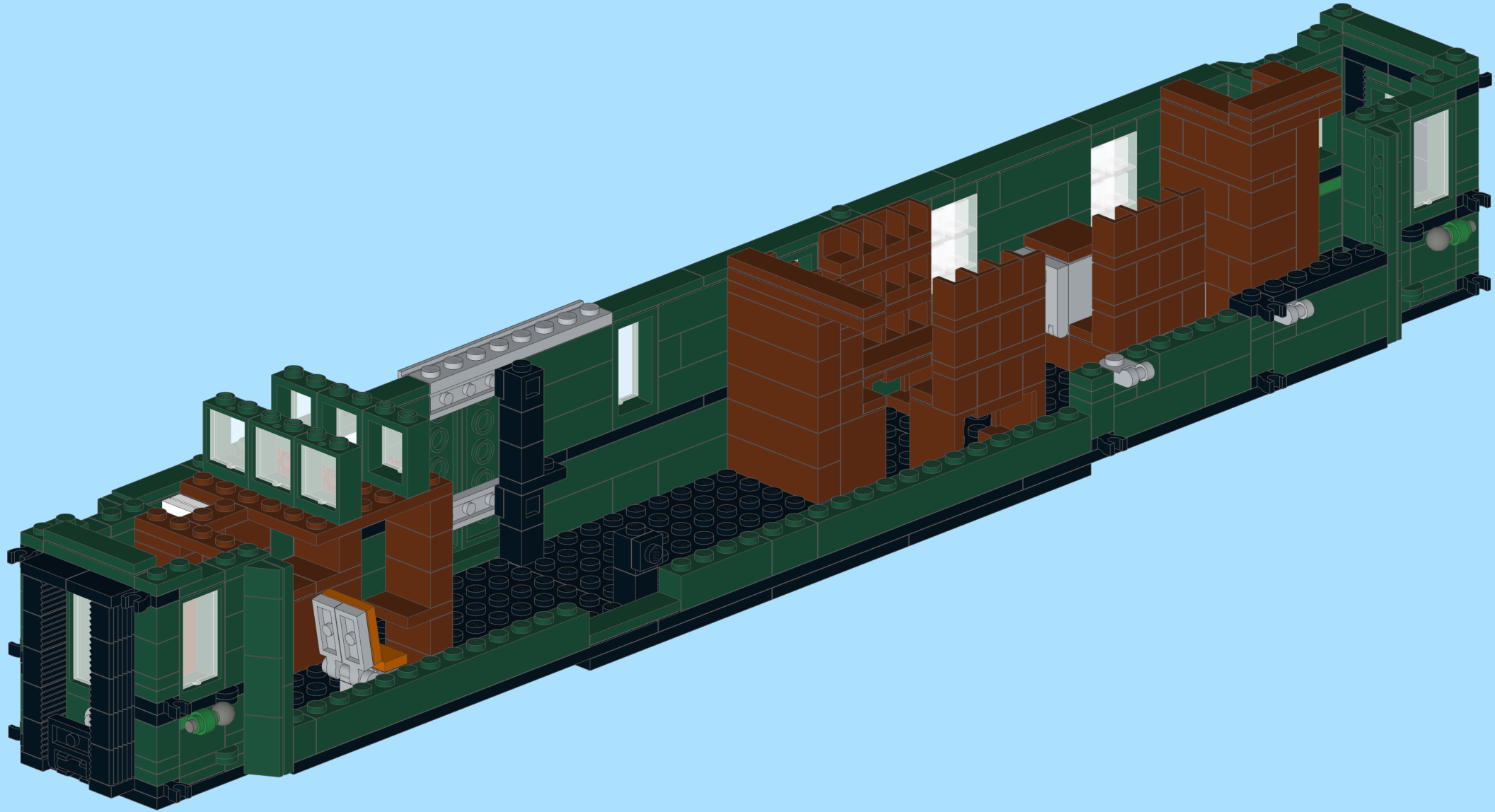
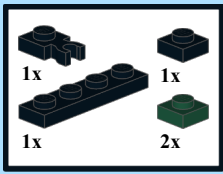

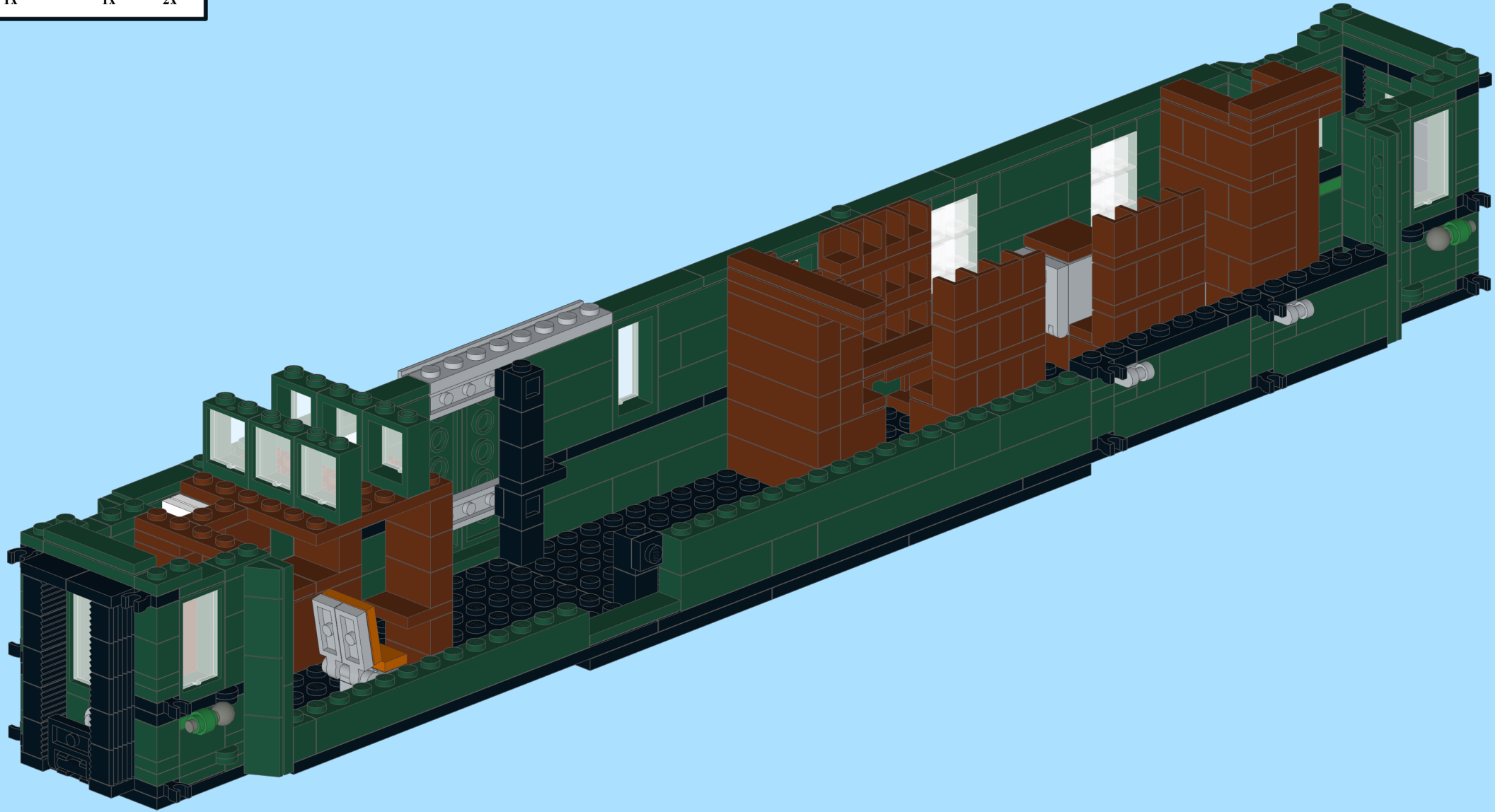
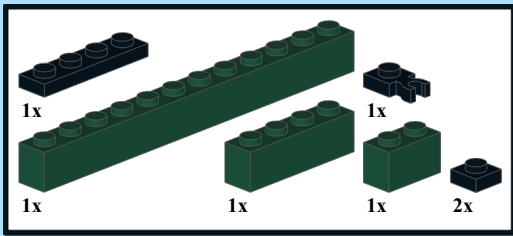

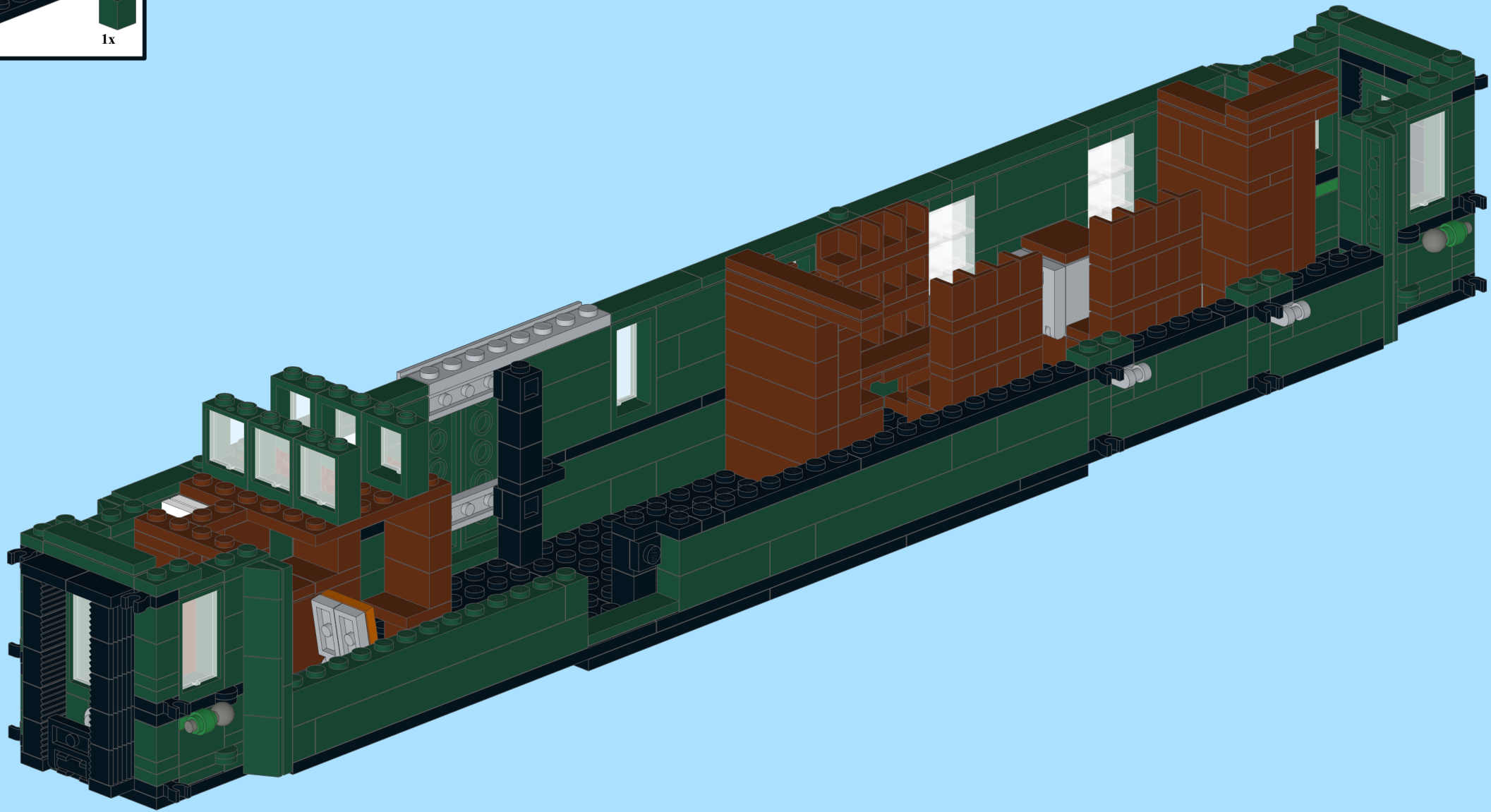
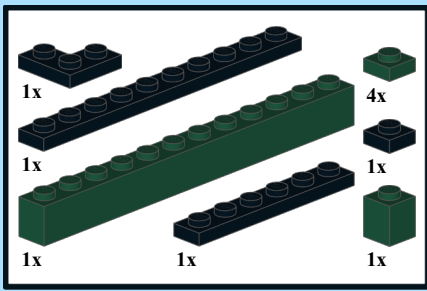

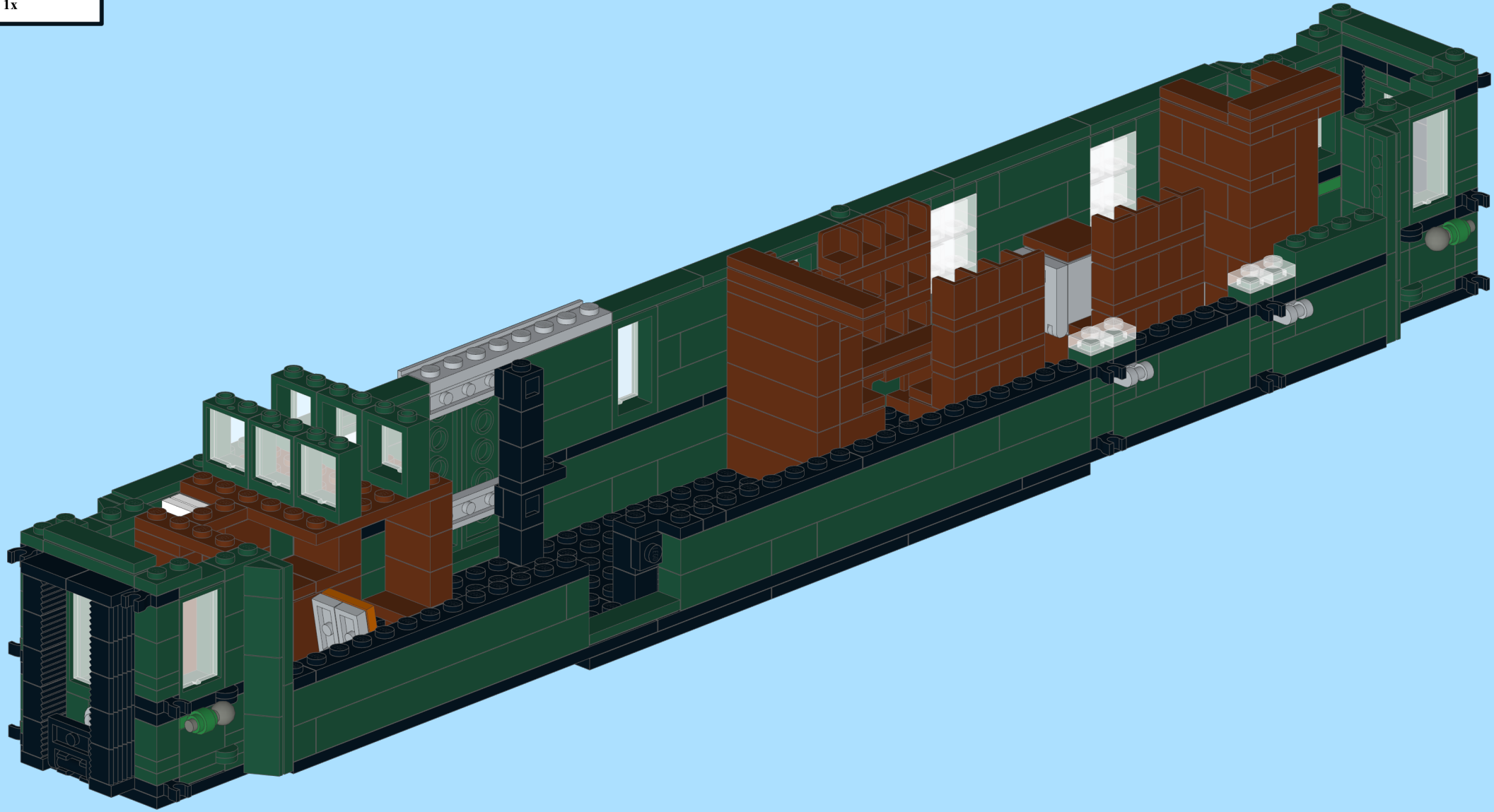
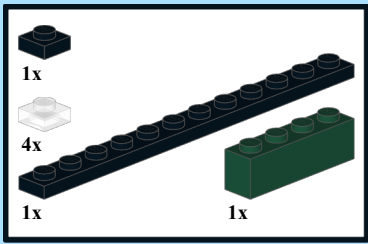

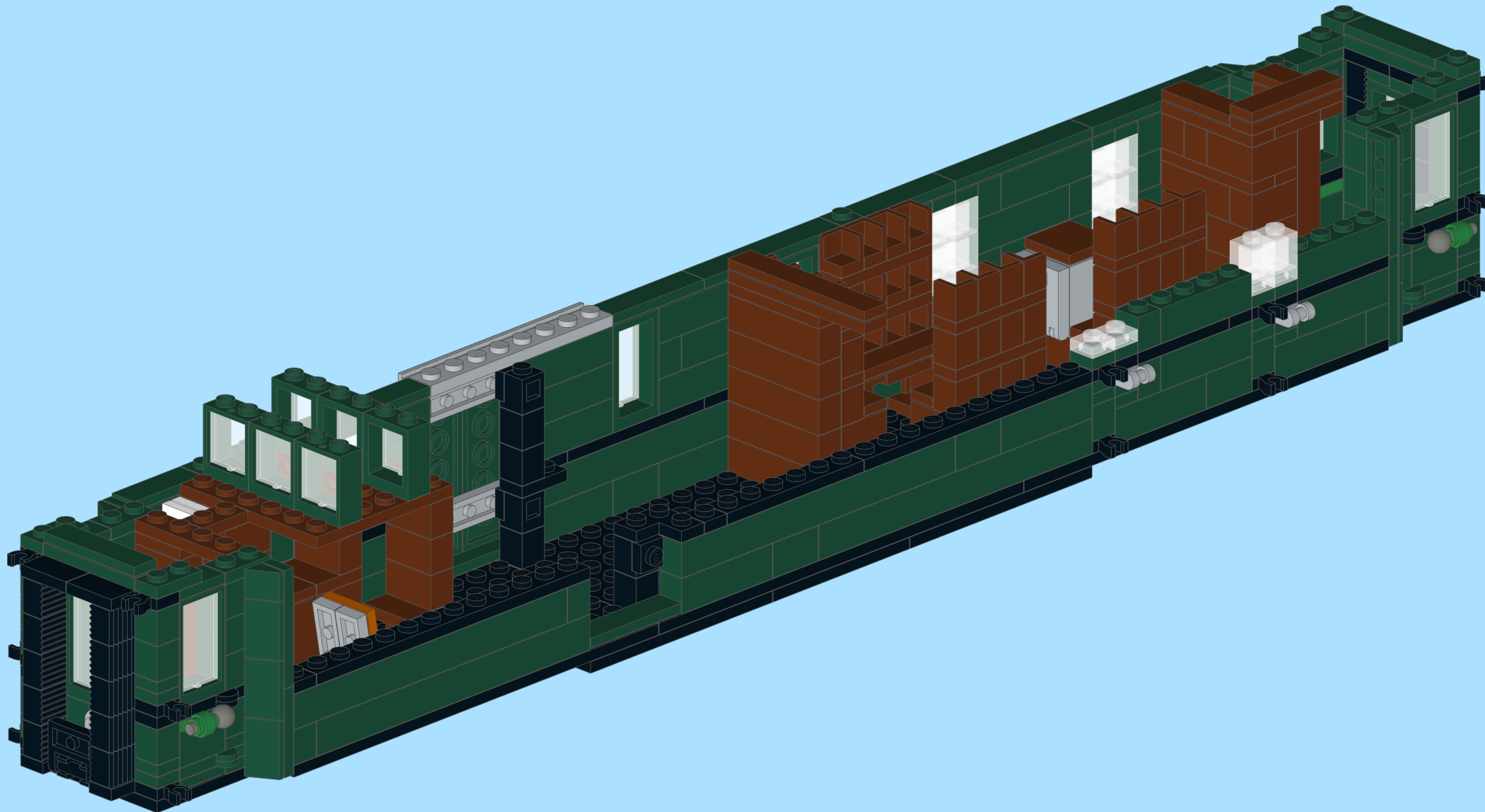
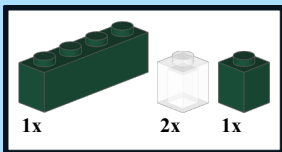

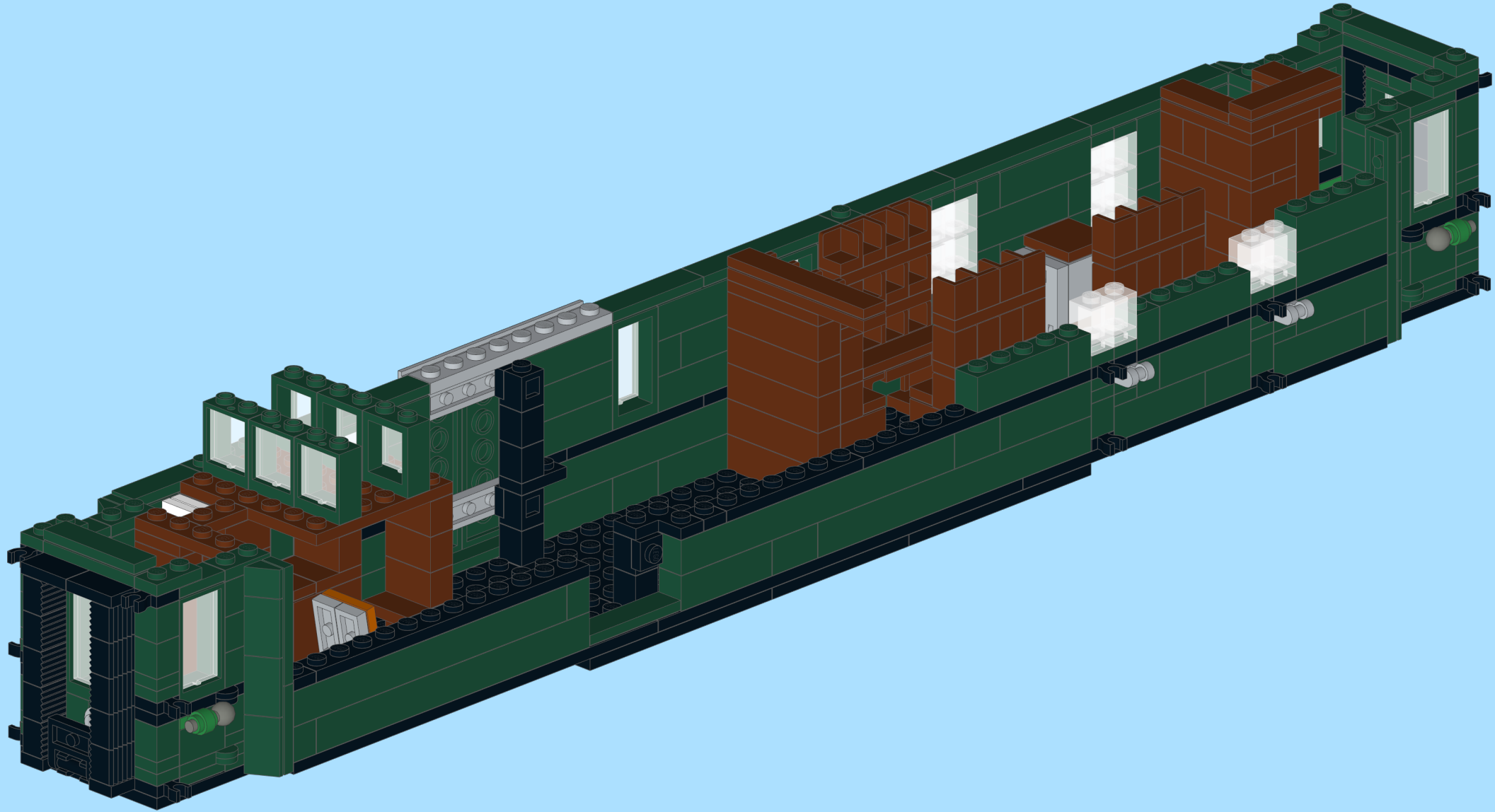
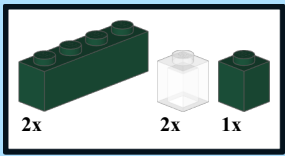

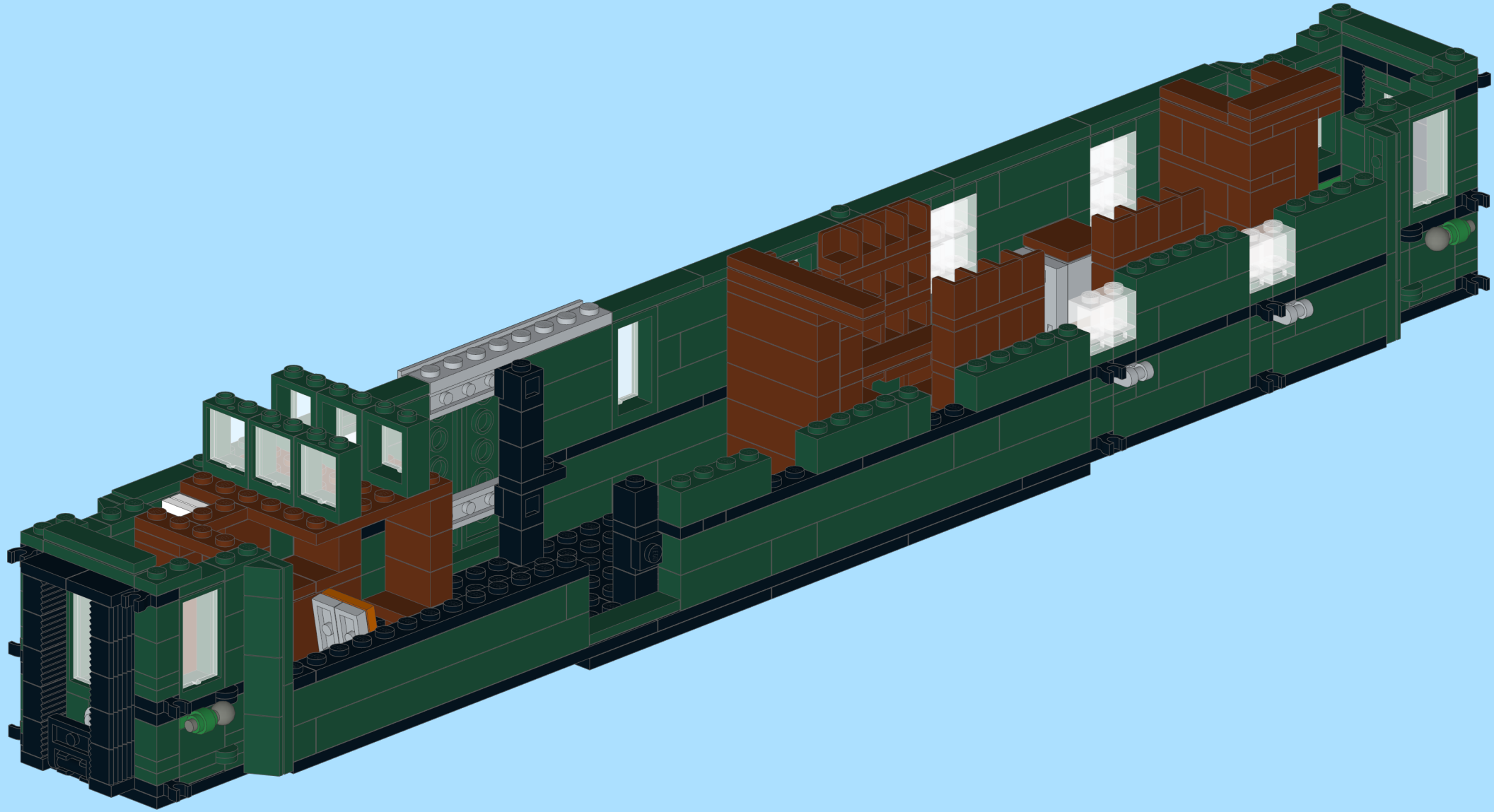
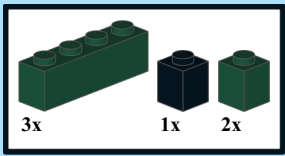

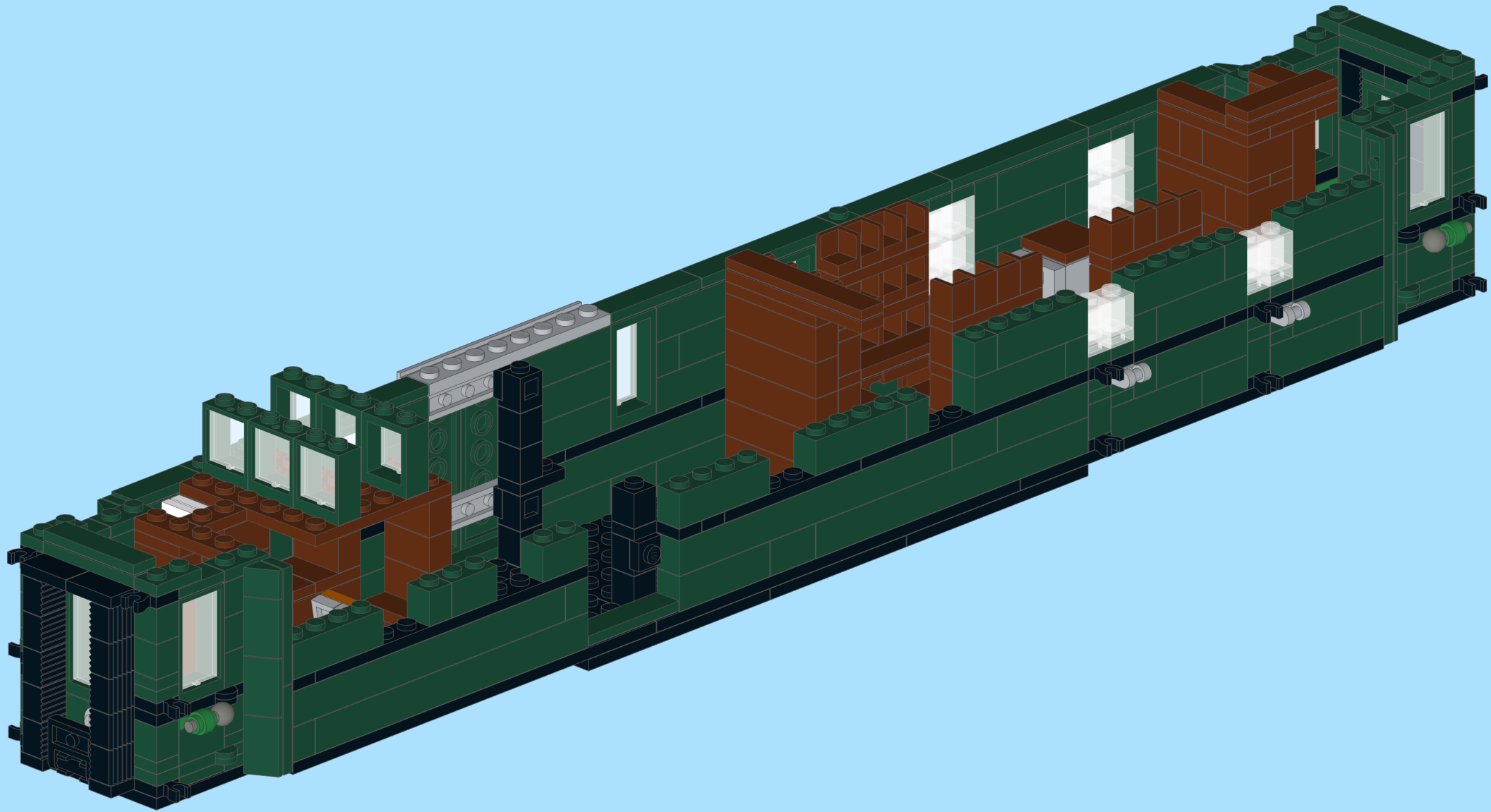
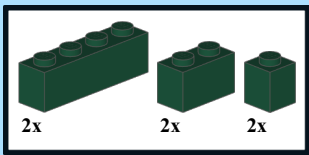

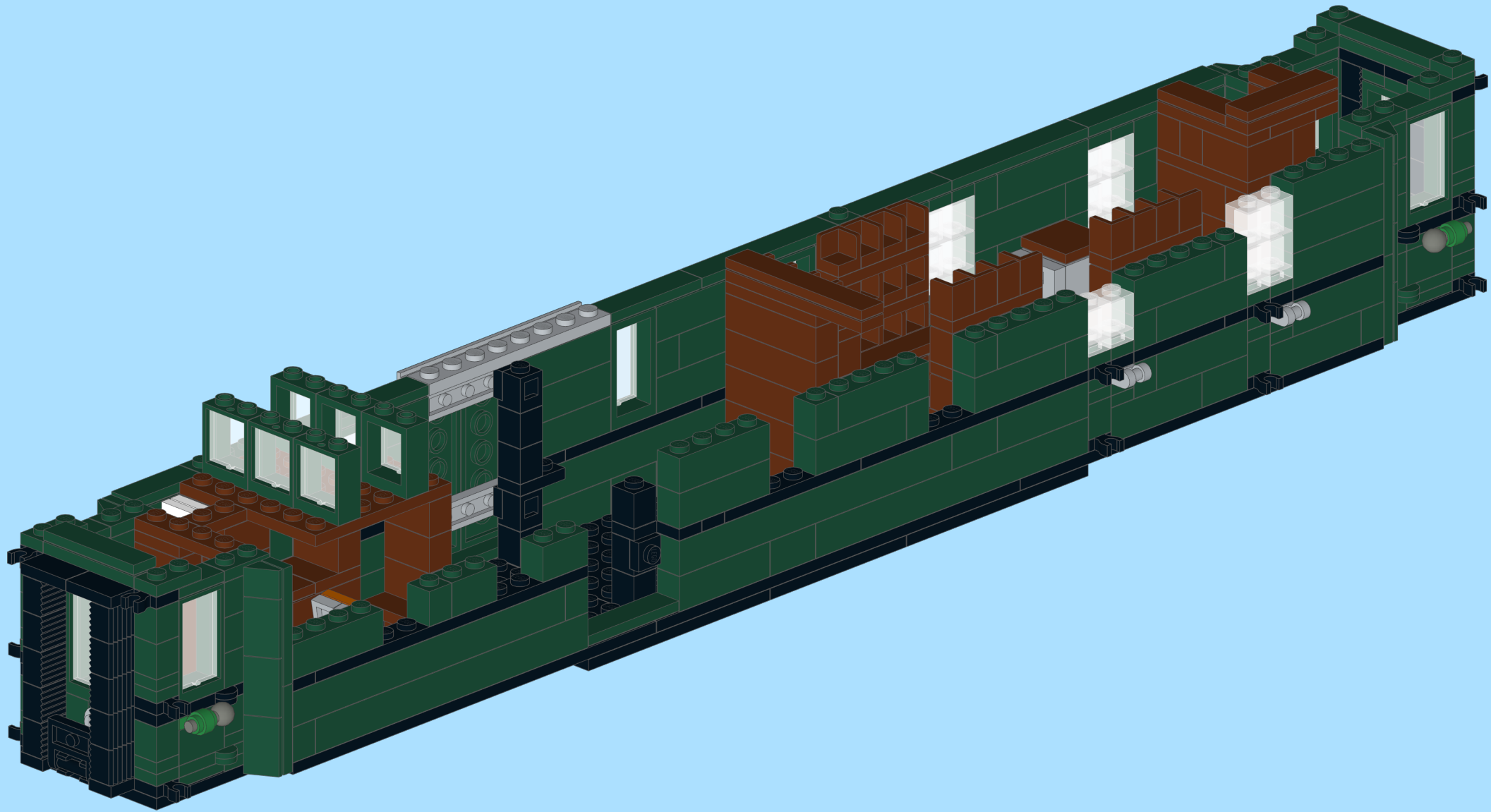
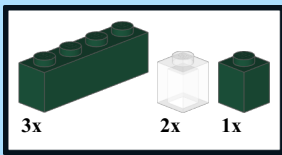

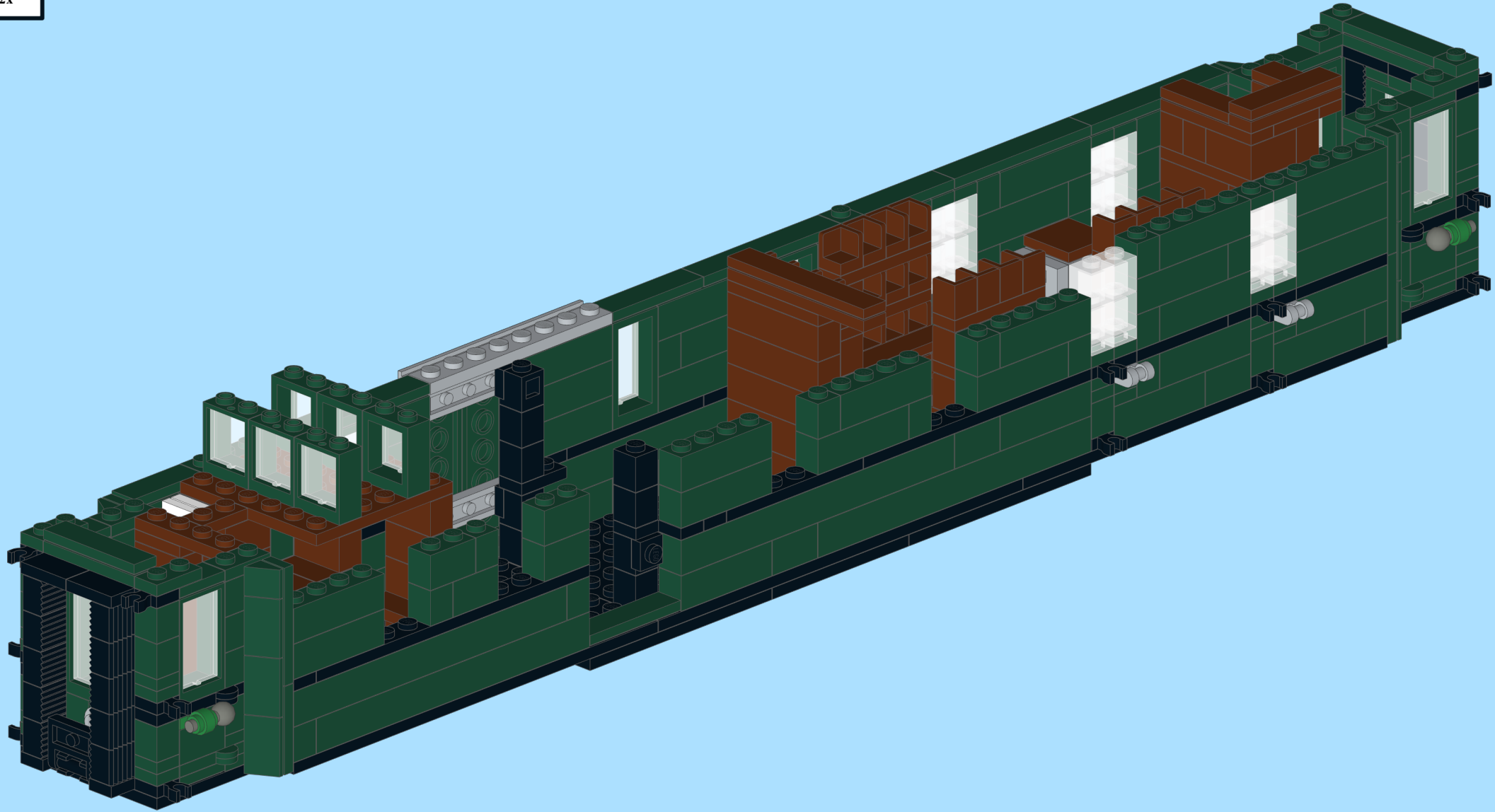
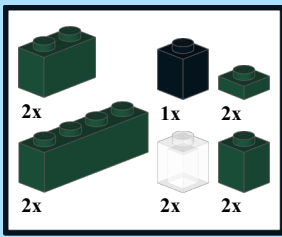

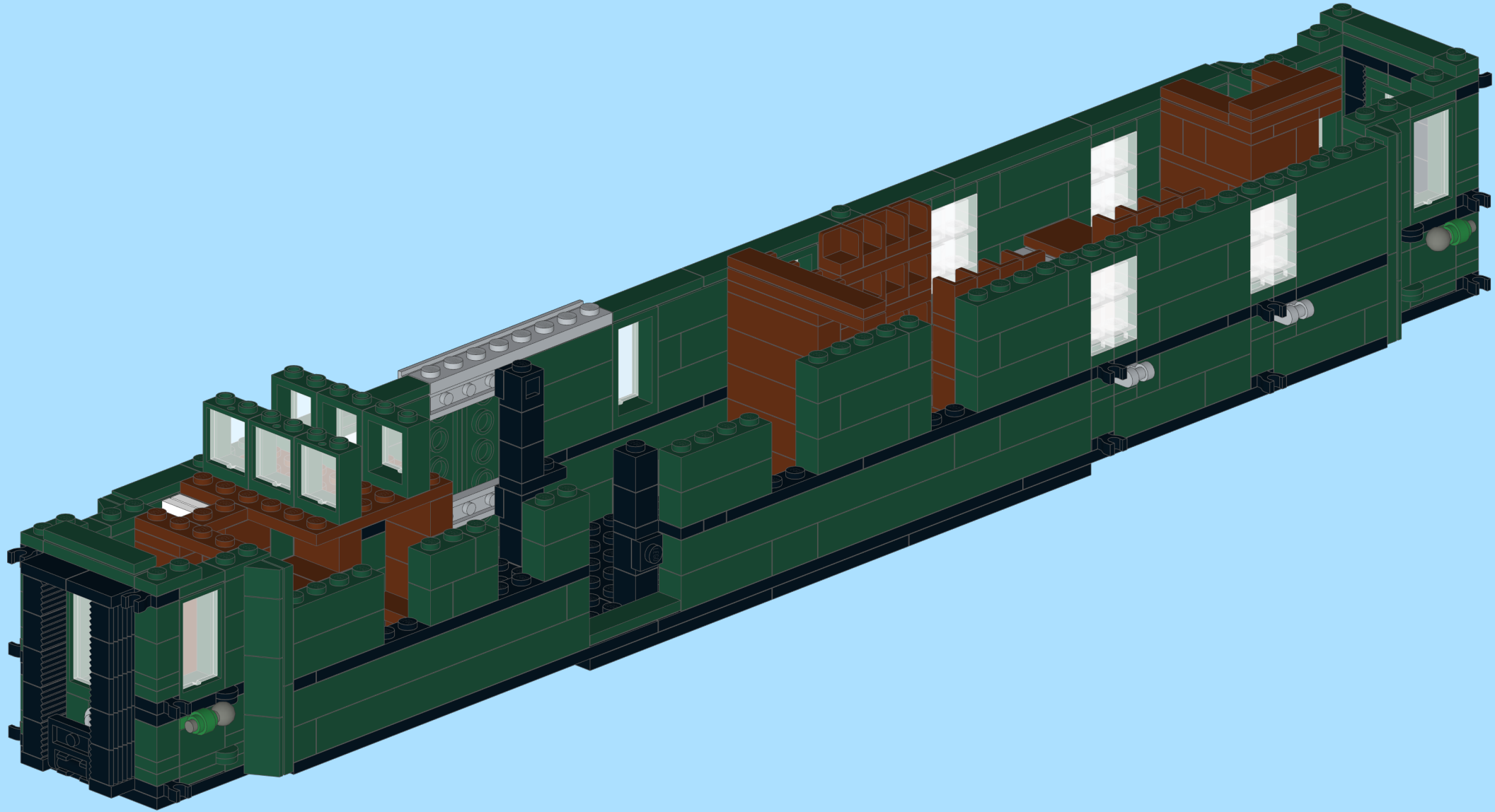
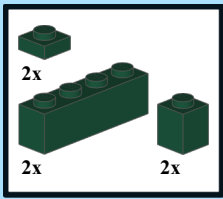

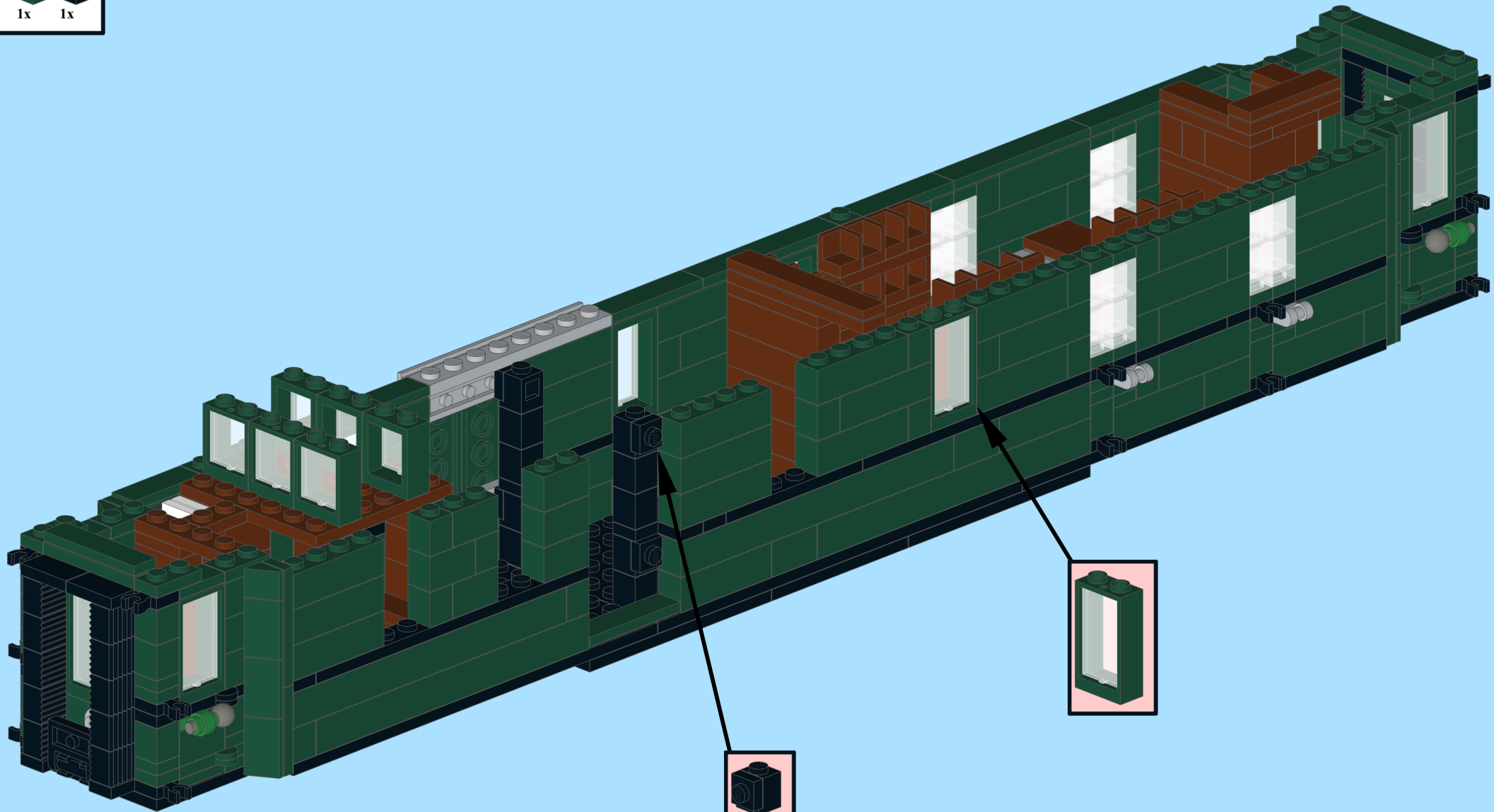
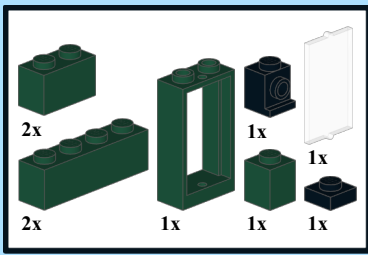

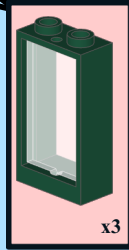
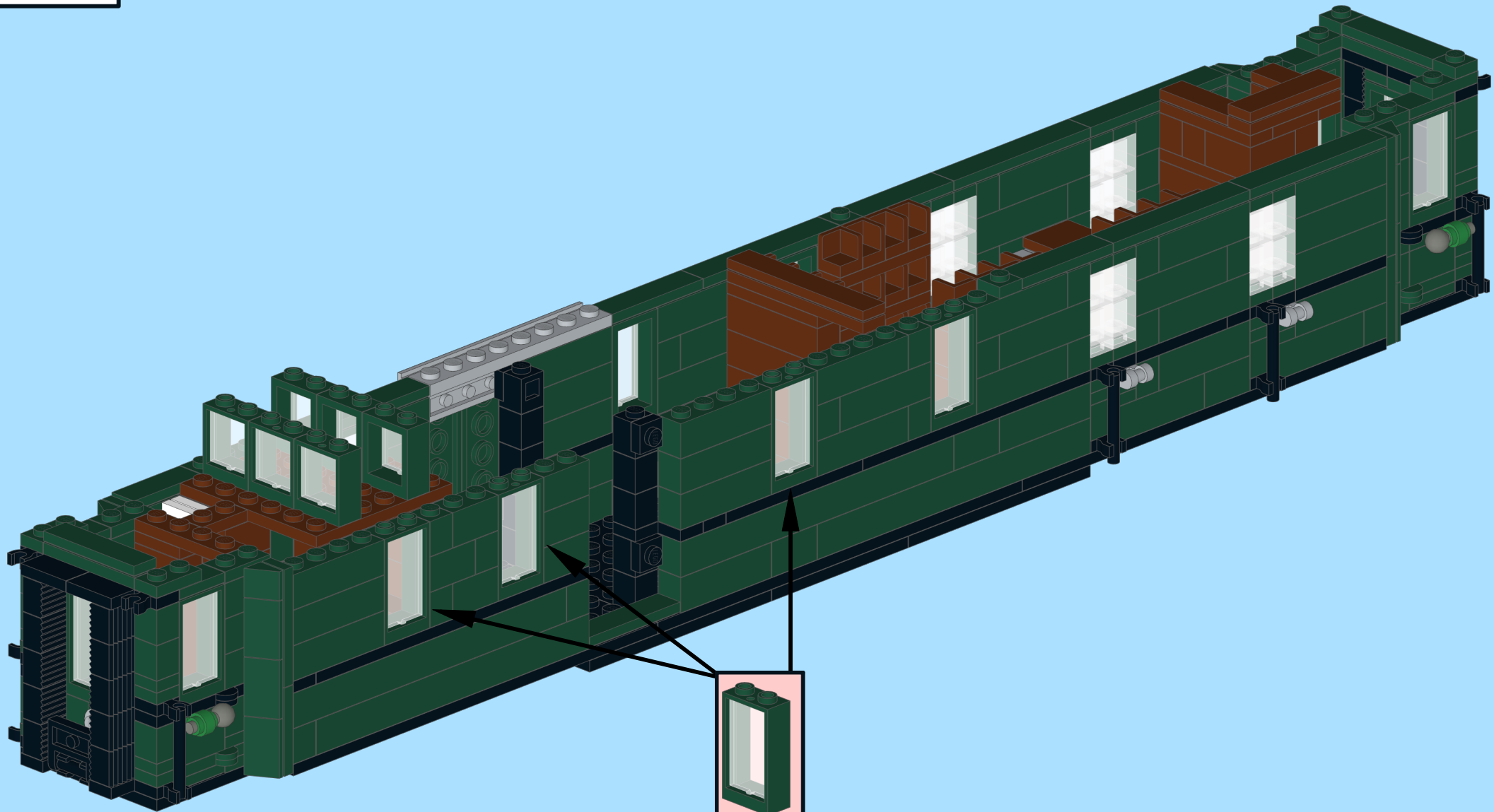
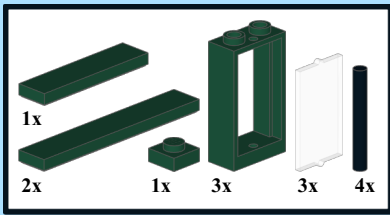

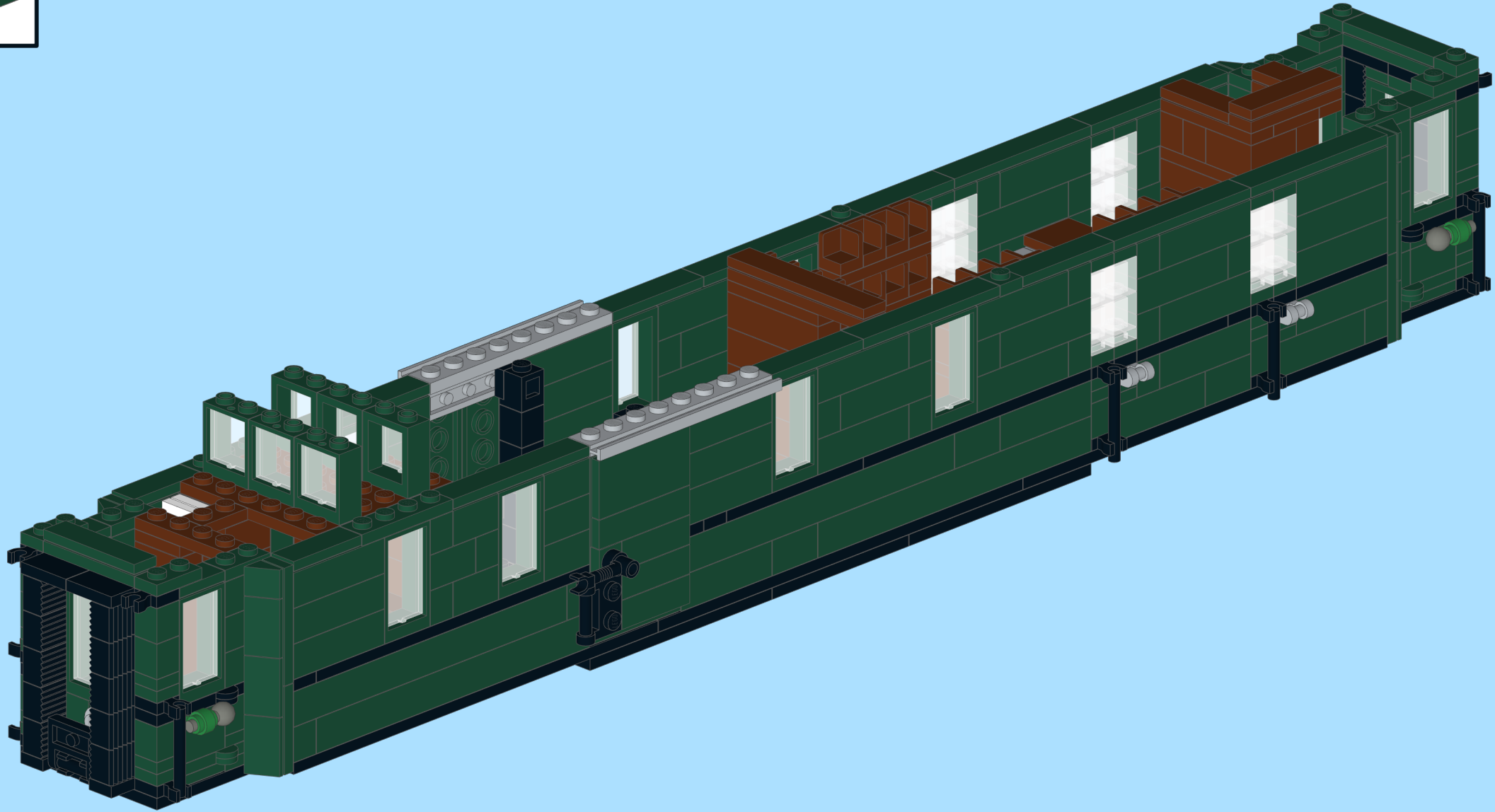
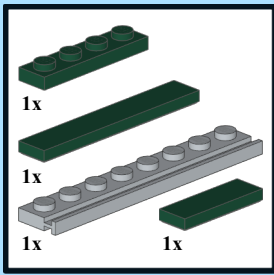

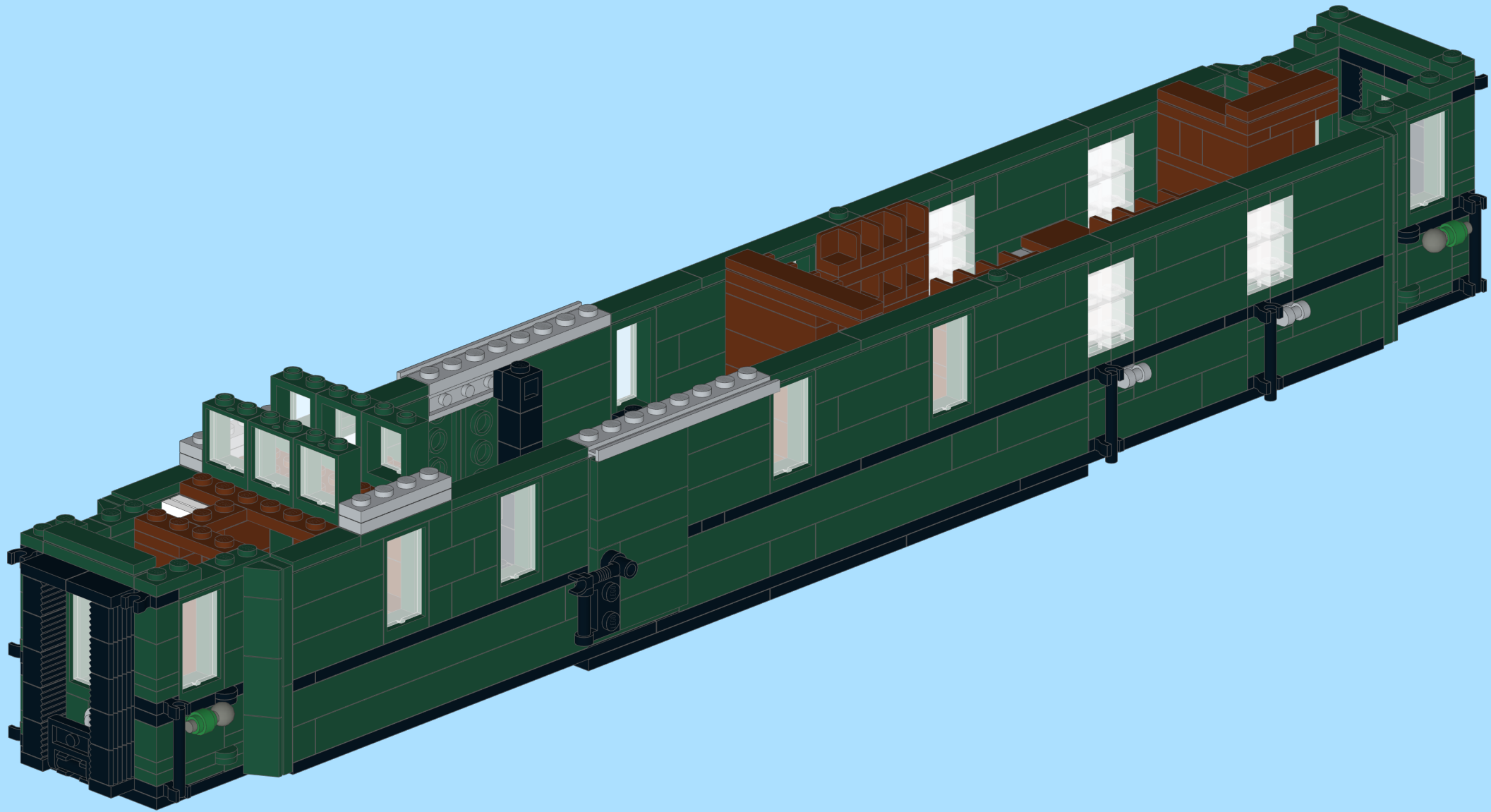
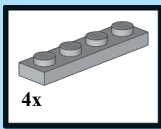

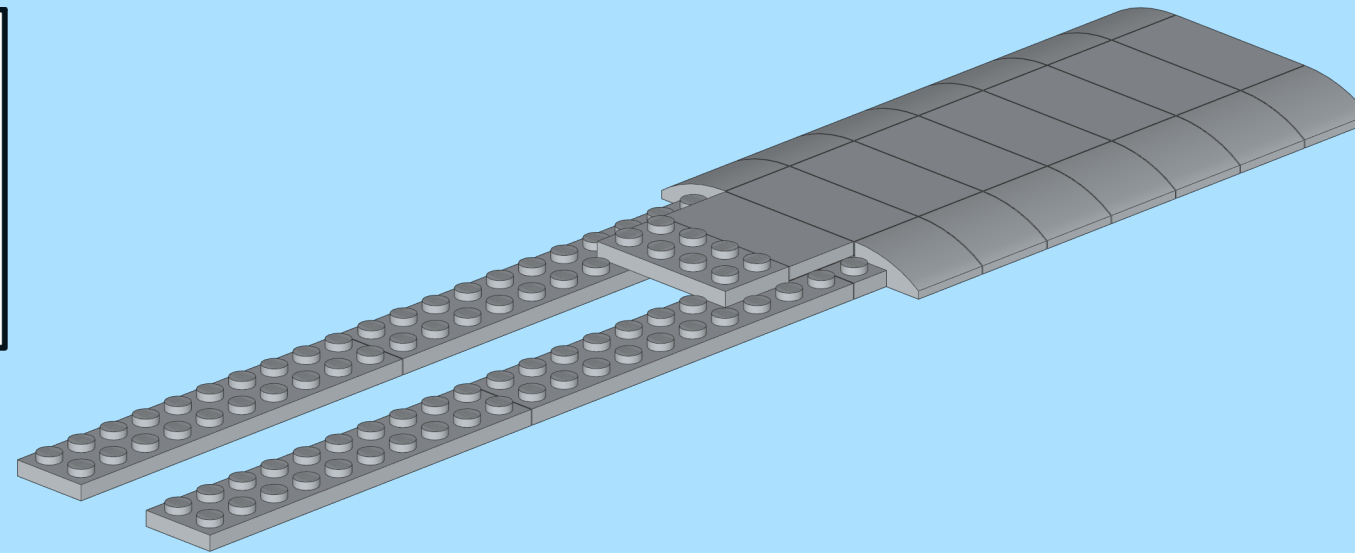
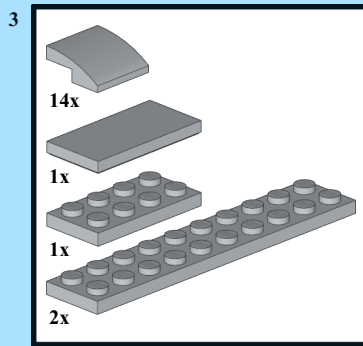
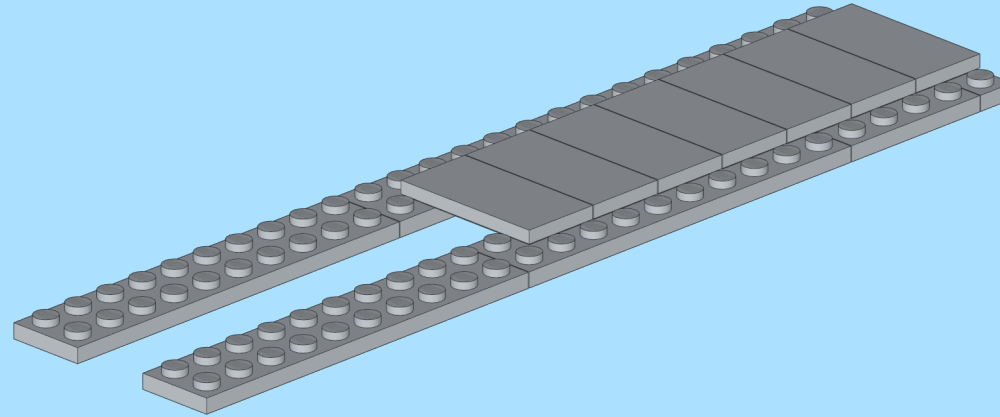
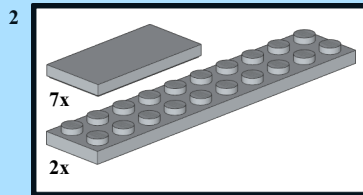
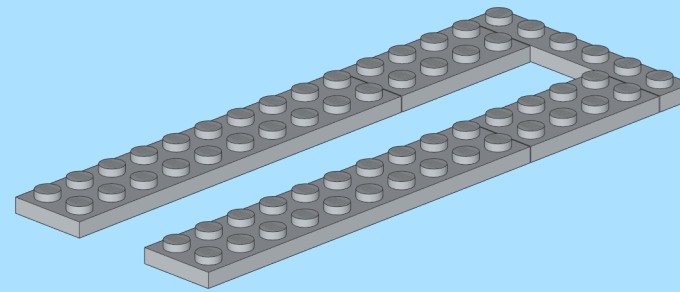
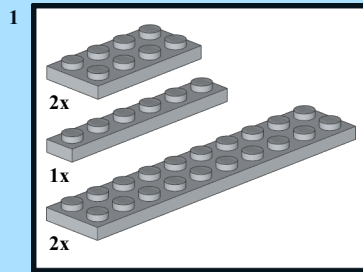

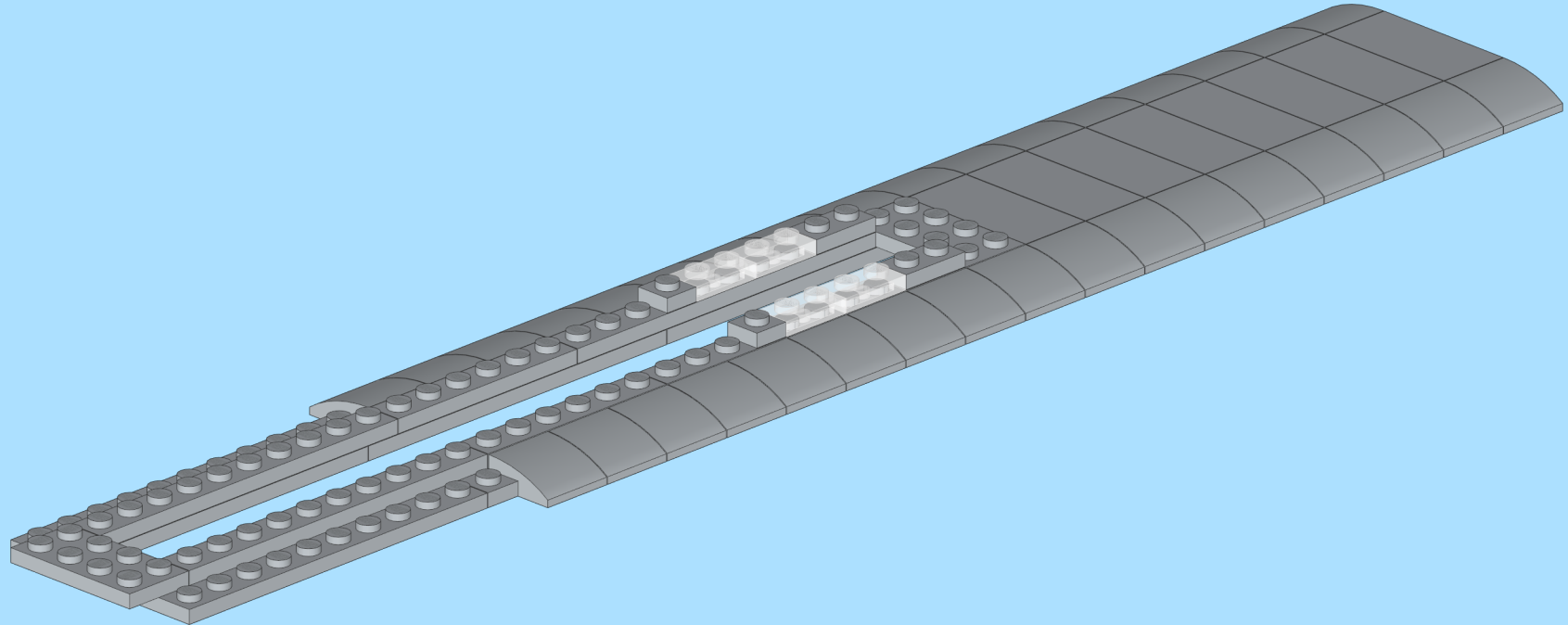
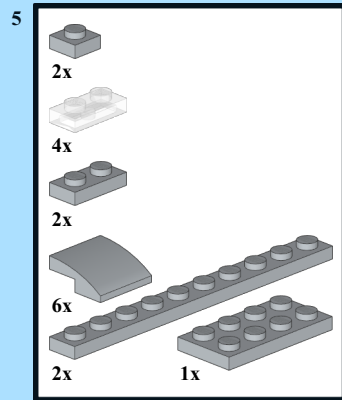
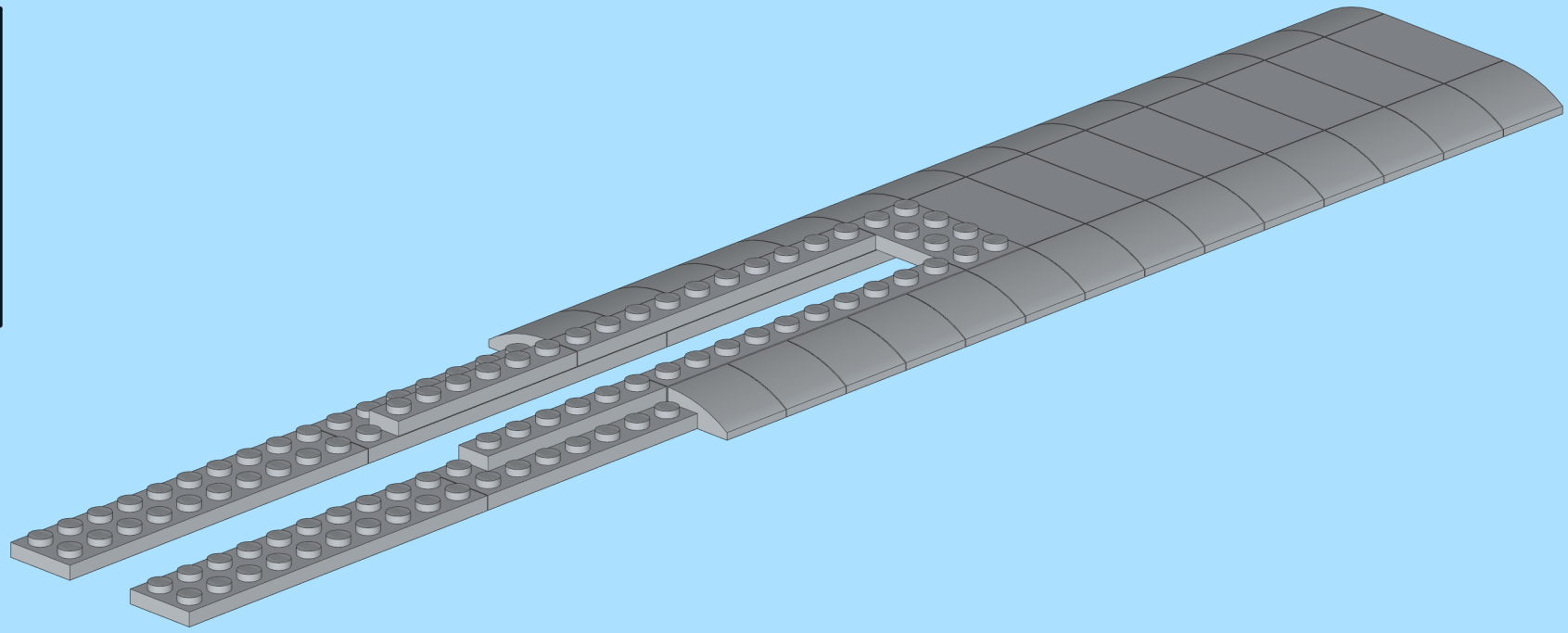
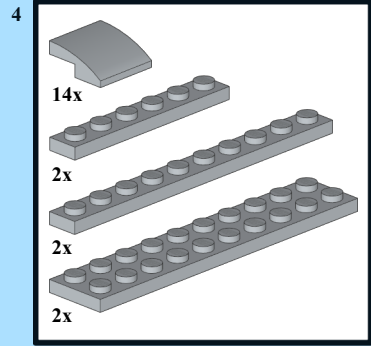

6

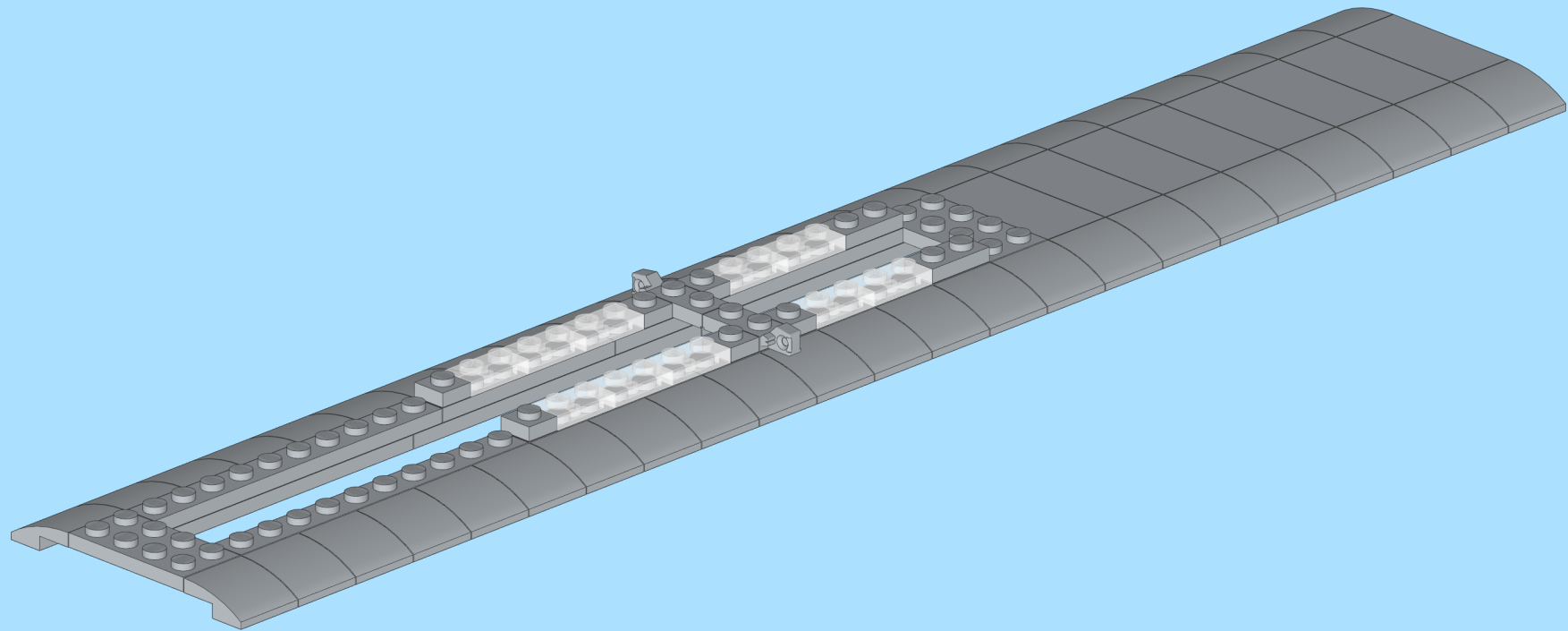
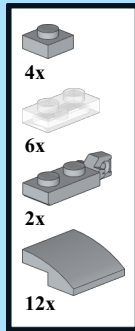

7

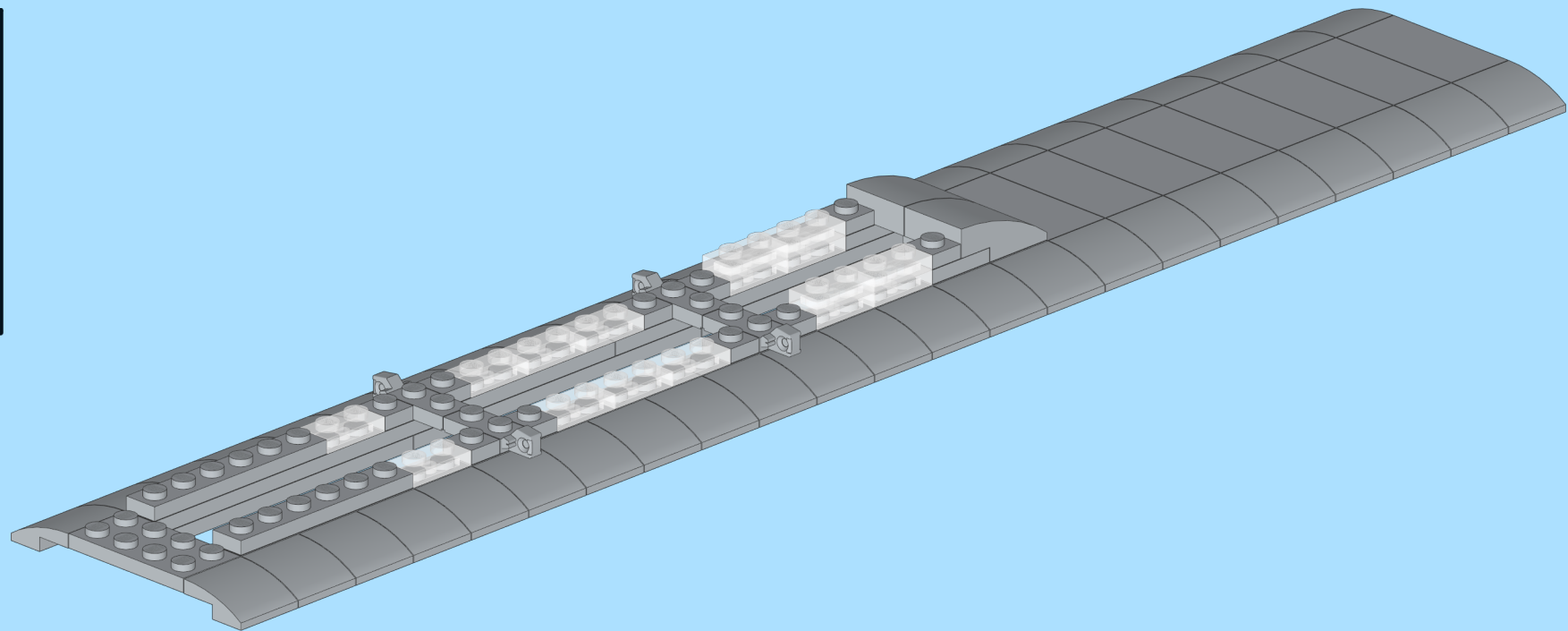
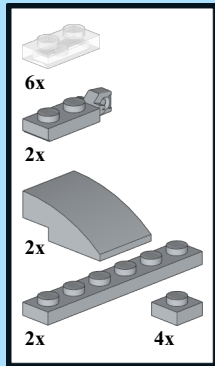

8

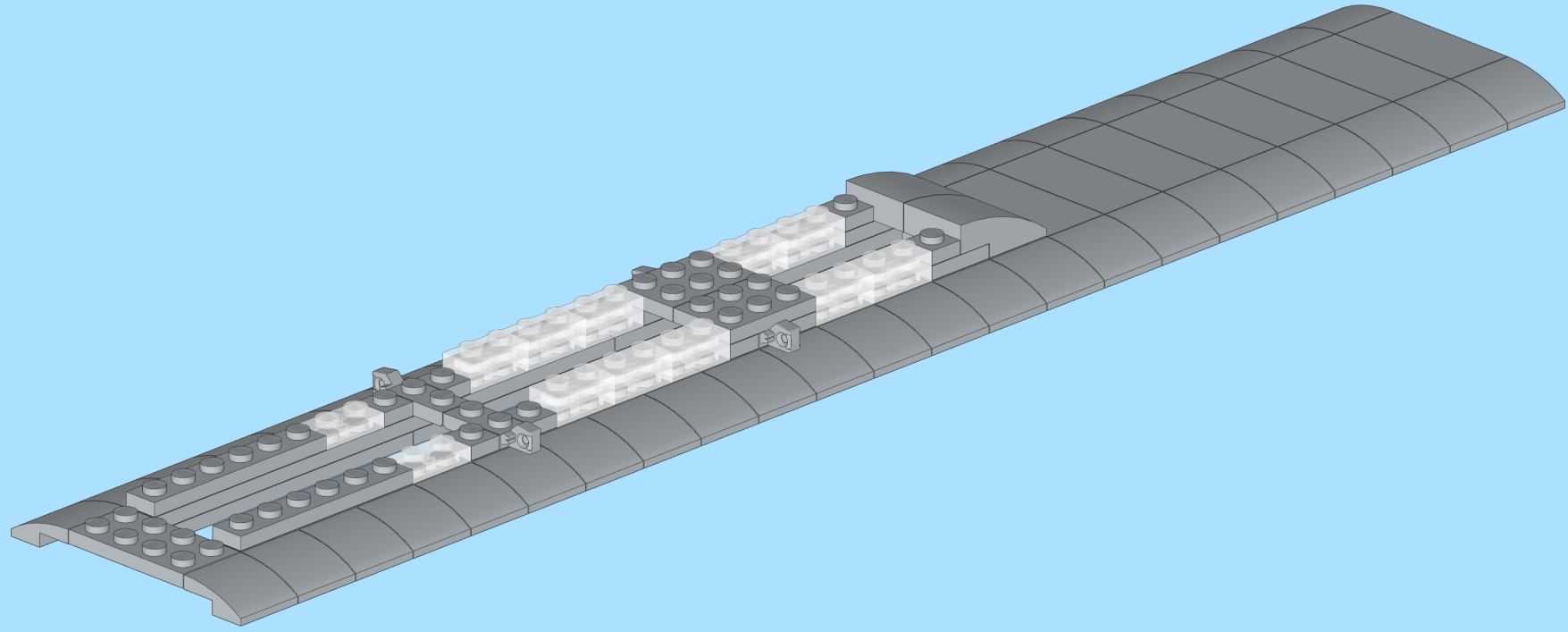
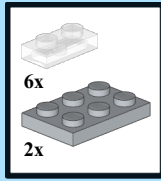

9

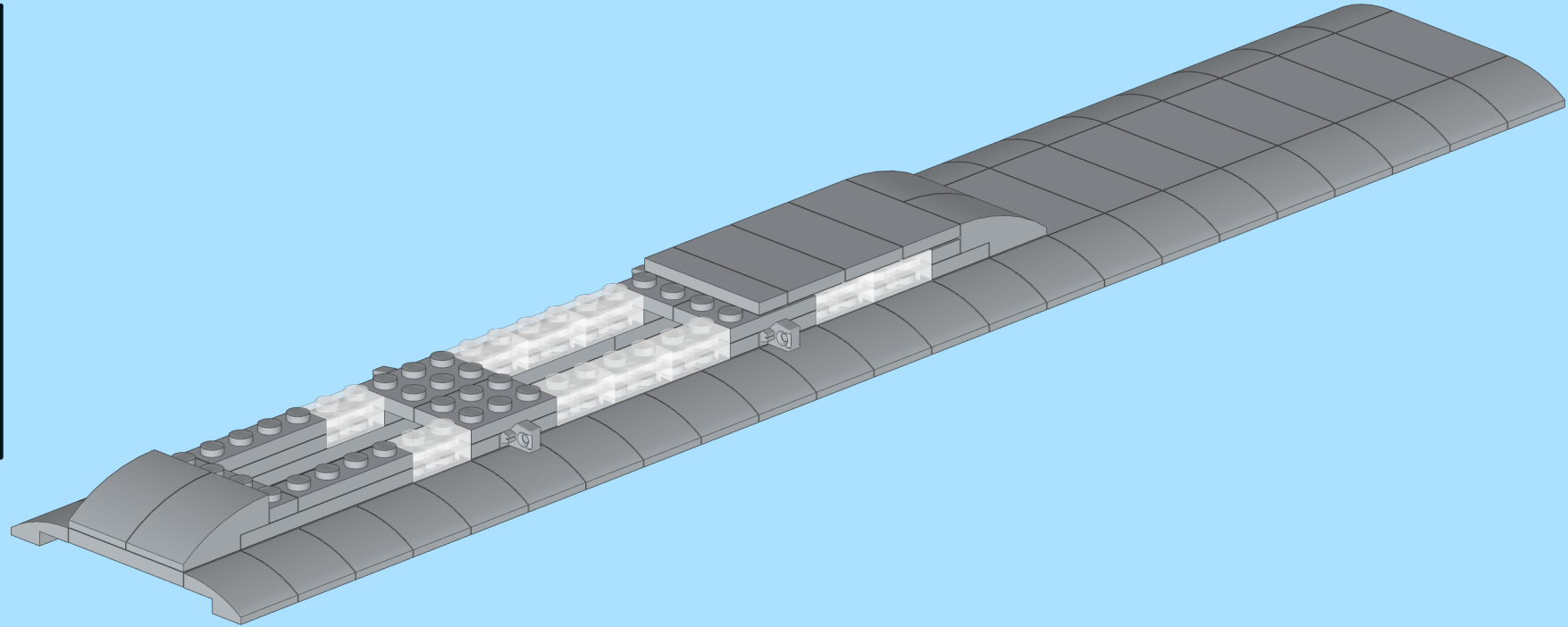
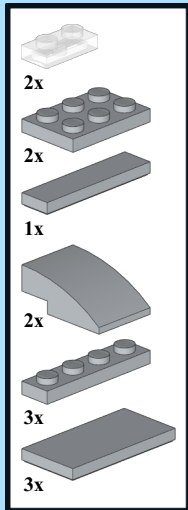

10

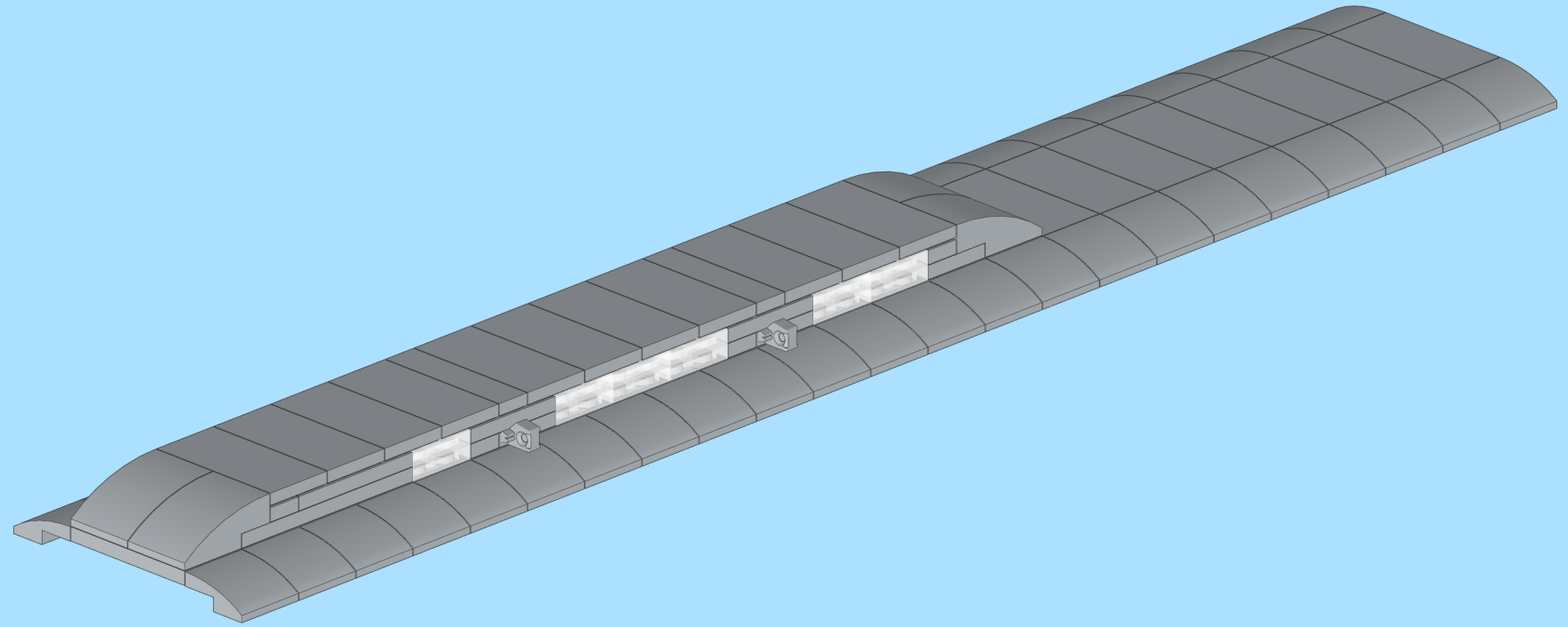
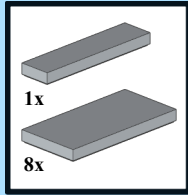

11

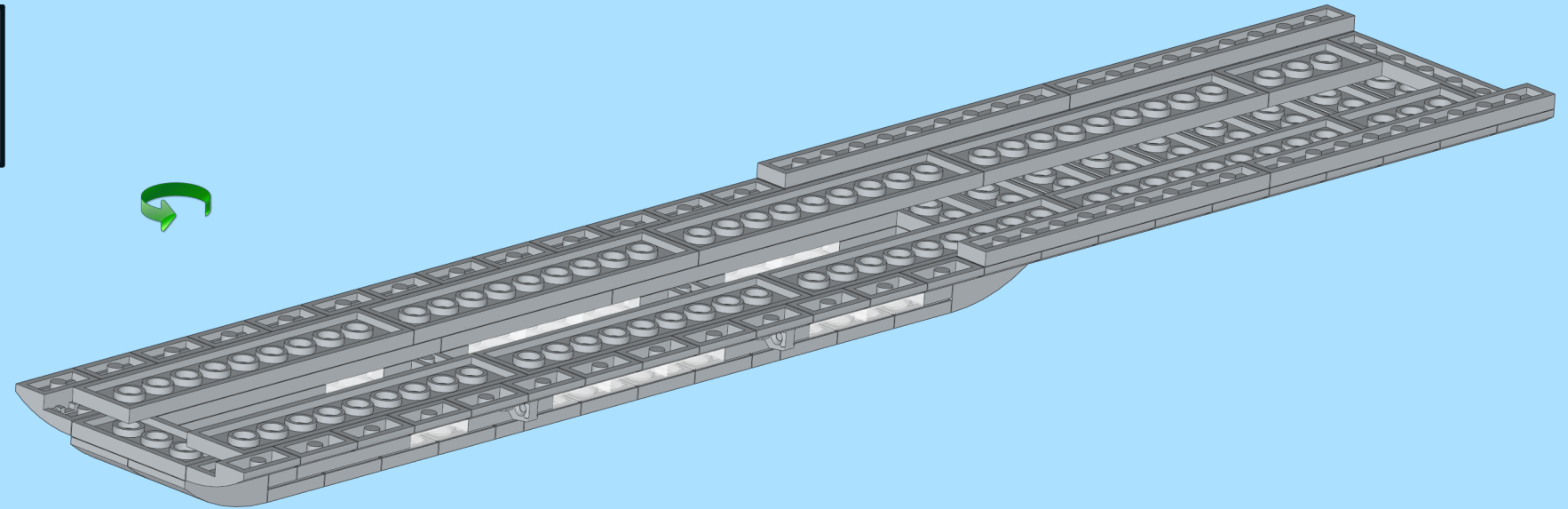
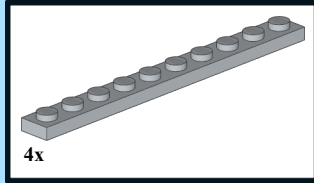

12

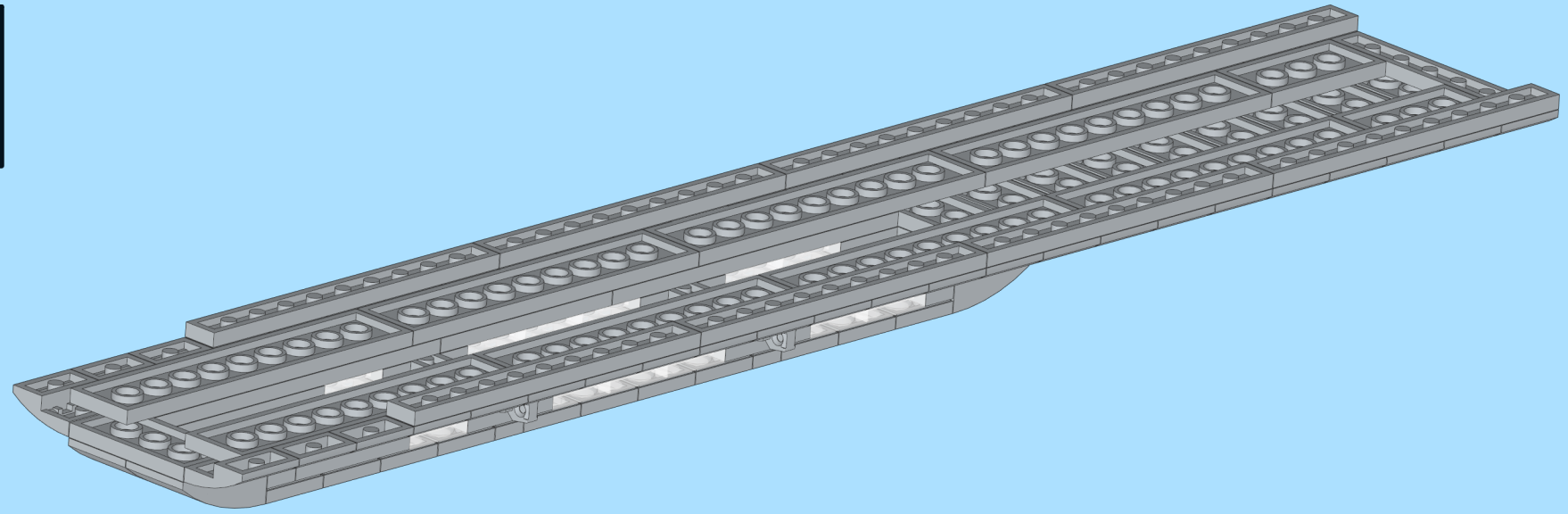
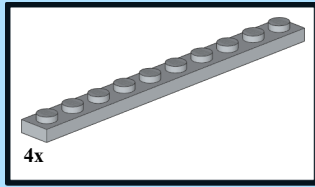

13

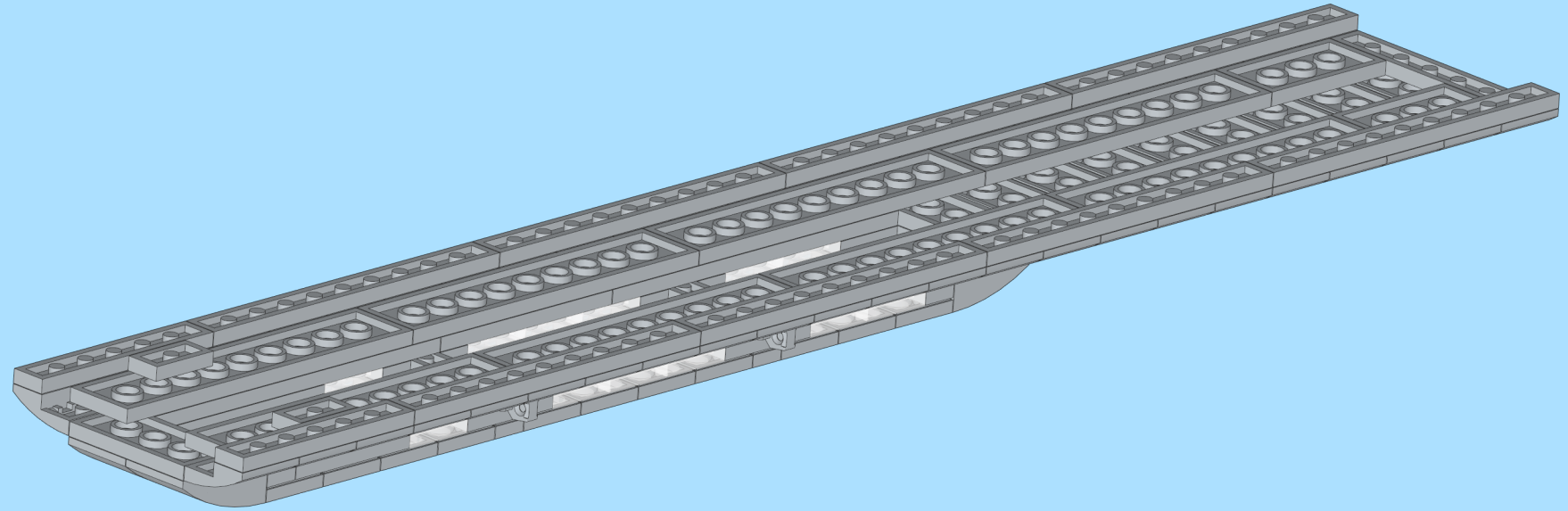
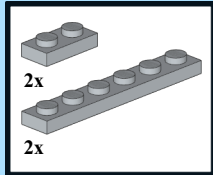

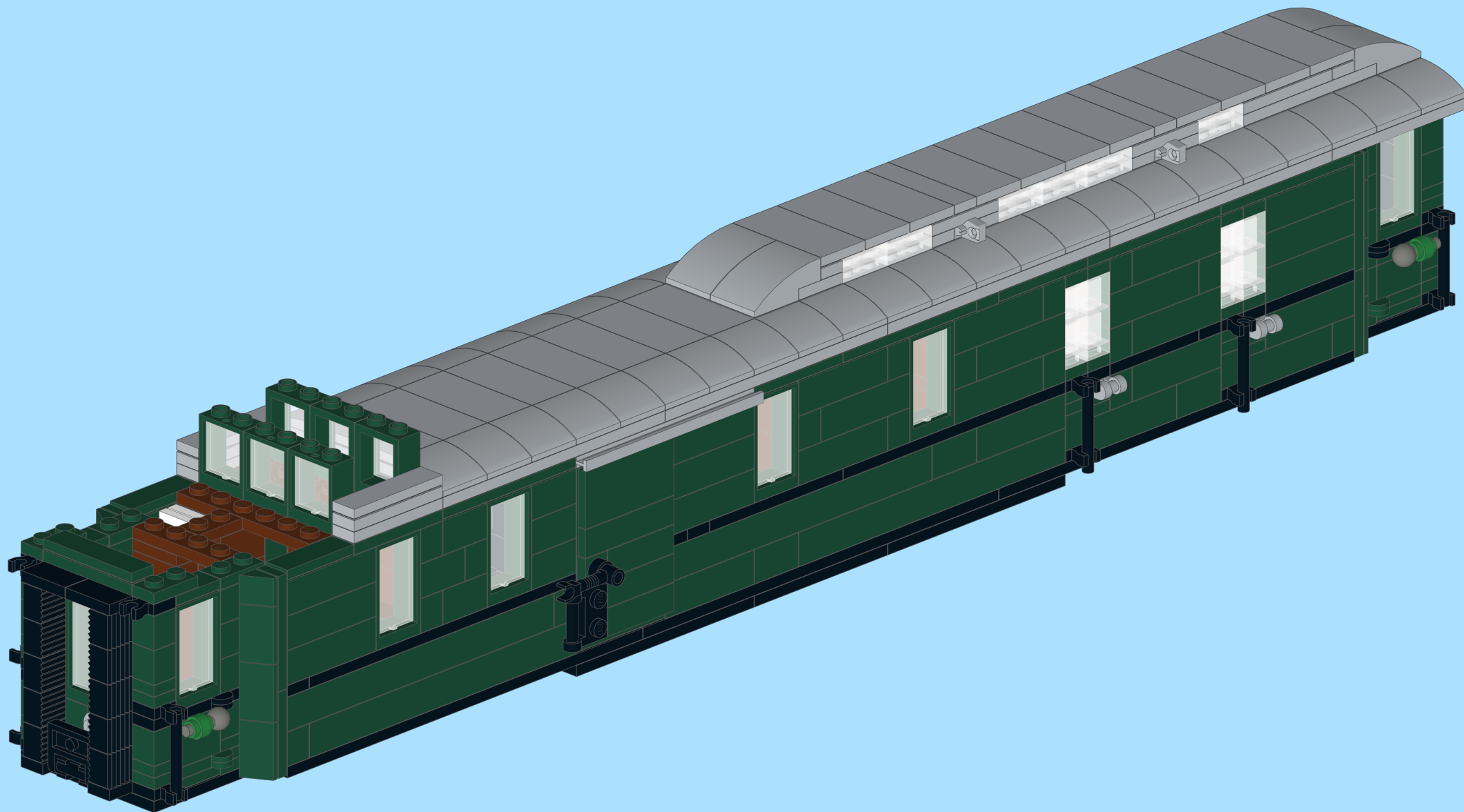
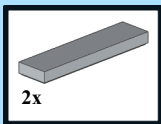

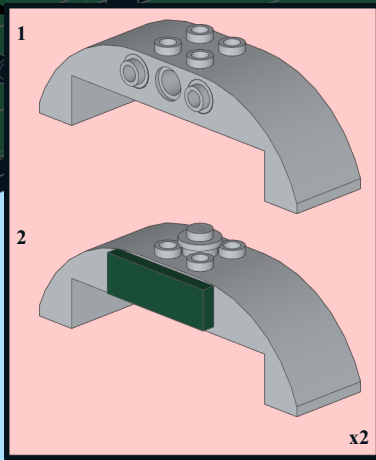
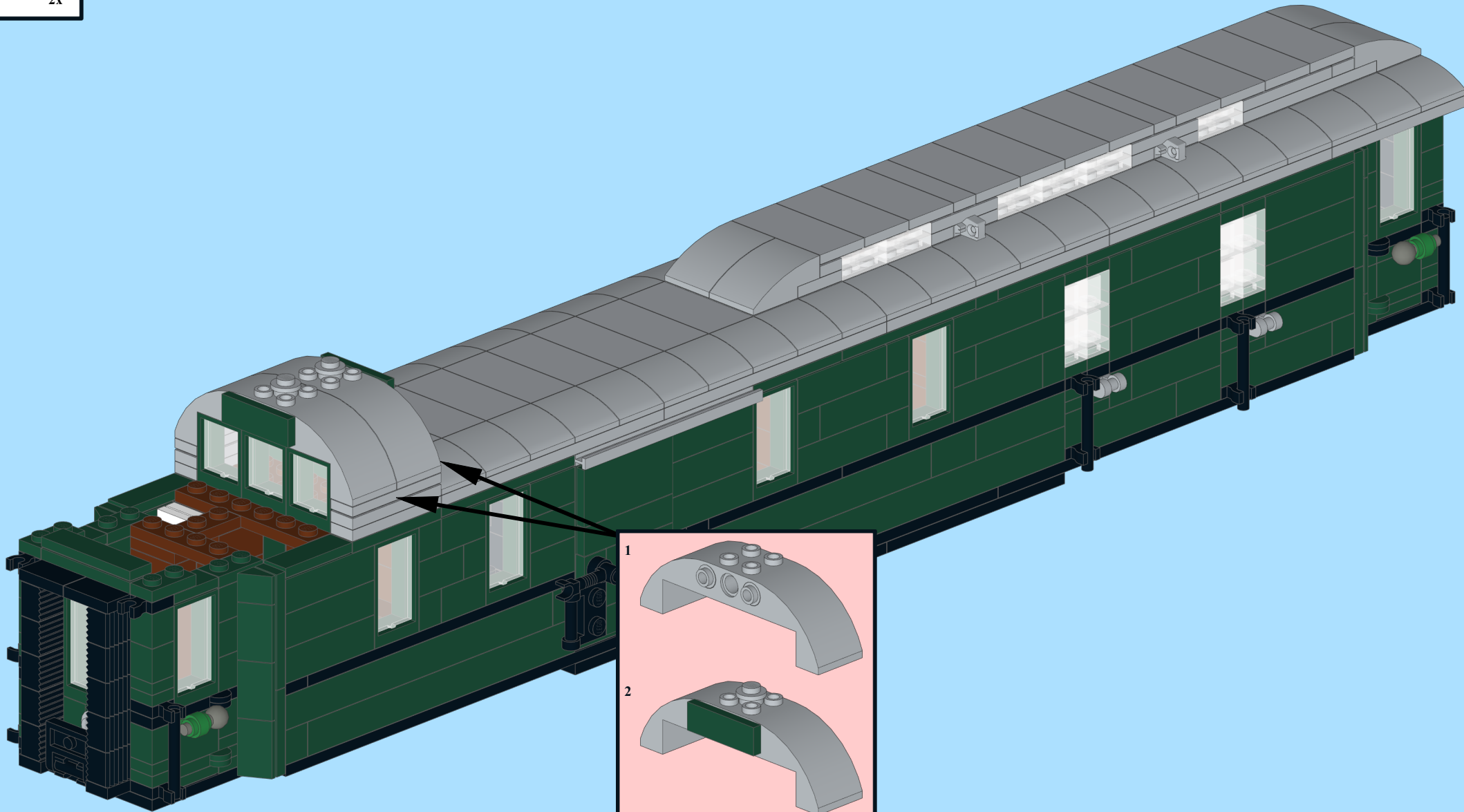
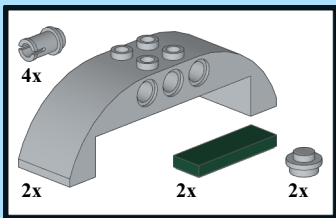

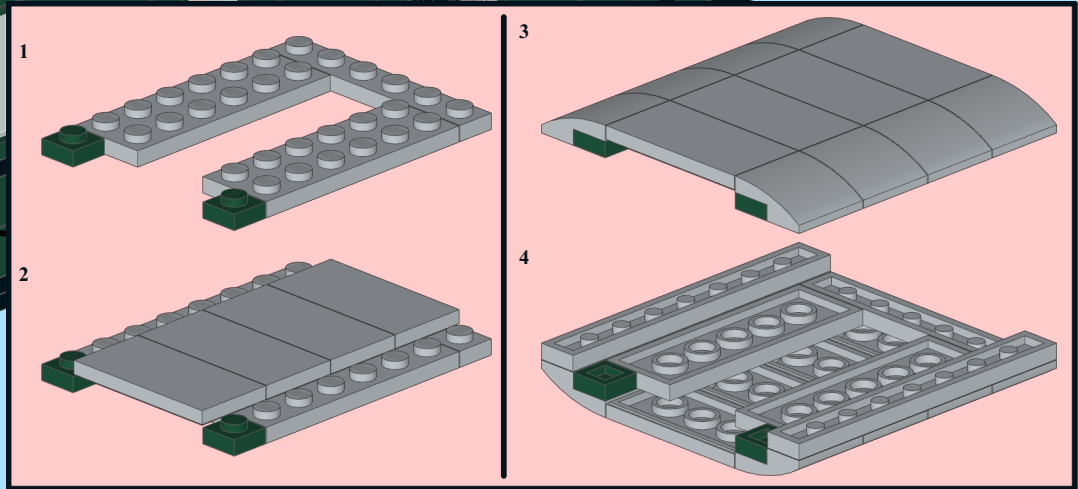
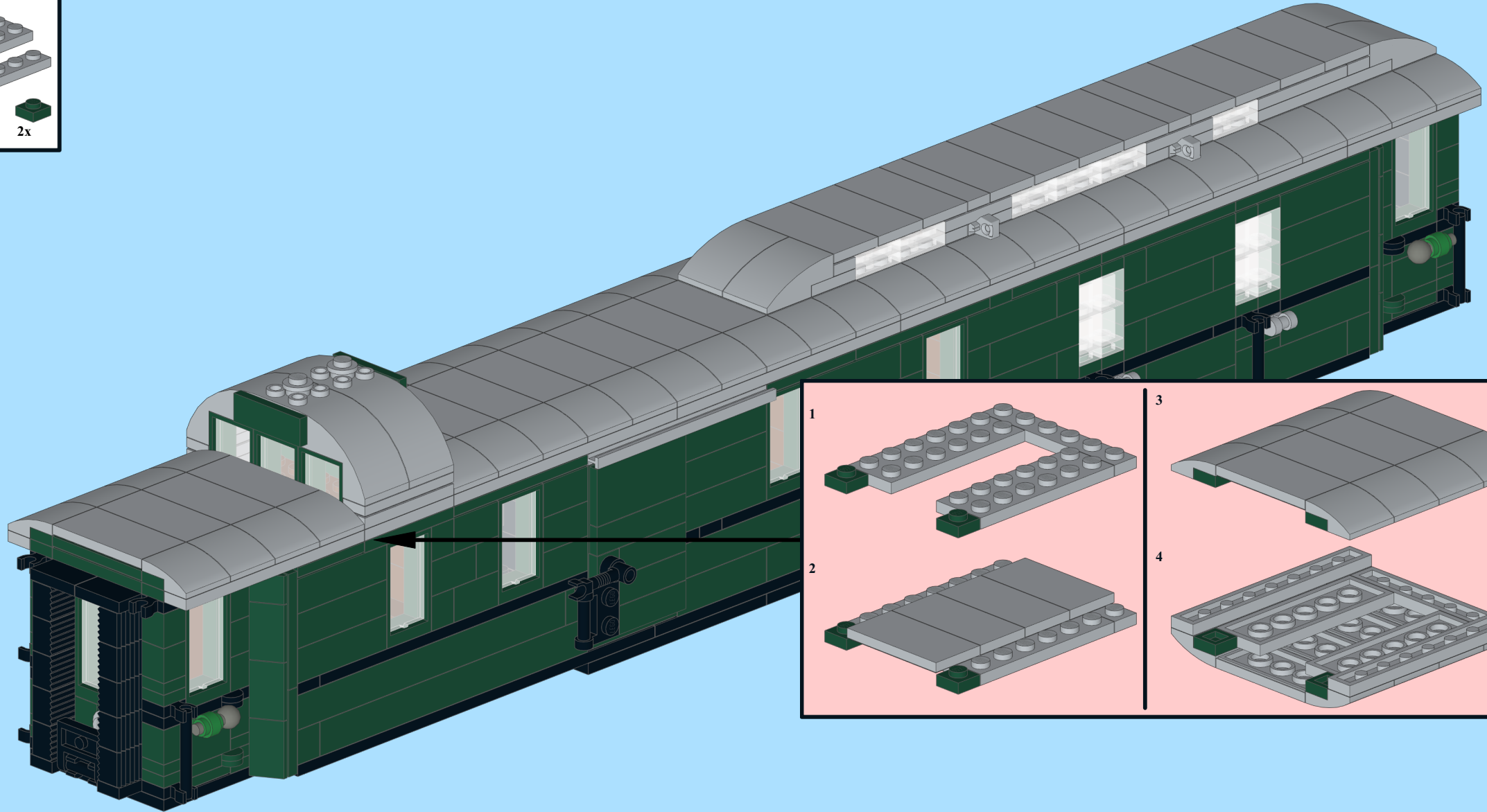
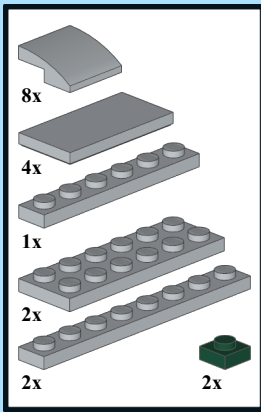

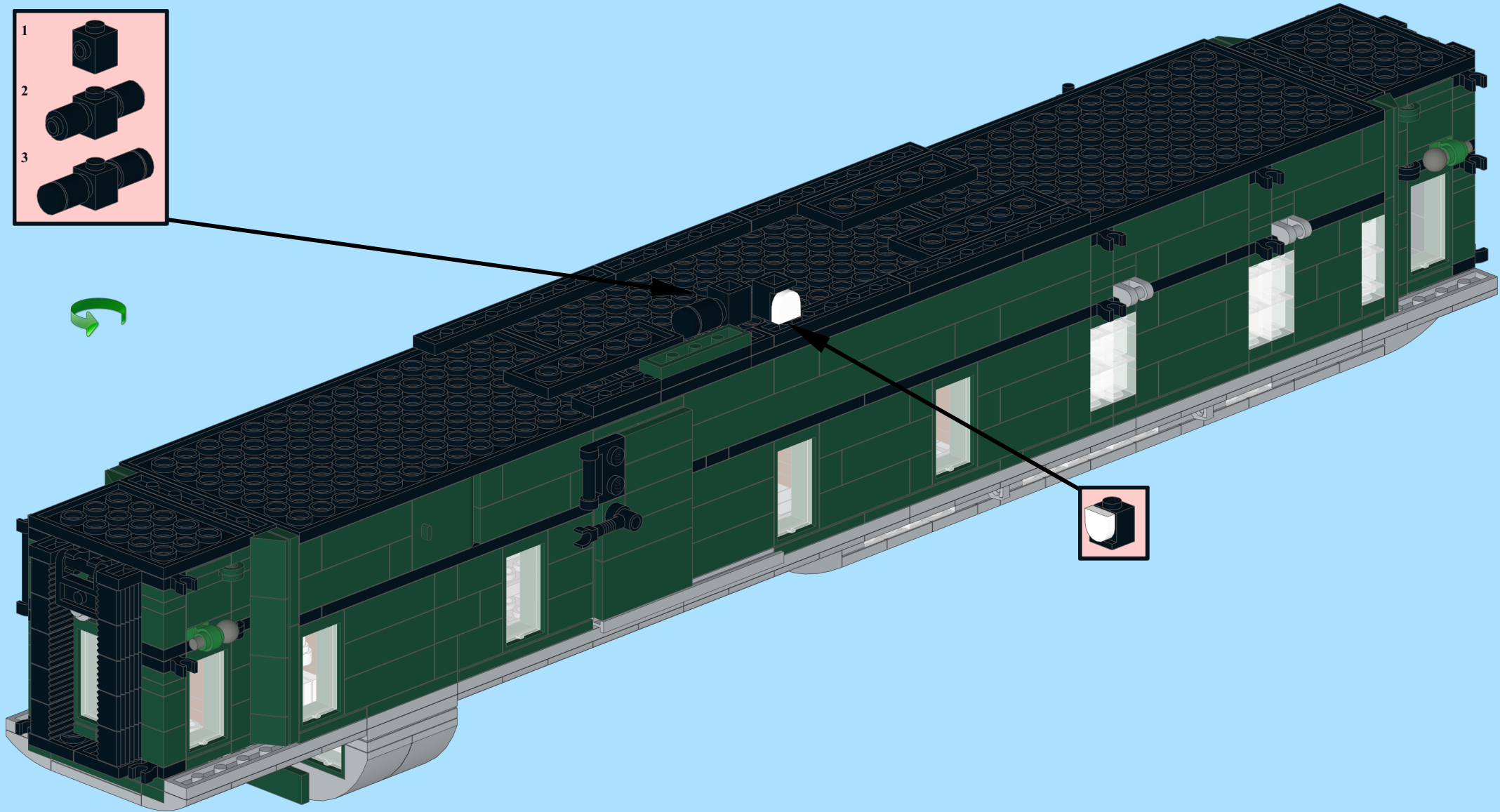
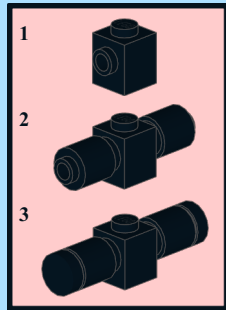
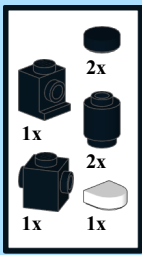

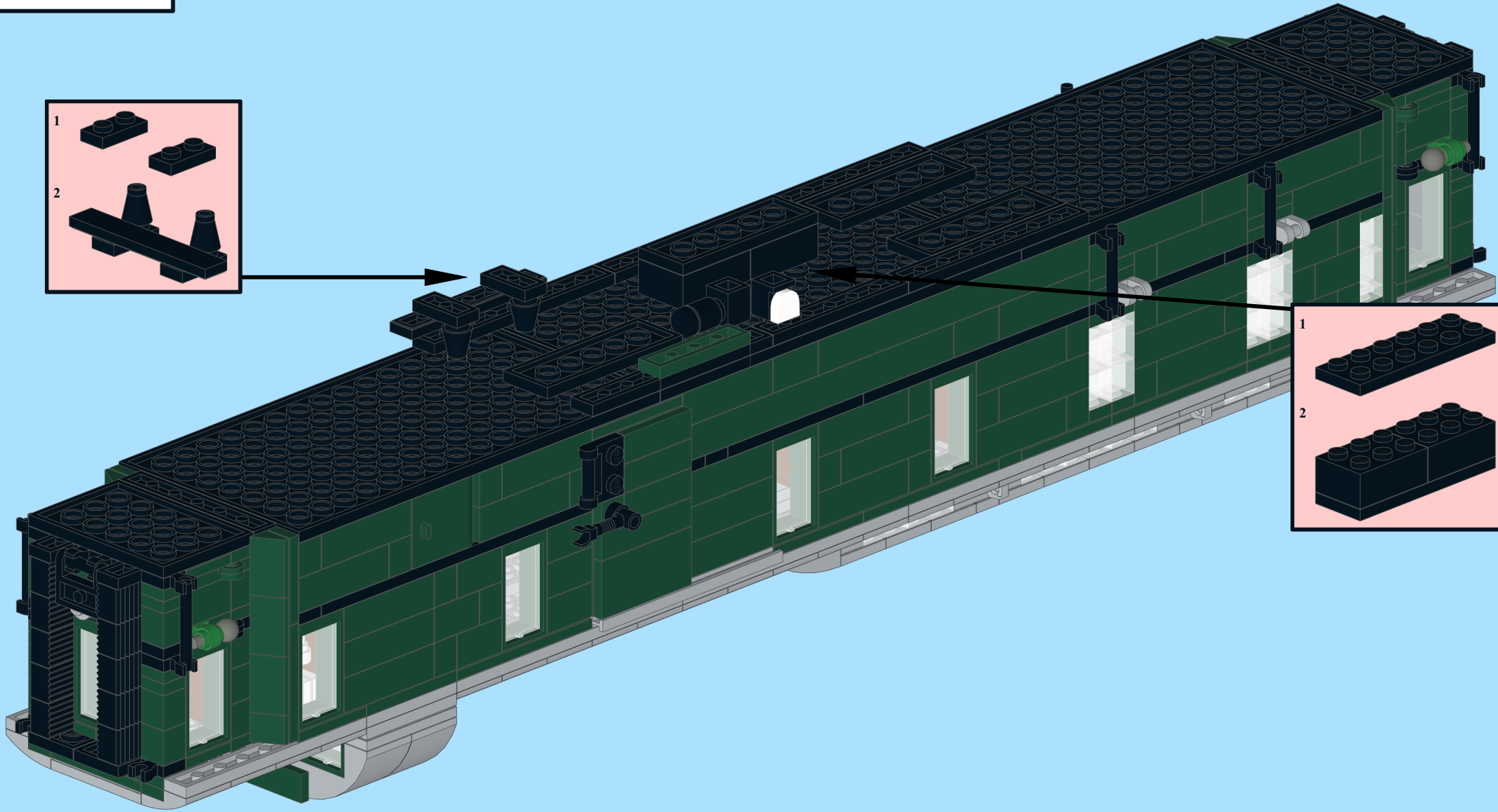
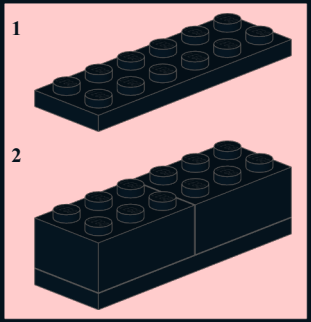
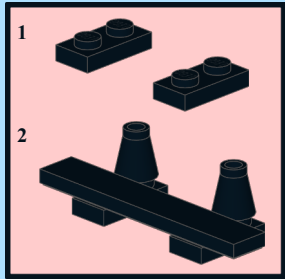
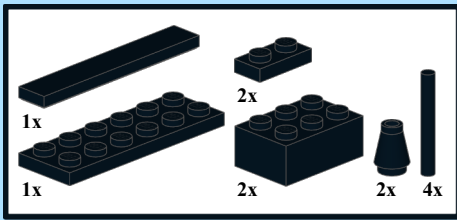

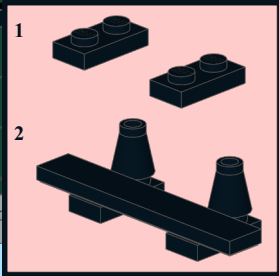
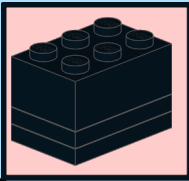
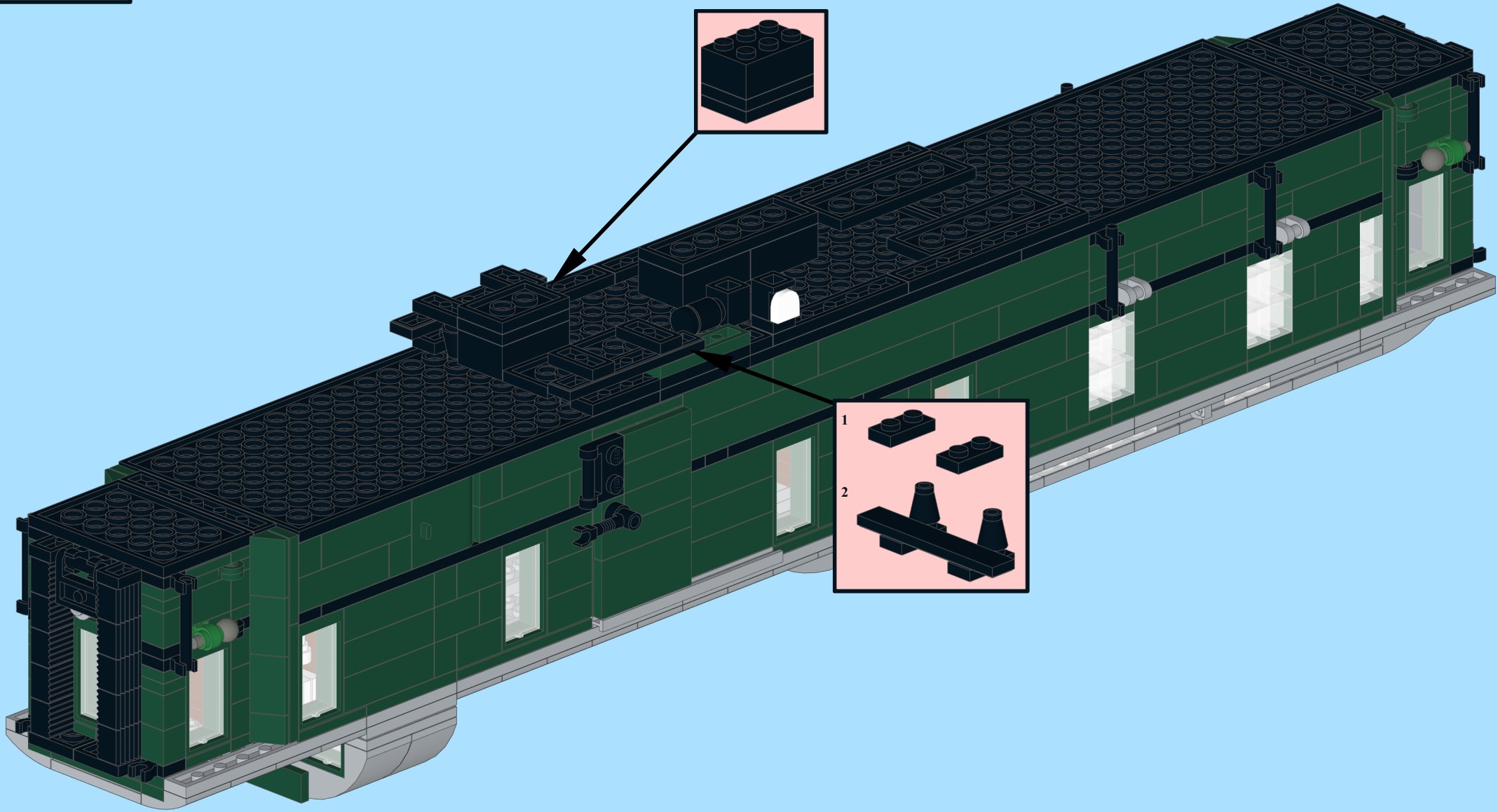
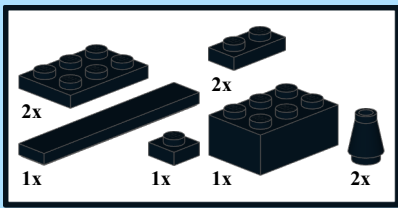

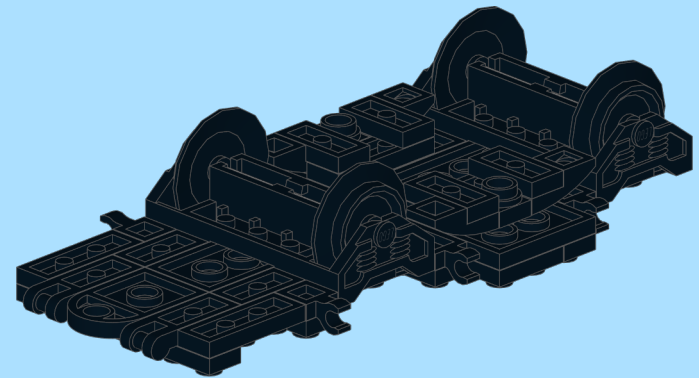
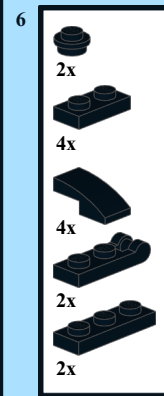
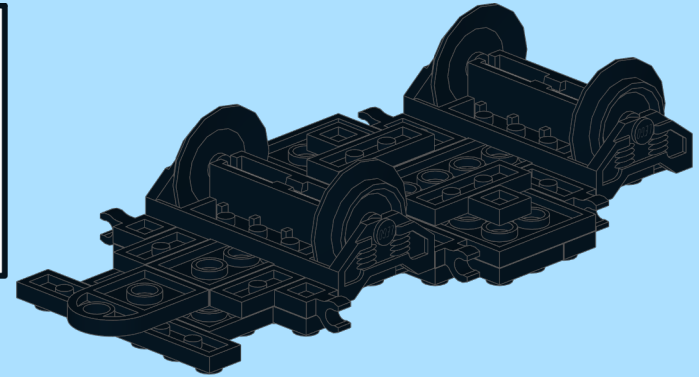
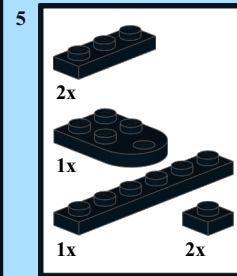
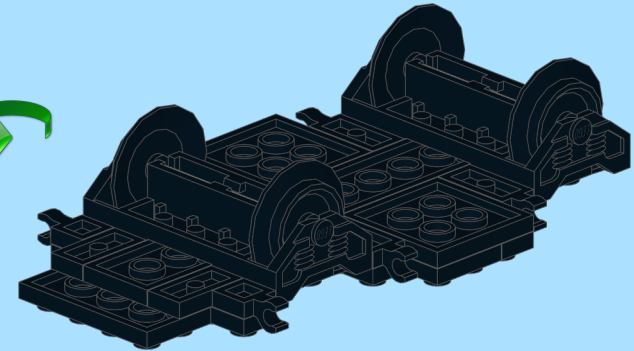
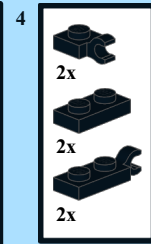
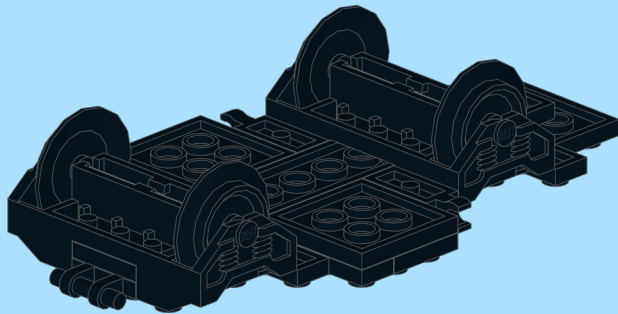
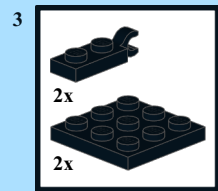
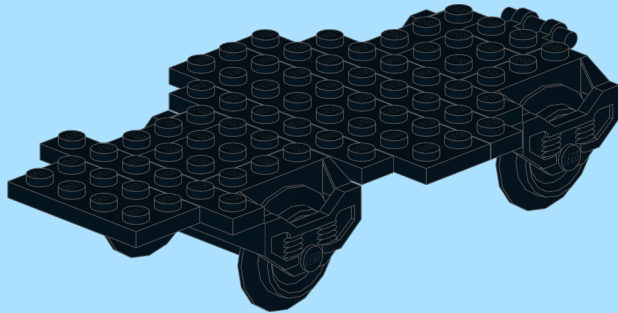
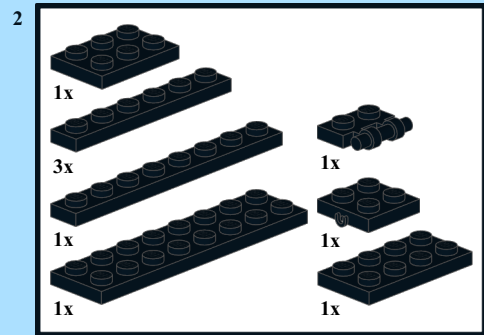
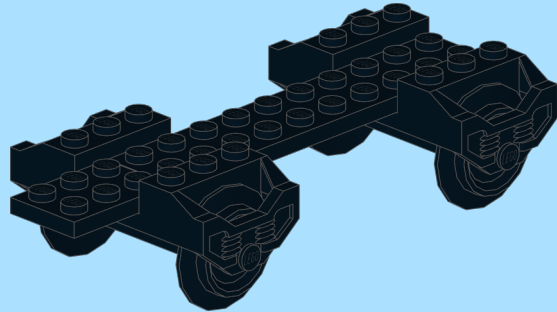
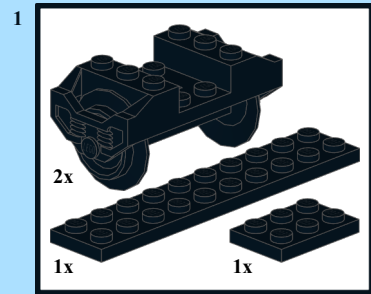

7

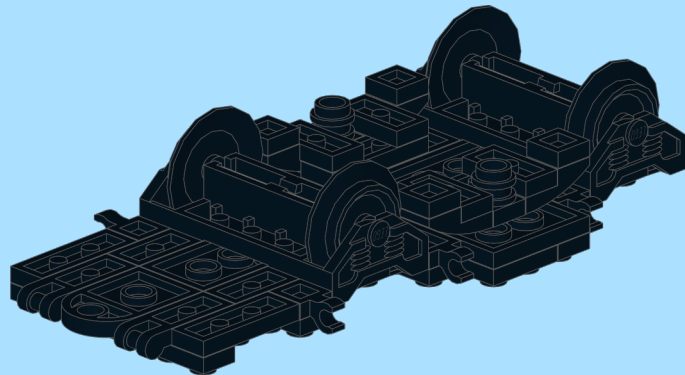

8

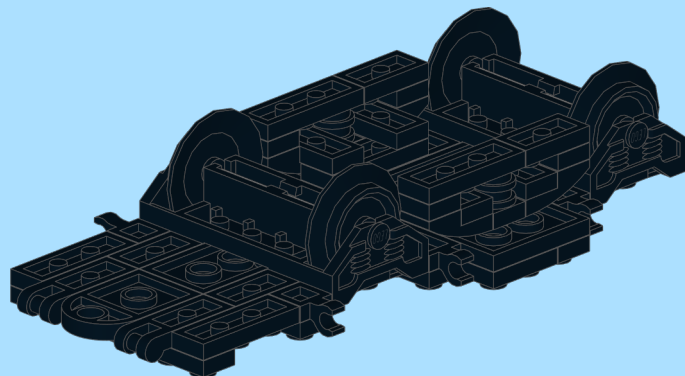
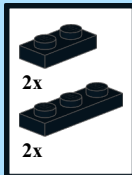

9

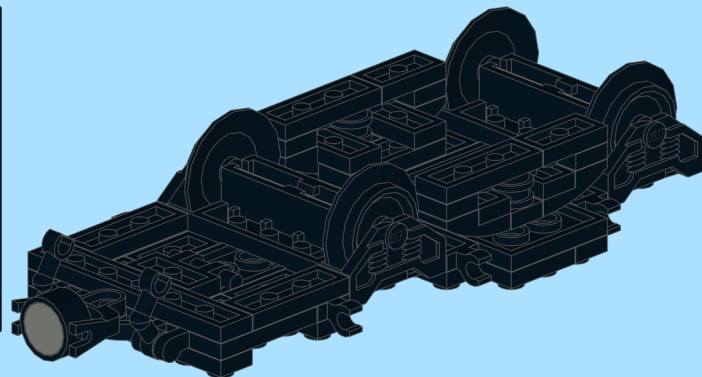
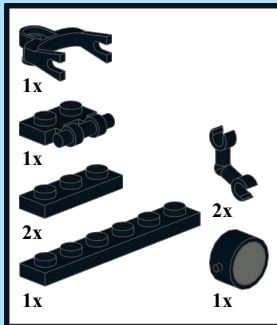

10

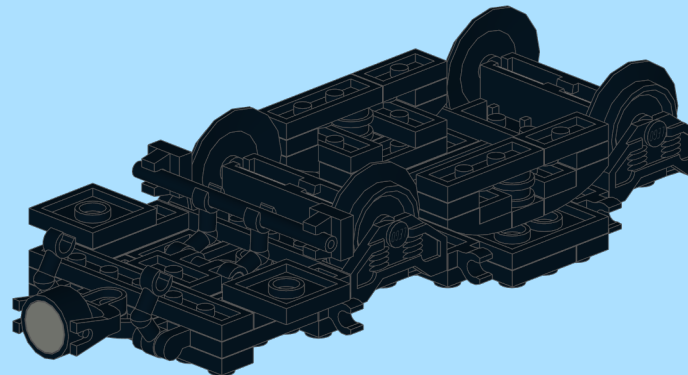
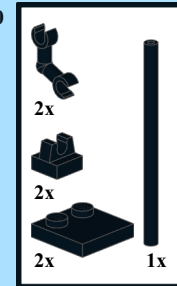

11

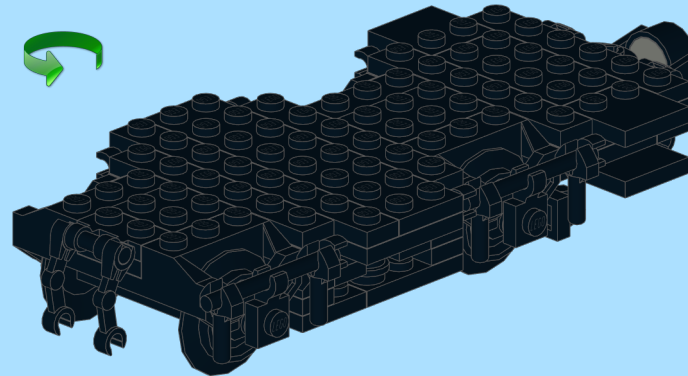
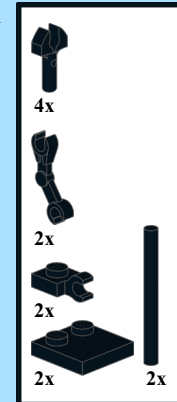

12

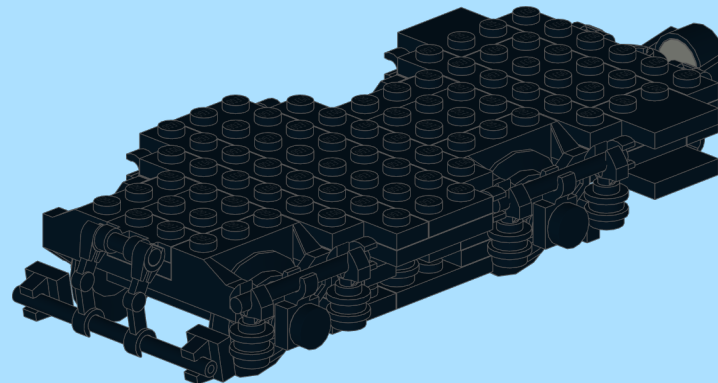
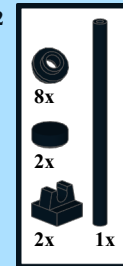

13

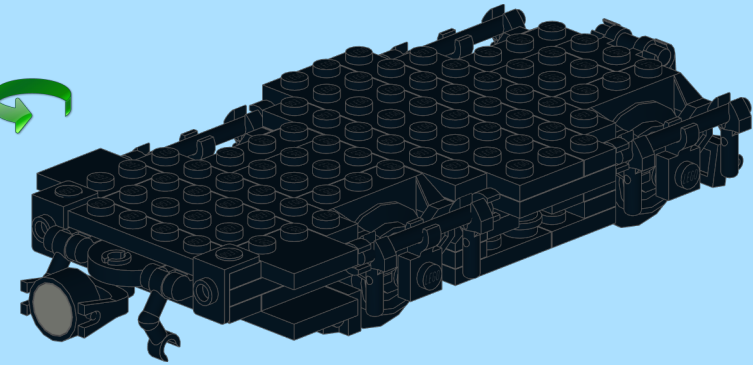
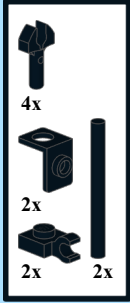

14

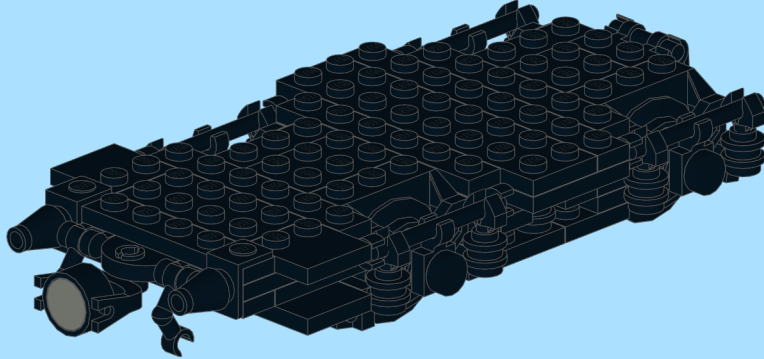

15

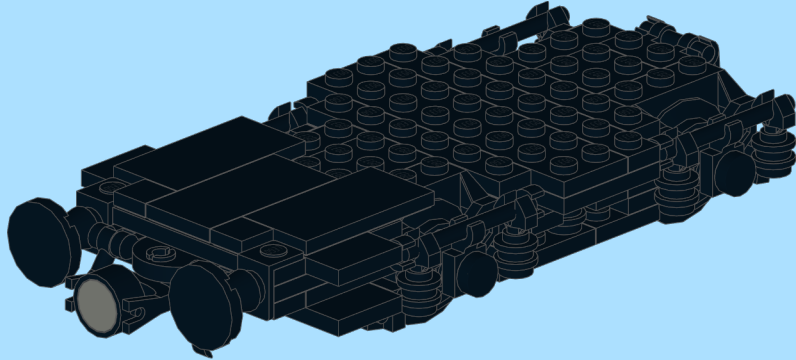
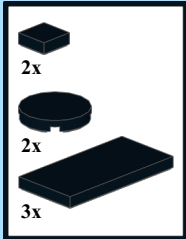

16

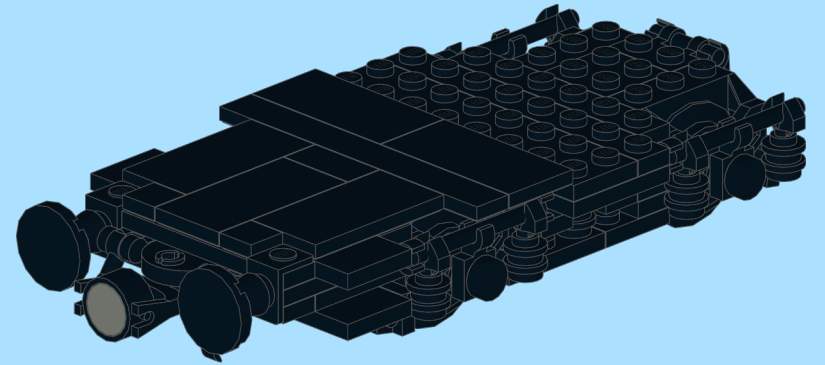
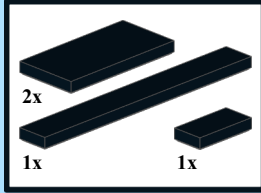

17

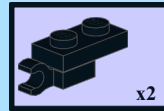
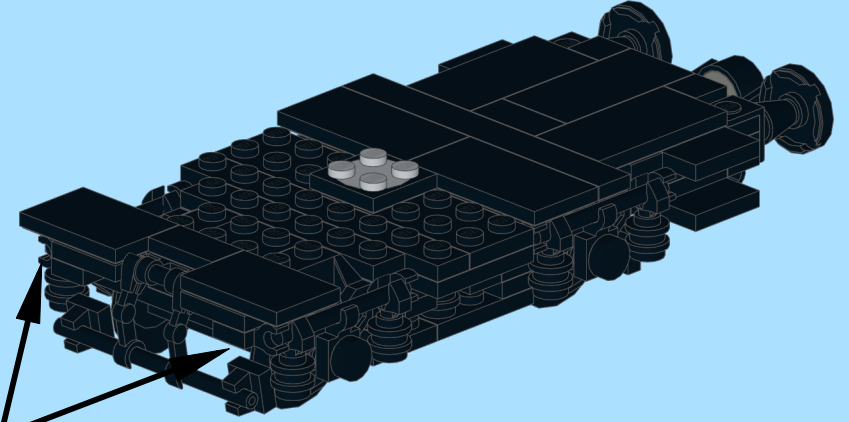
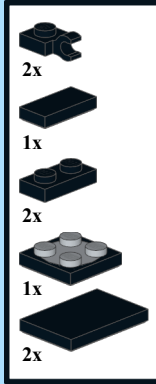

18

