

Olsen Banden

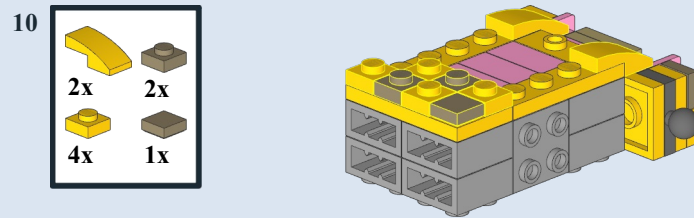

Design by: Hanne Lindberg

INSTRUCTION BY
KNUD ALBRECHTSEN
www.snakebyte.dk/lego

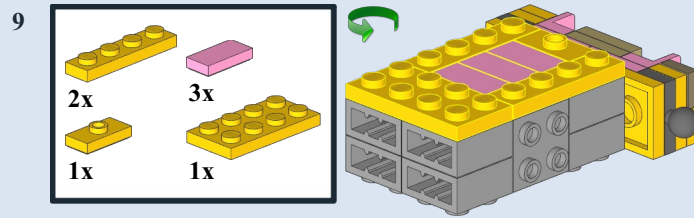
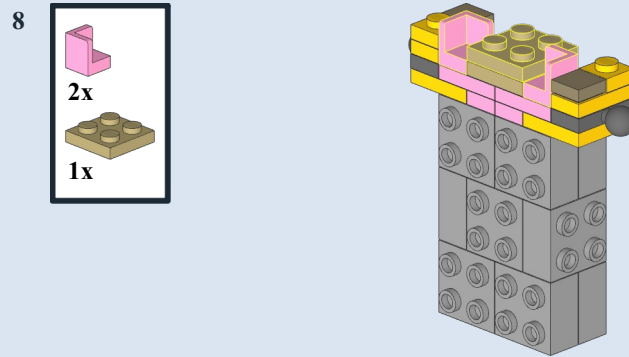
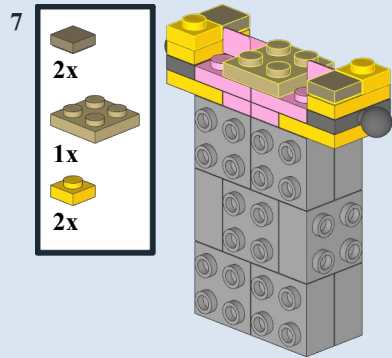
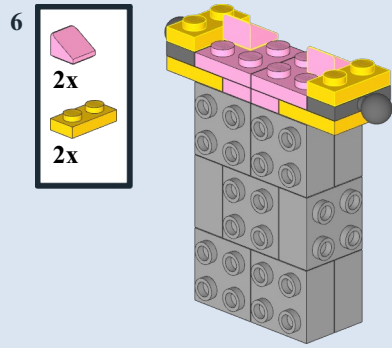
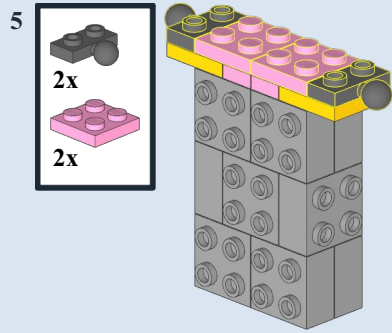
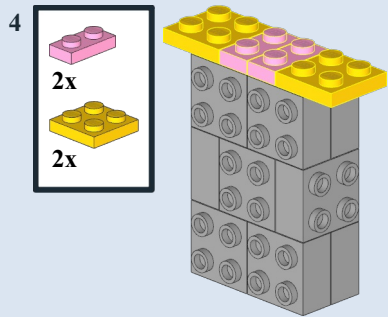
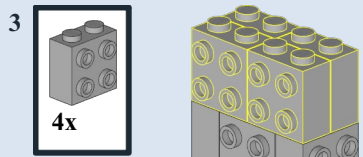
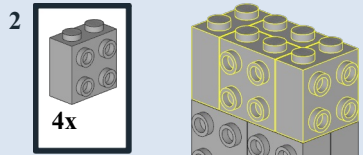
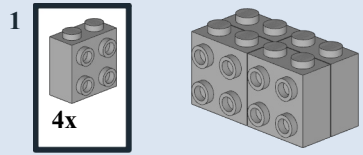

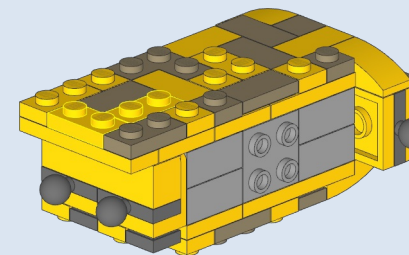
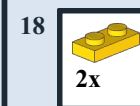
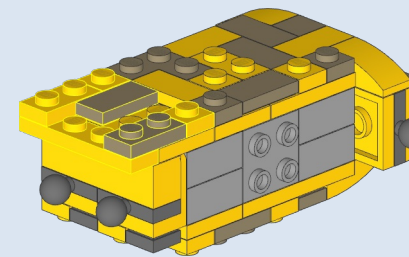
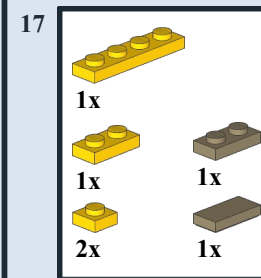
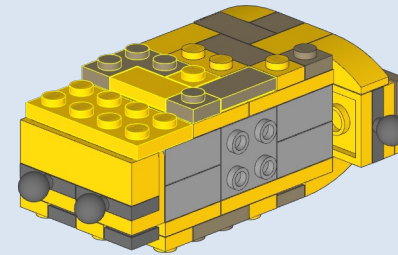
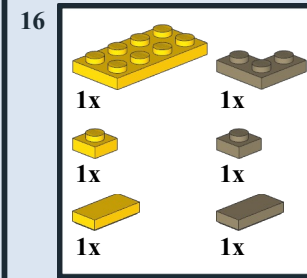
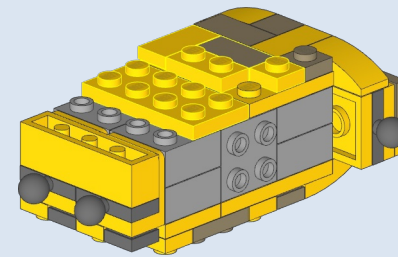
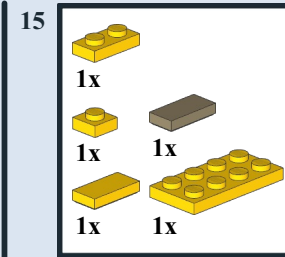
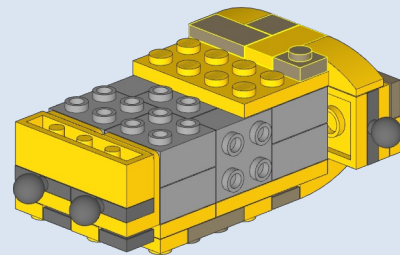
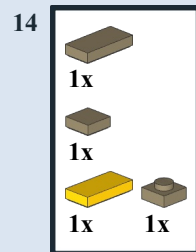
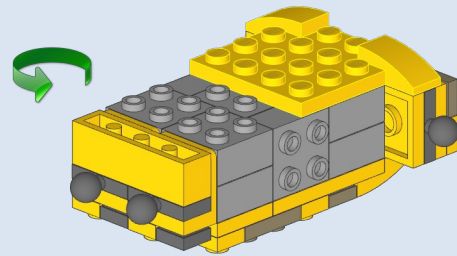
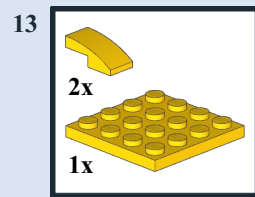
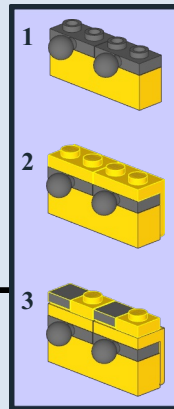
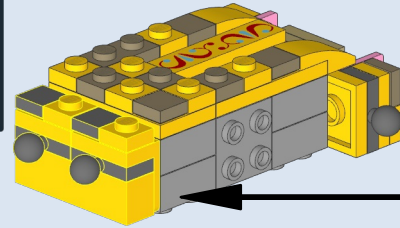
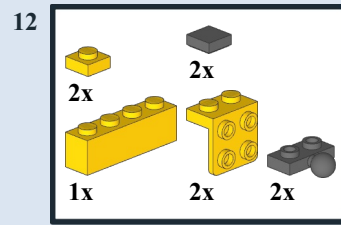
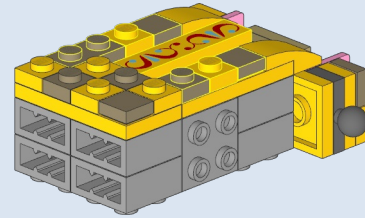
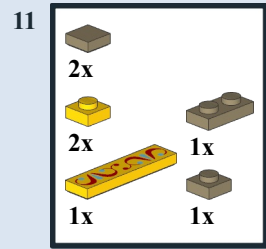

19

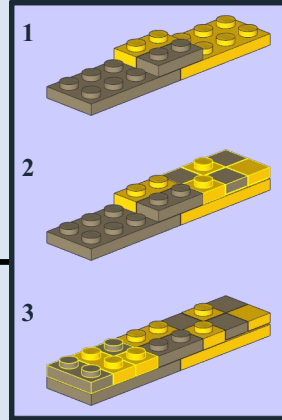
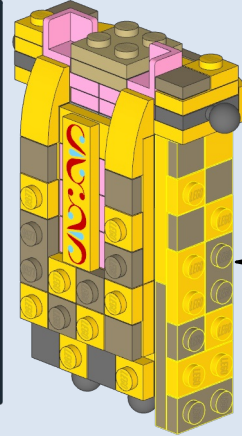
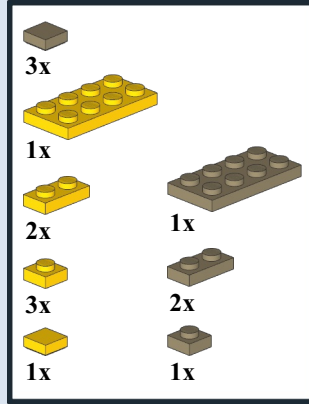

20

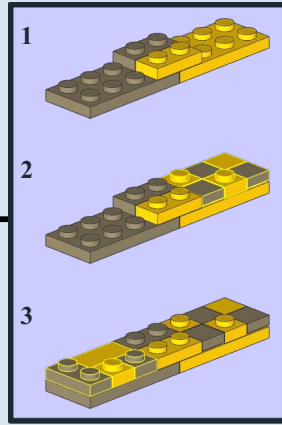
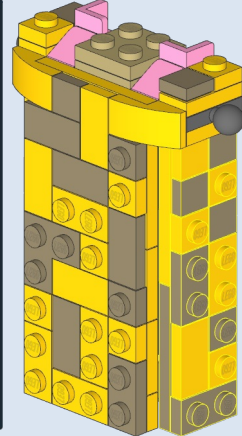
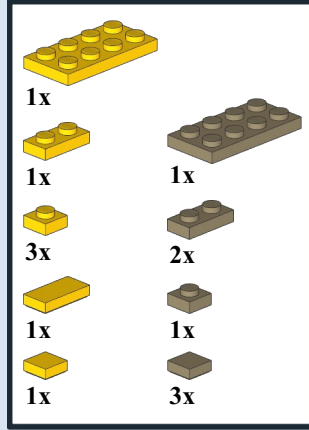

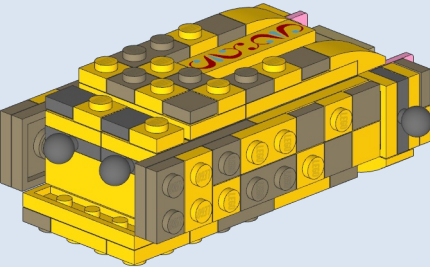

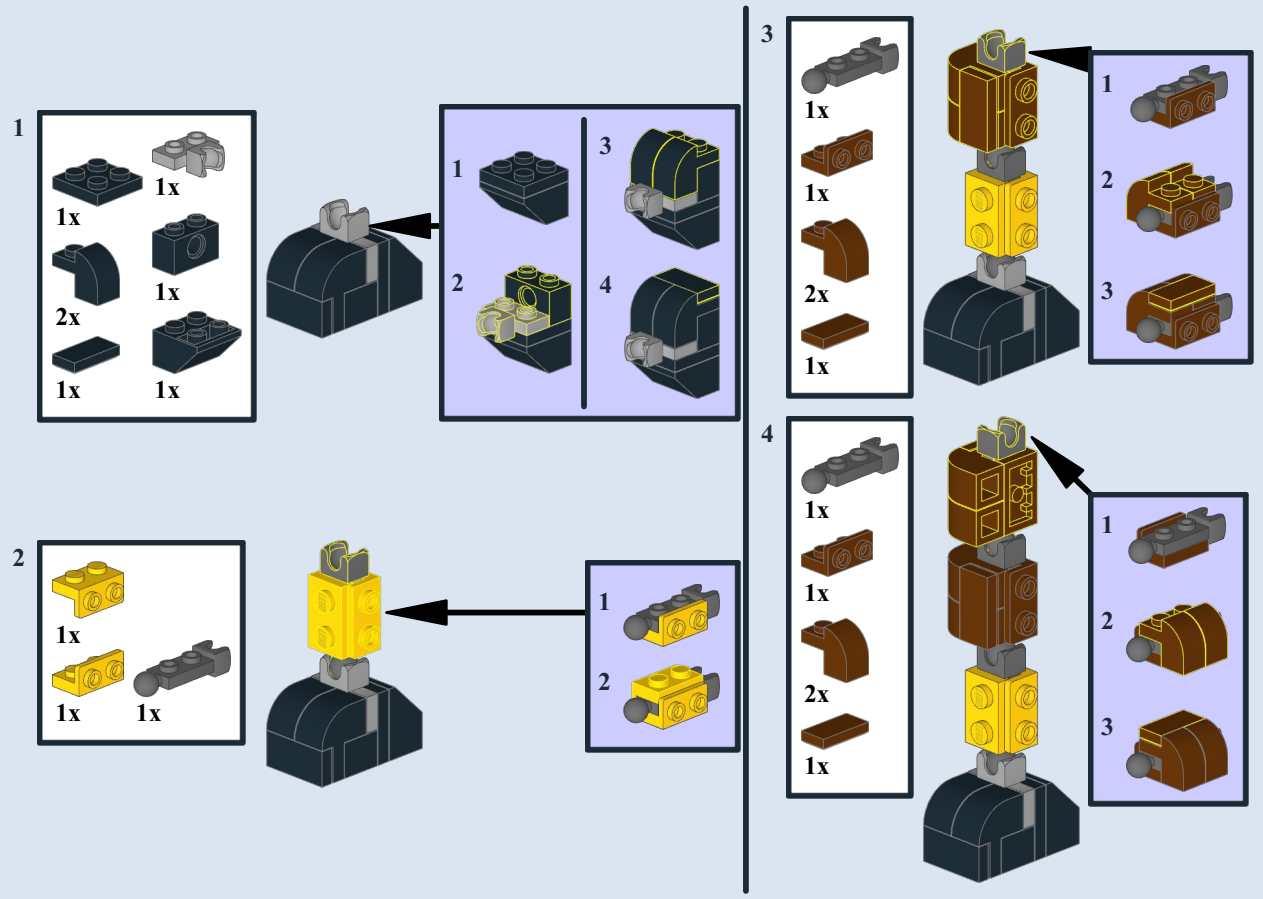

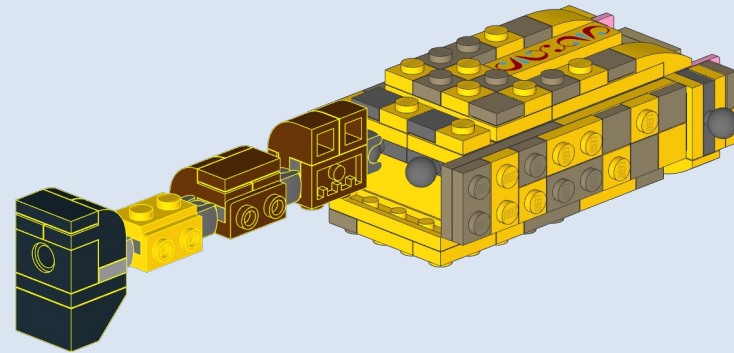

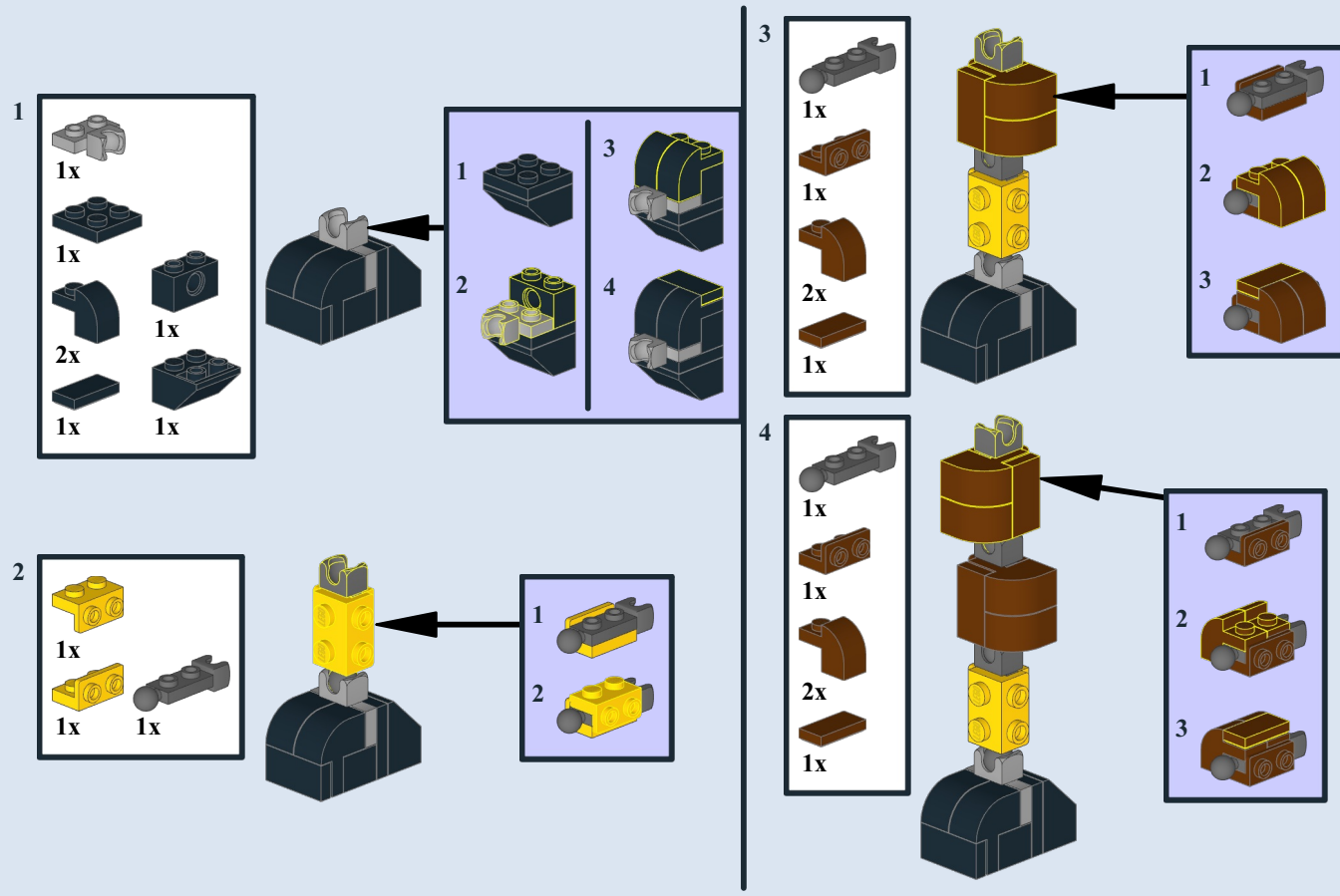

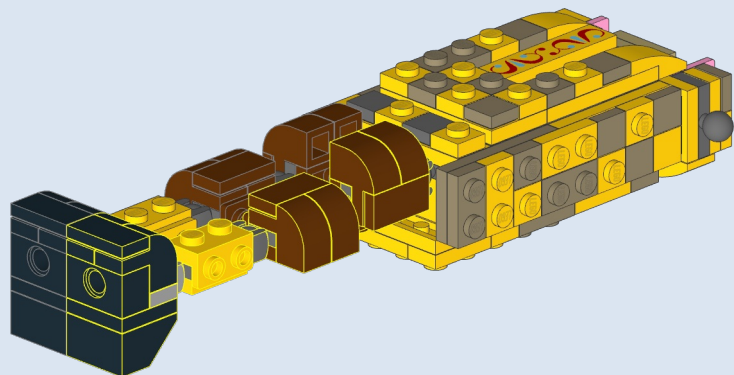

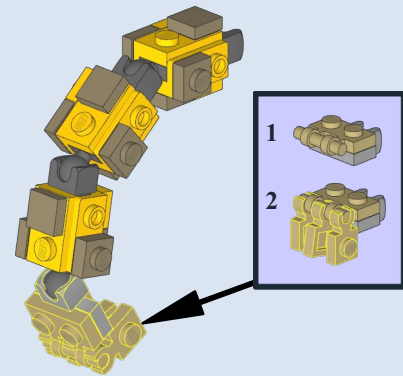
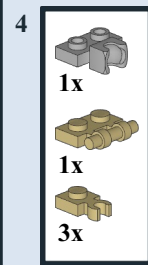
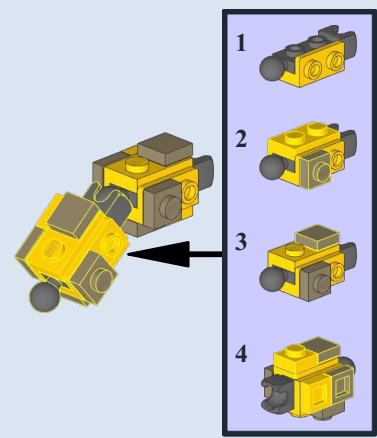
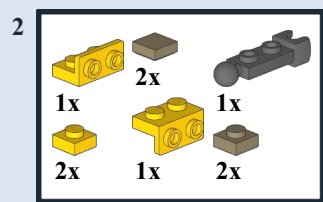
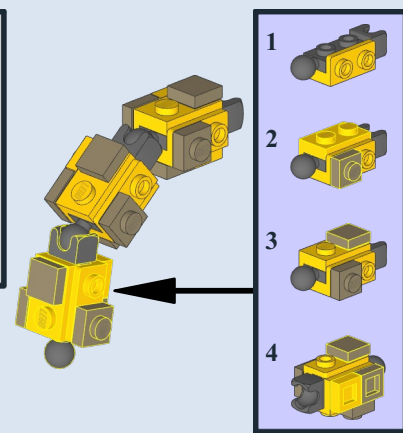
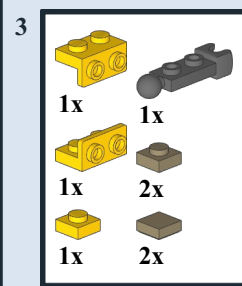
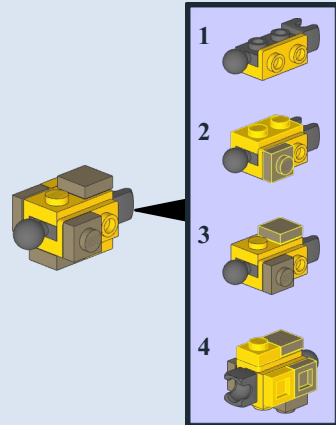
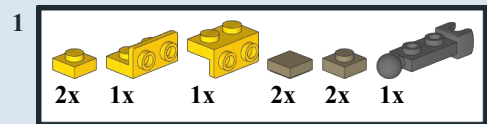



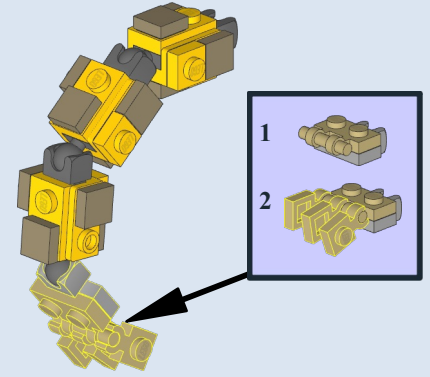
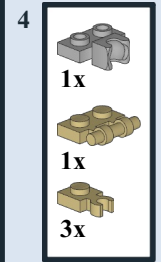
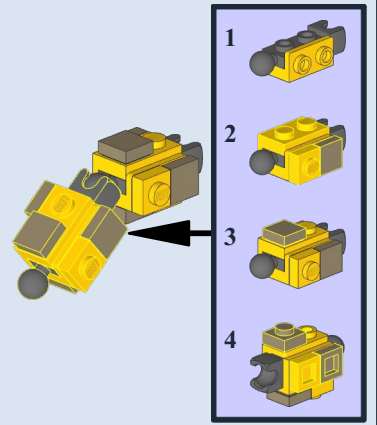
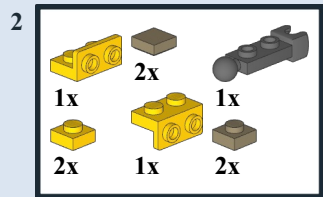
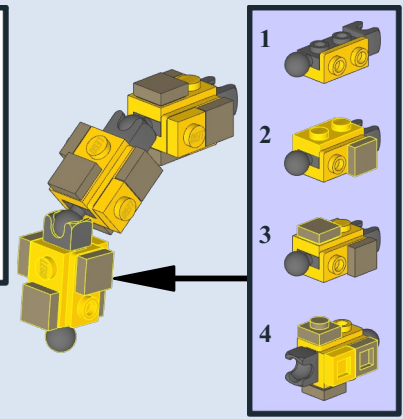
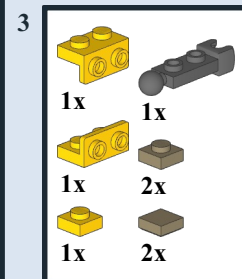
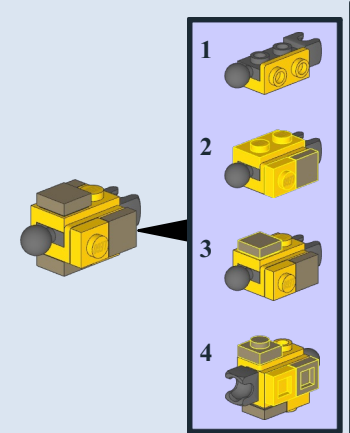
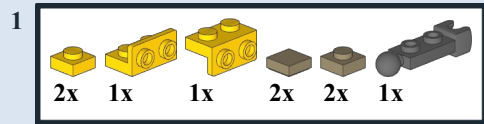



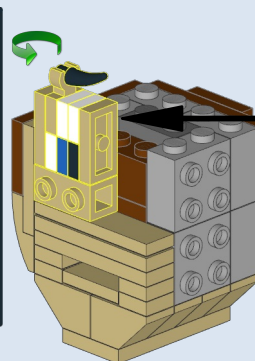
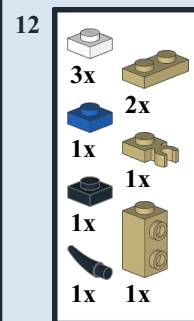
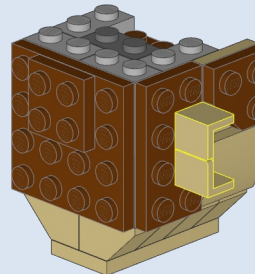
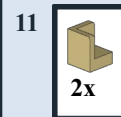
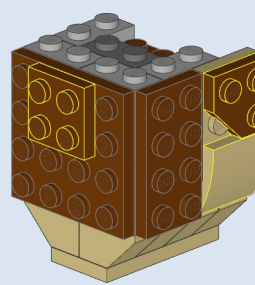
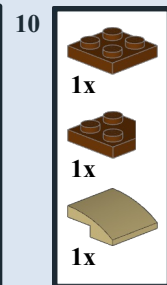
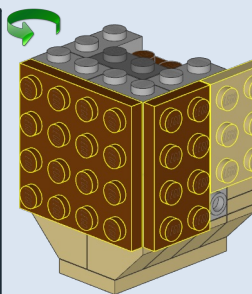
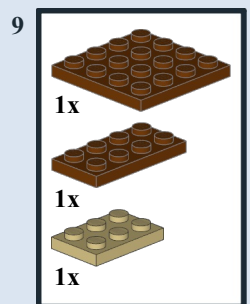
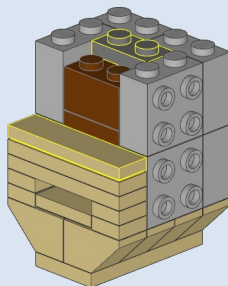
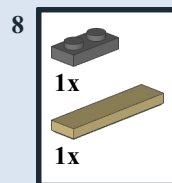
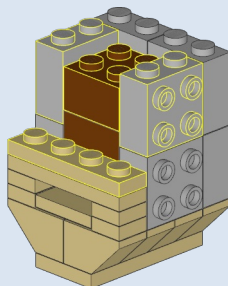
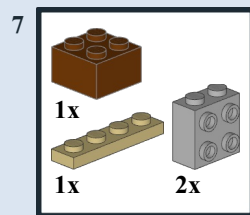
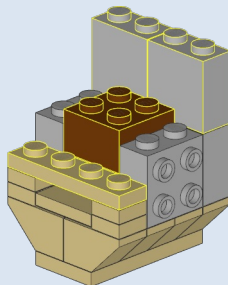
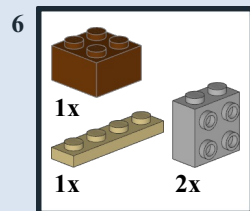
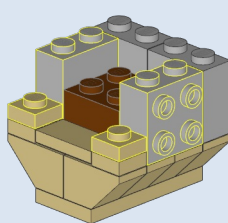
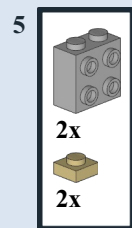
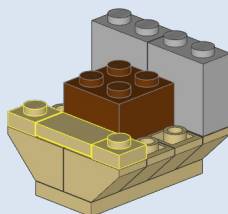
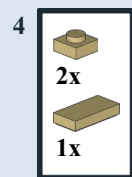
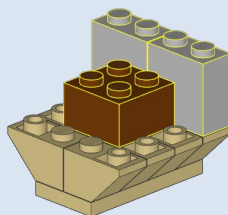
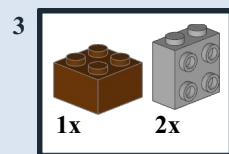
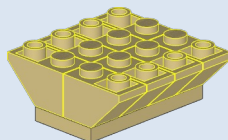
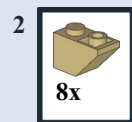
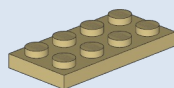
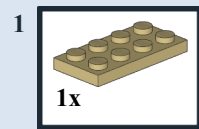

13

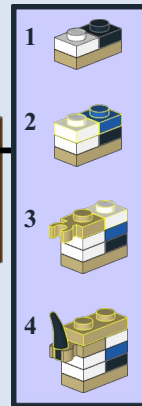
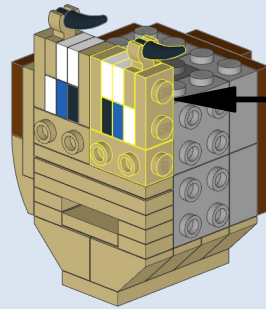
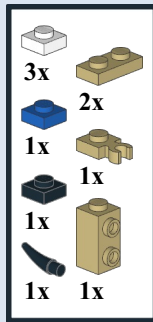

16

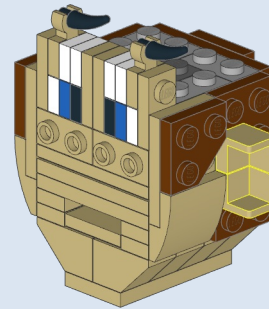
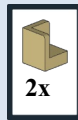

14

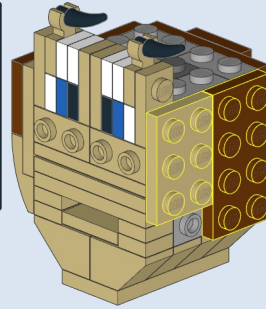
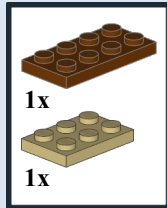

17

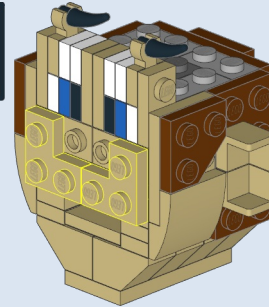
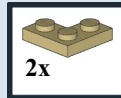

19

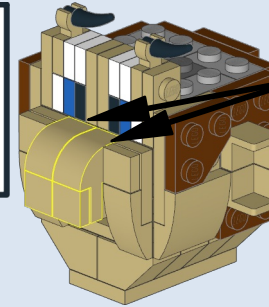
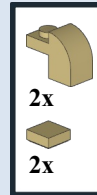

15

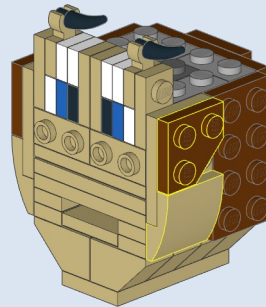
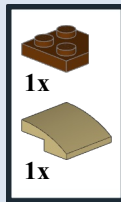

18

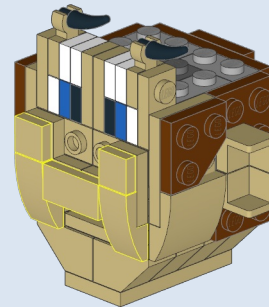
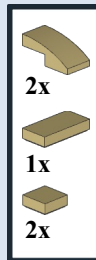

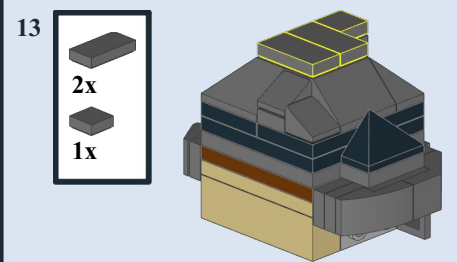
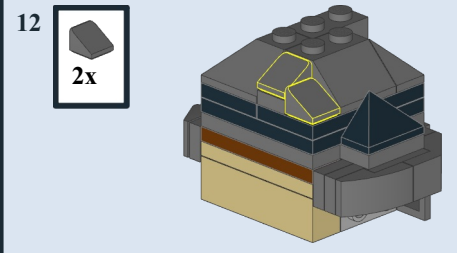
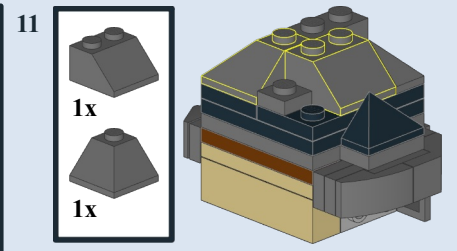
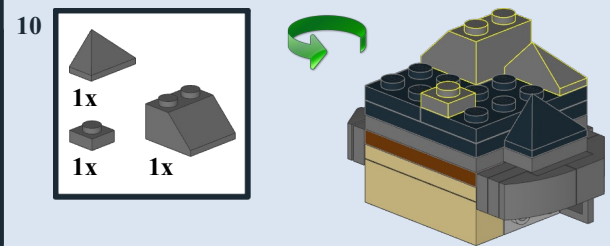
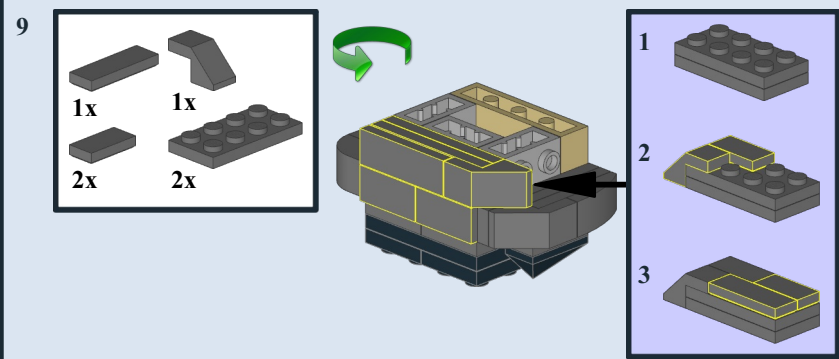
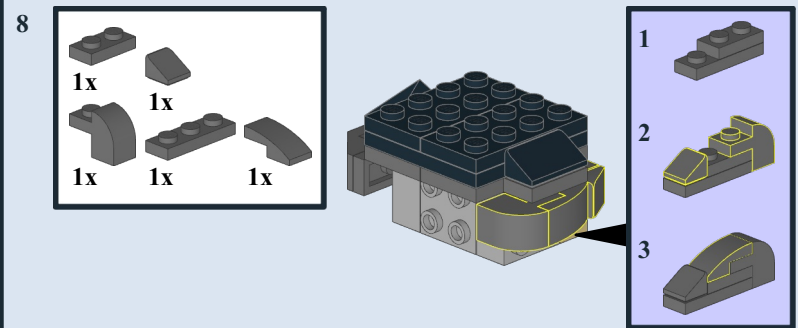
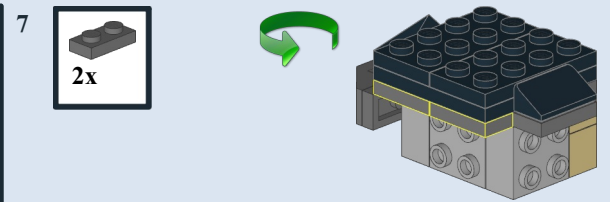
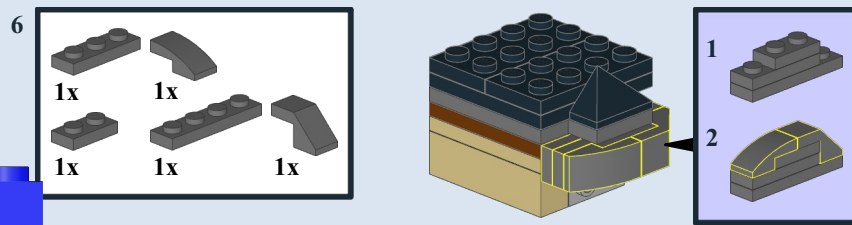
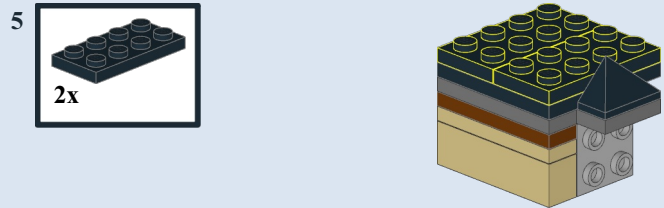
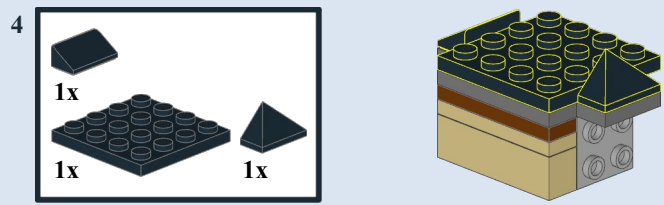
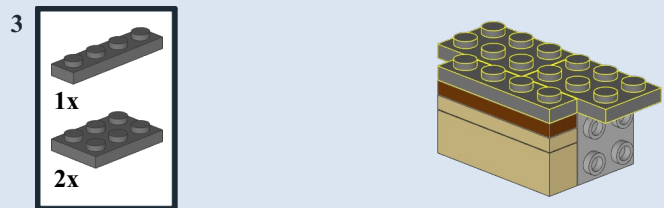
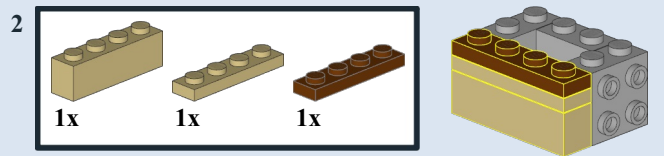
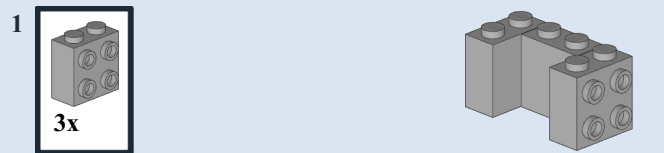

20

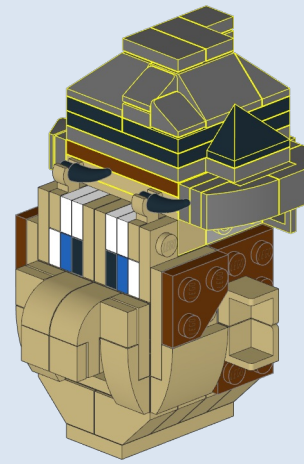

21

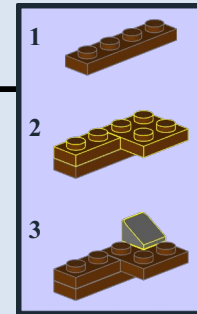
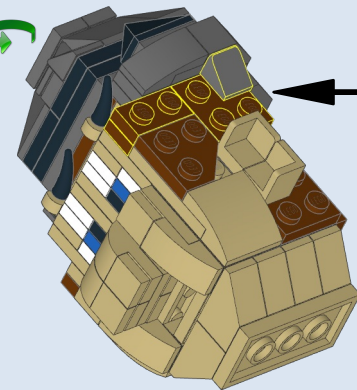
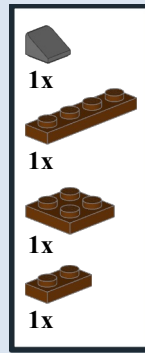

22

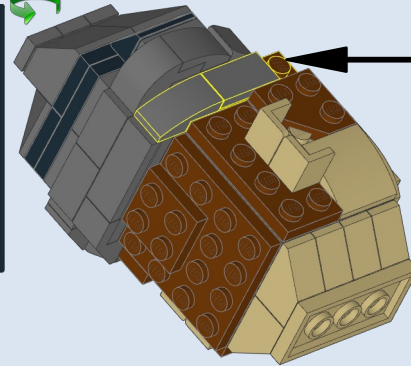
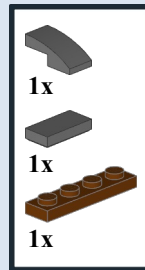





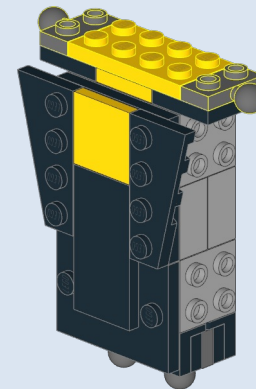
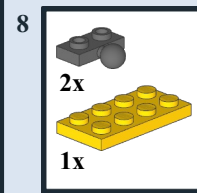
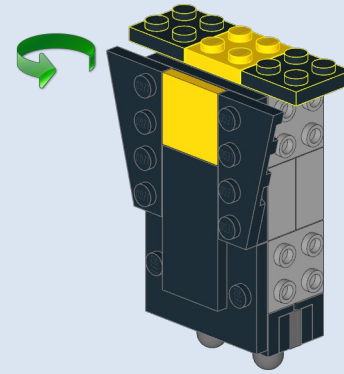
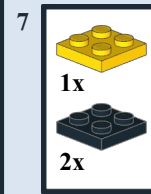
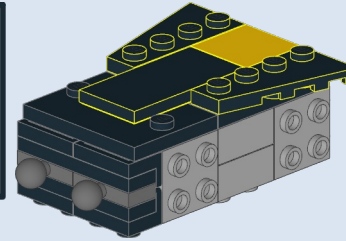
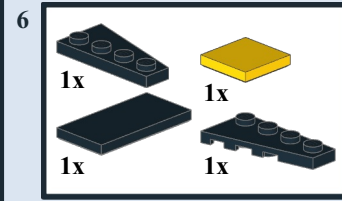
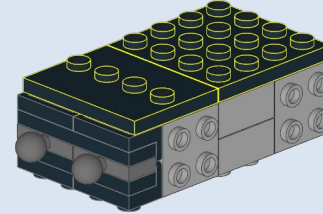
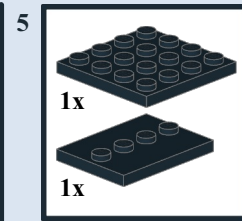
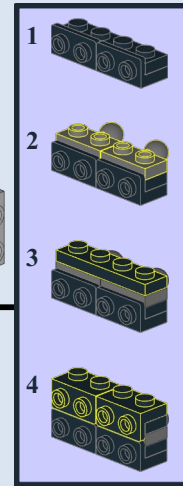
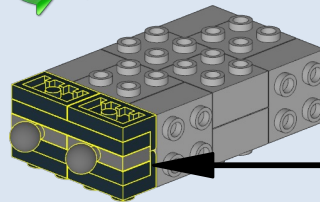
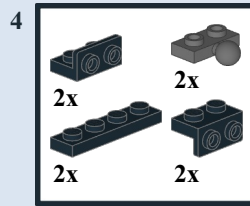
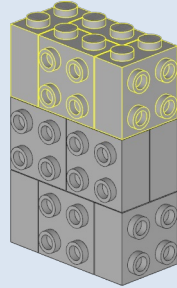
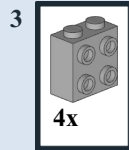
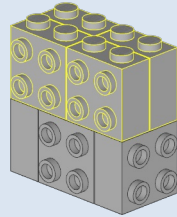
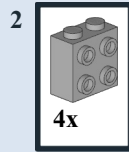
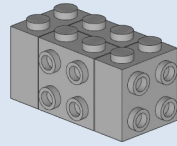
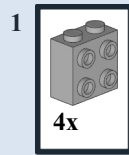

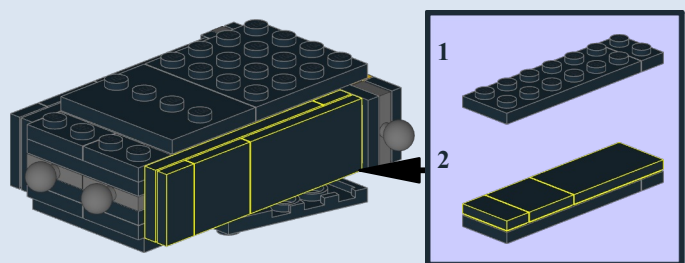
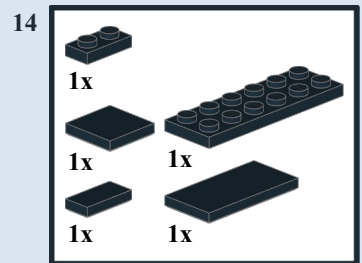
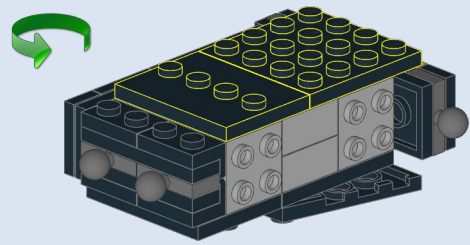
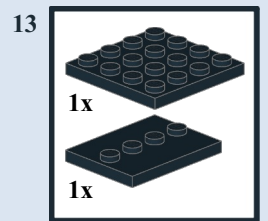
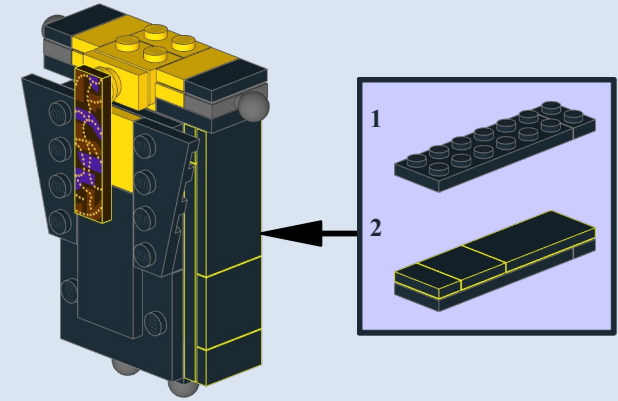
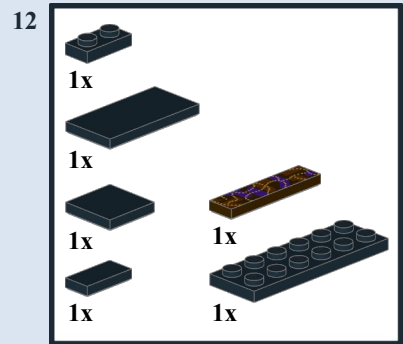
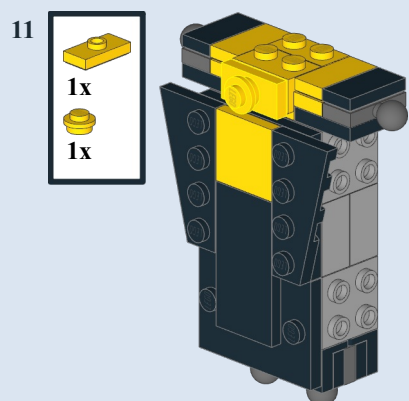
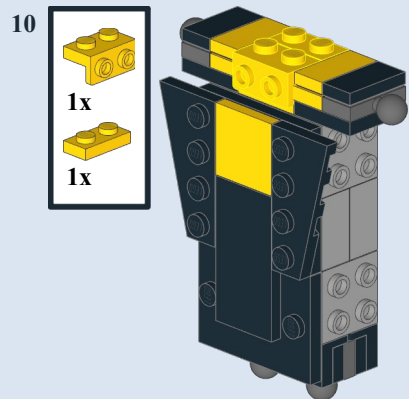
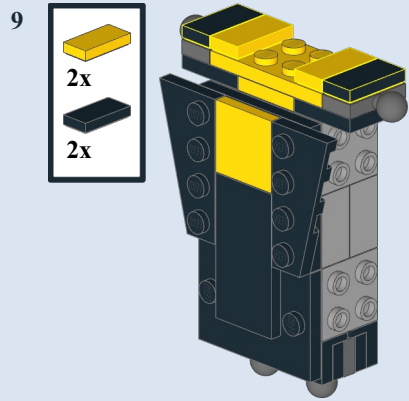

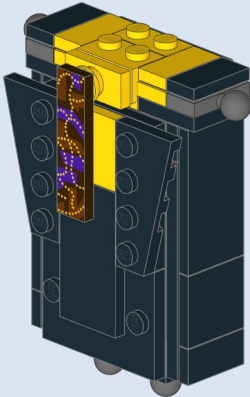

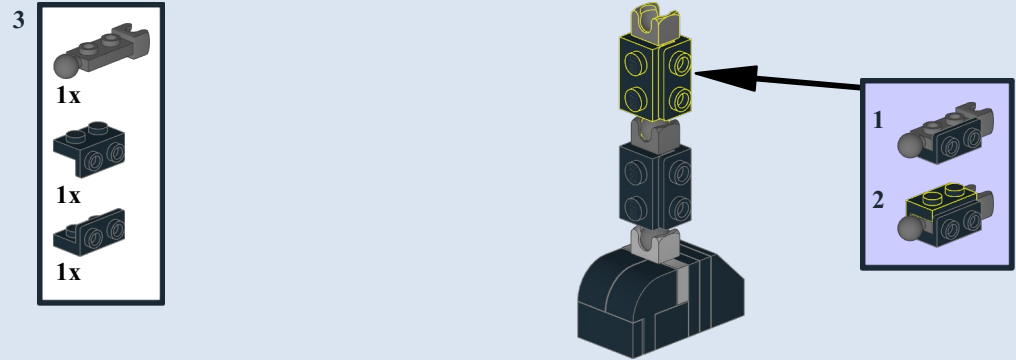
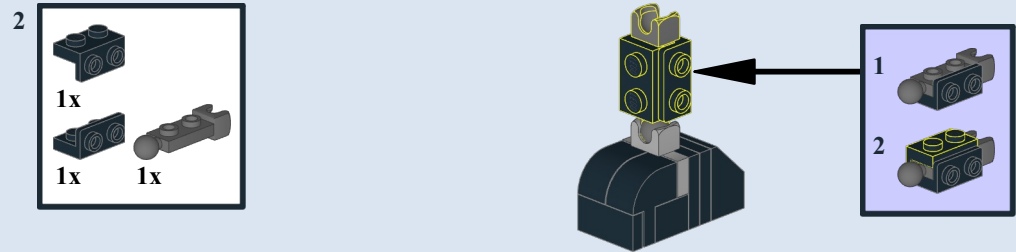
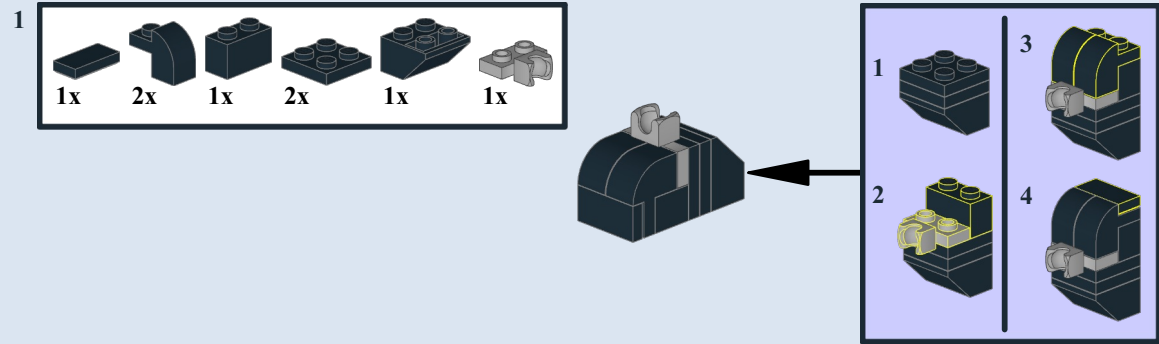

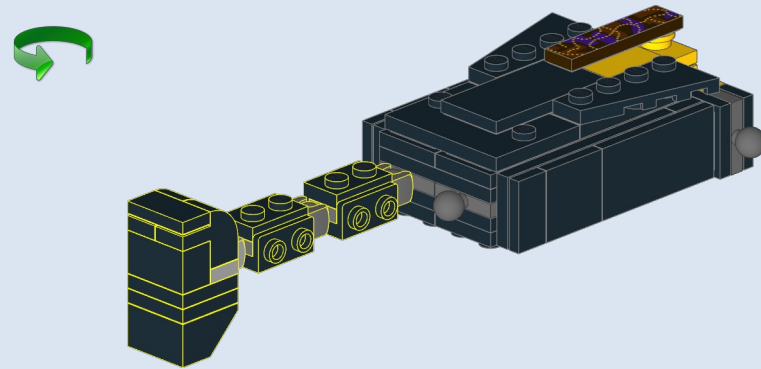

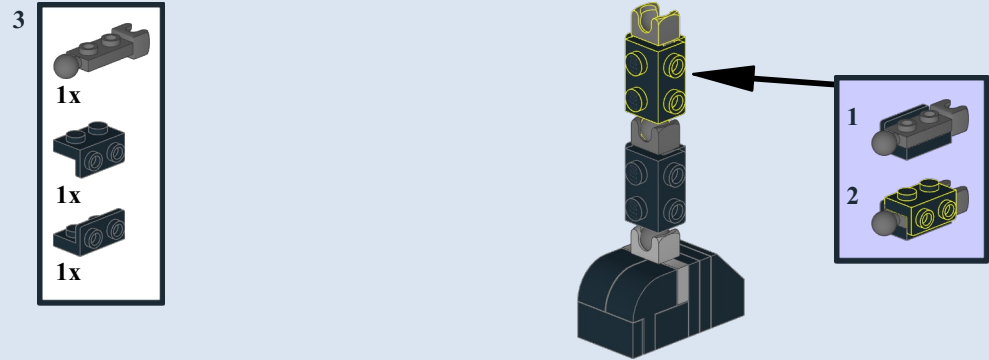
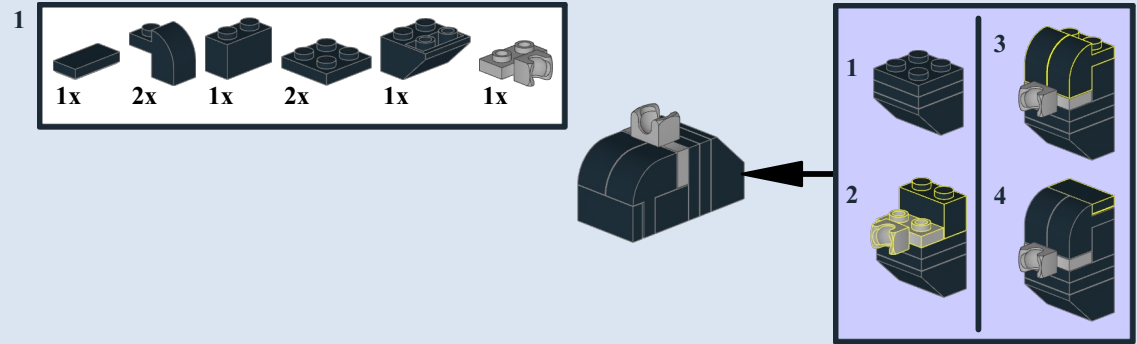

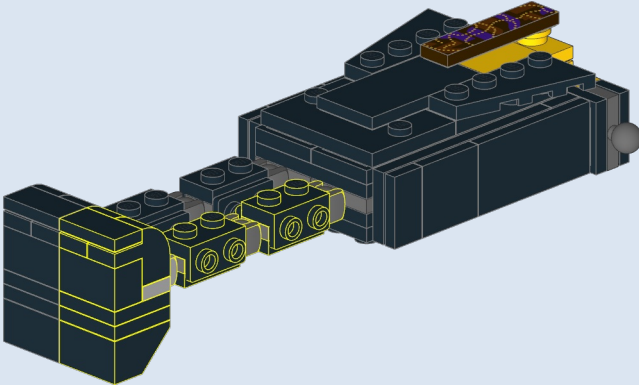

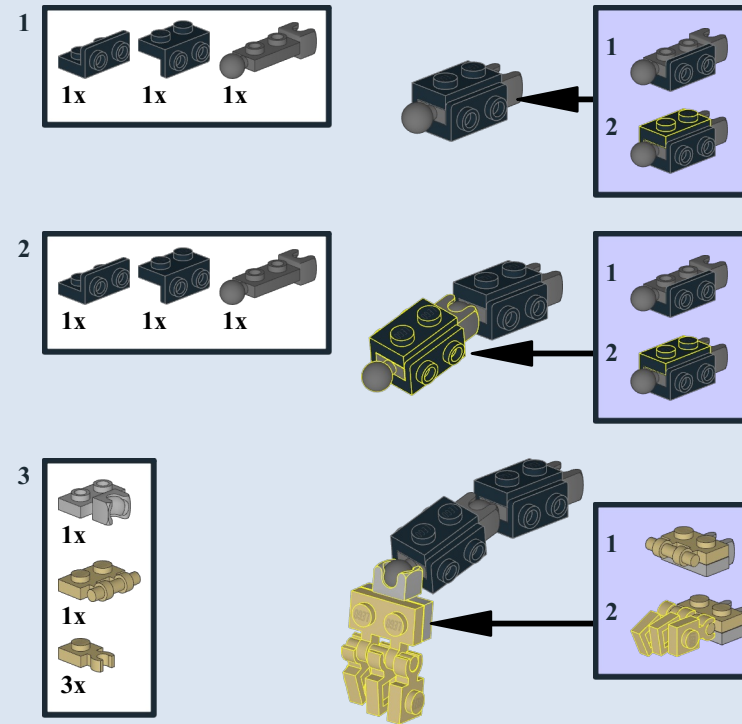

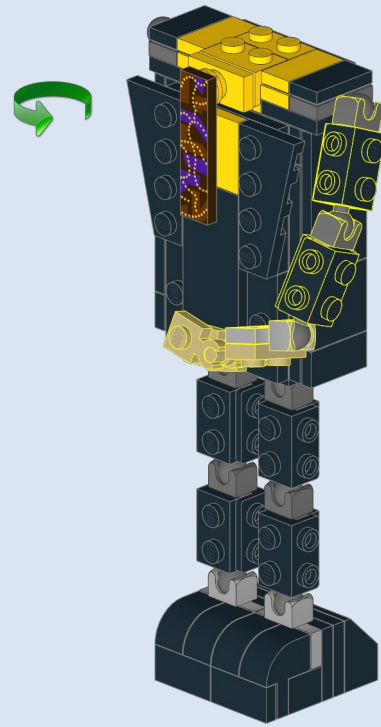

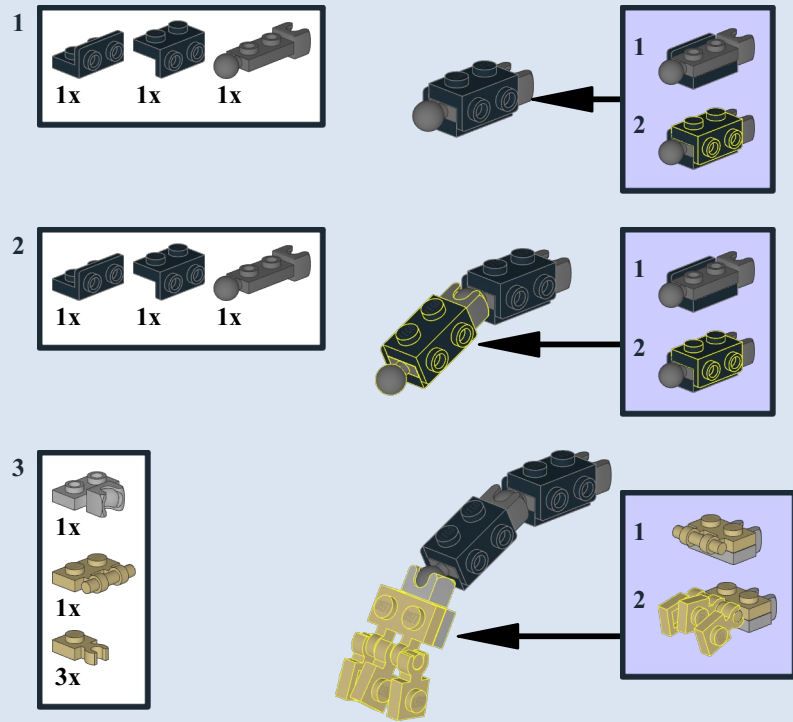

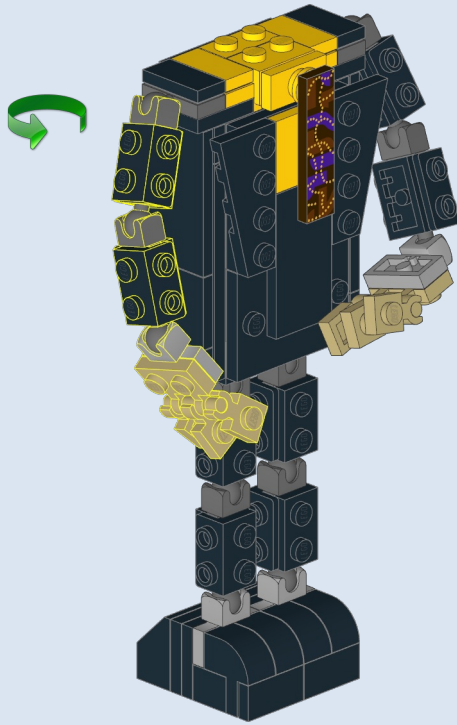

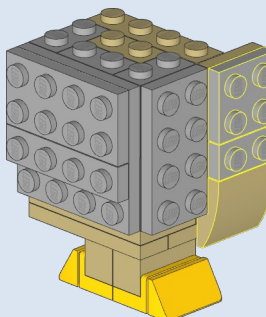
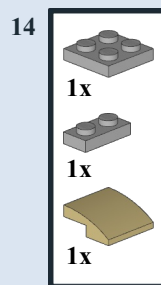
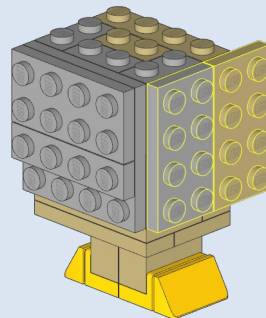
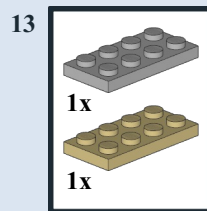
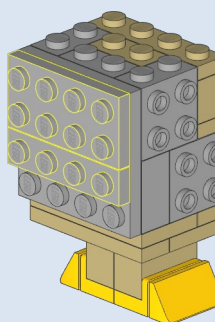
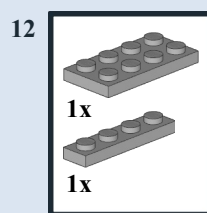
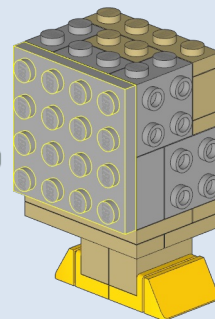
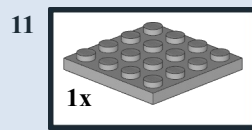
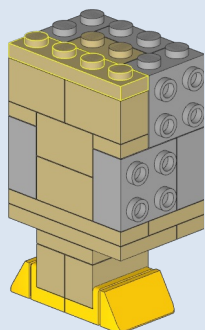
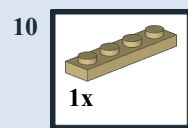
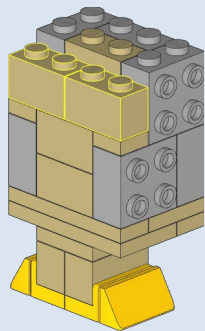
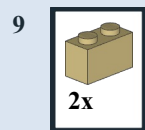
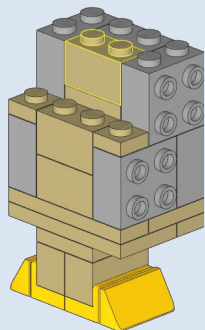
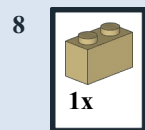
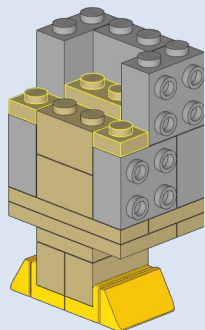
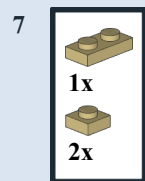
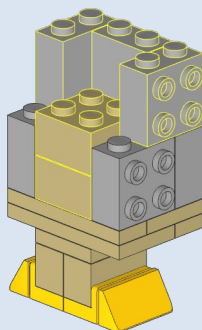
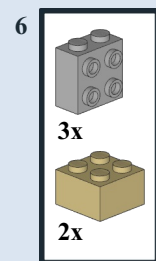
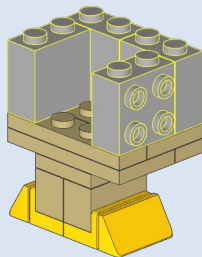
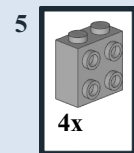
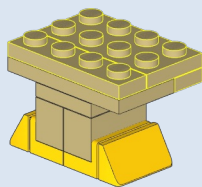
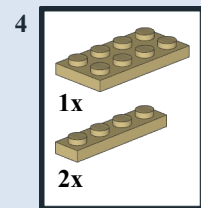
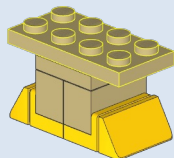
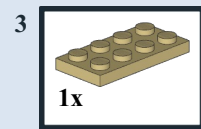
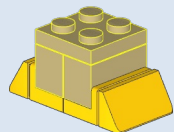
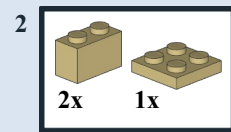
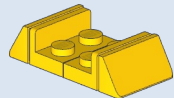
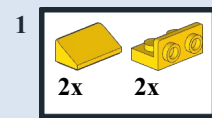

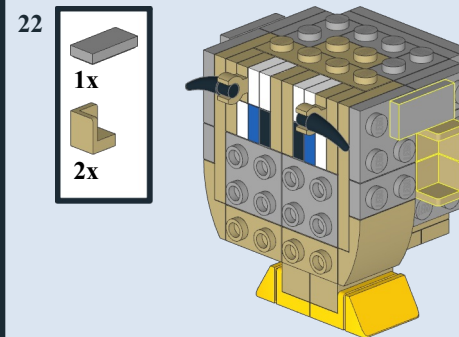
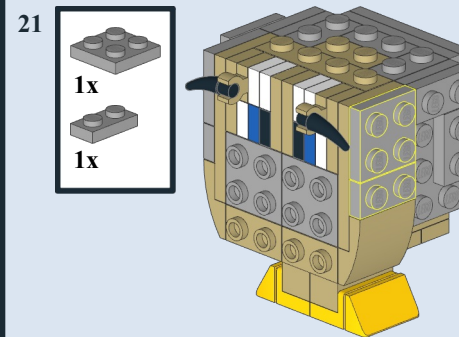
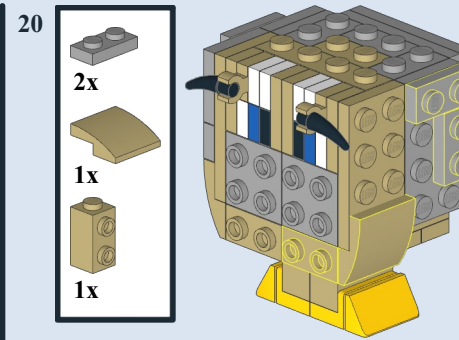
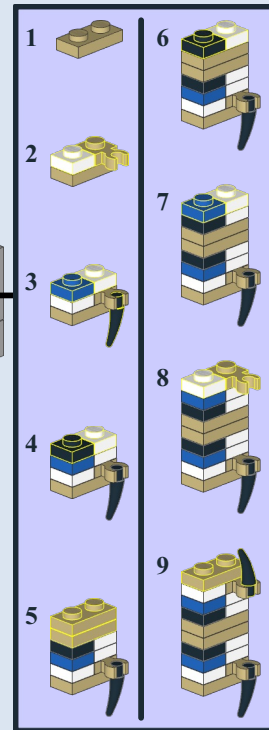
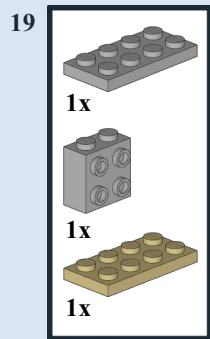
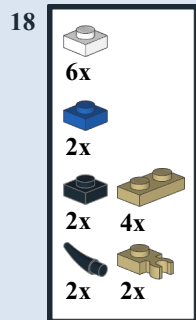
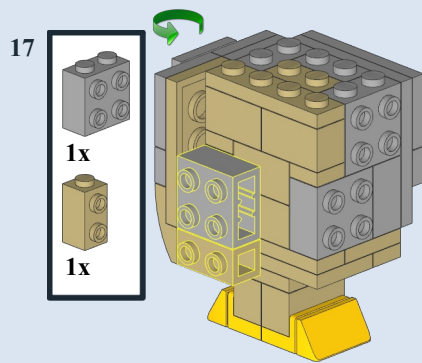
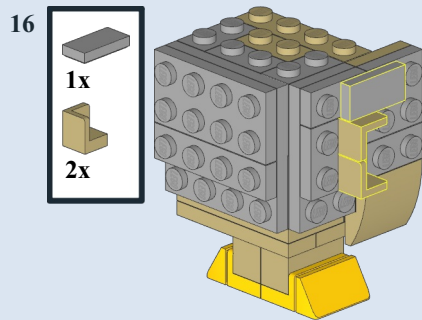
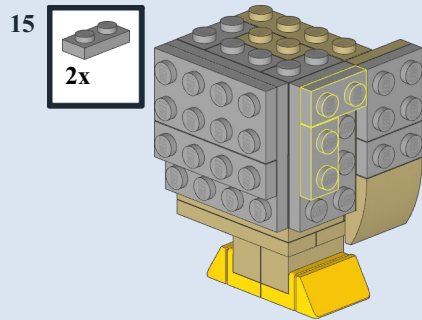

23

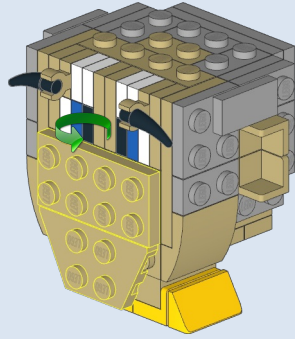
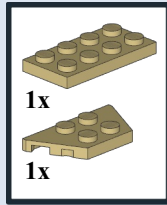

24

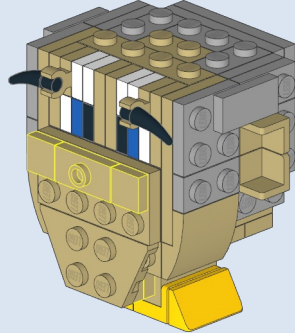
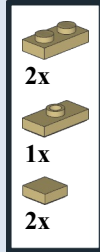

25

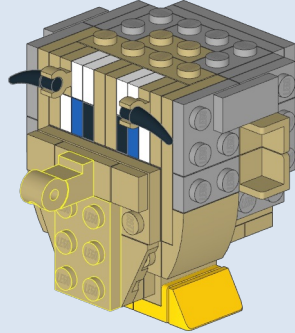
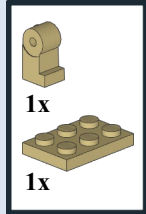

26

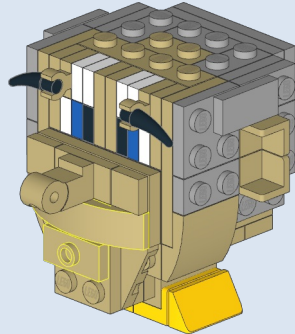
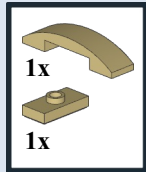

27

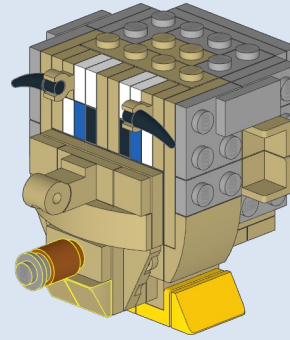

28

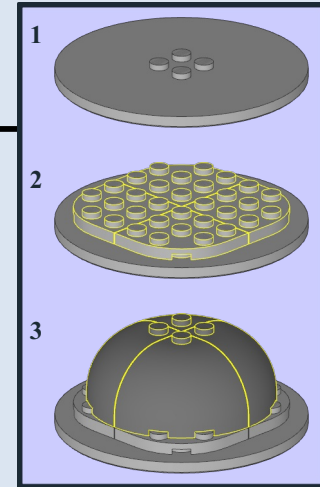
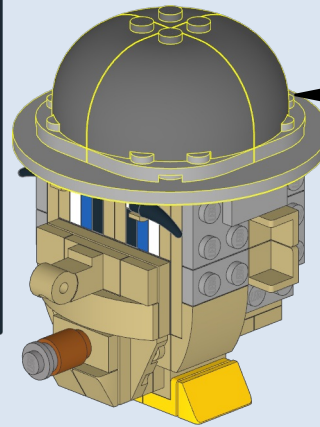
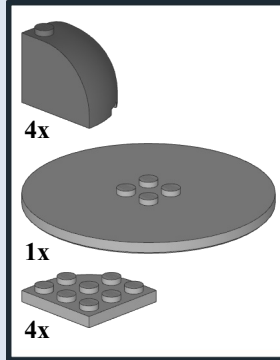





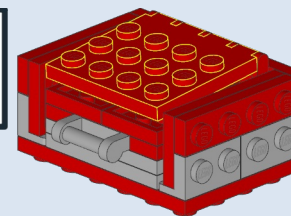
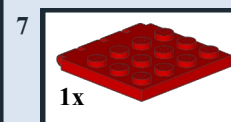
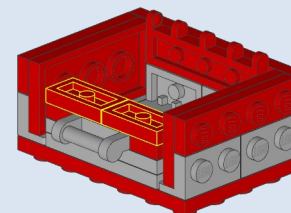
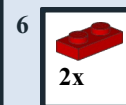
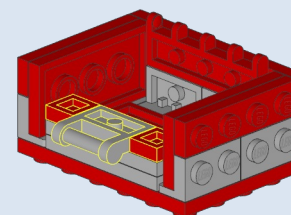
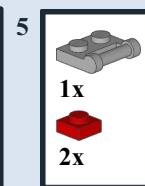
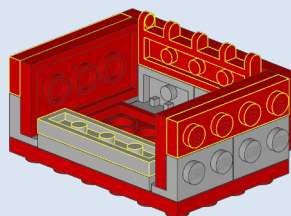
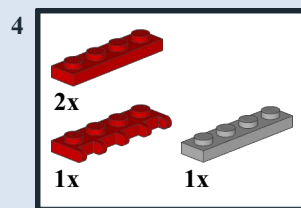
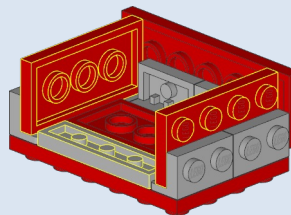
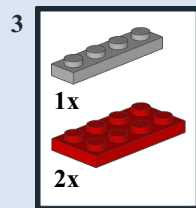
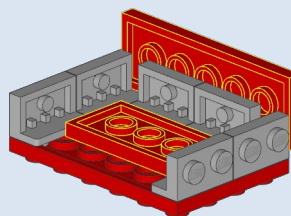
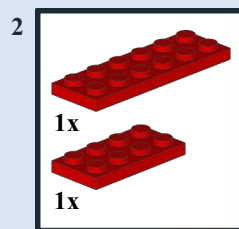
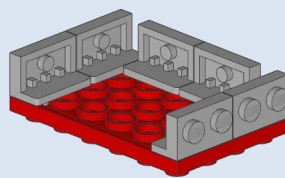
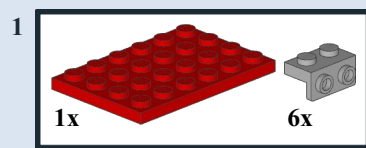



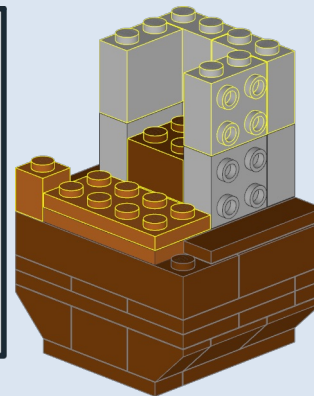
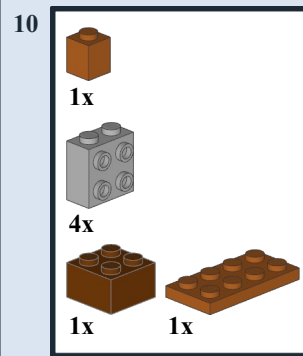
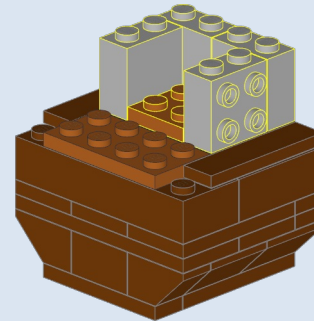
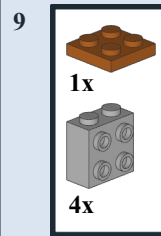
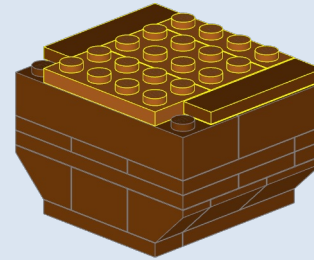
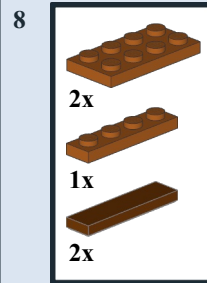
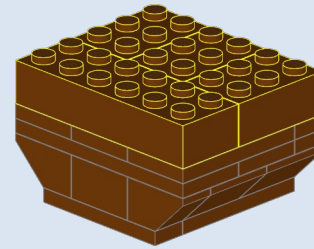
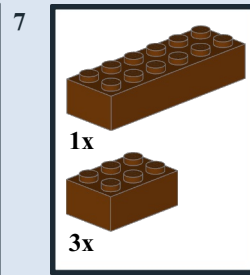
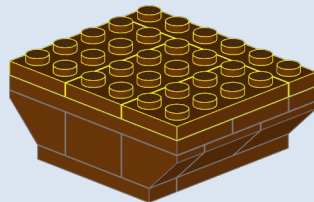
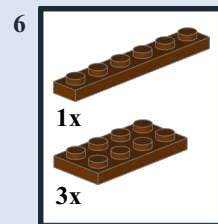
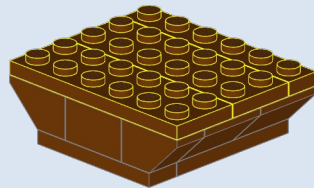
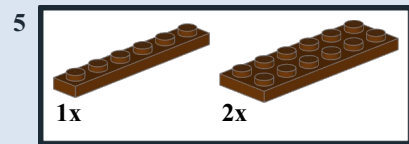
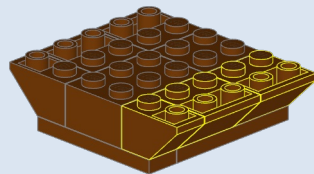
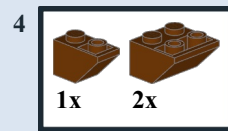
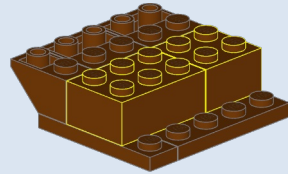
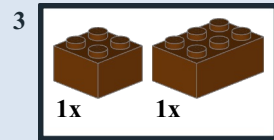
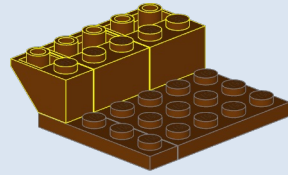
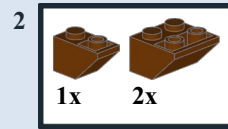
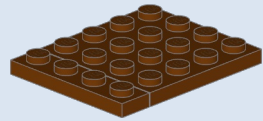
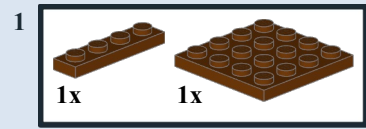

11

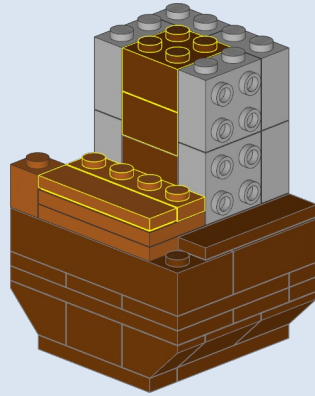
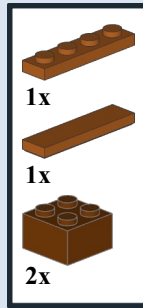

14

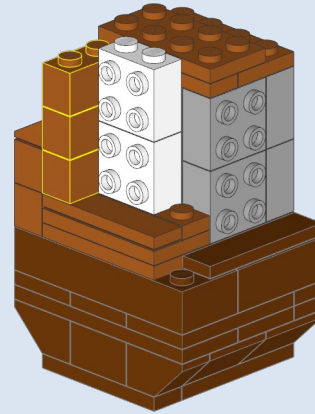
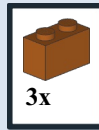

12

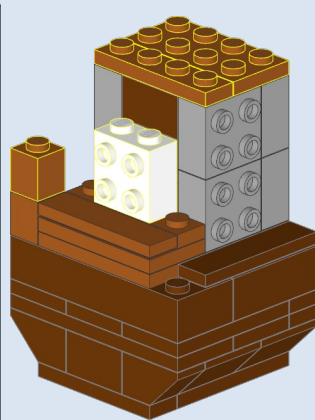
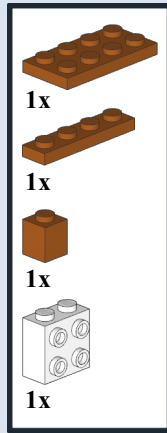

15

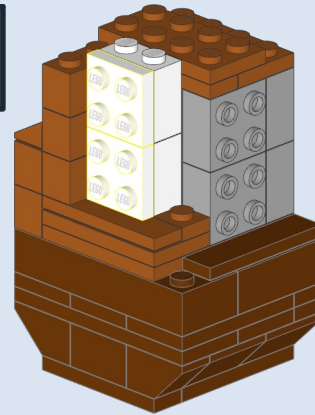
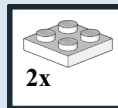

13

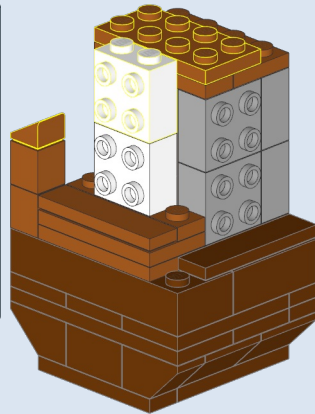
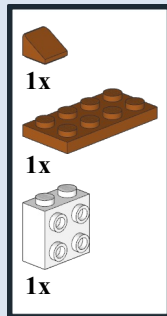

16

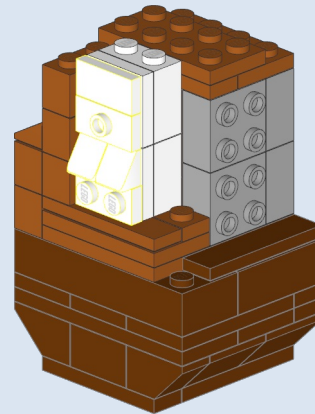
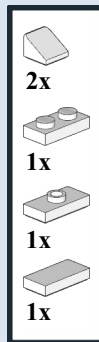

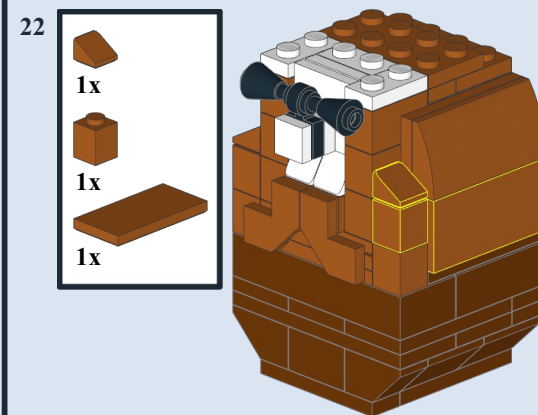
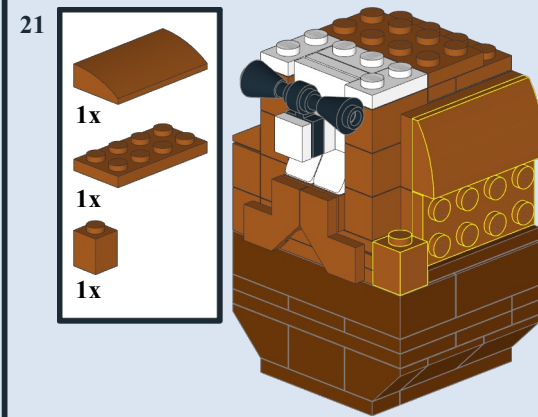
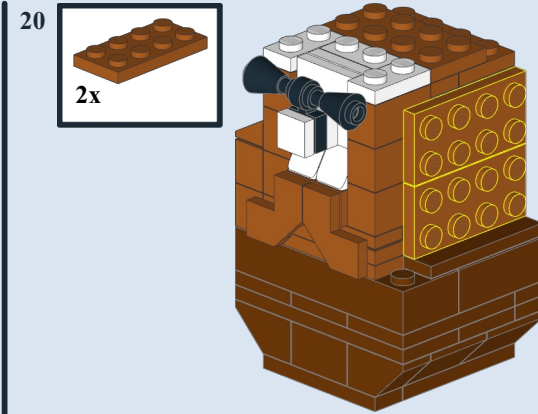
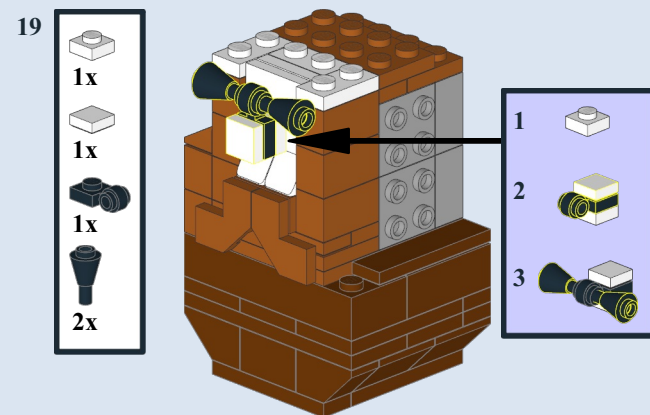
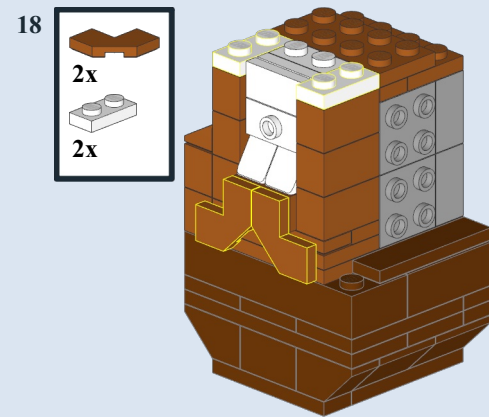
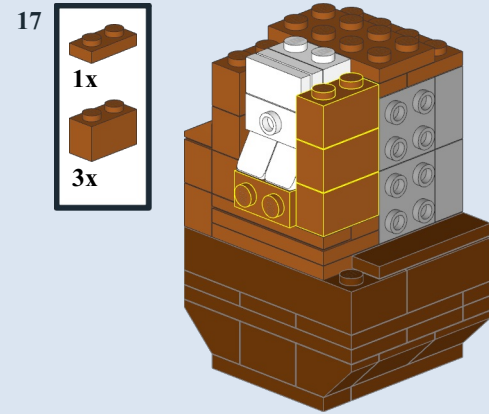

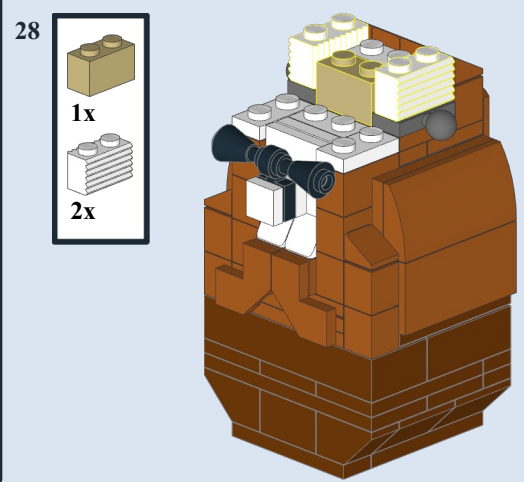
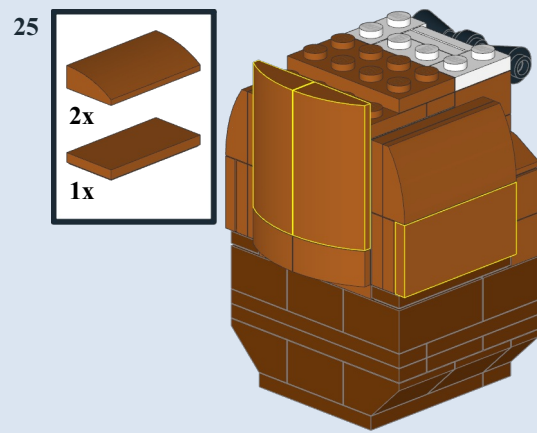
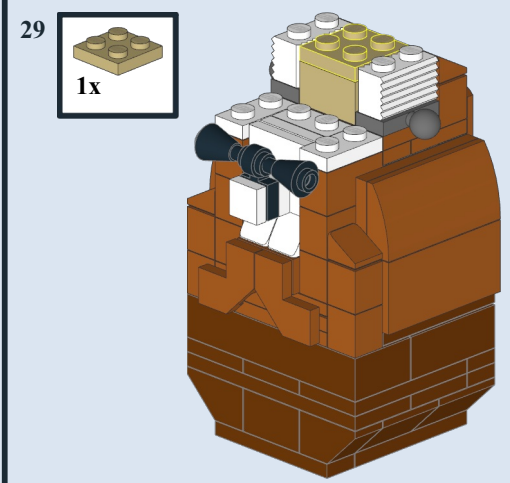
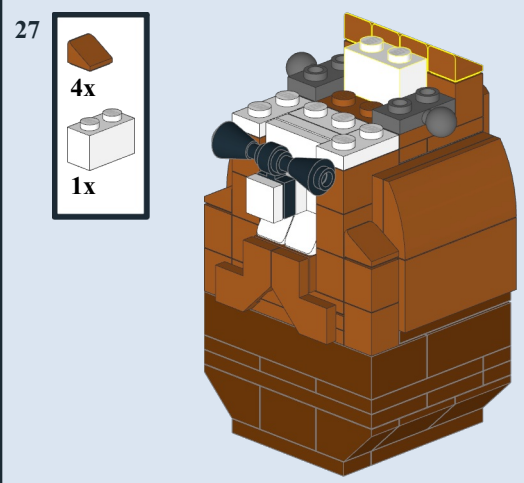
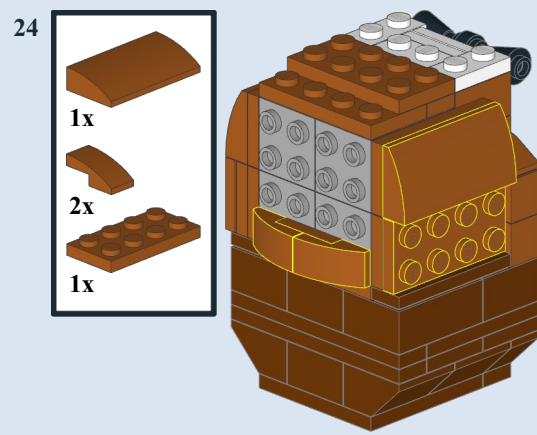
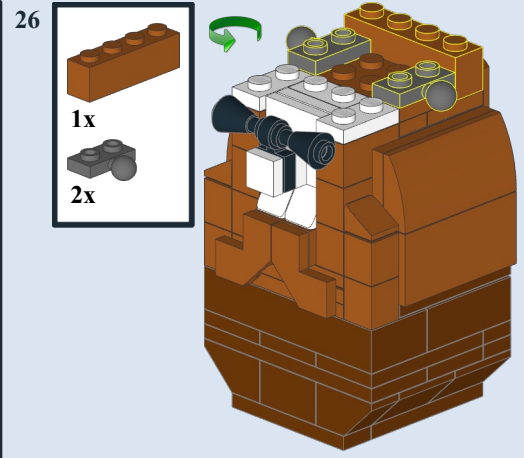
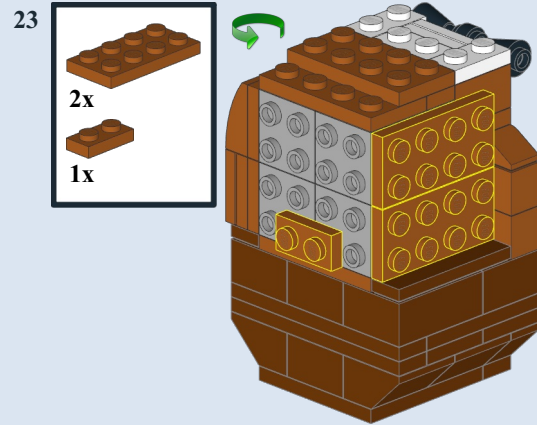

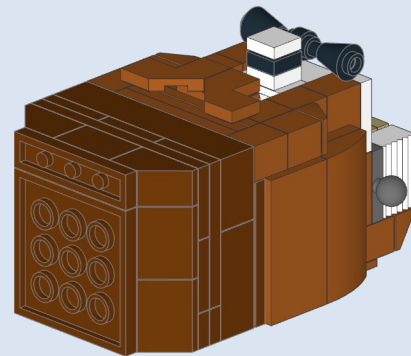

2

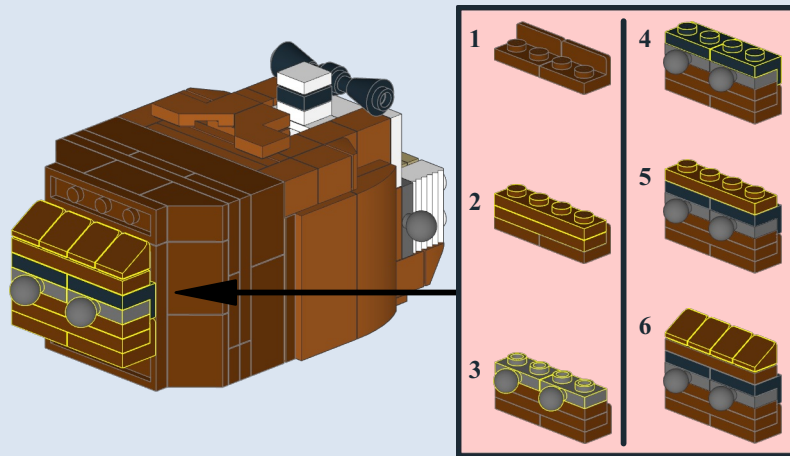
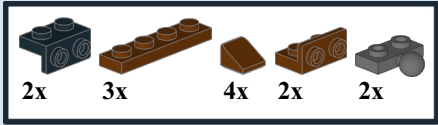

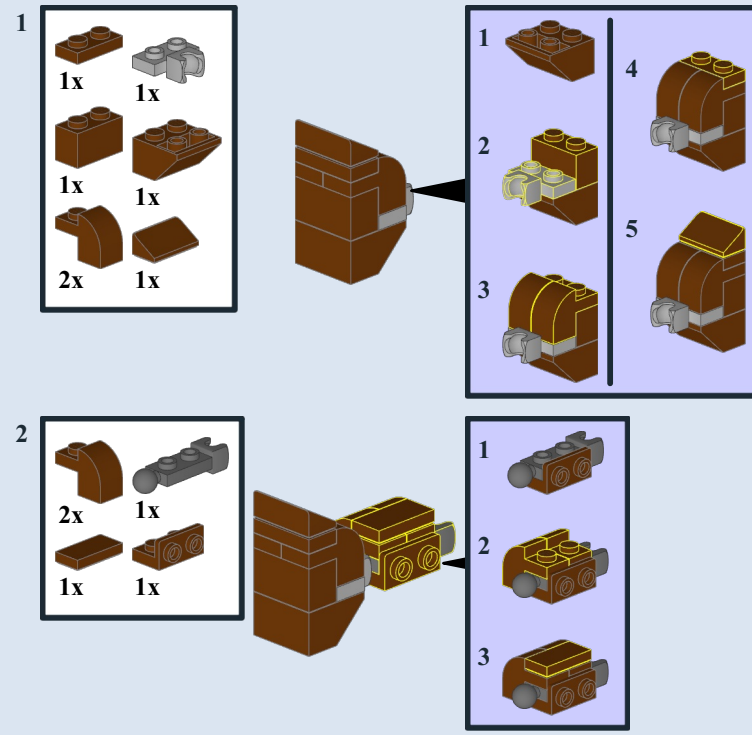

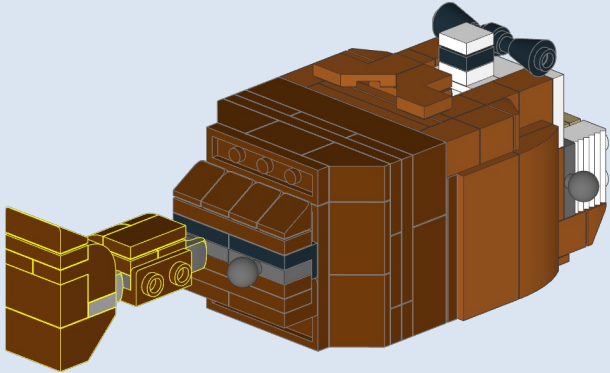

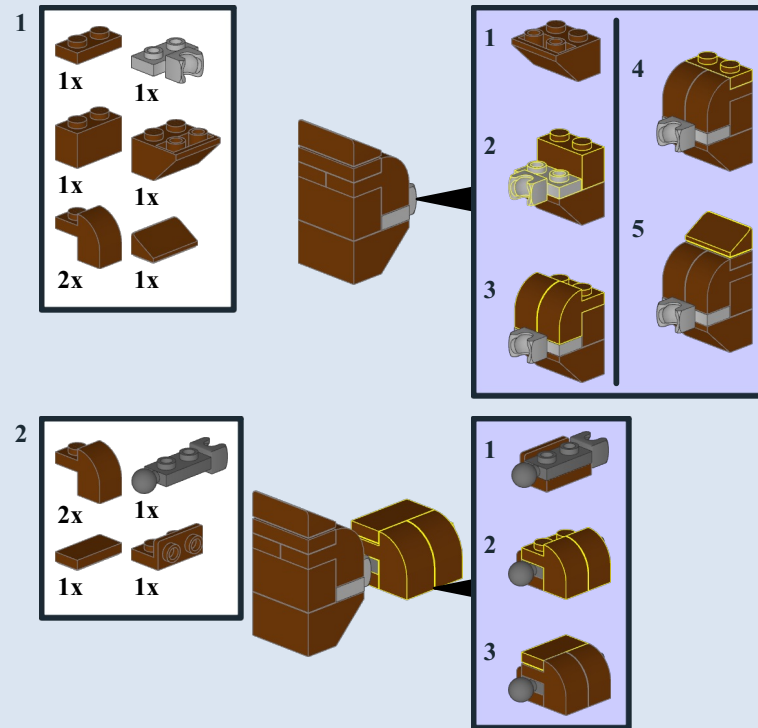

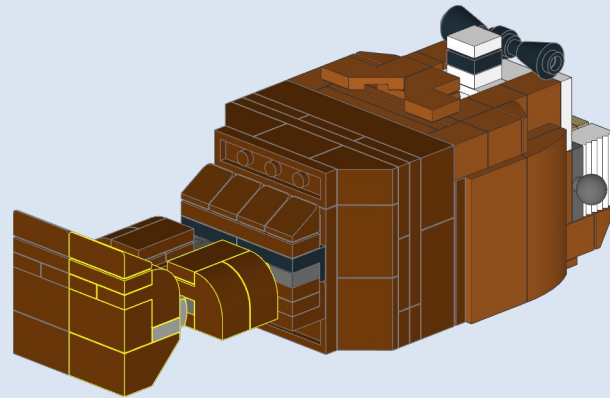

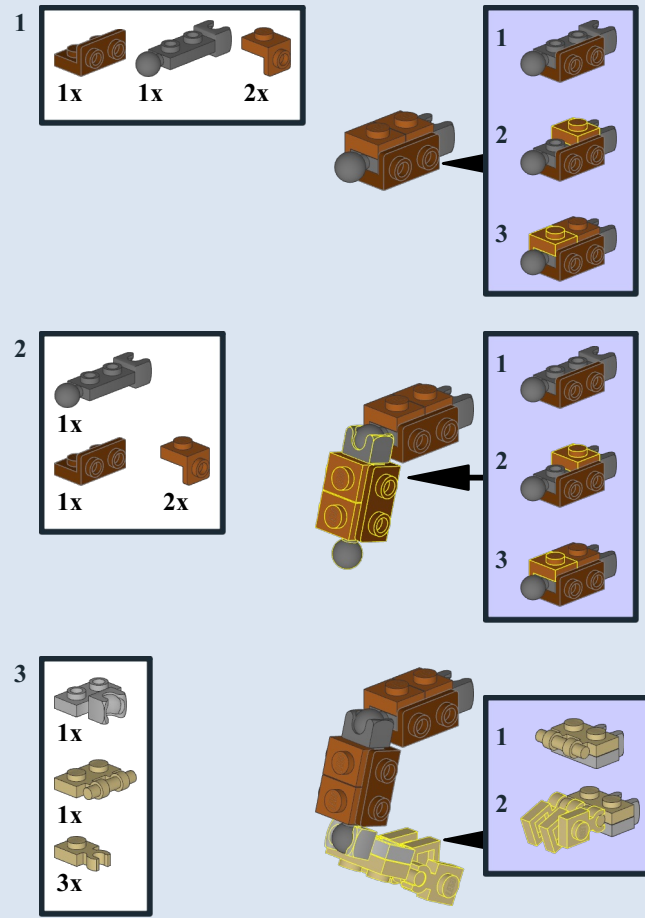

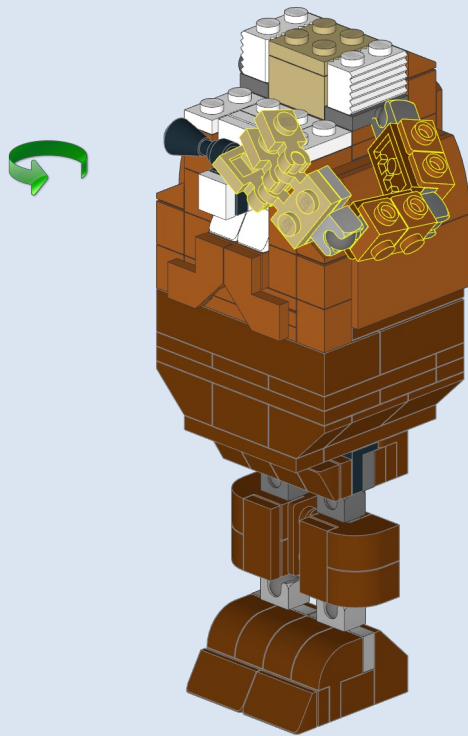

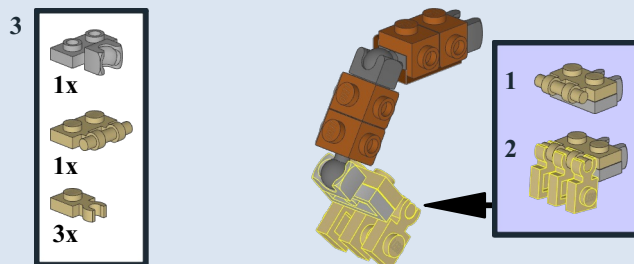
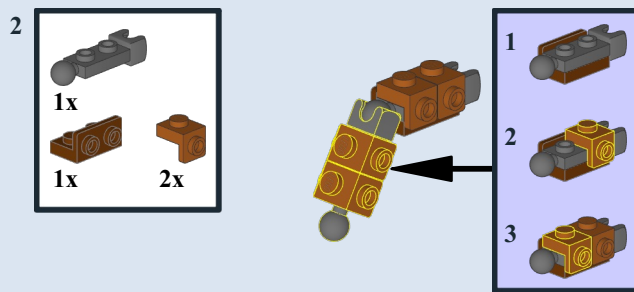
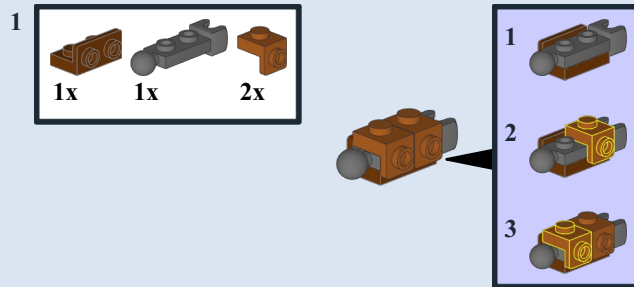

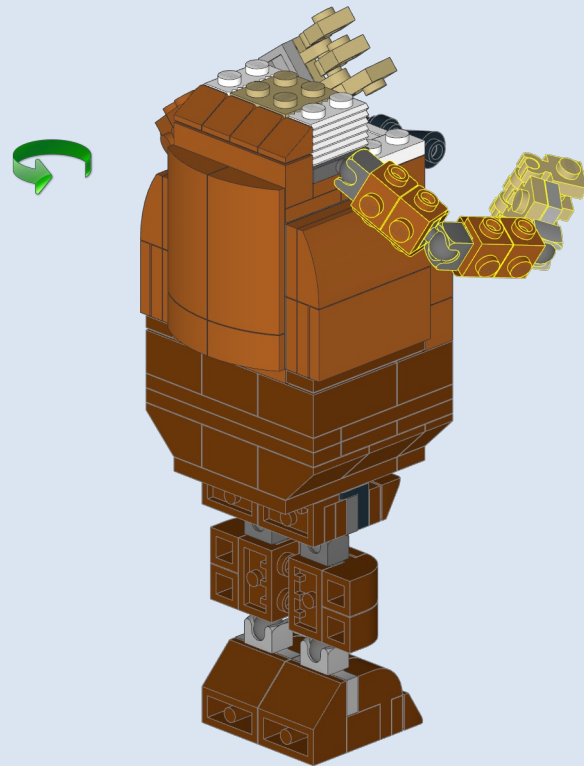

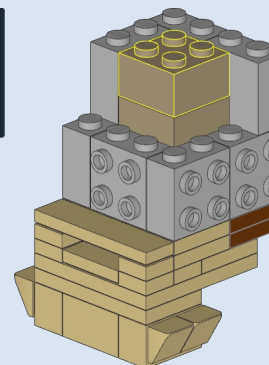
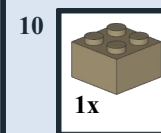
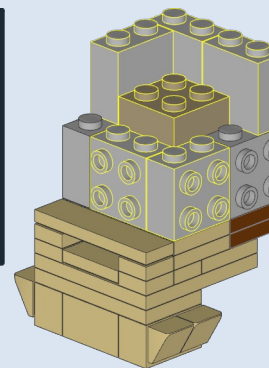
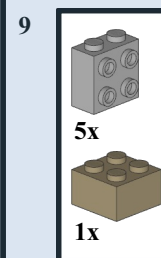
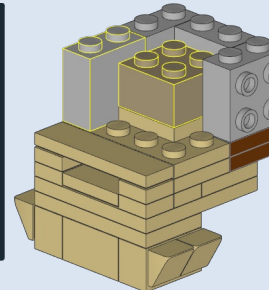
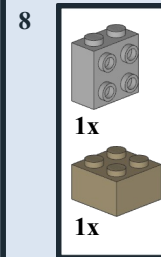
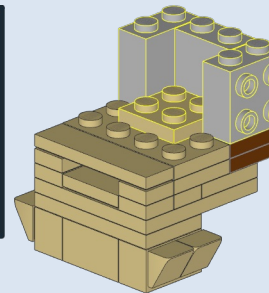
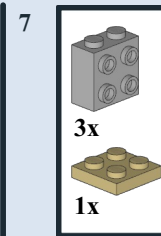
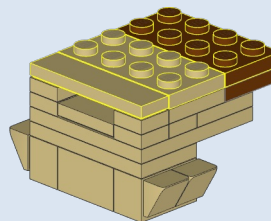
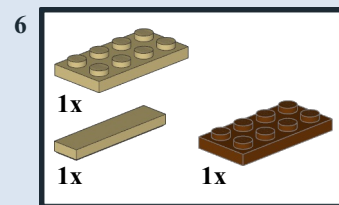
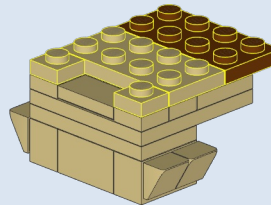
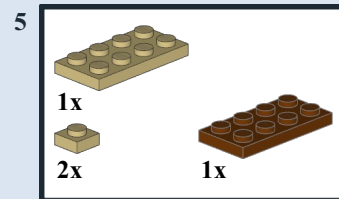
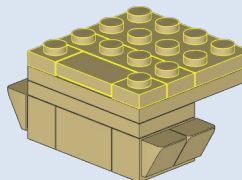
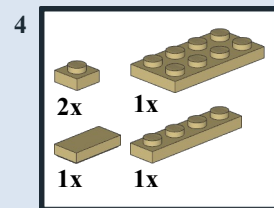
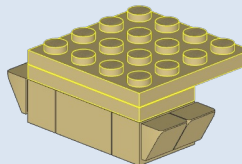
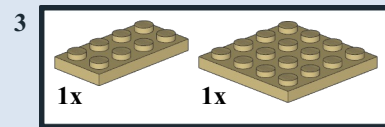
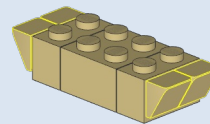
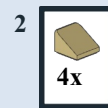
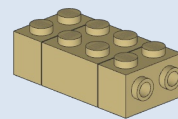
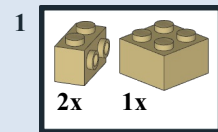

11

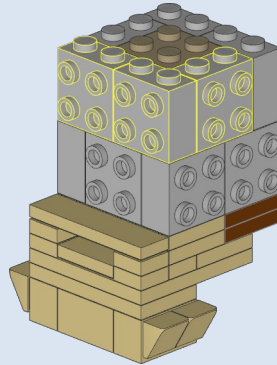
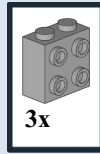

14

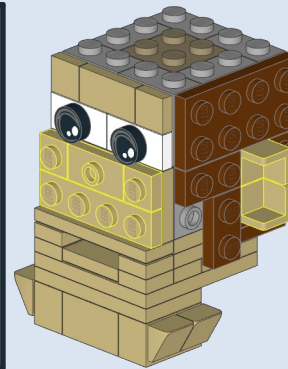
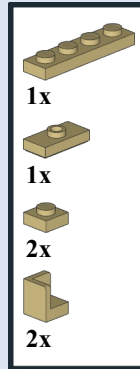

12

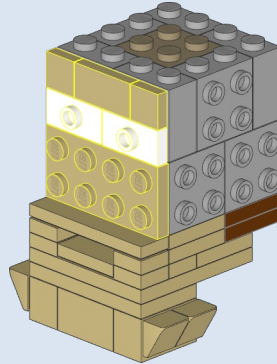
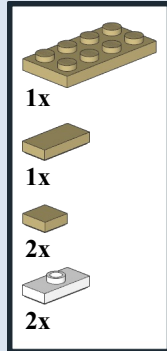

15

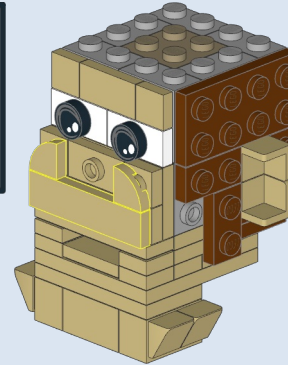
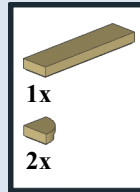

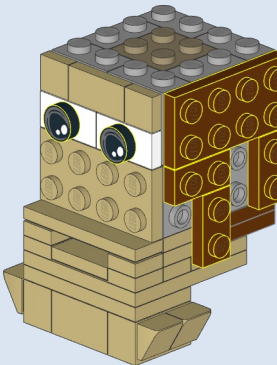
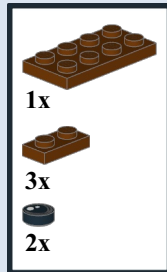

13



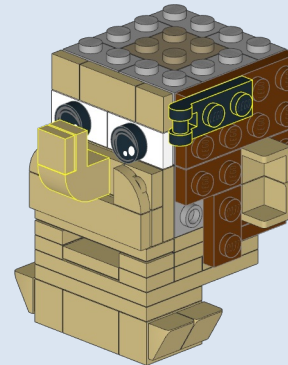
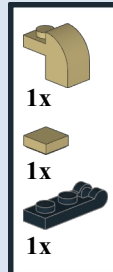

16



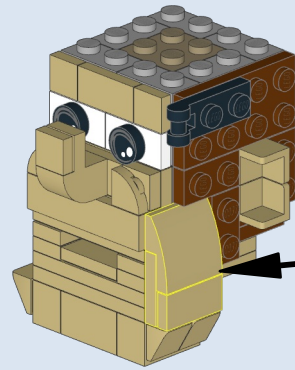

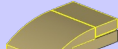
- 17
- 1x 
 - 1x 
 - 1x 

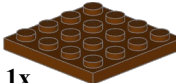



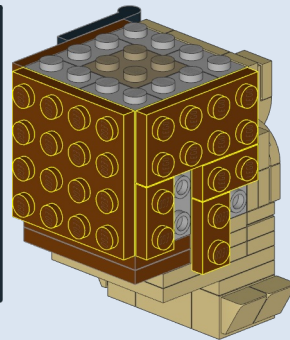

- 1 
- 2 

- 18
- 1x 
 - 1x 
 - 3x 

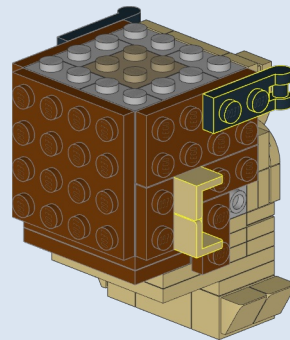





- 19
- 2x 
 - 1x 

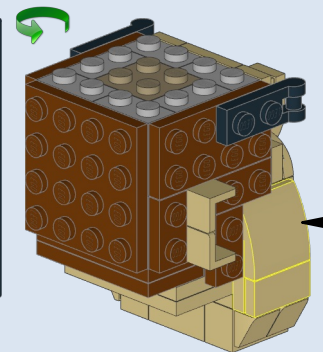

- 20
- 1x 
 - 1x 
 - 1x 



- 1 
- 2 

- 21
- 2x 
 - 2x 

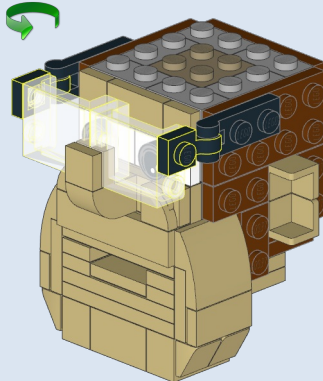

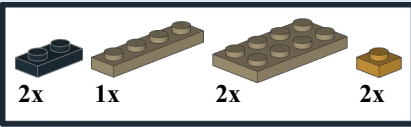
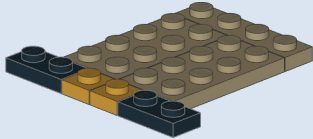
1  

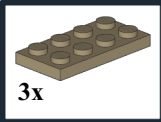
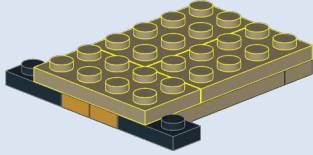
2  

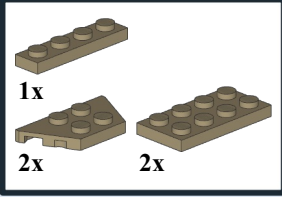
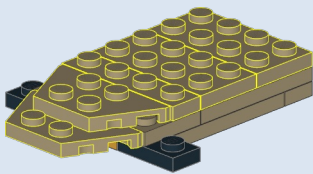
3  

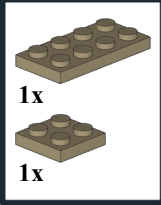
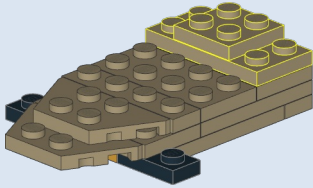
4  

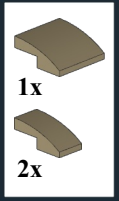
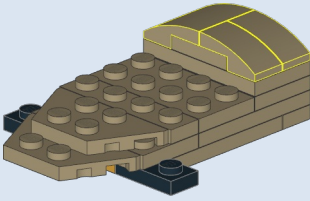
5  

6 