

Light Sabre Blue

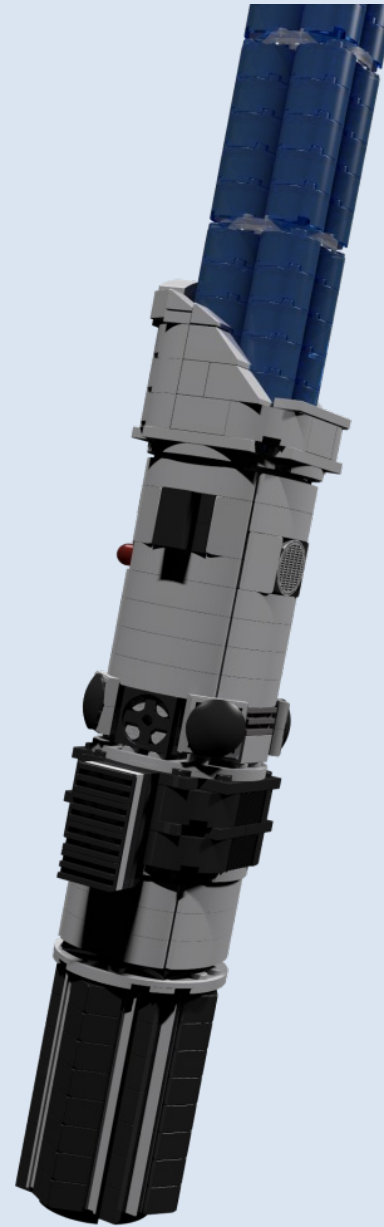

Designed by
LEGOMan/Bo Jensen

INSTRUCTION BY
KNUD ALBRECHTSEN
www.snakebyte.dk/lego

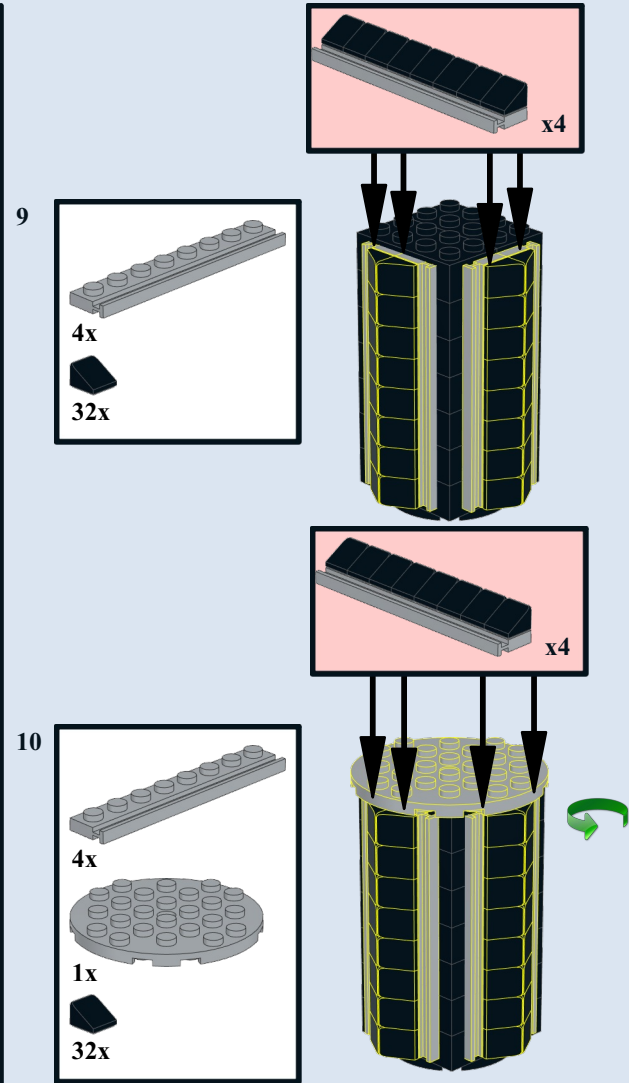
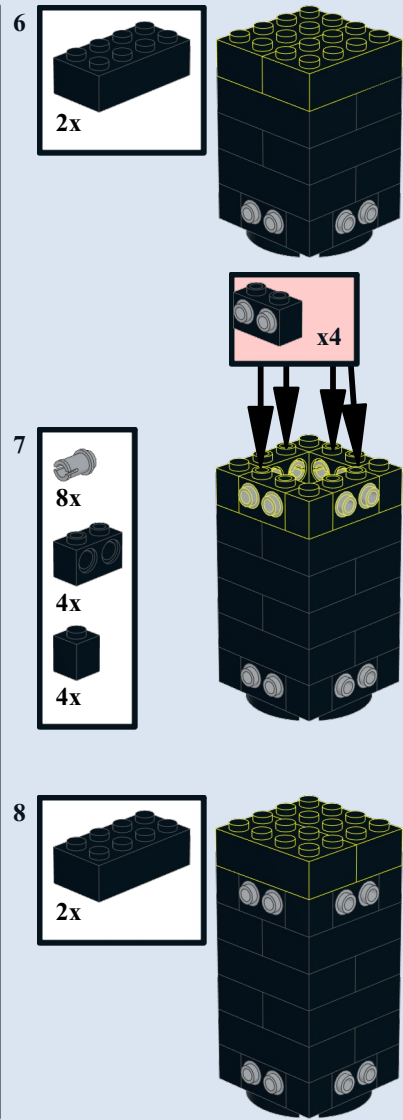
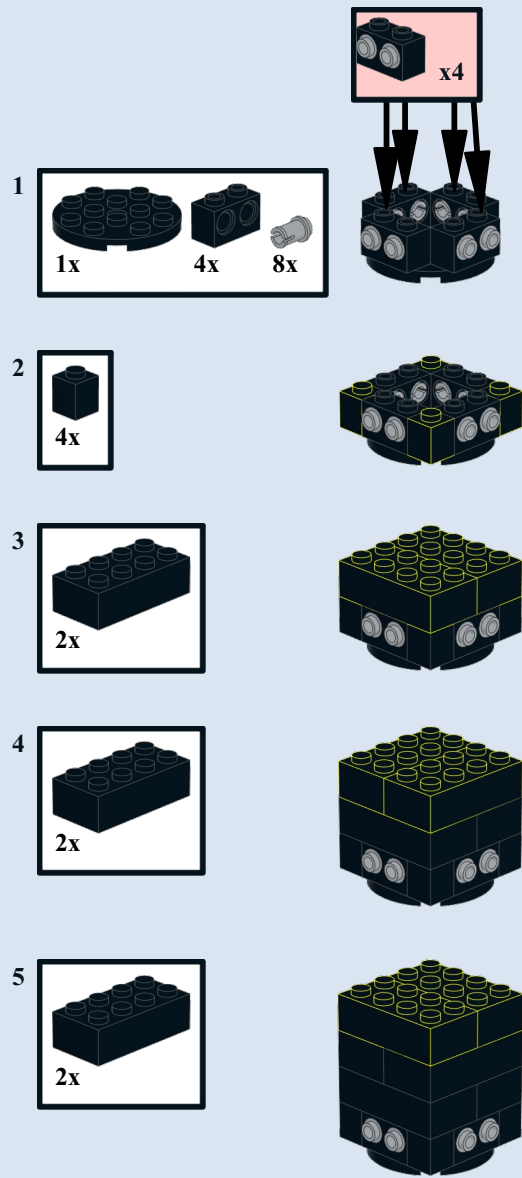

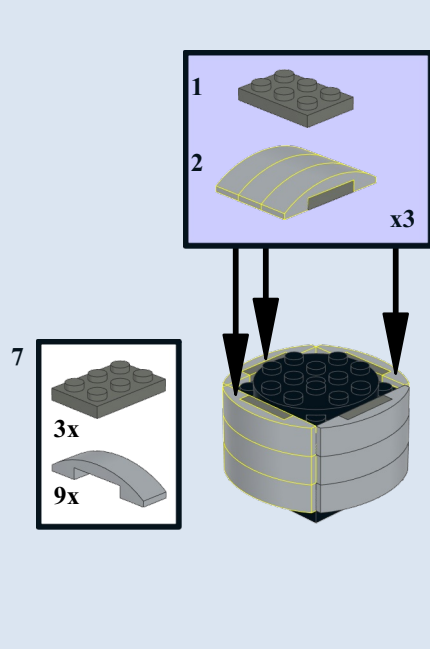
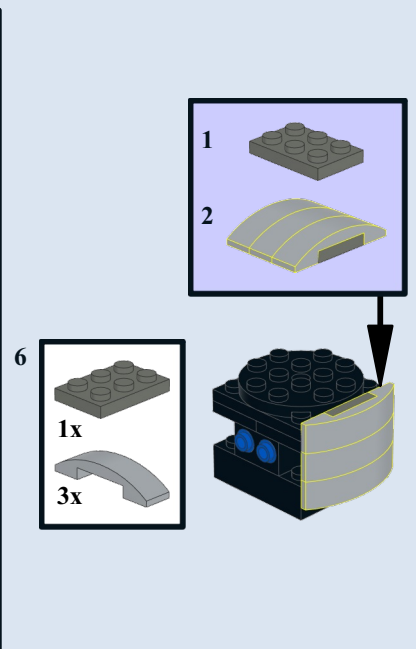
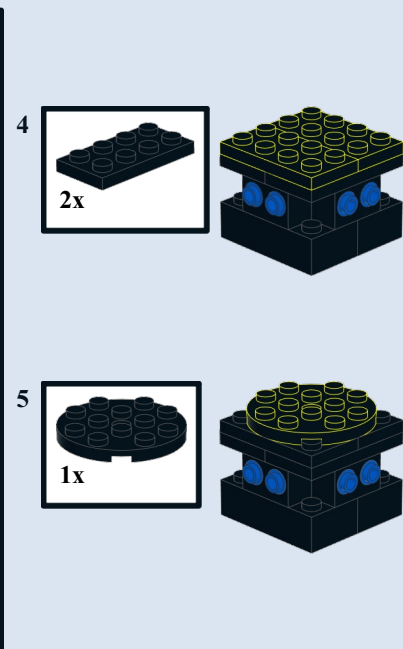
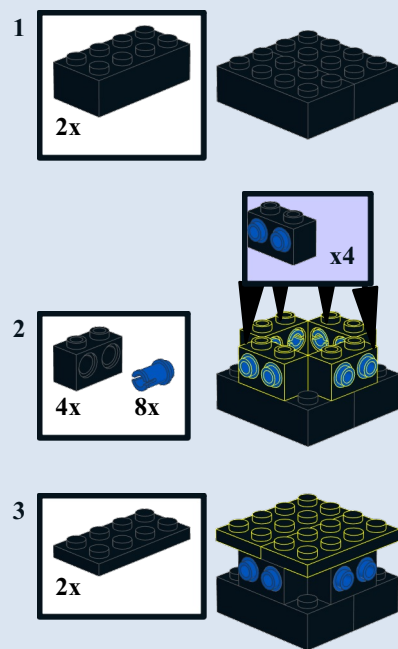

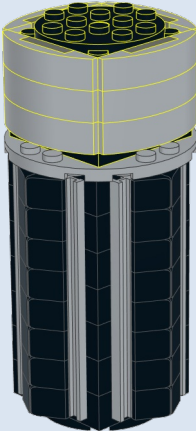

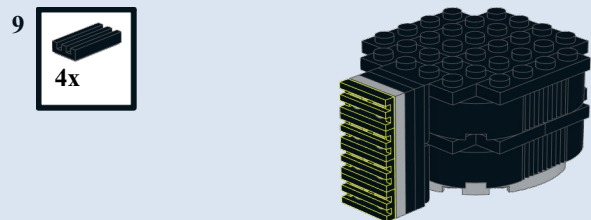
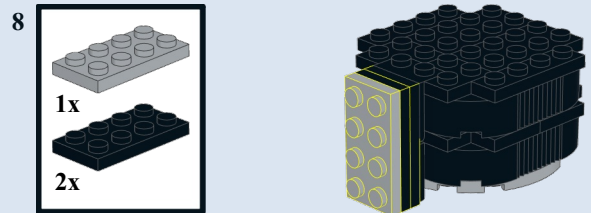
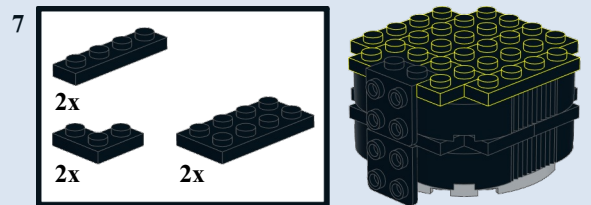
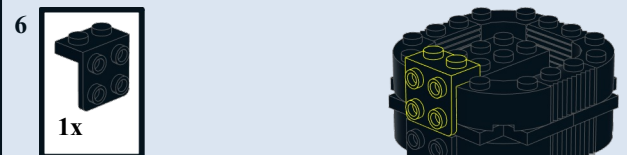
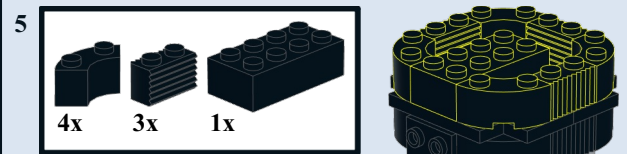
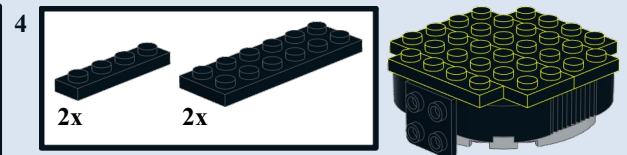
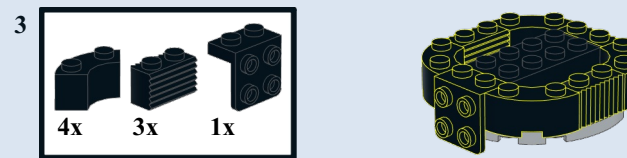
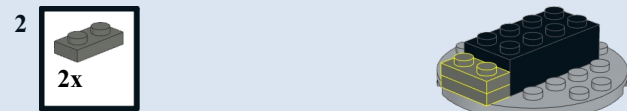
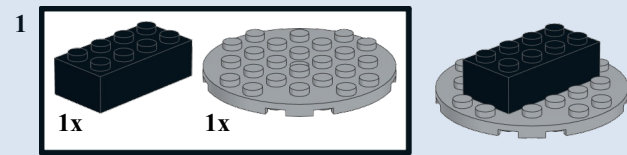

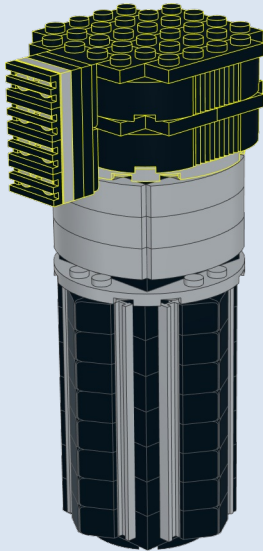

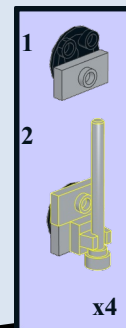
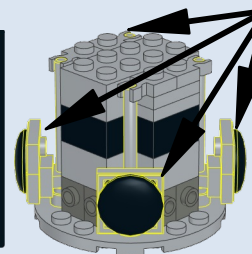
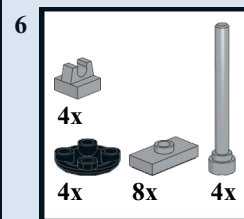
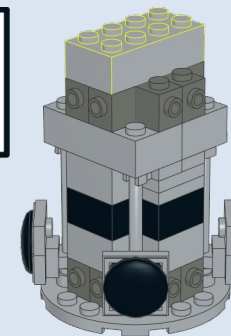
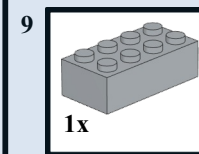
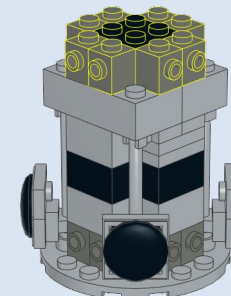
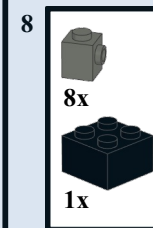
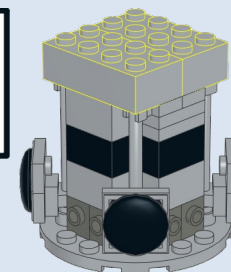
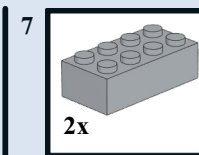
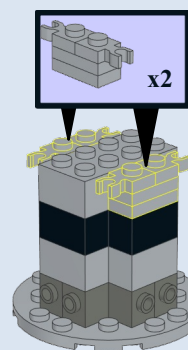
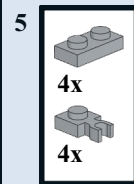
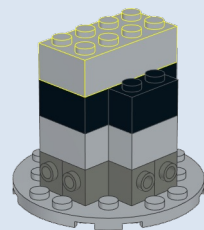
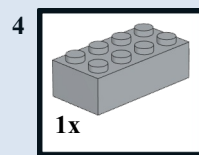
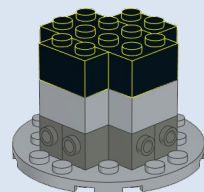
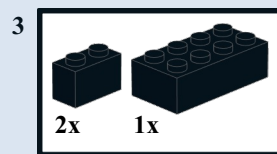
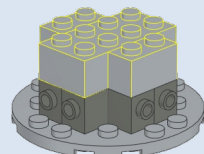
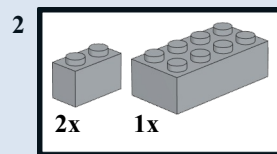
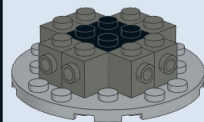
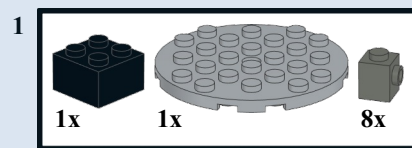

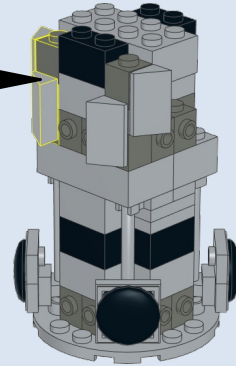
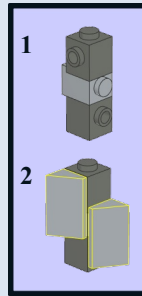
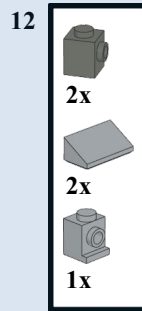
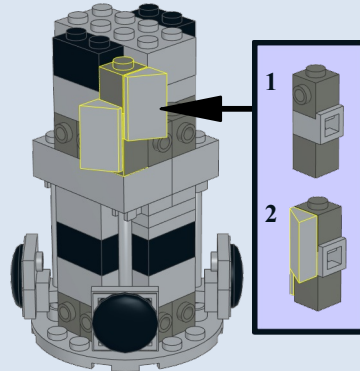
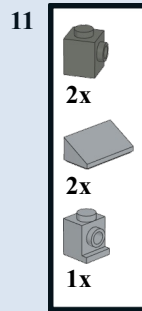
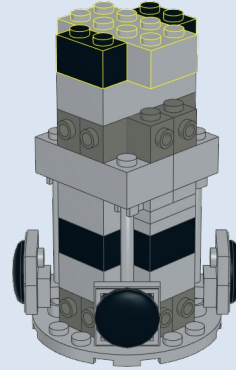
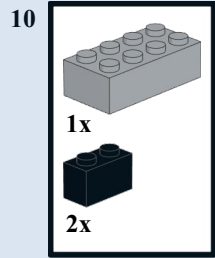

- 13
- 1x
 - 1x
 - 1x
 - 1x
 - 2x

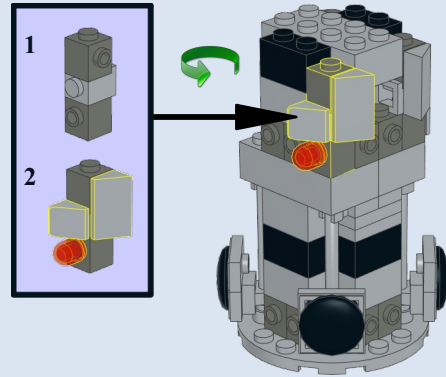

- 16
- 1x

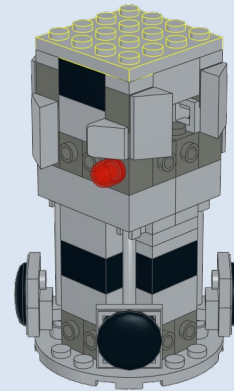

- 14
- 2x
 - 2x
 - 1x

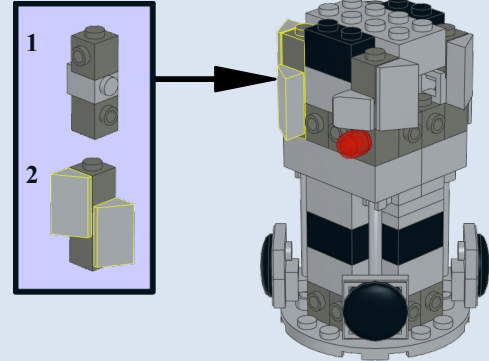

- 17
- 2x

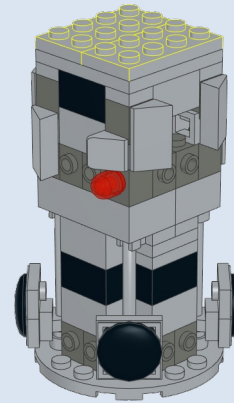

- 15
- 4x

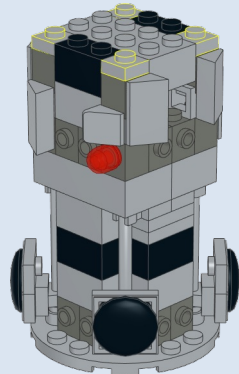

- 18
- 1x
 - 6x
 - 1x
 - 1x
 - 1x

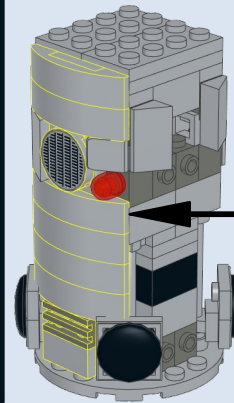

- 1
-
- 2
-
- 3
-
- Diagram for step 18 showing three grey 1x12 plates with holes being placed on top of the robot's head. The first plate (1) is shown with a hole, the second (2) and third (3) are shown with yellow lines indicating the placement of the plates.

19

- 6x
- 1x
- 1x
- 2x
- 2x
- 1x

- 1
- 2
- 3
- 4

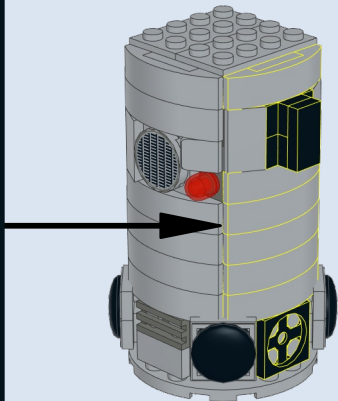

20

- 6x
- 1x
- 1x
- 1x
- 1x

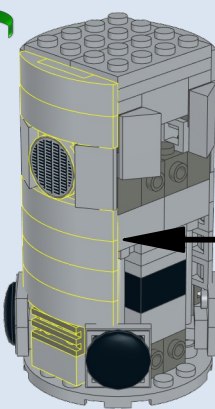

- 1
- 2
- 3

21

- 6x
- 1x
- 1x
- 1x
- 1x
- 1x
- 1x
- 1x

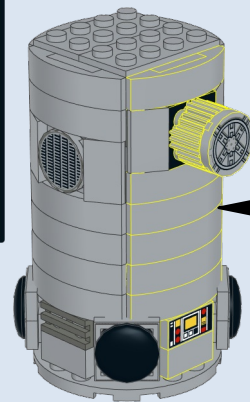

- 1
- 2
- 3
- 4

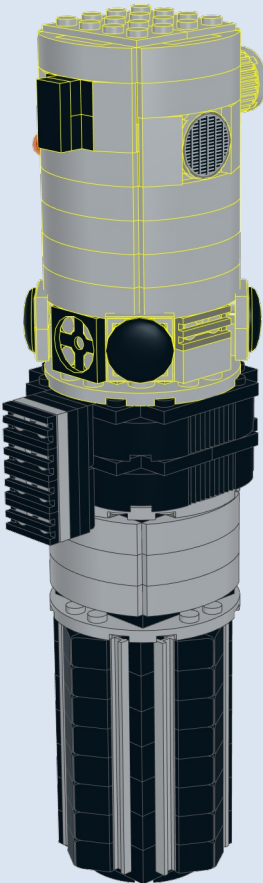

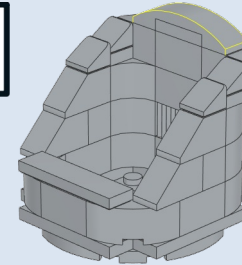
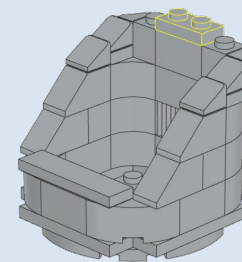
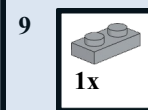
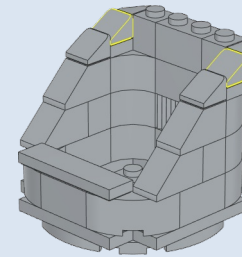
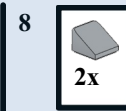
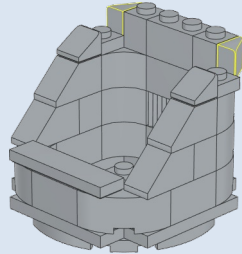
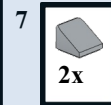
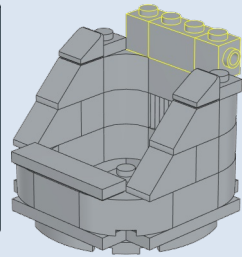
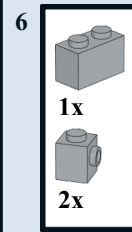
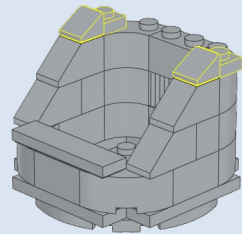
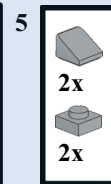
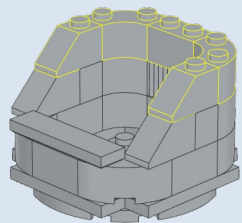
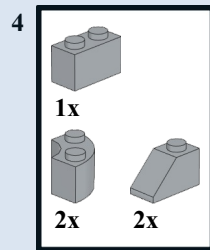
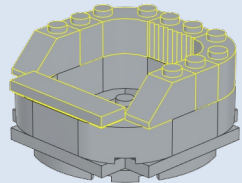
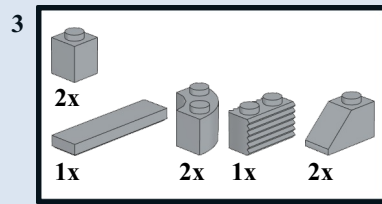
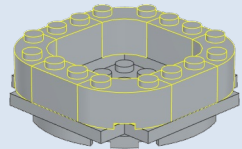
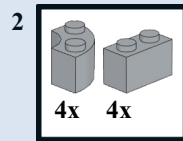
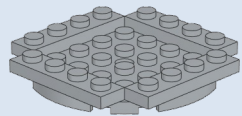
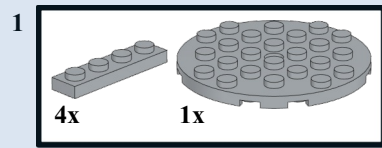

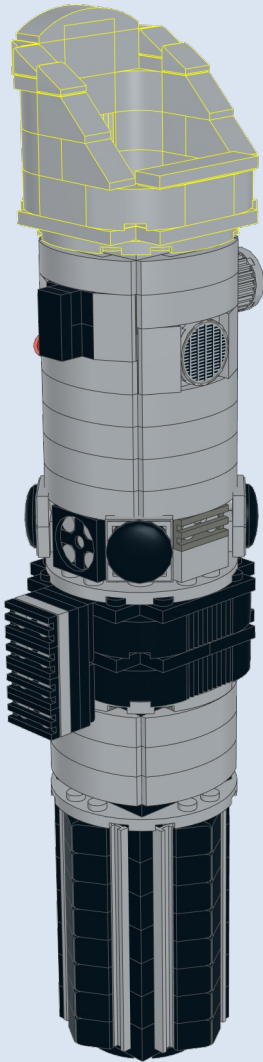

15

