

AB4ue-35 DRG Passenger Car 2. Class

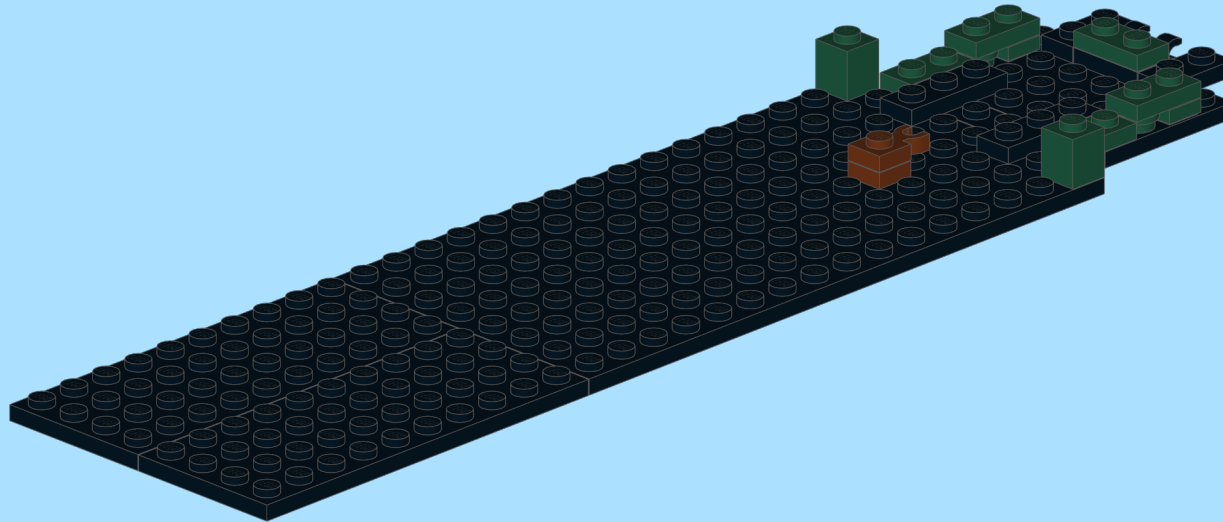

Design By: Filip Pienkowski

INSTRUCTION BY
KNUD ALBRECHTSEN
www.snakebyte.dk/lego

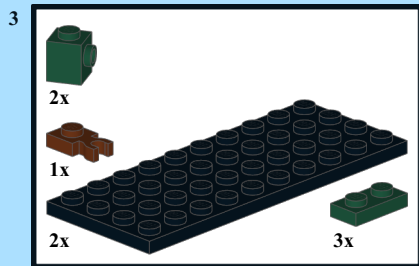
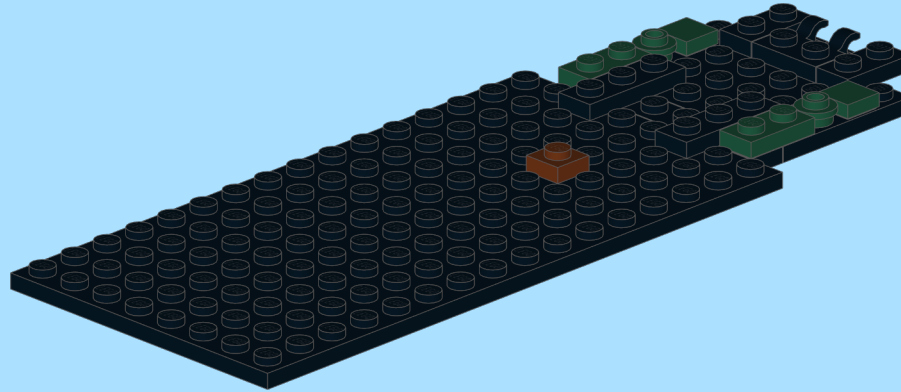
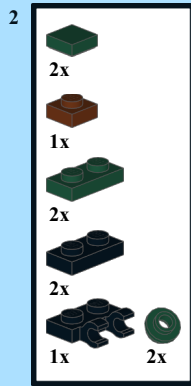
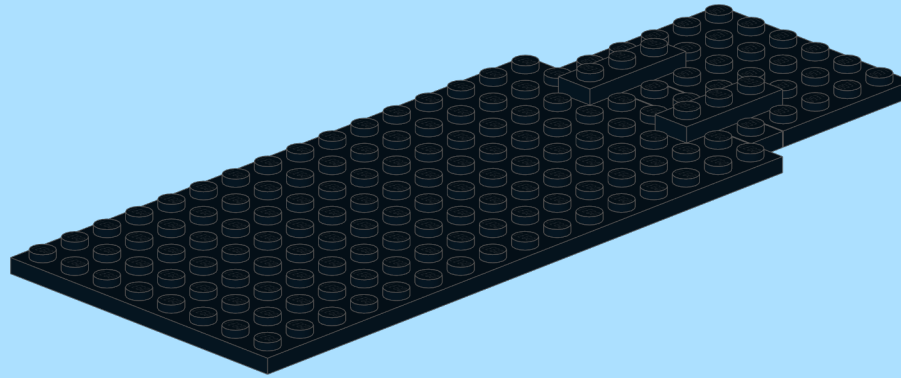
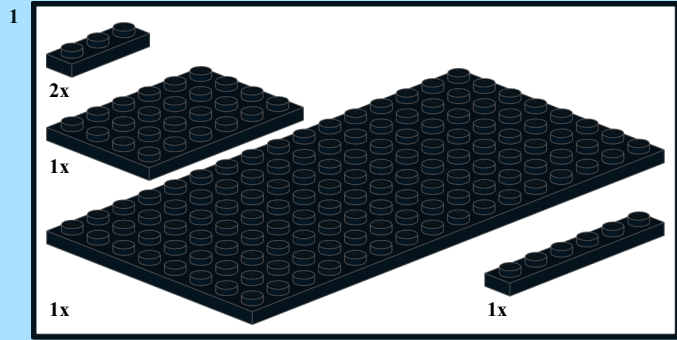



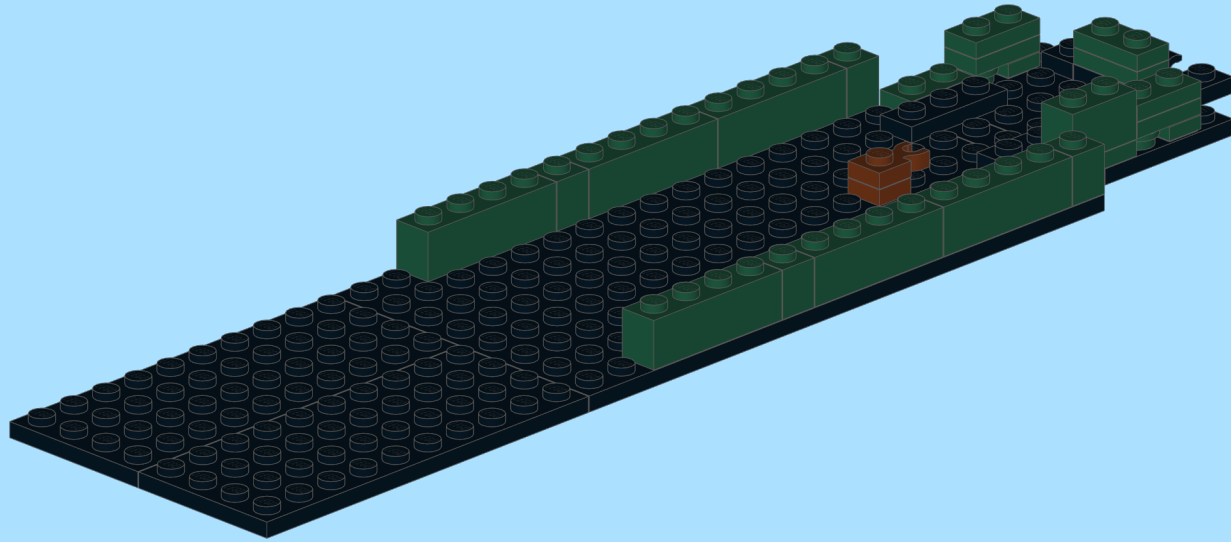
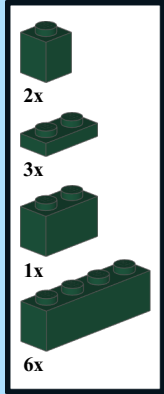



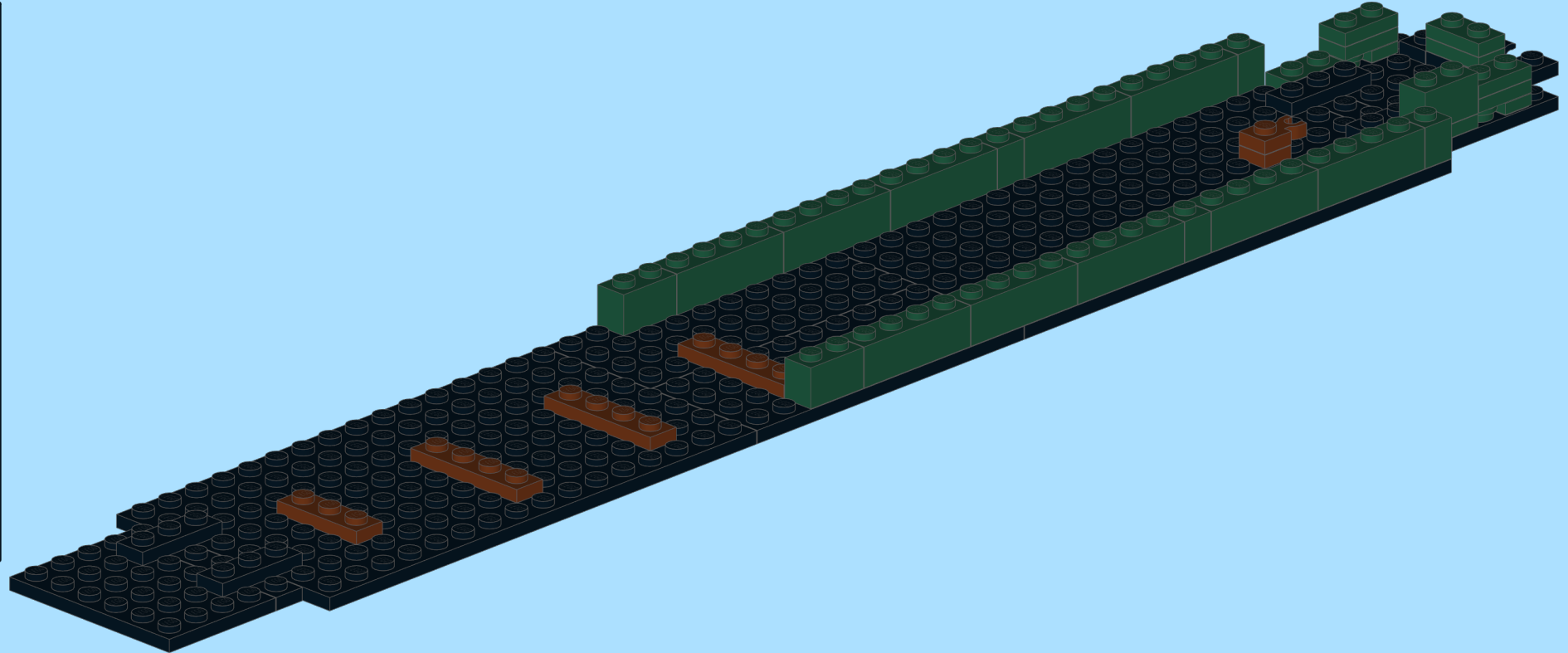
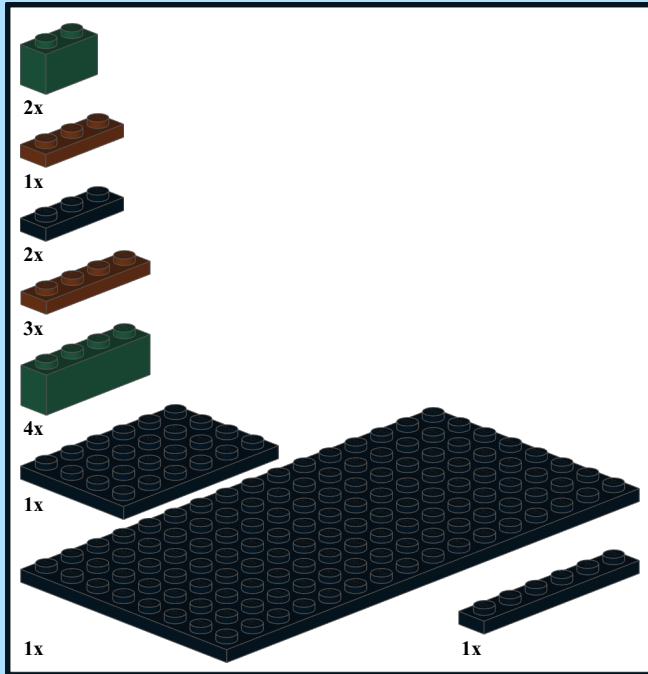





4



5







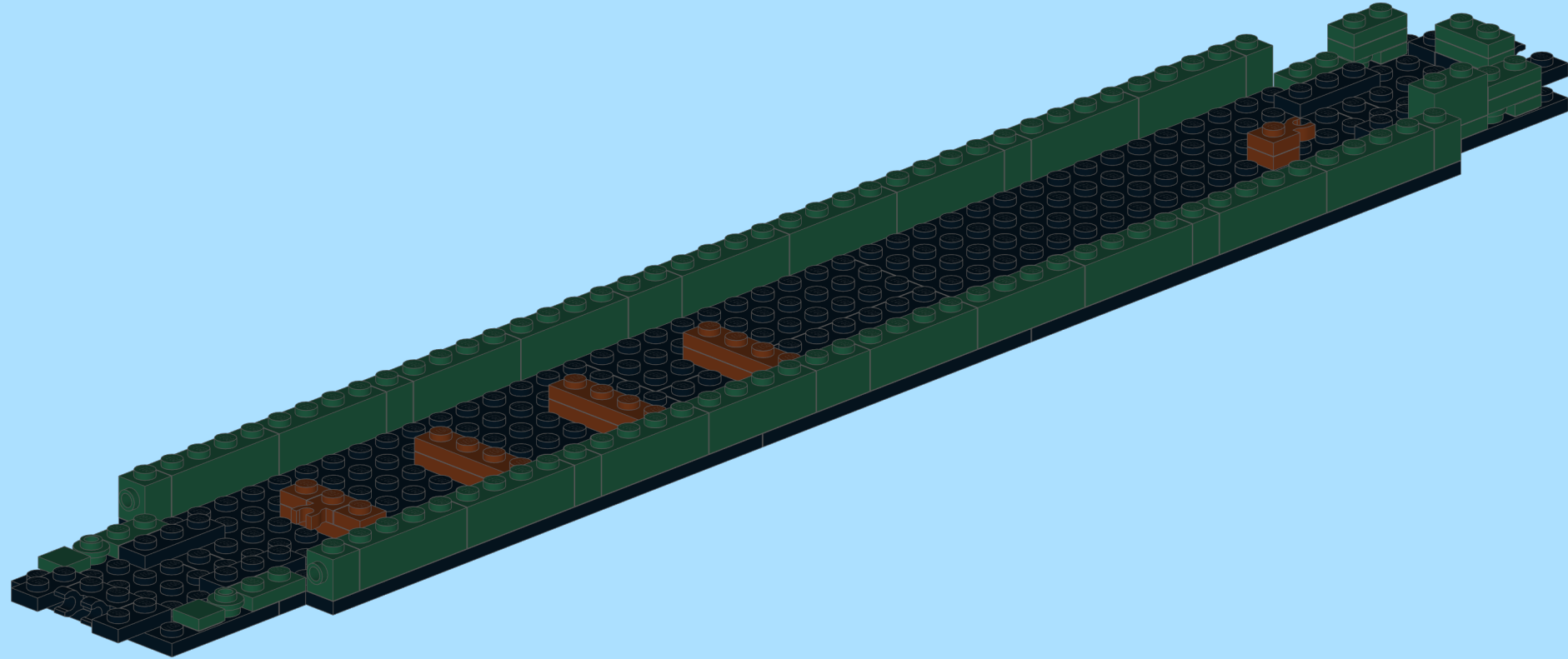





6

-  2x
-  2x
-  1x
-  2x
-  2x
-  1x
-  2x
-  3x
-  2x
-  8x
-  2x
-  2x



7

-  2x
-  1x
-  2x
-  1x
-  1x
-  4x
-  4x
-  7x
-  2x
-  5x

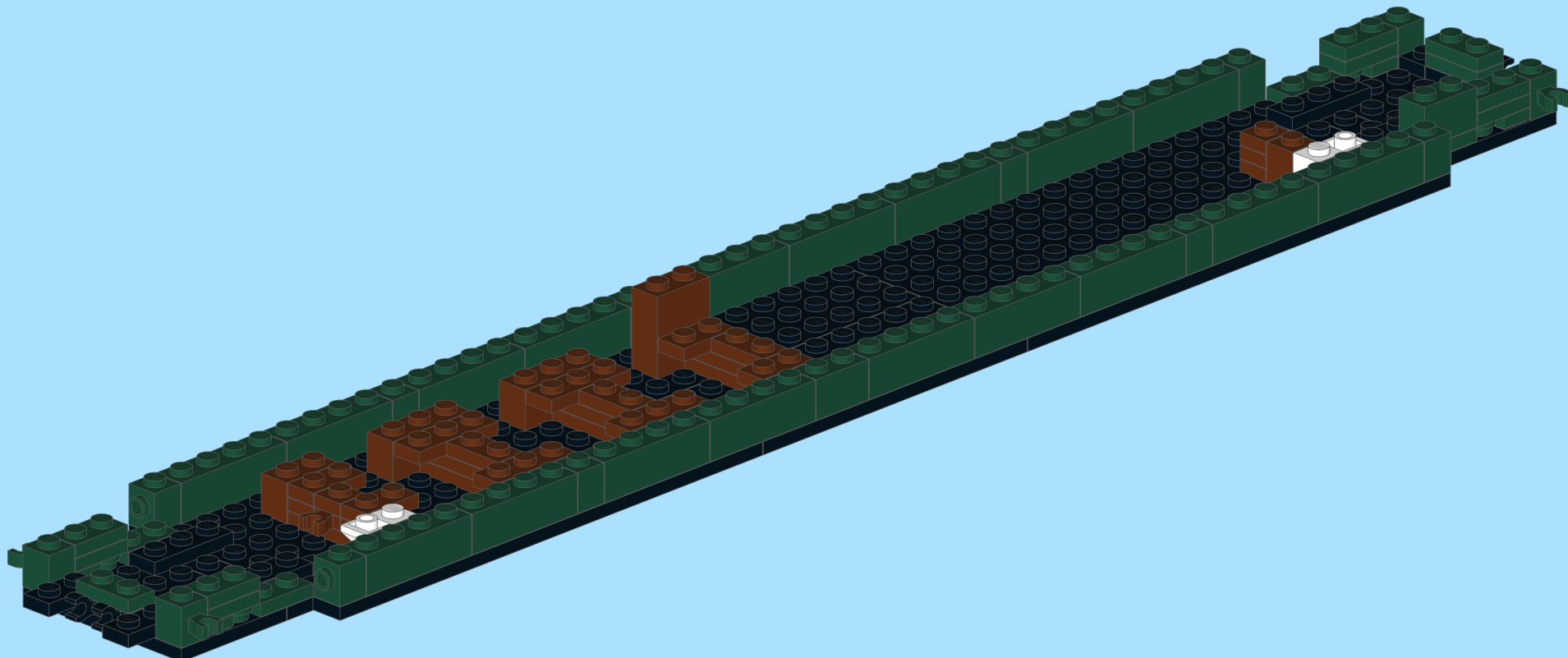

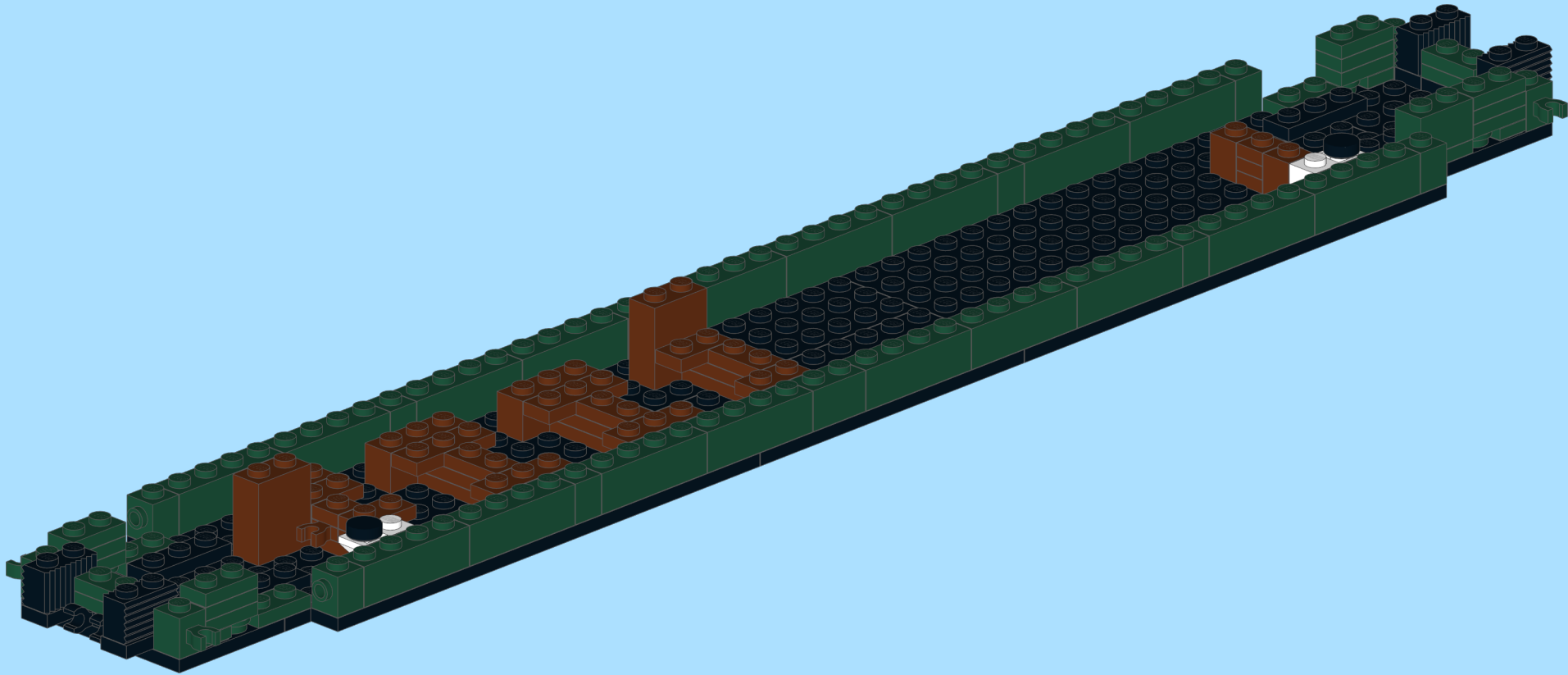
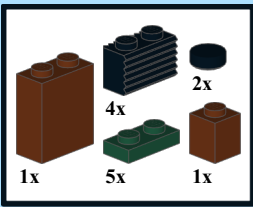

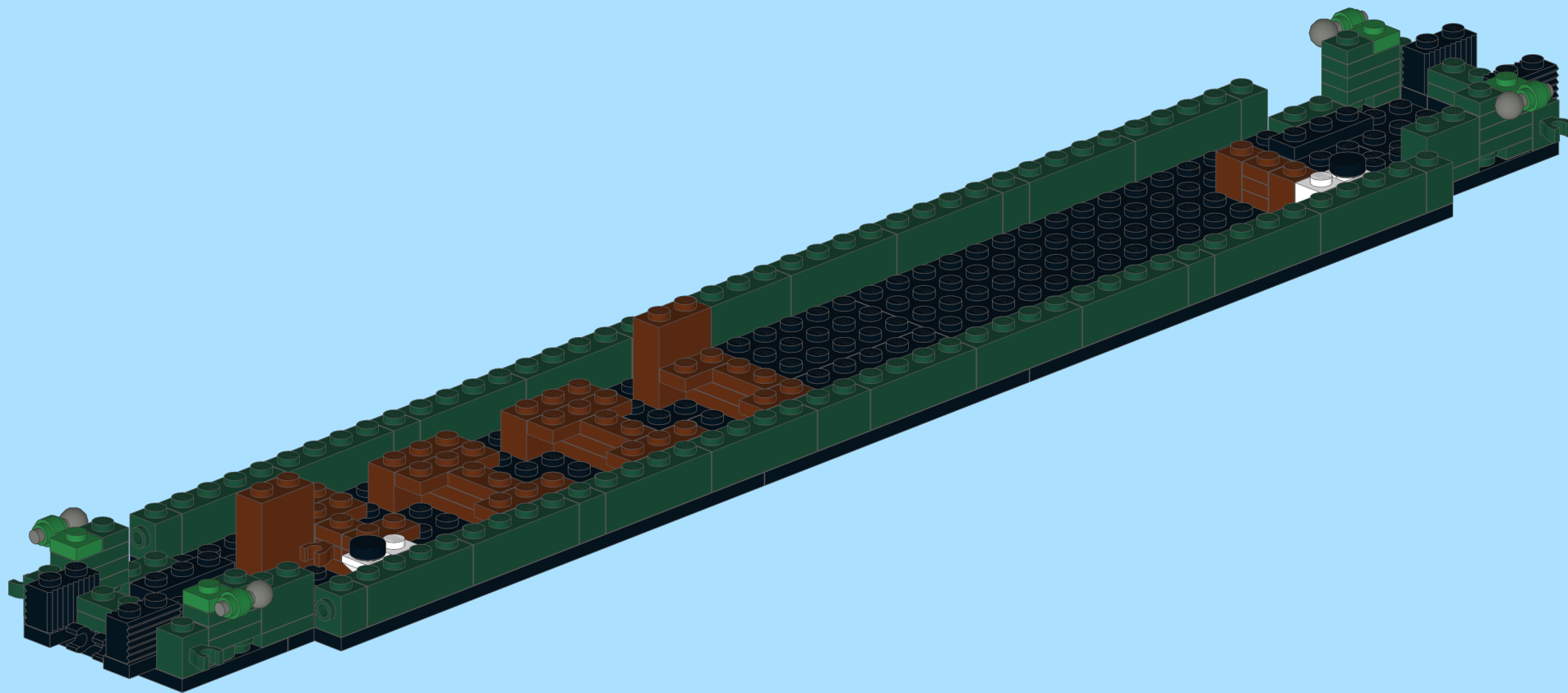
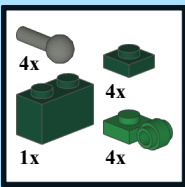

- 4x
- 4x
- 4x
- 1x

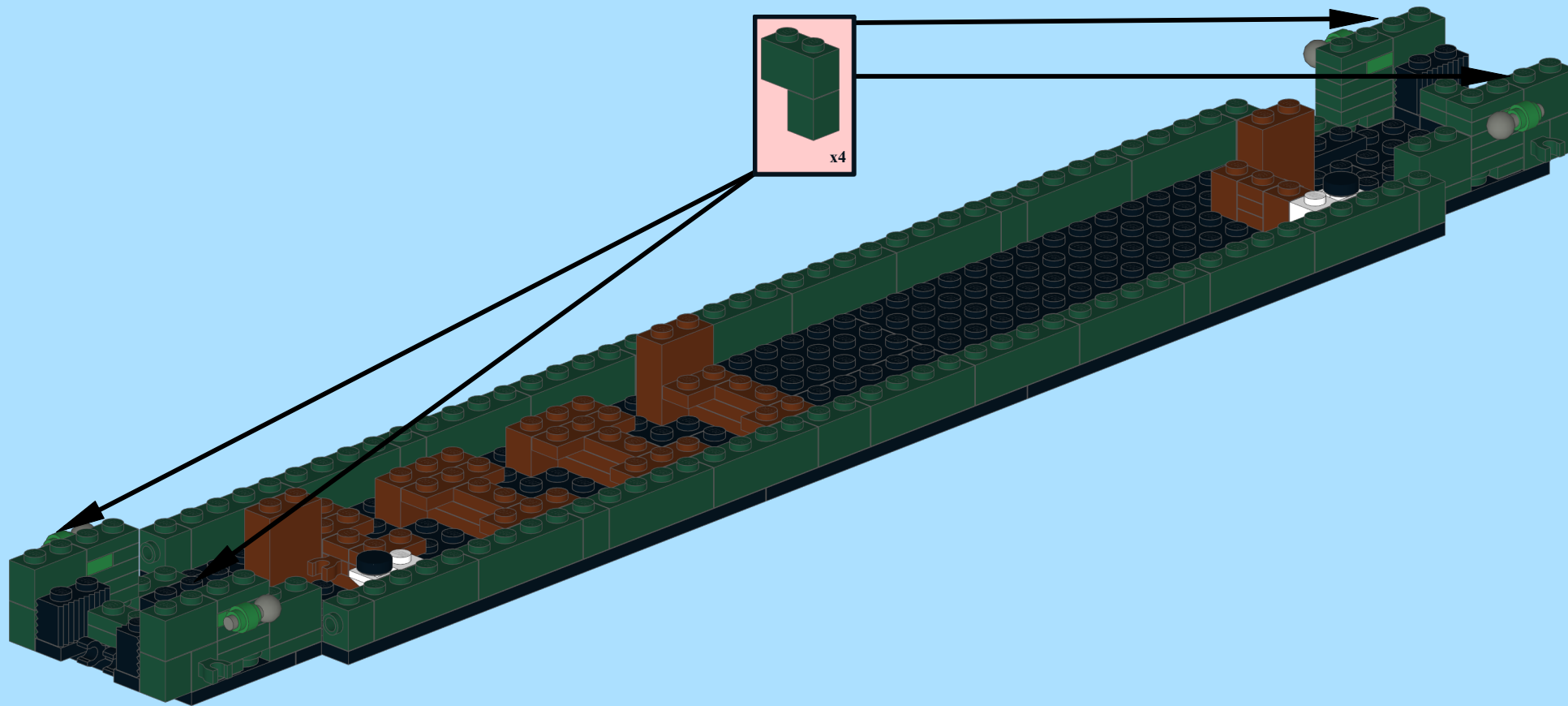

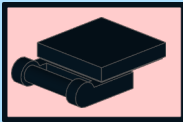
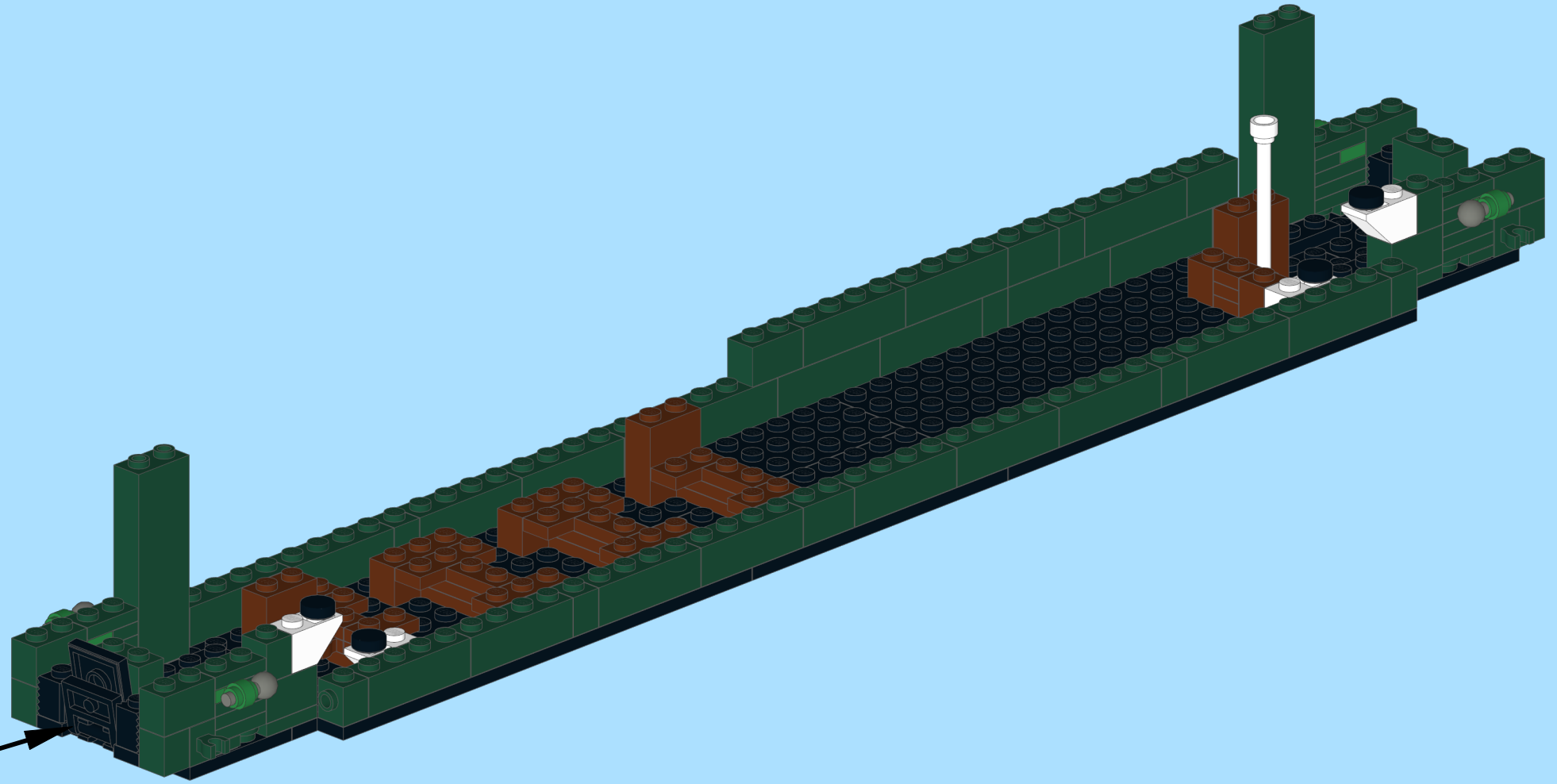
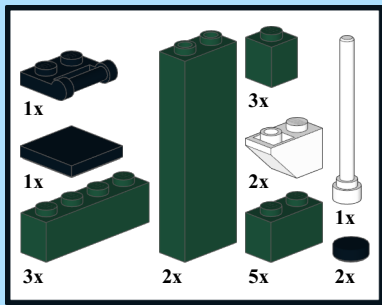

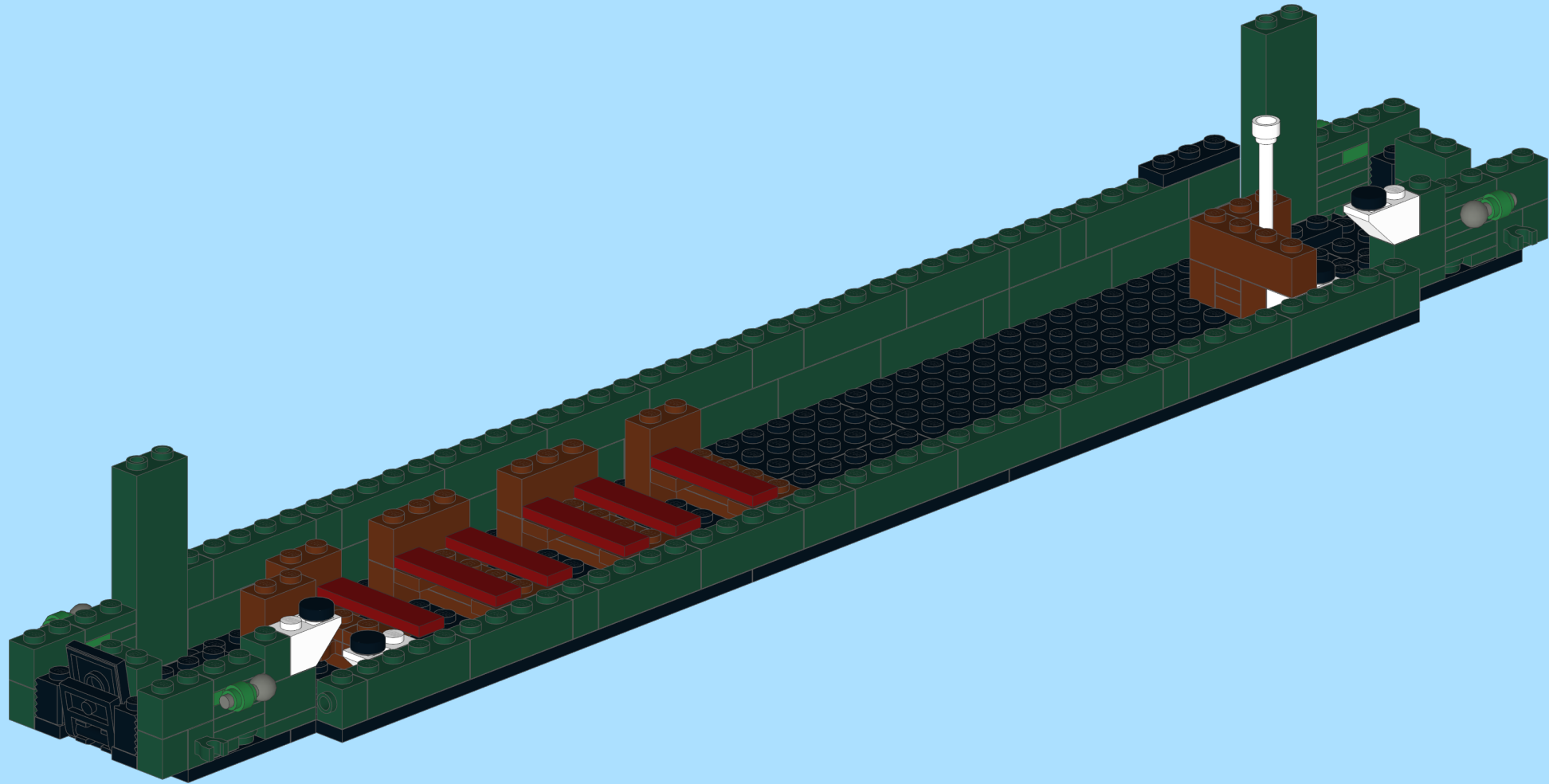
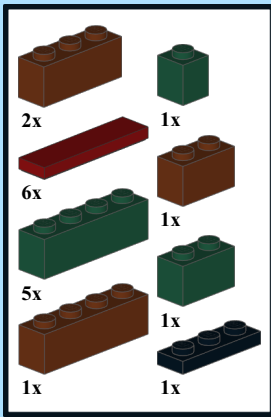

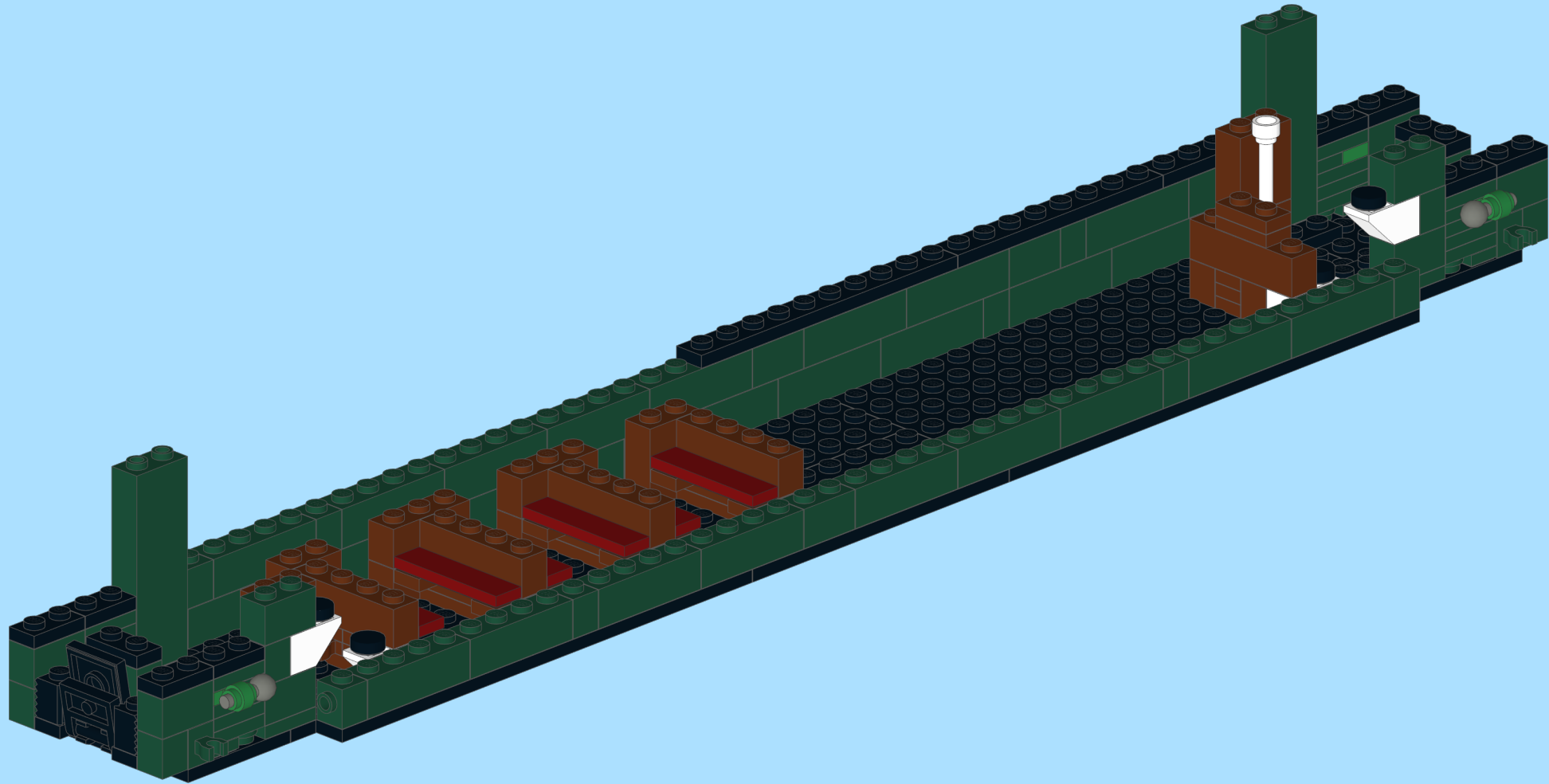
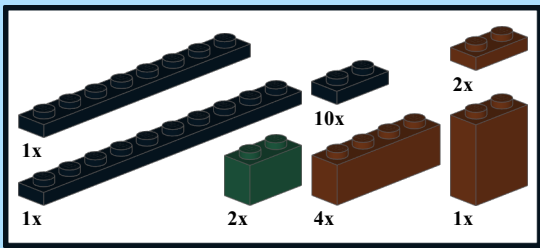

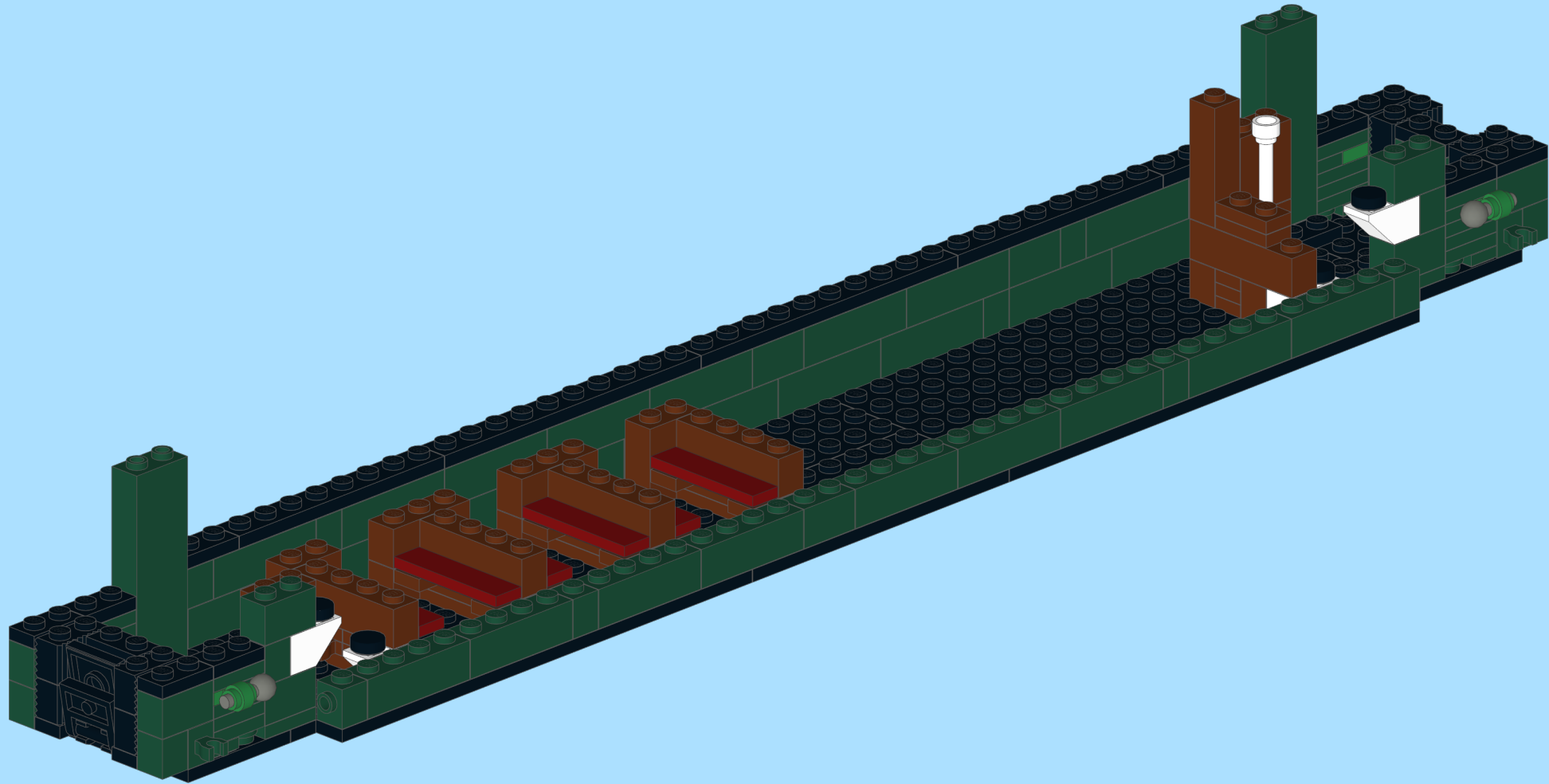
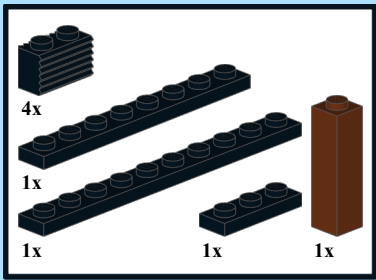

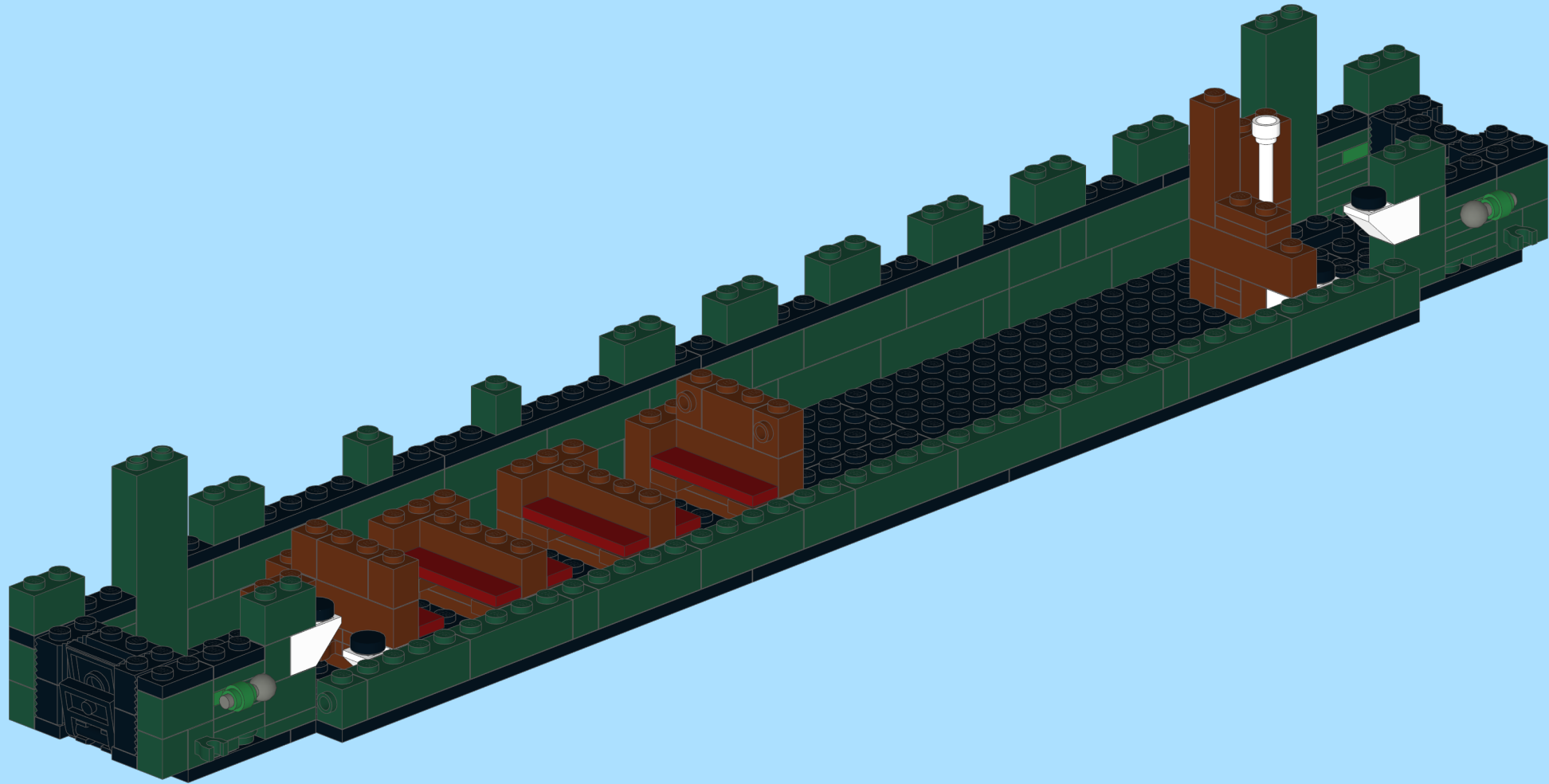
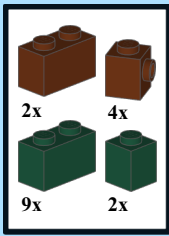

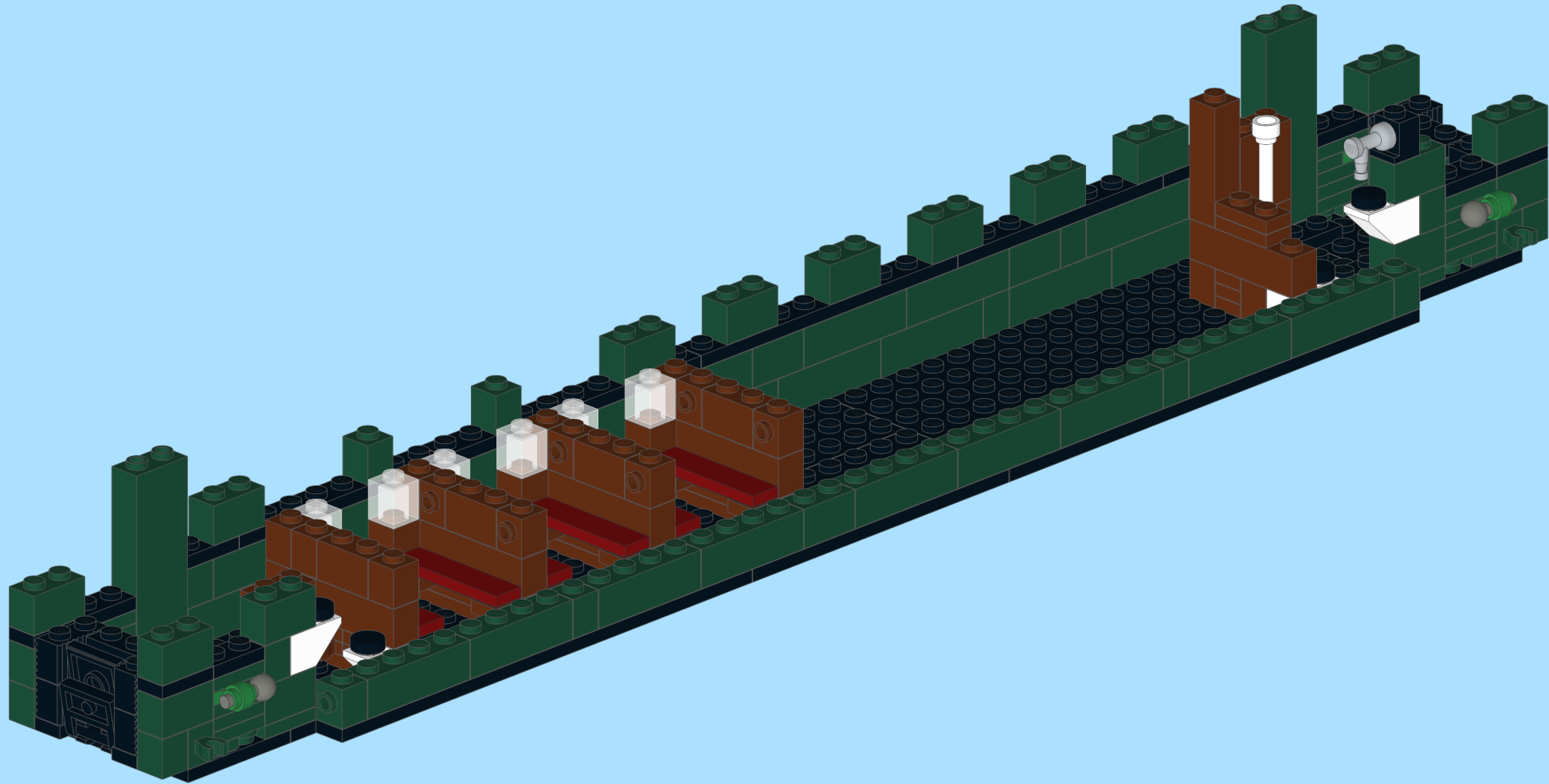

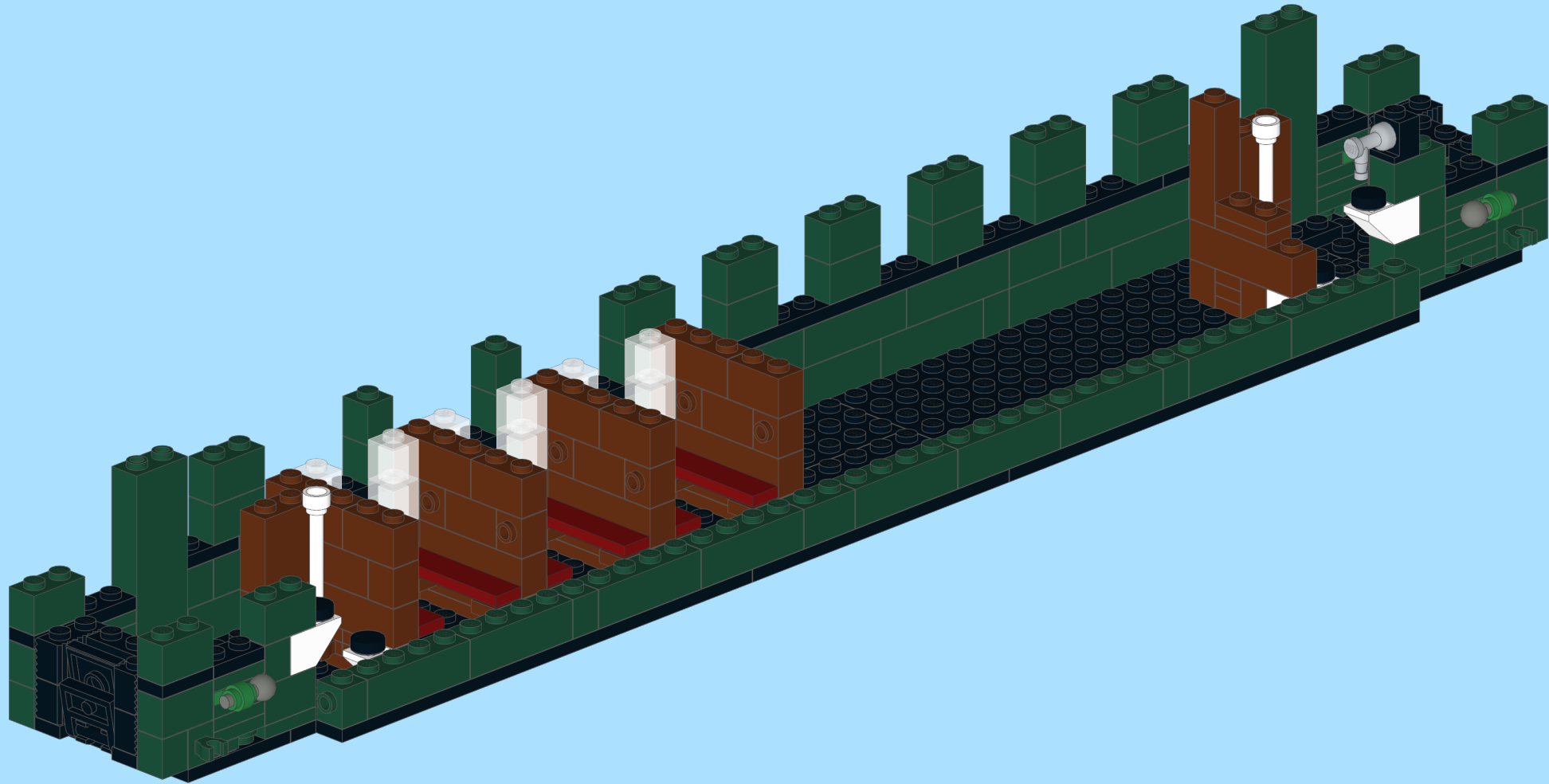
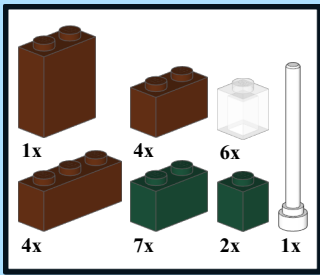

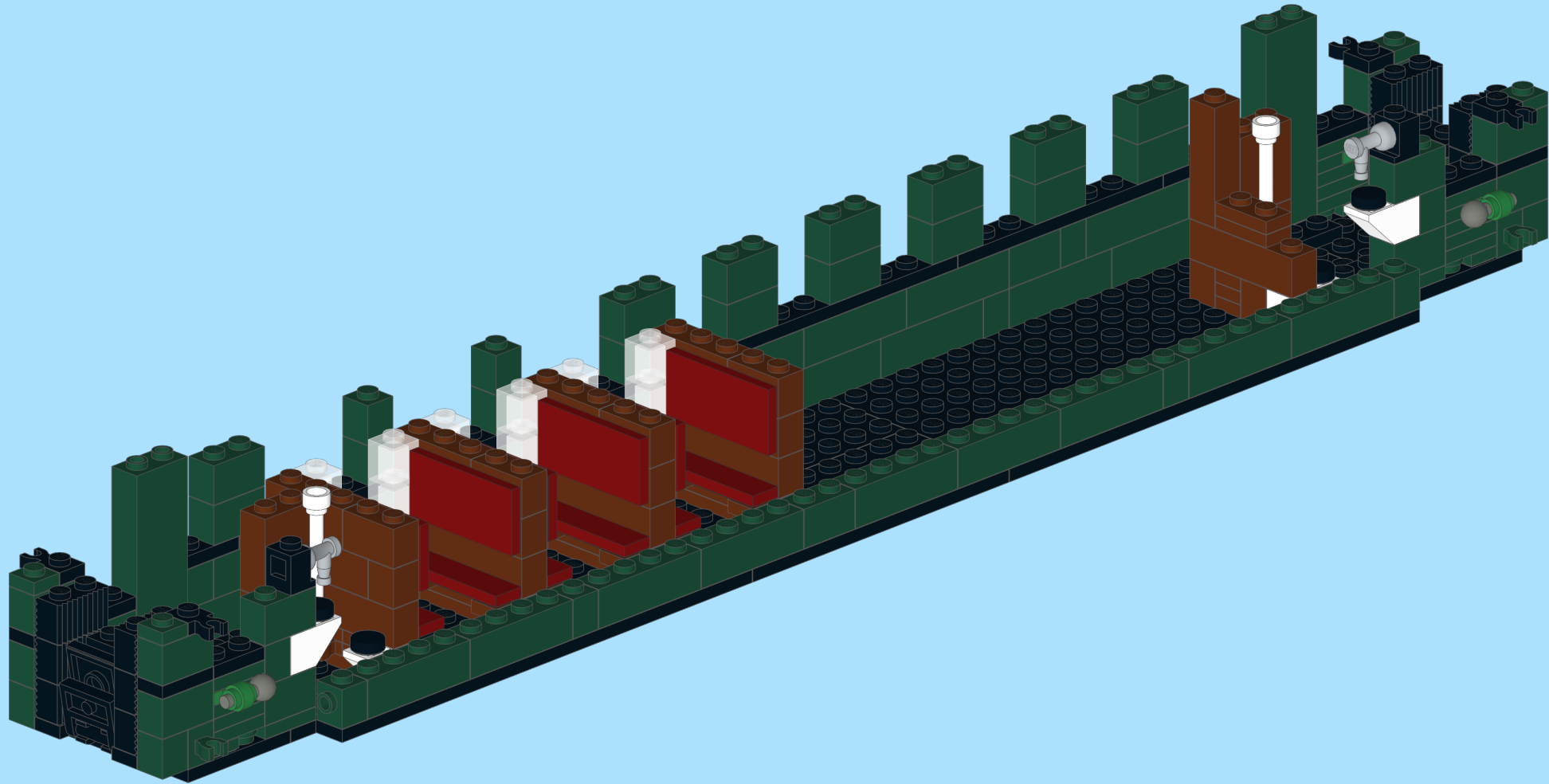
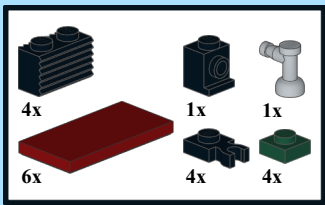

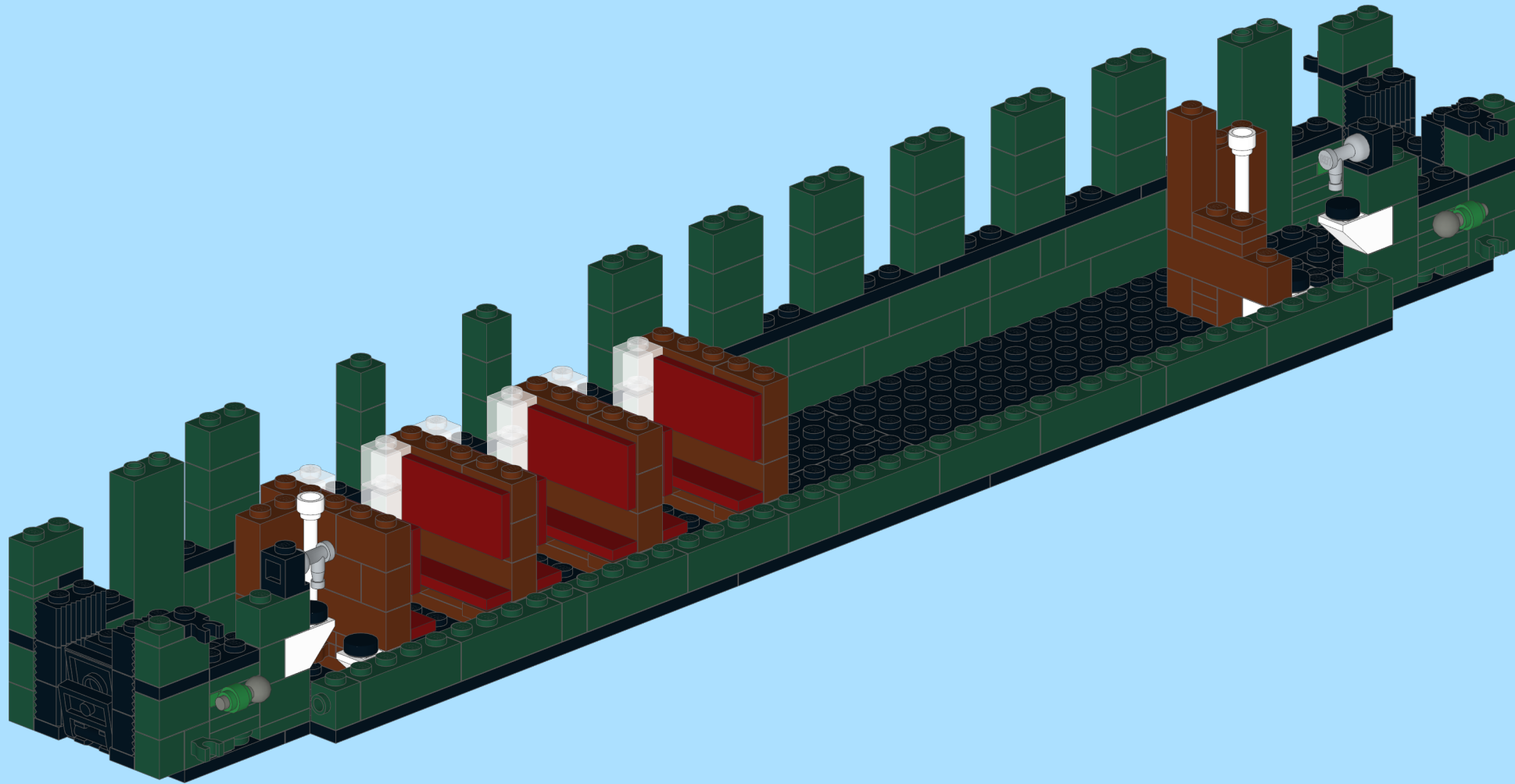
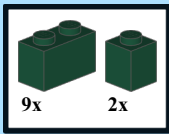

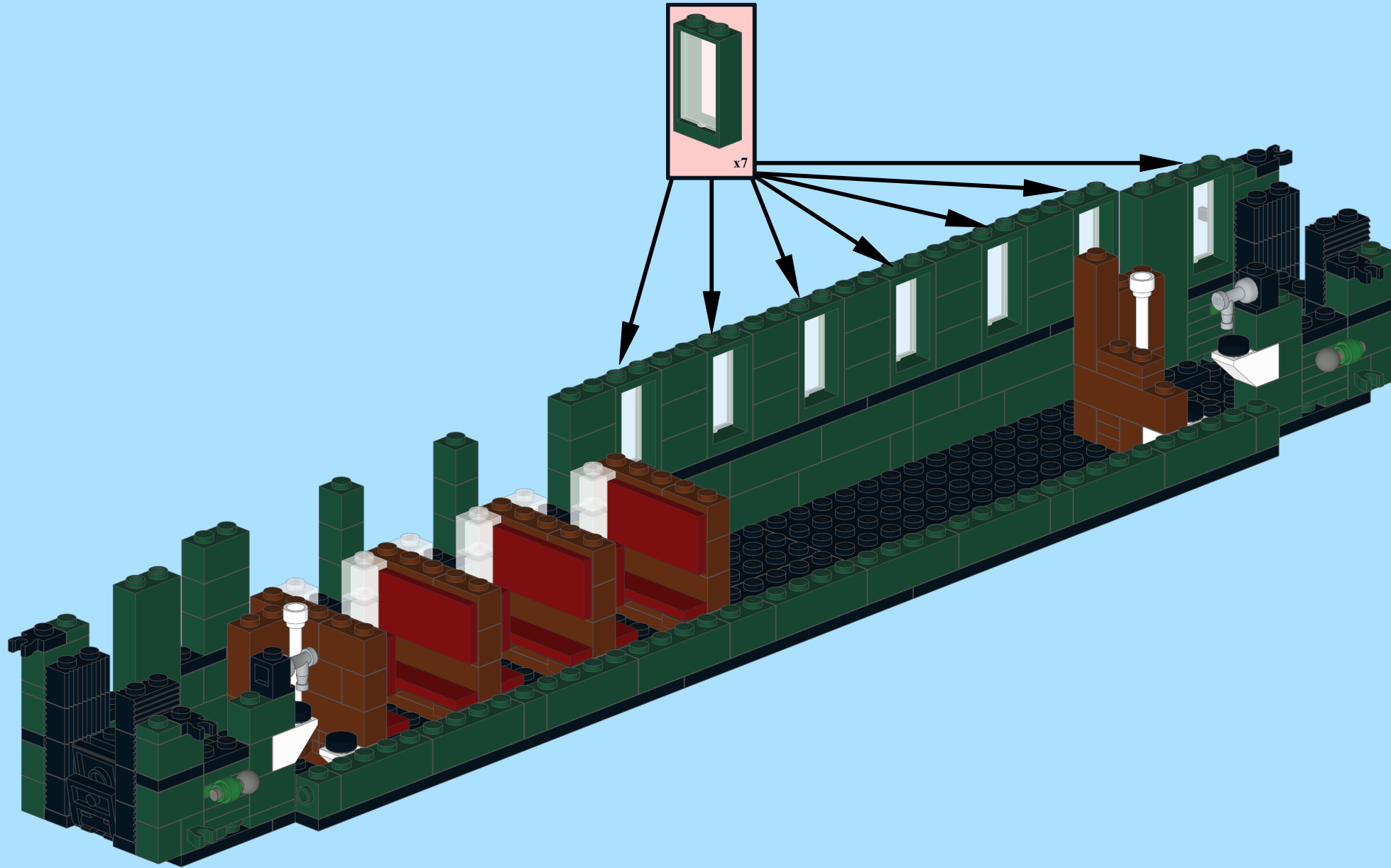
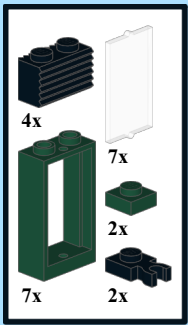

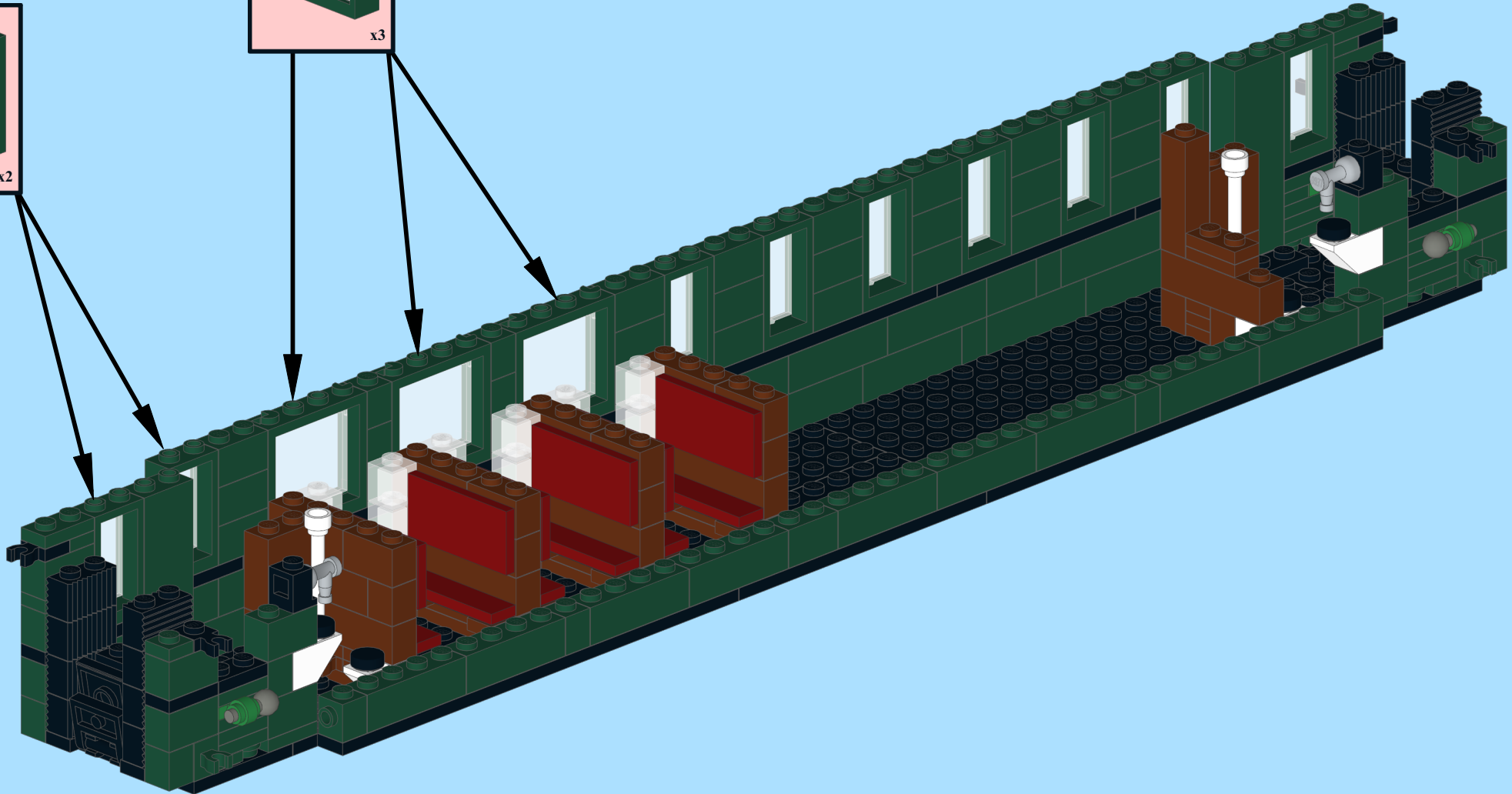
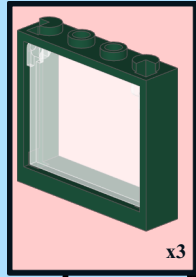
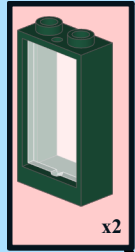
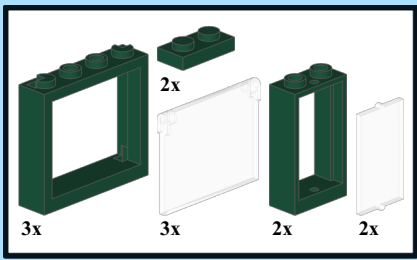

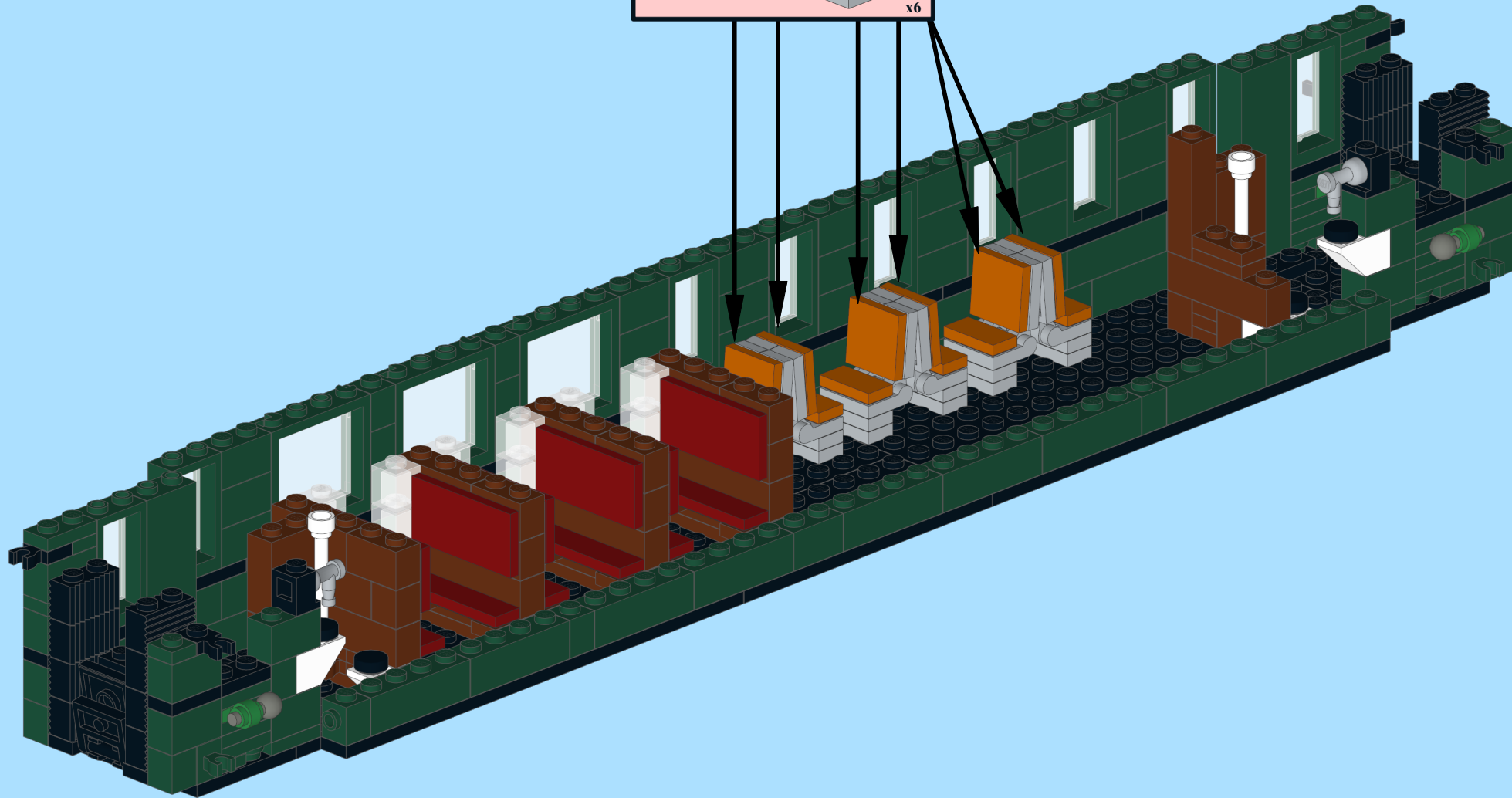
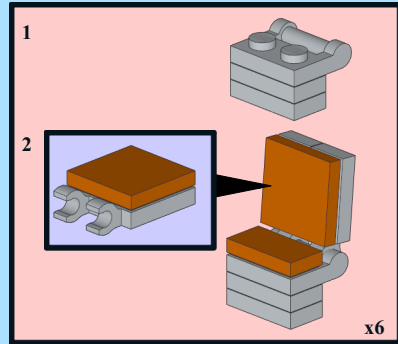
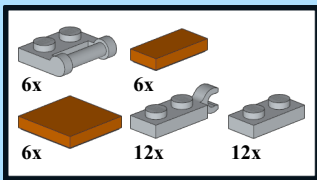

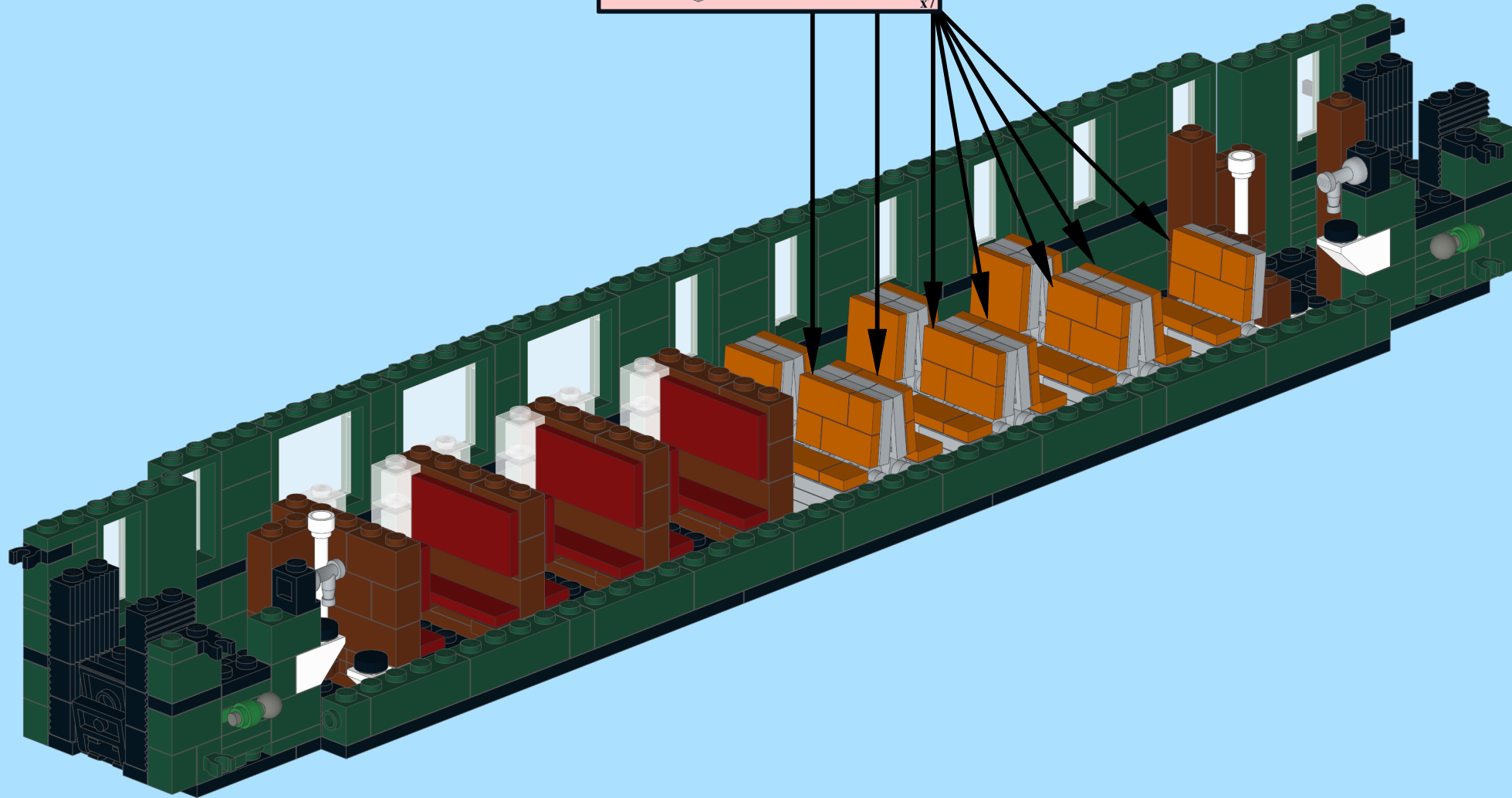
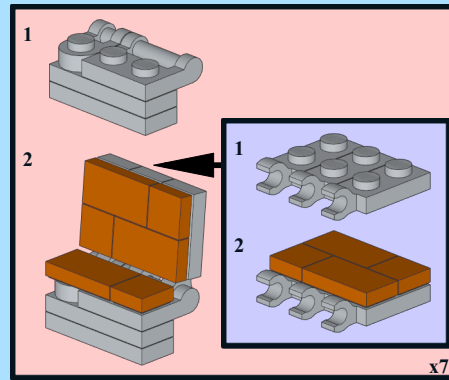
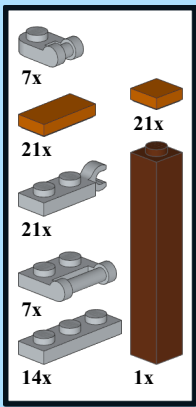

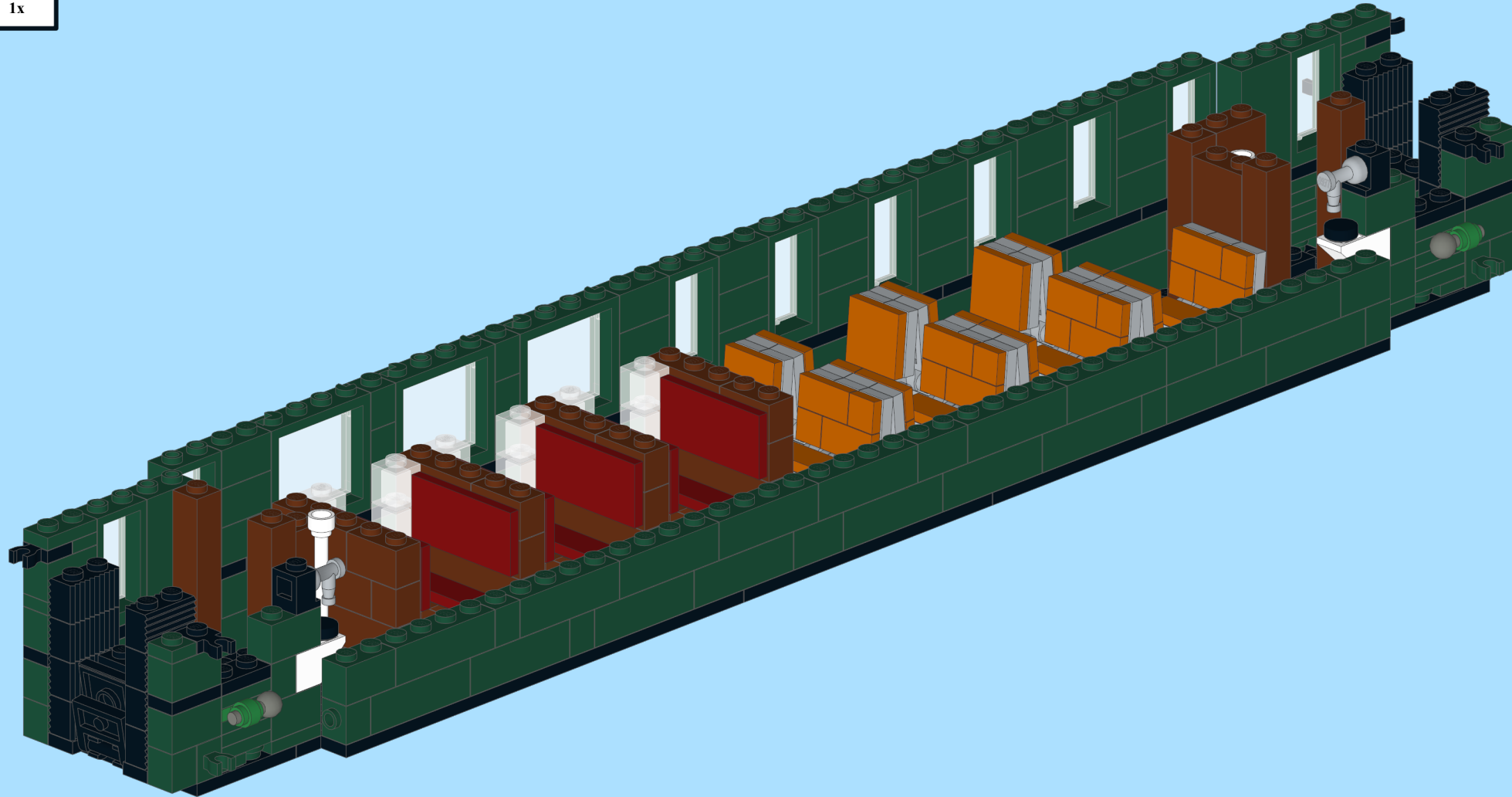
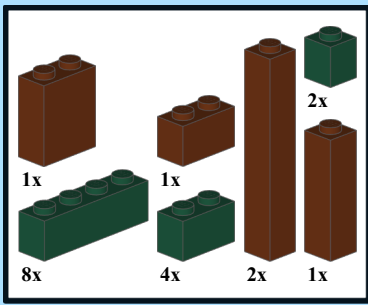

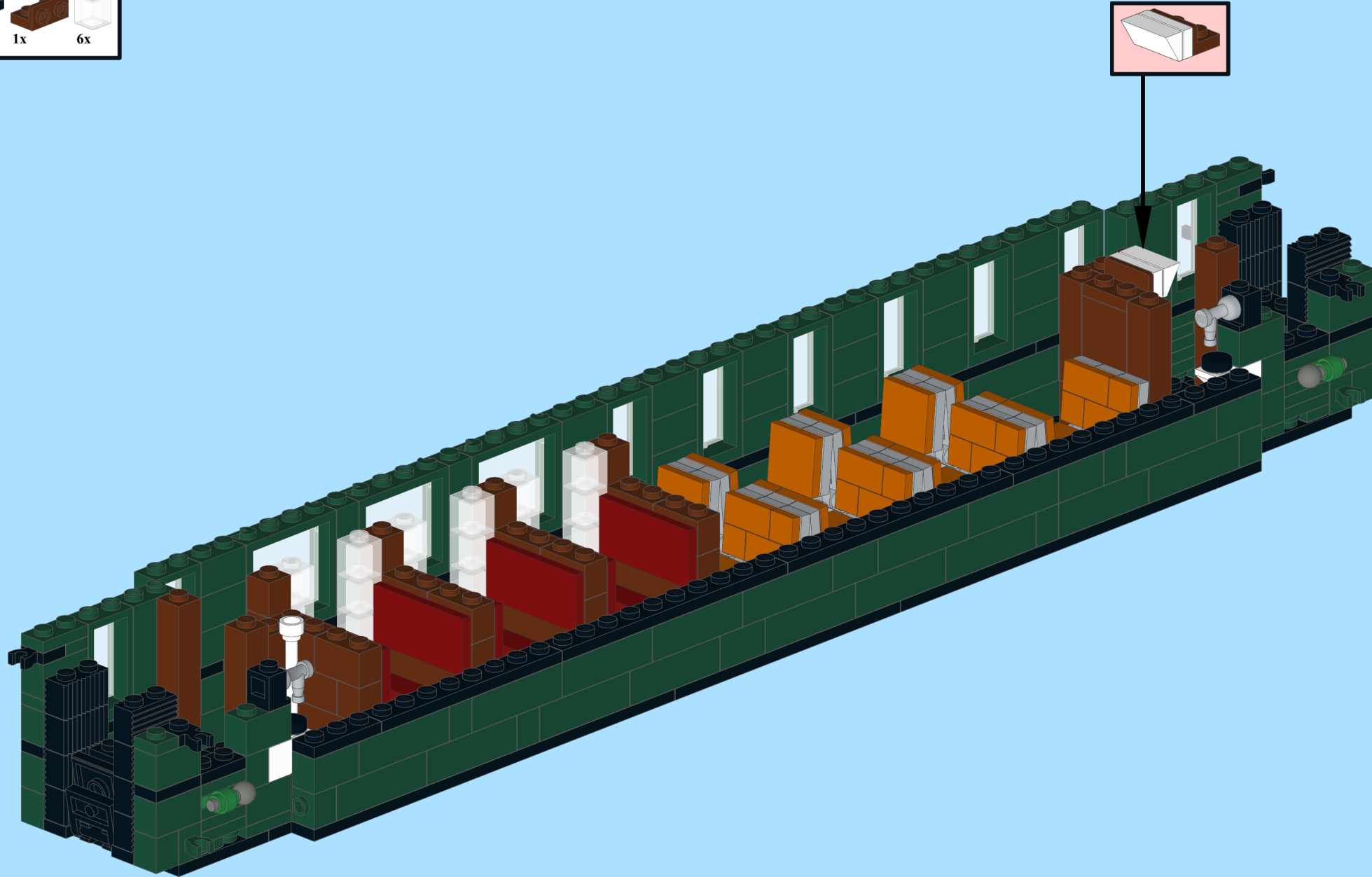
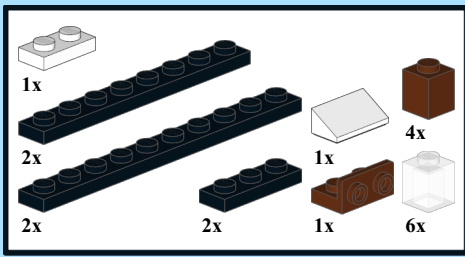

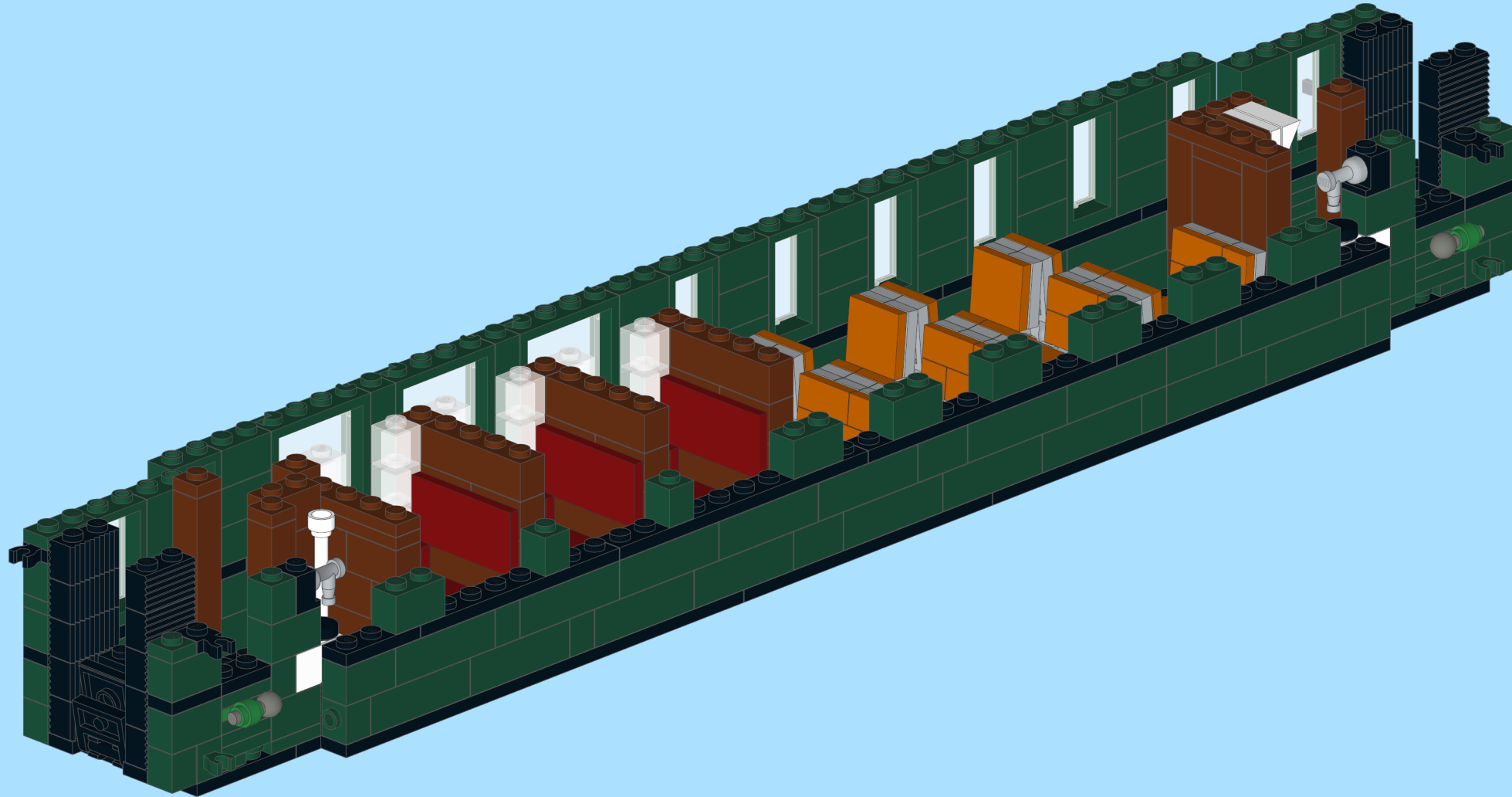
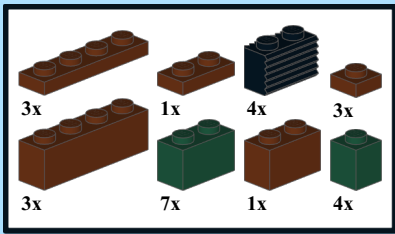

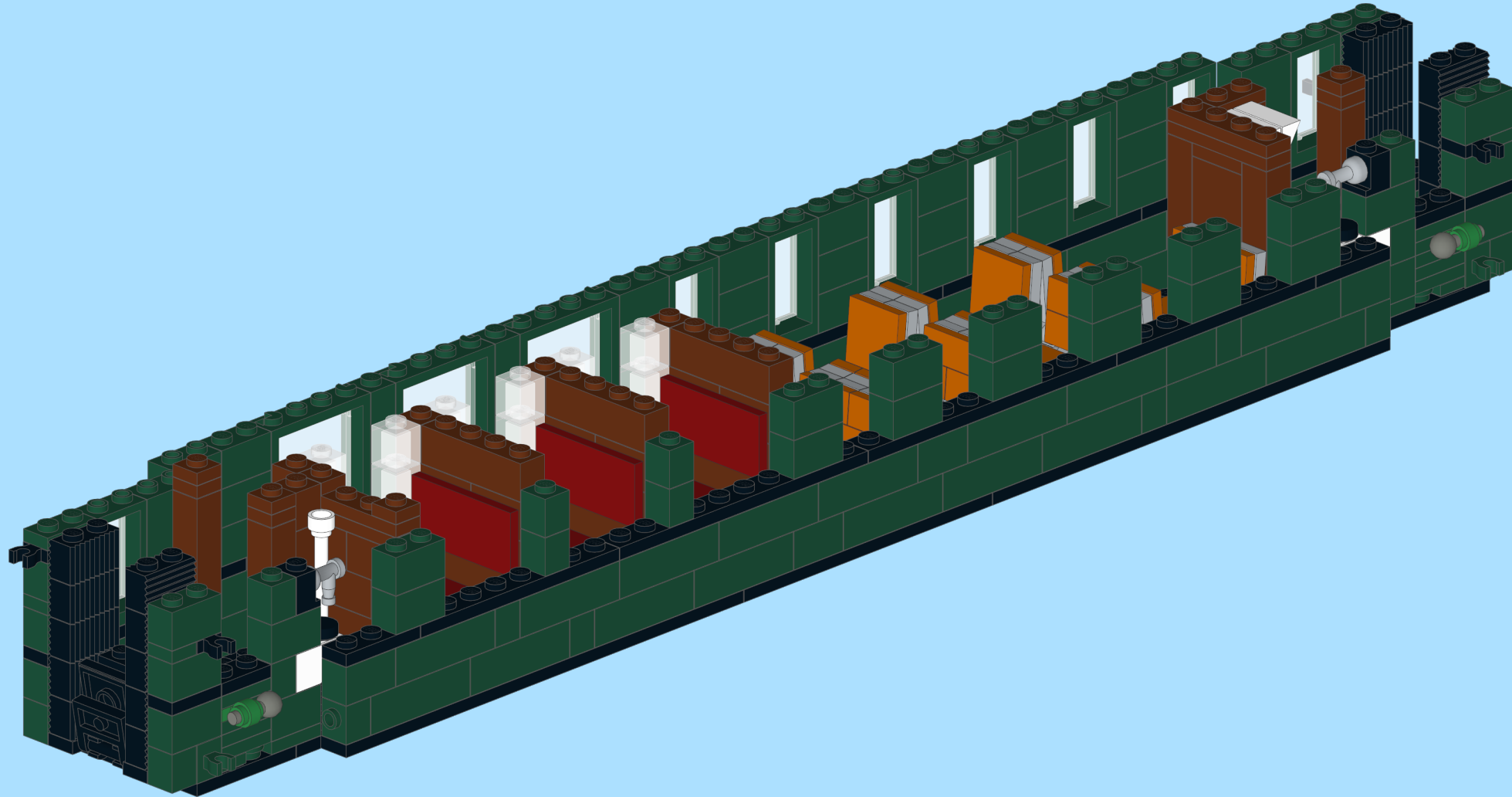
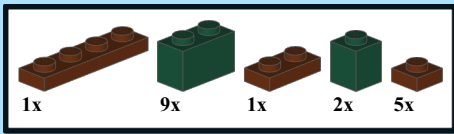

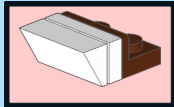
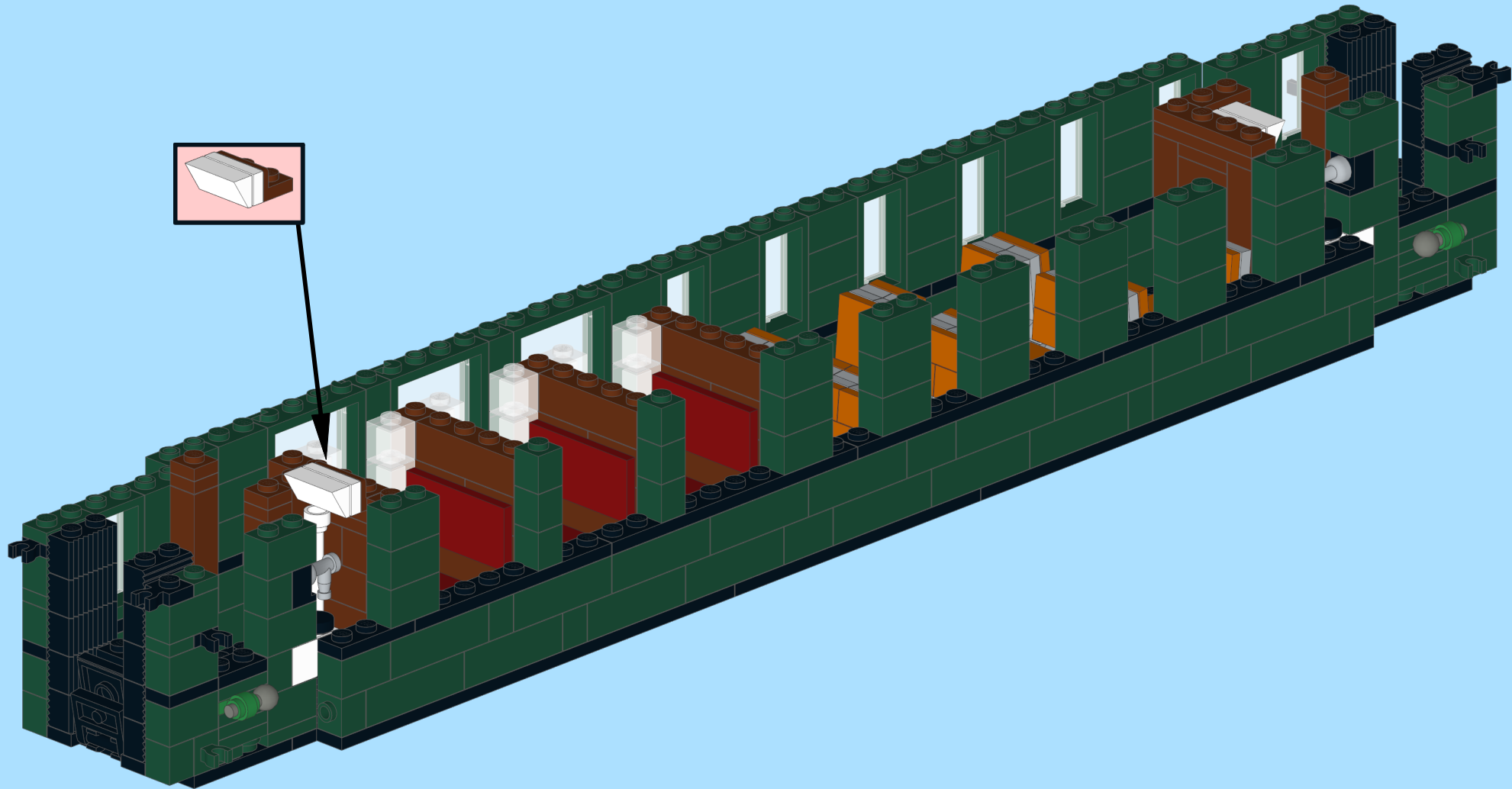
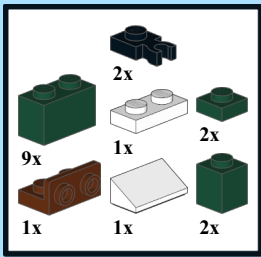

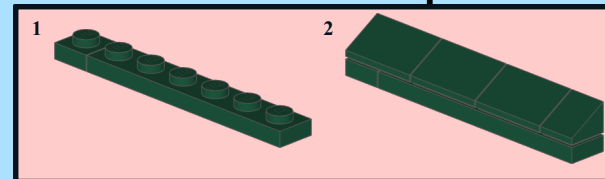
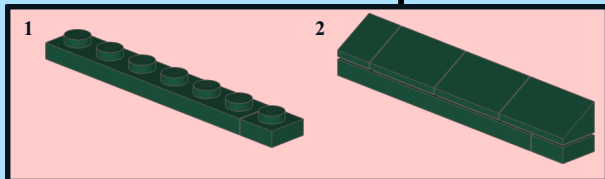
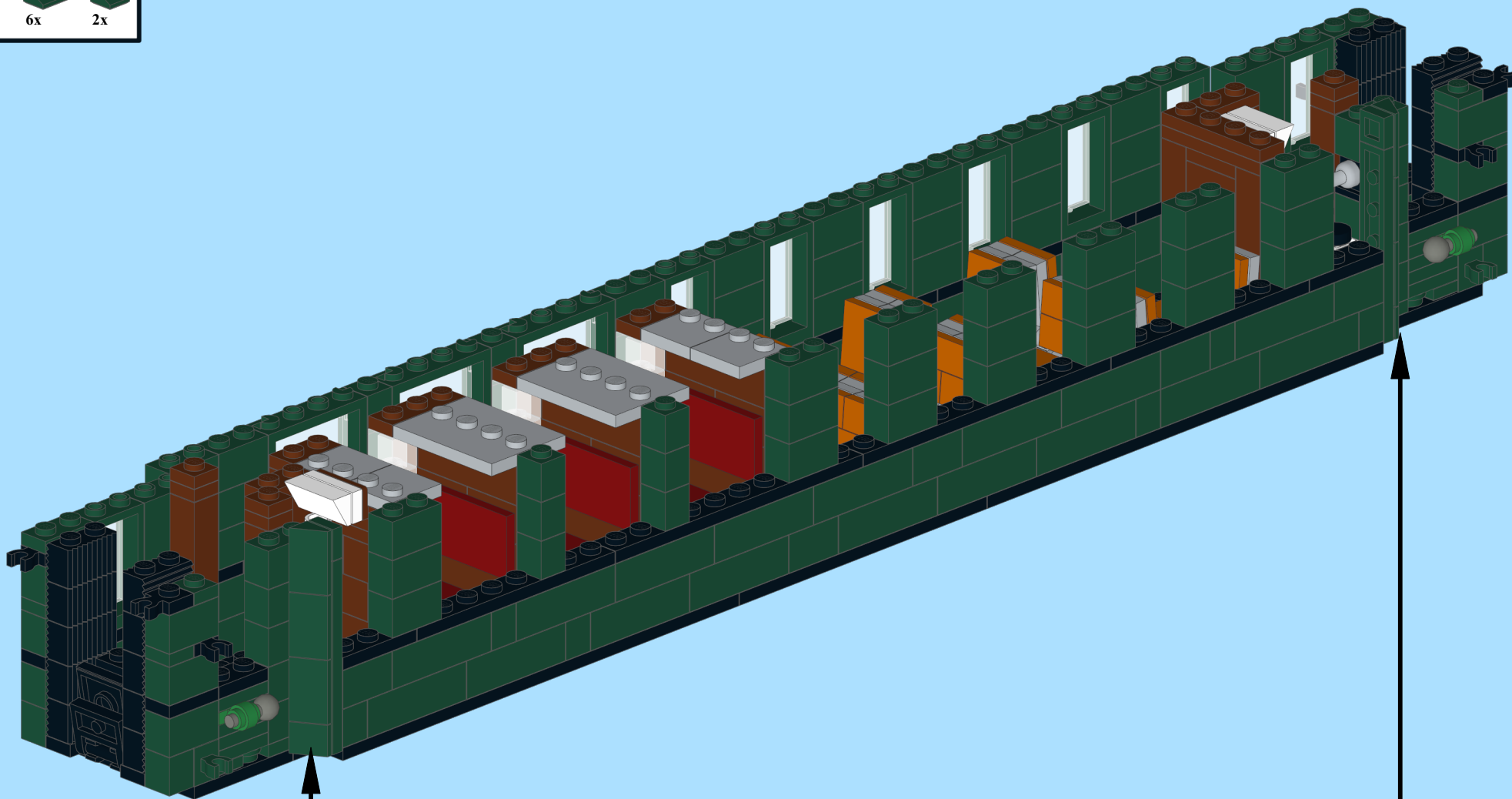
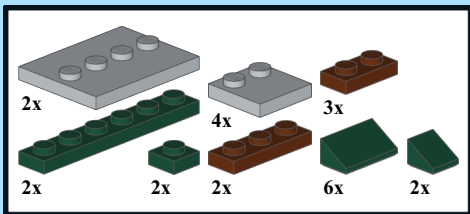

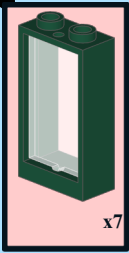
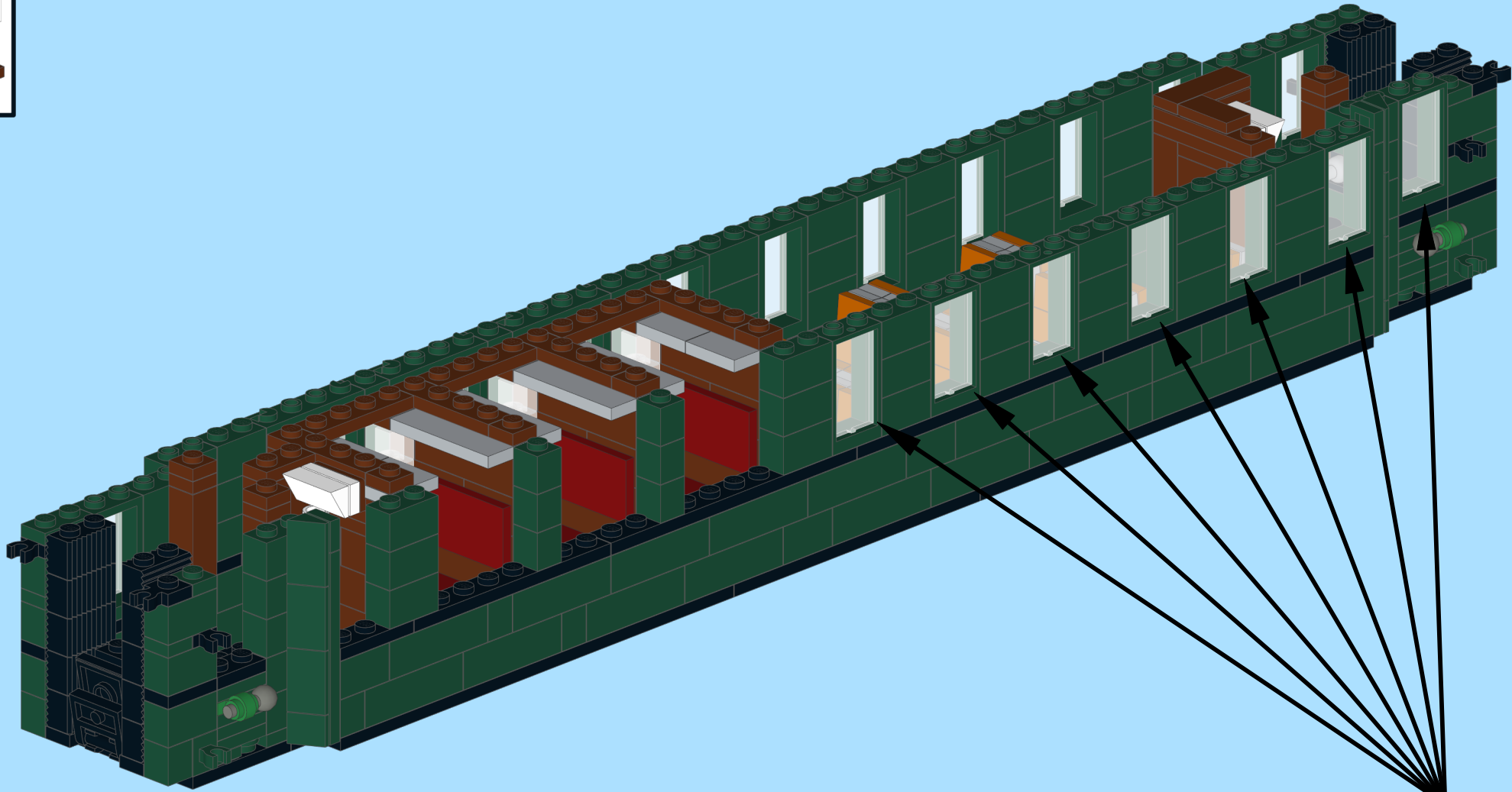
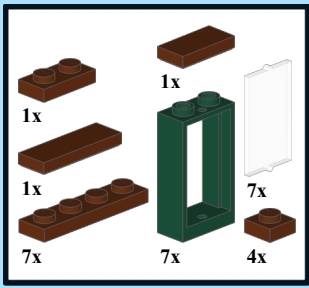

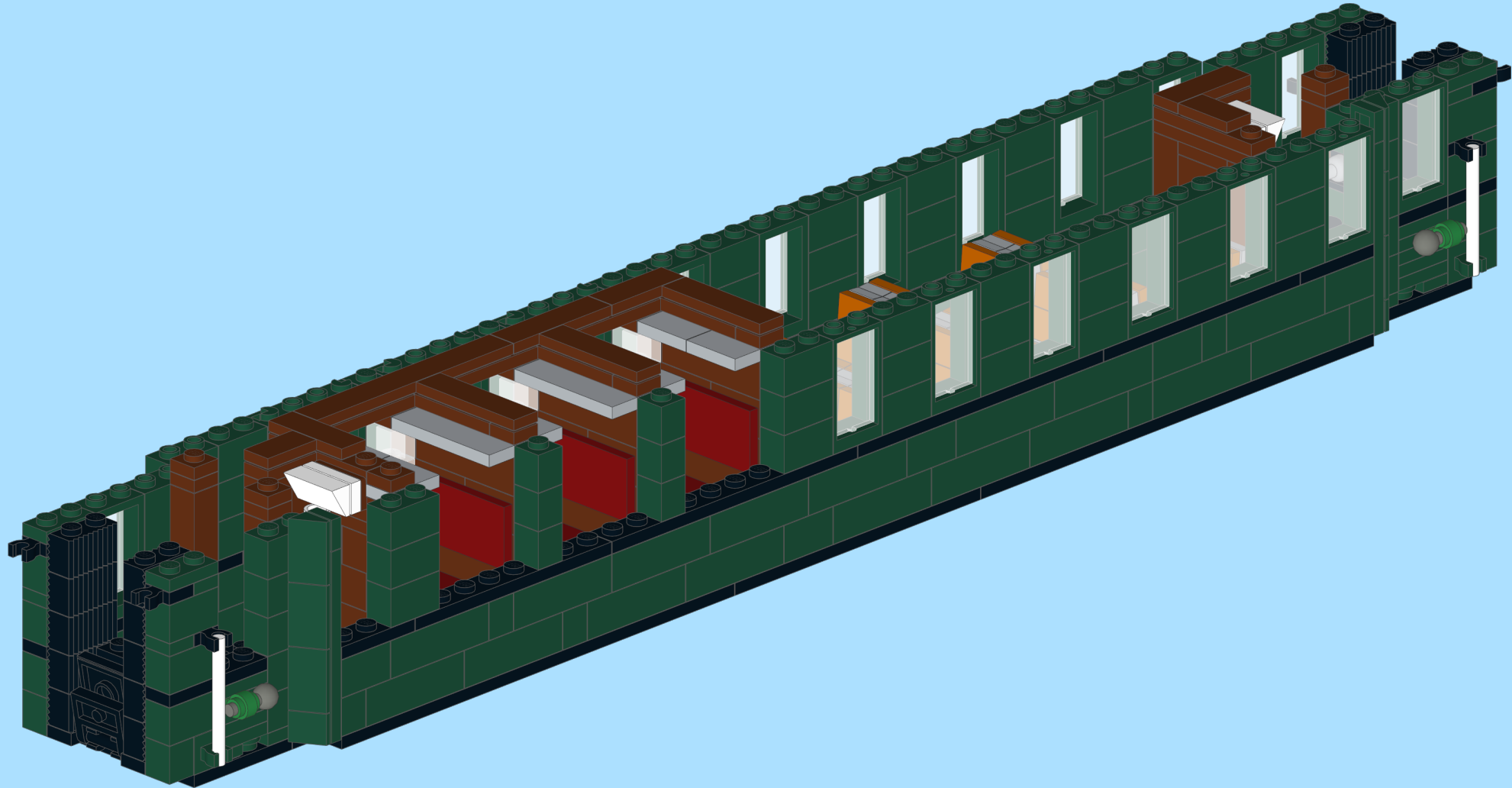
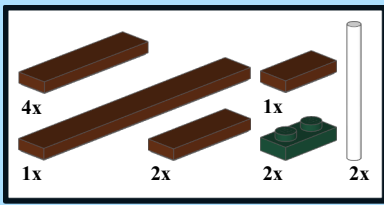

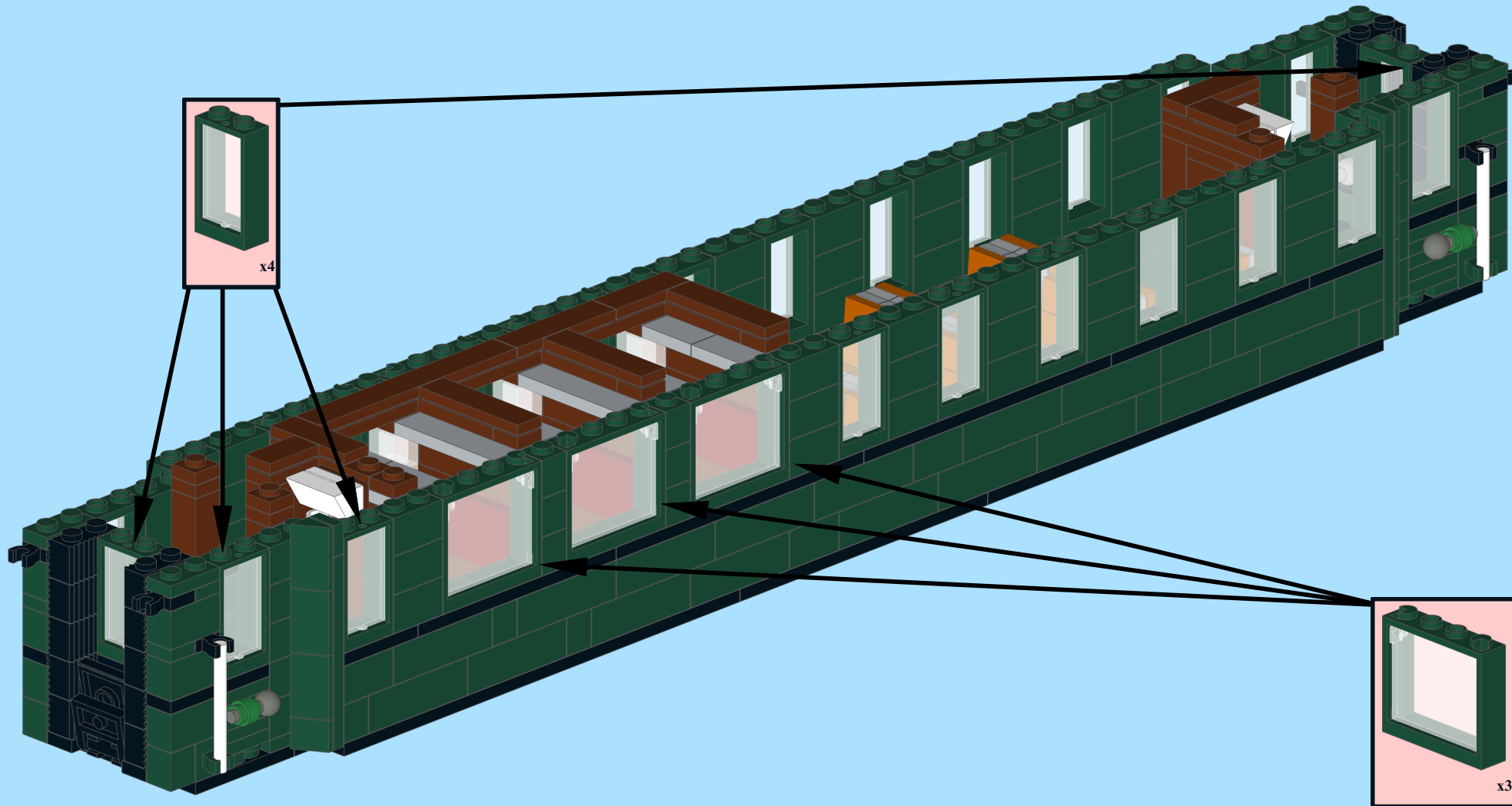
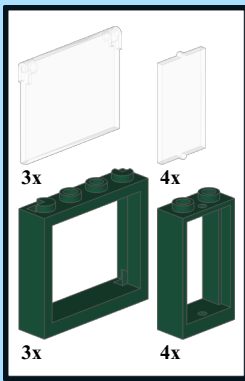

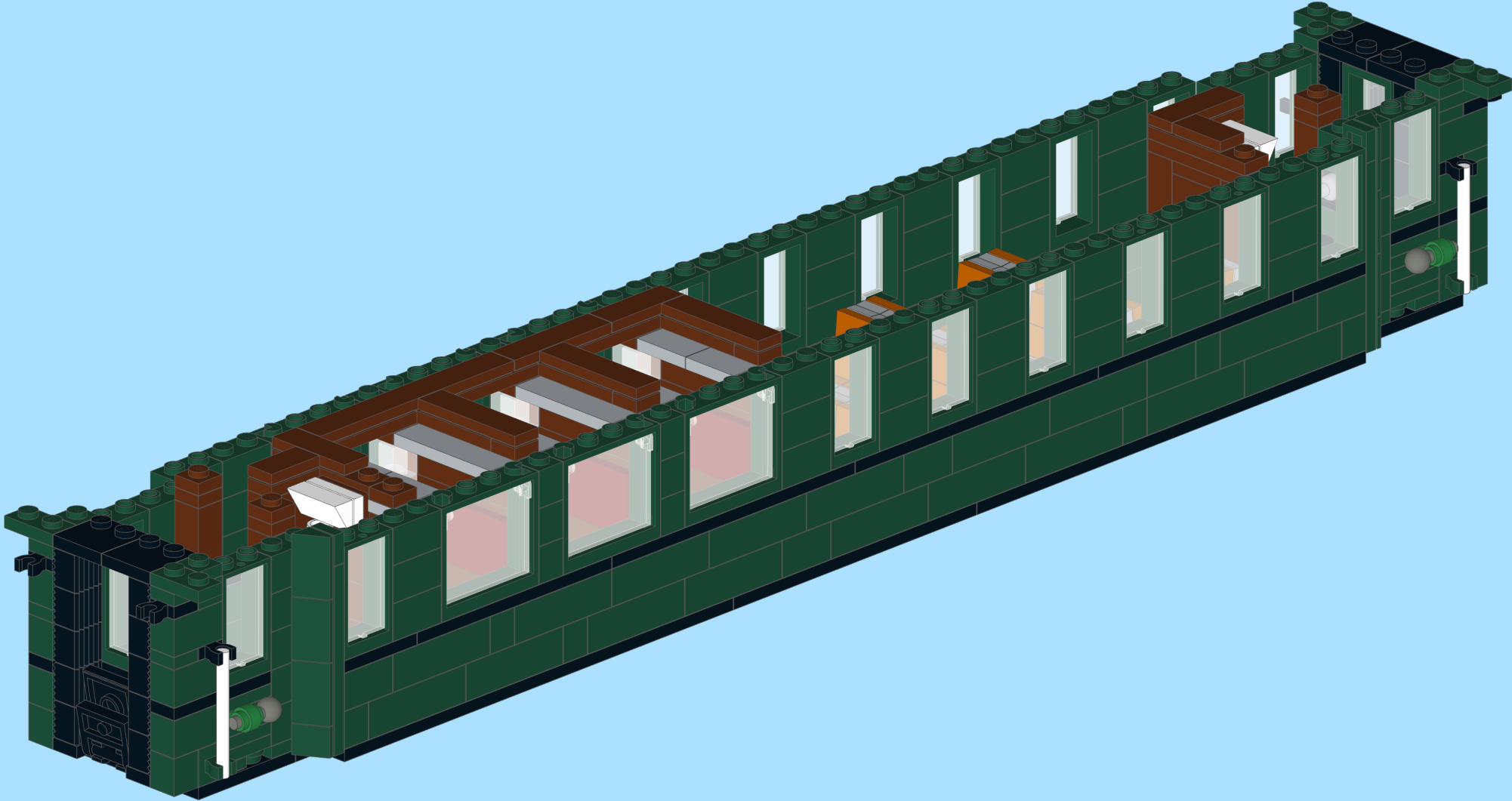
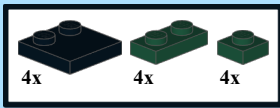

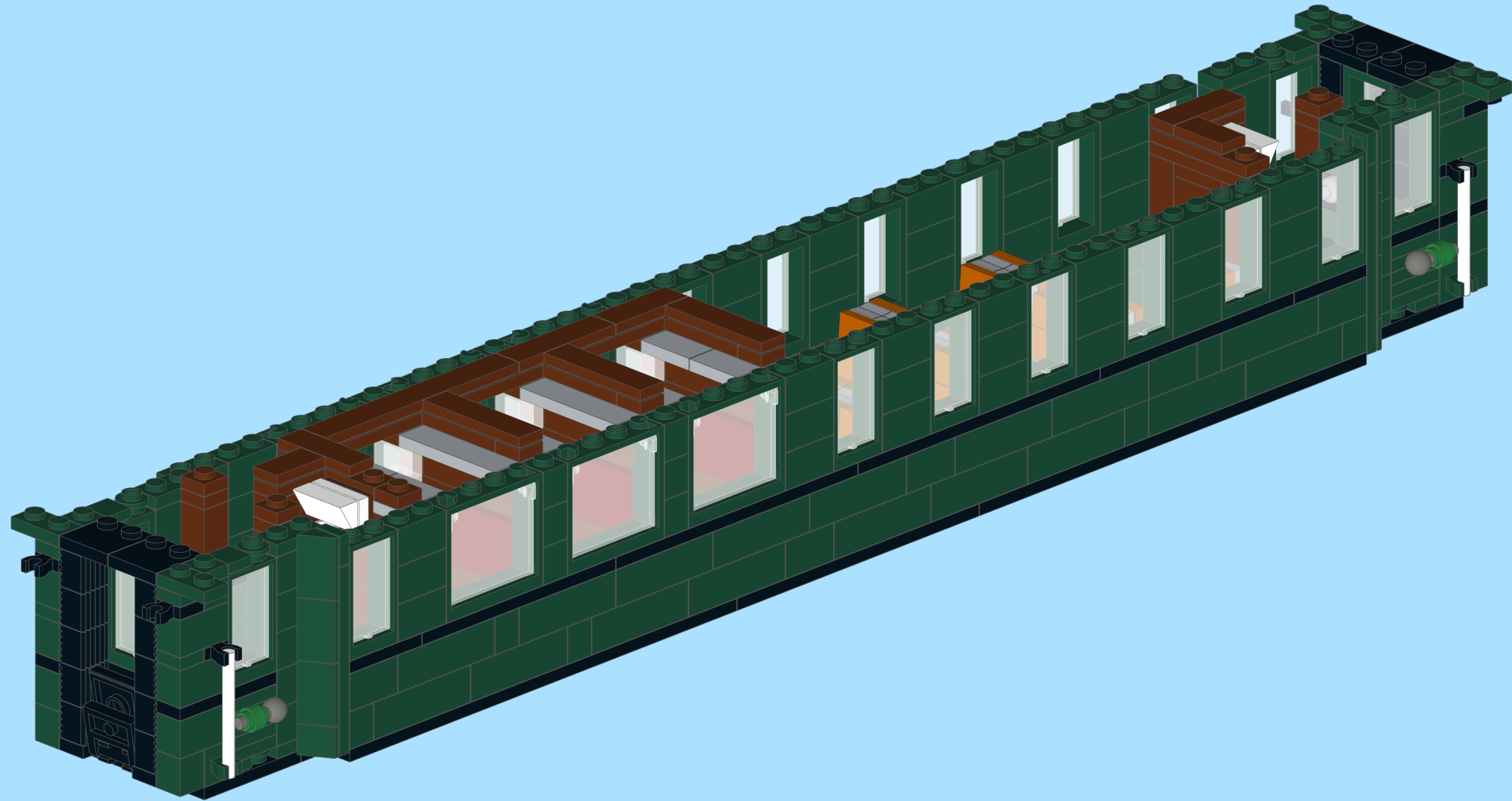
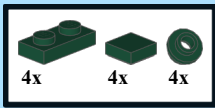

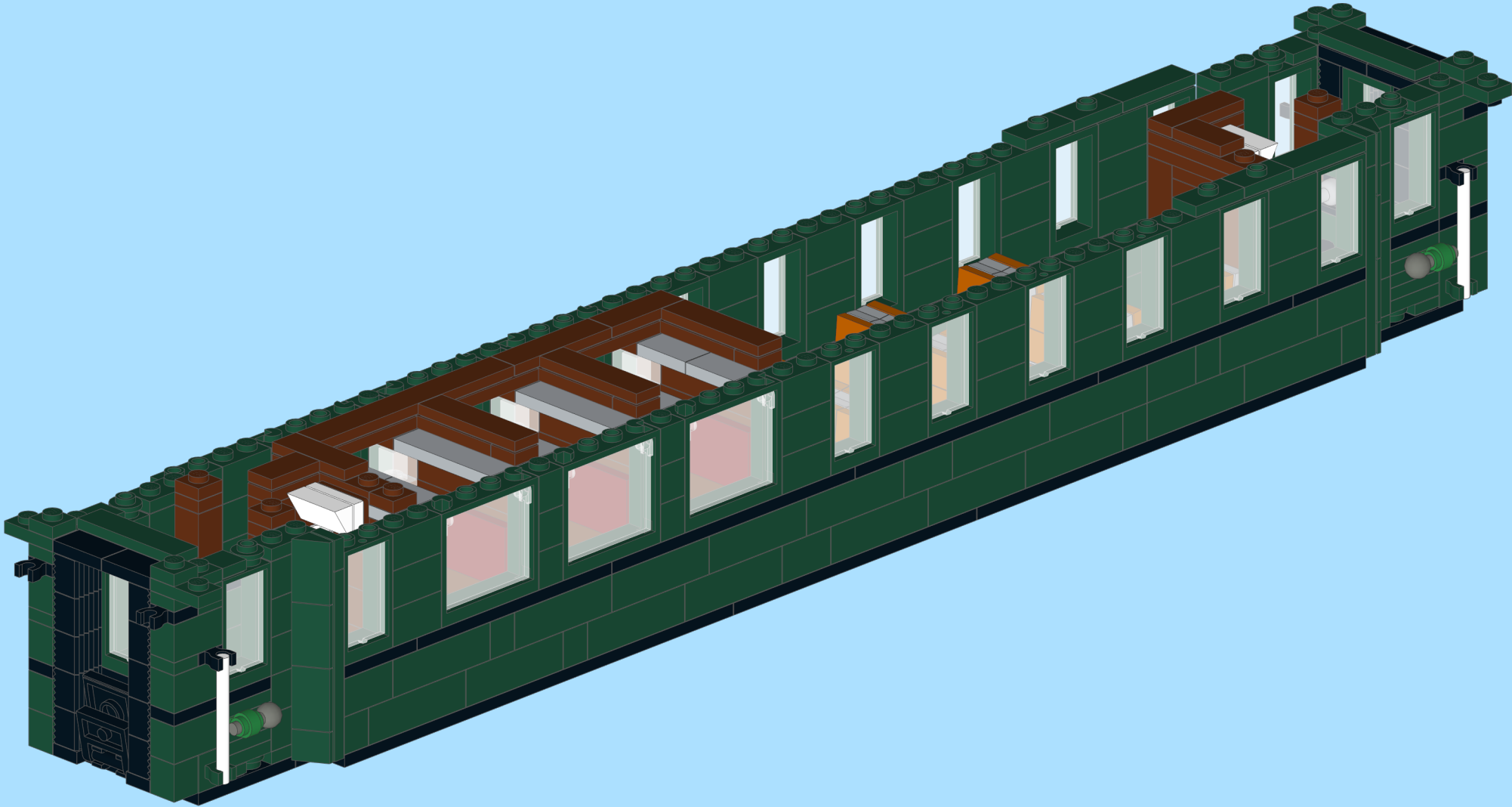
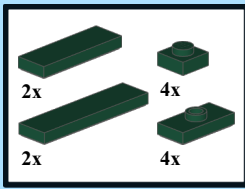

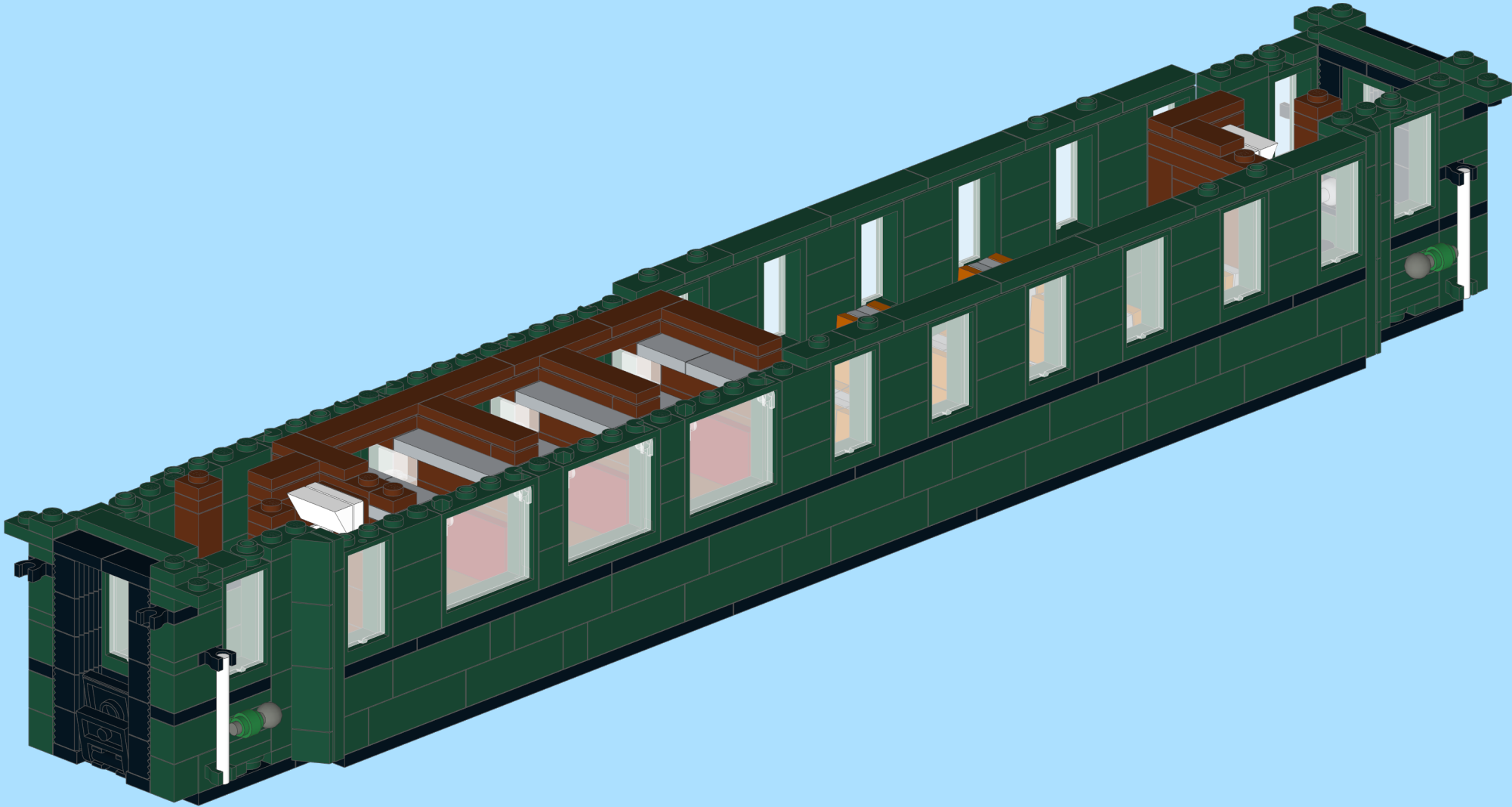
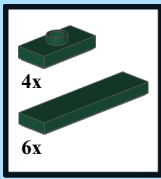

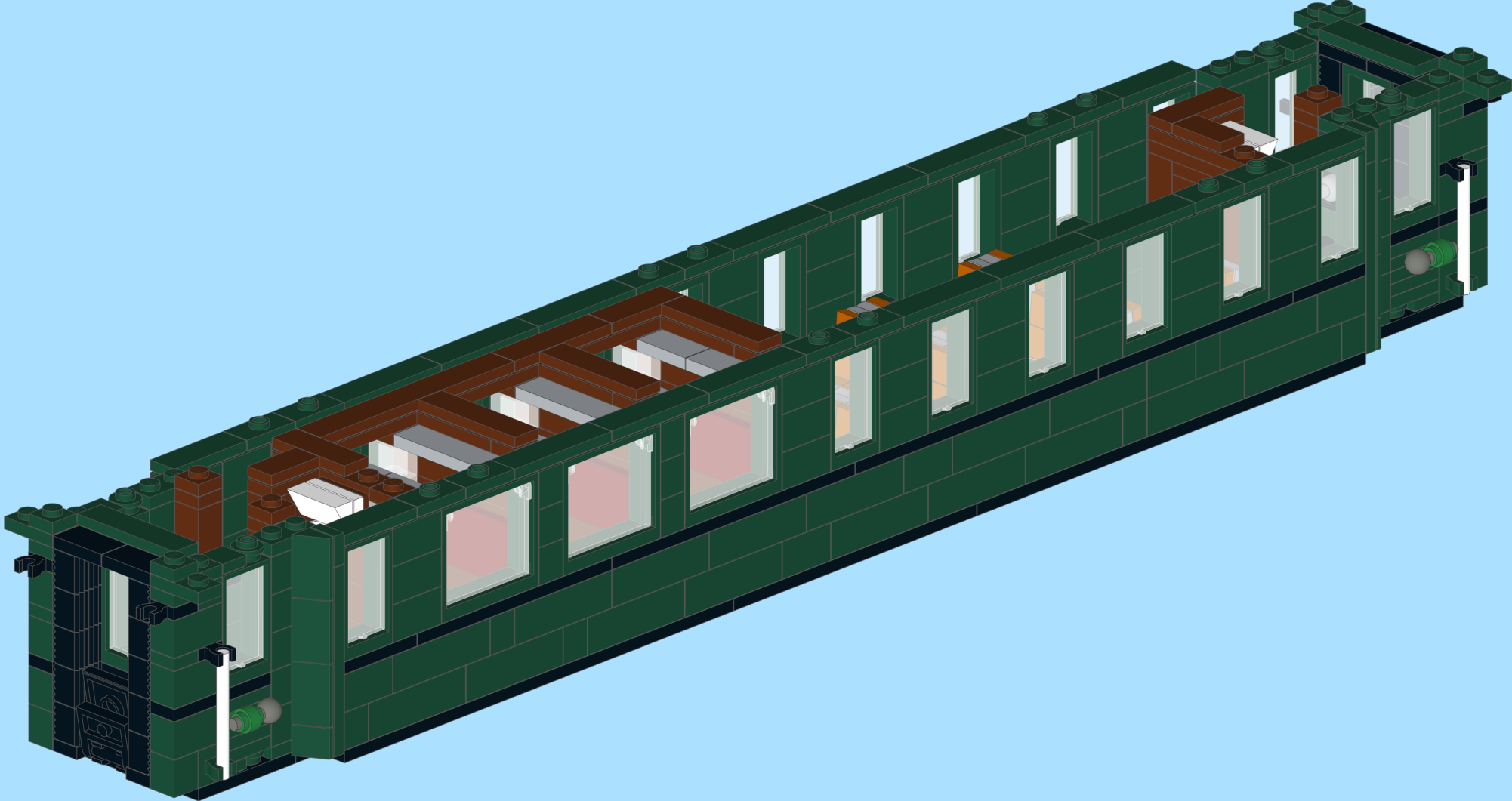
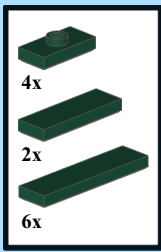

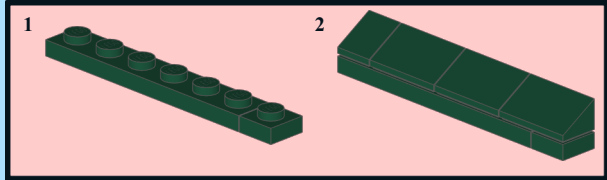
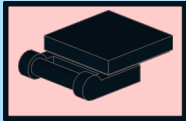
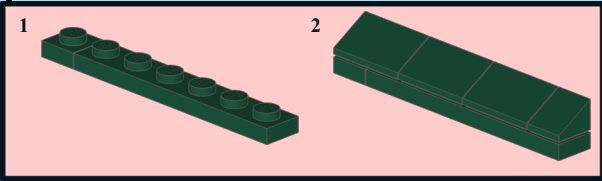
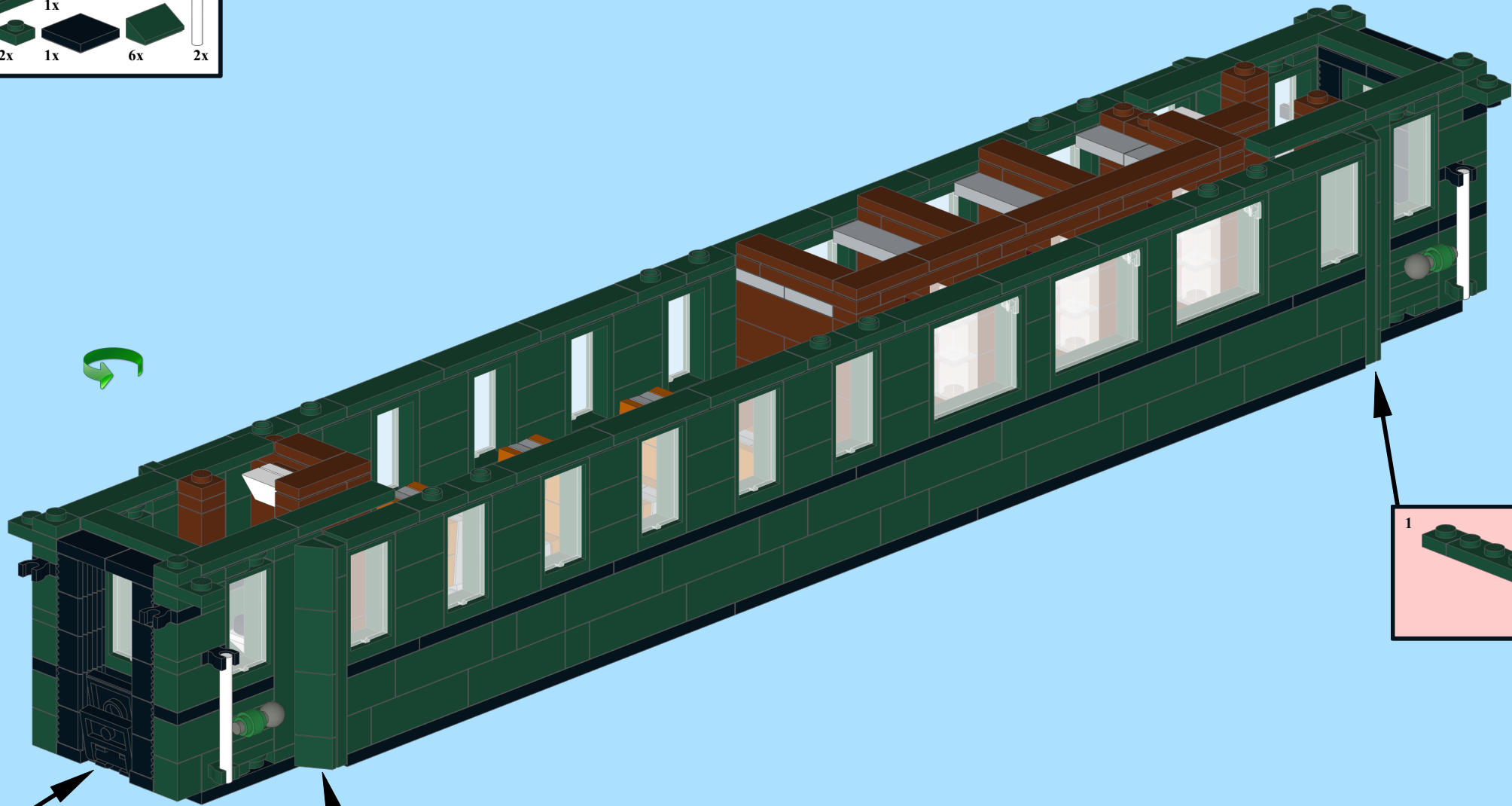
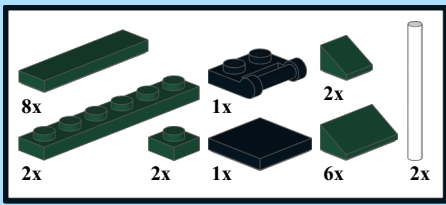

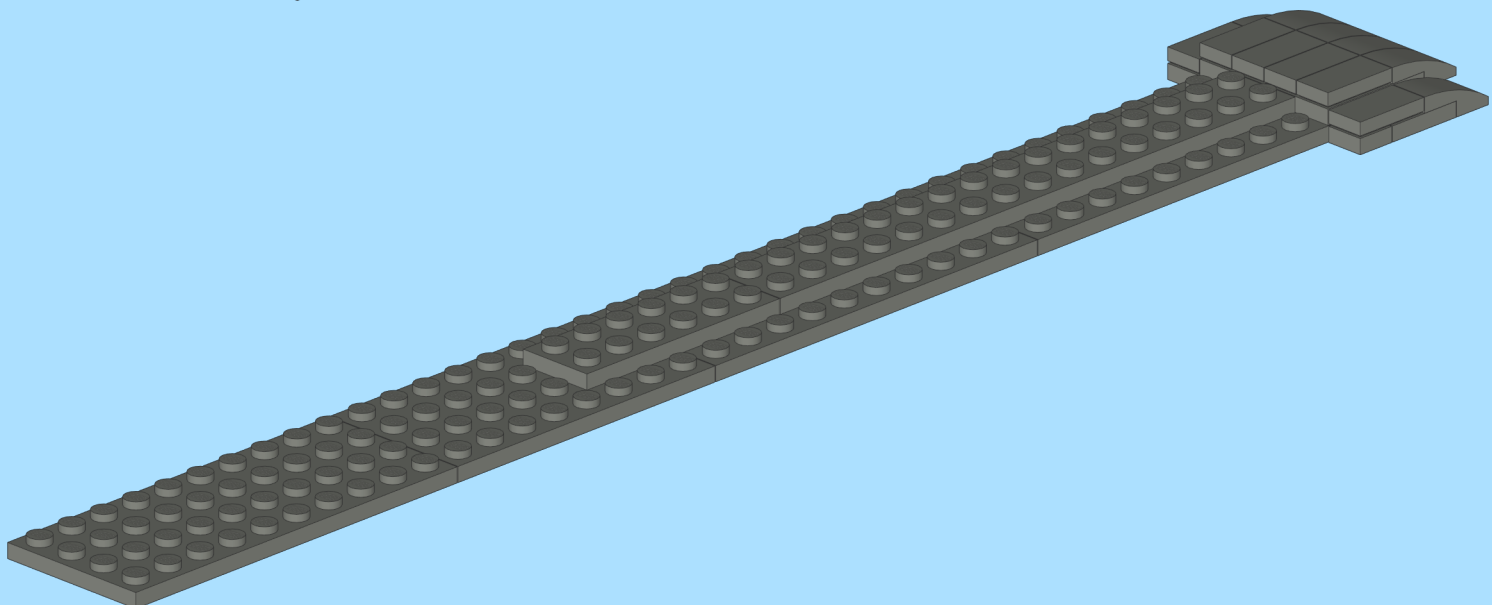
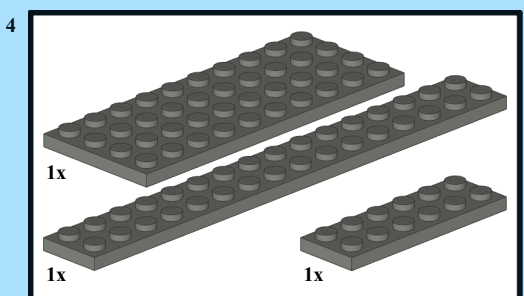
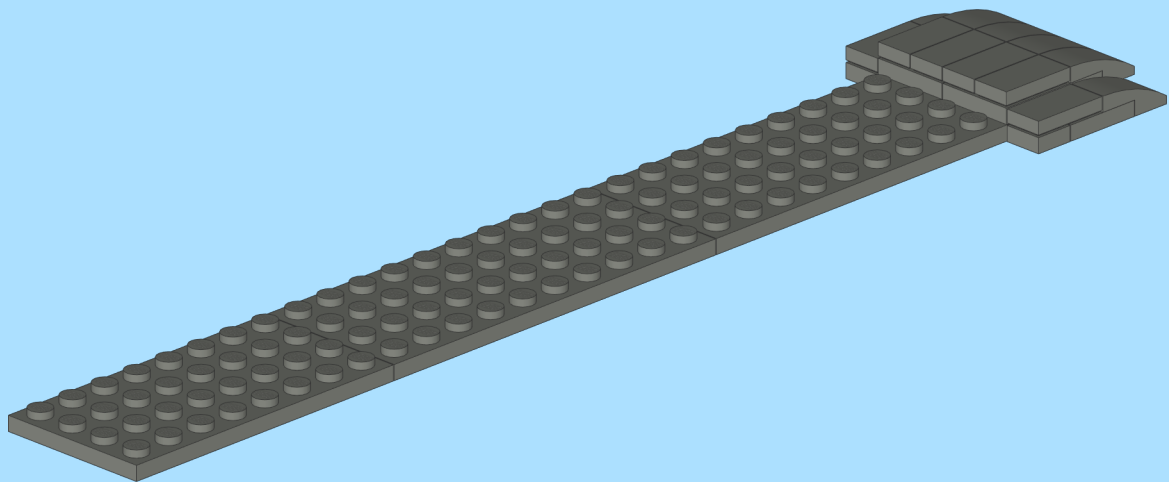
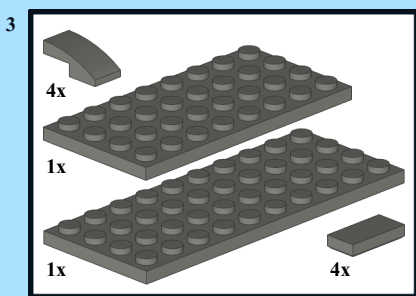
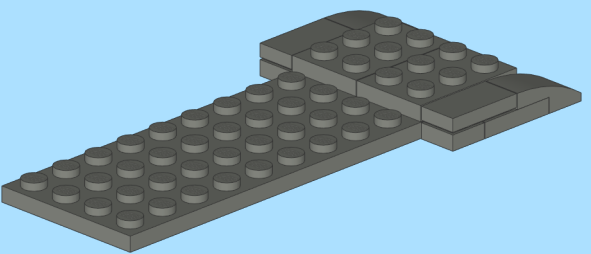
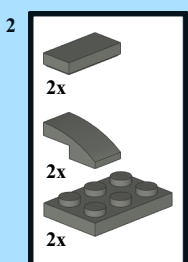
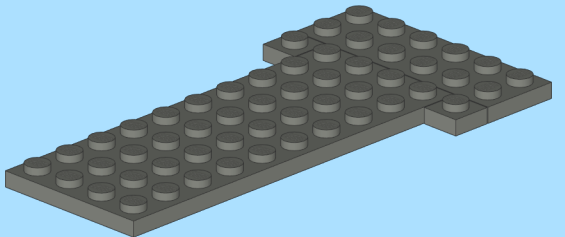
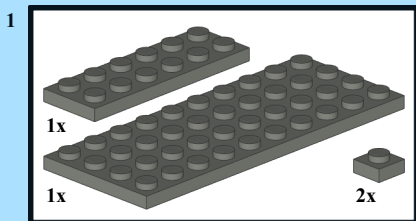

5

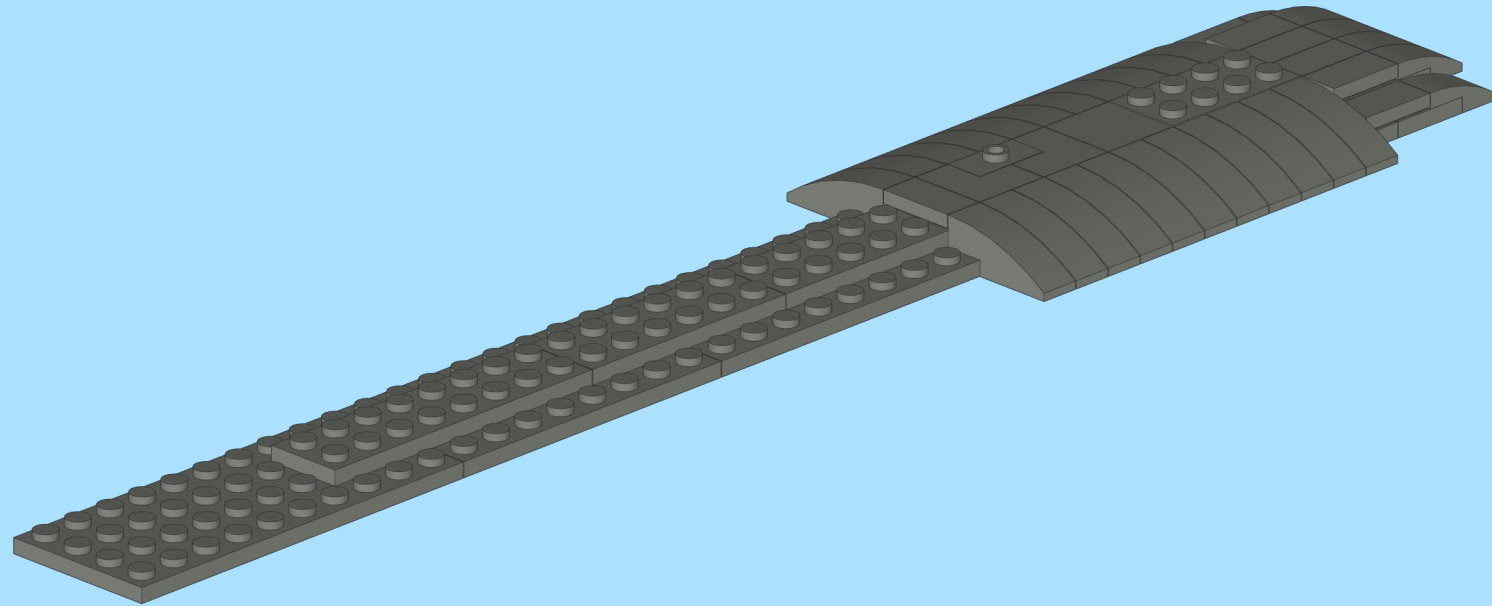
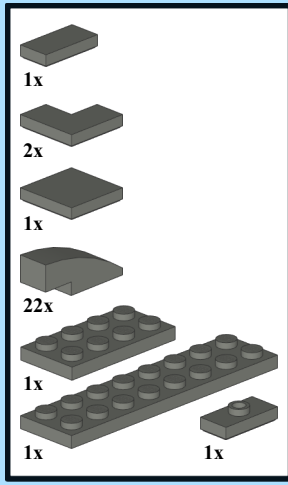

6

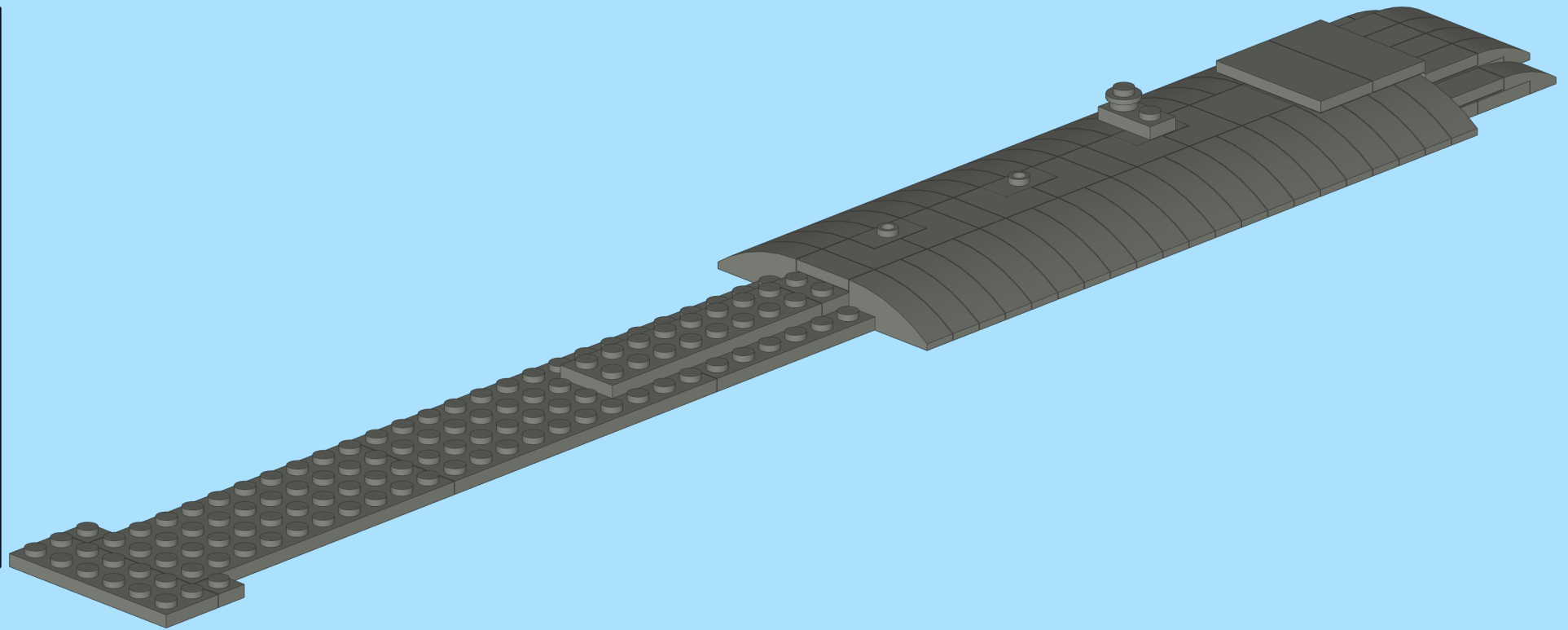
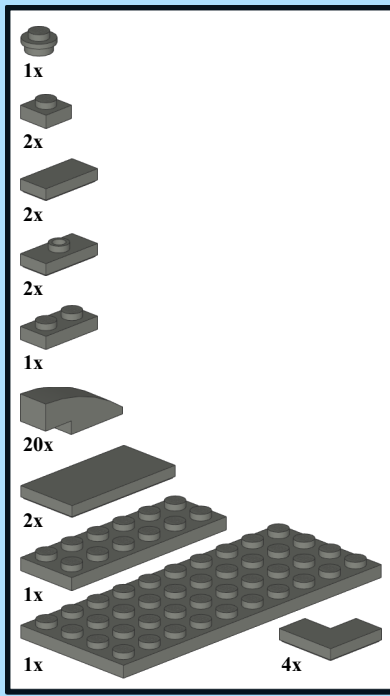

7

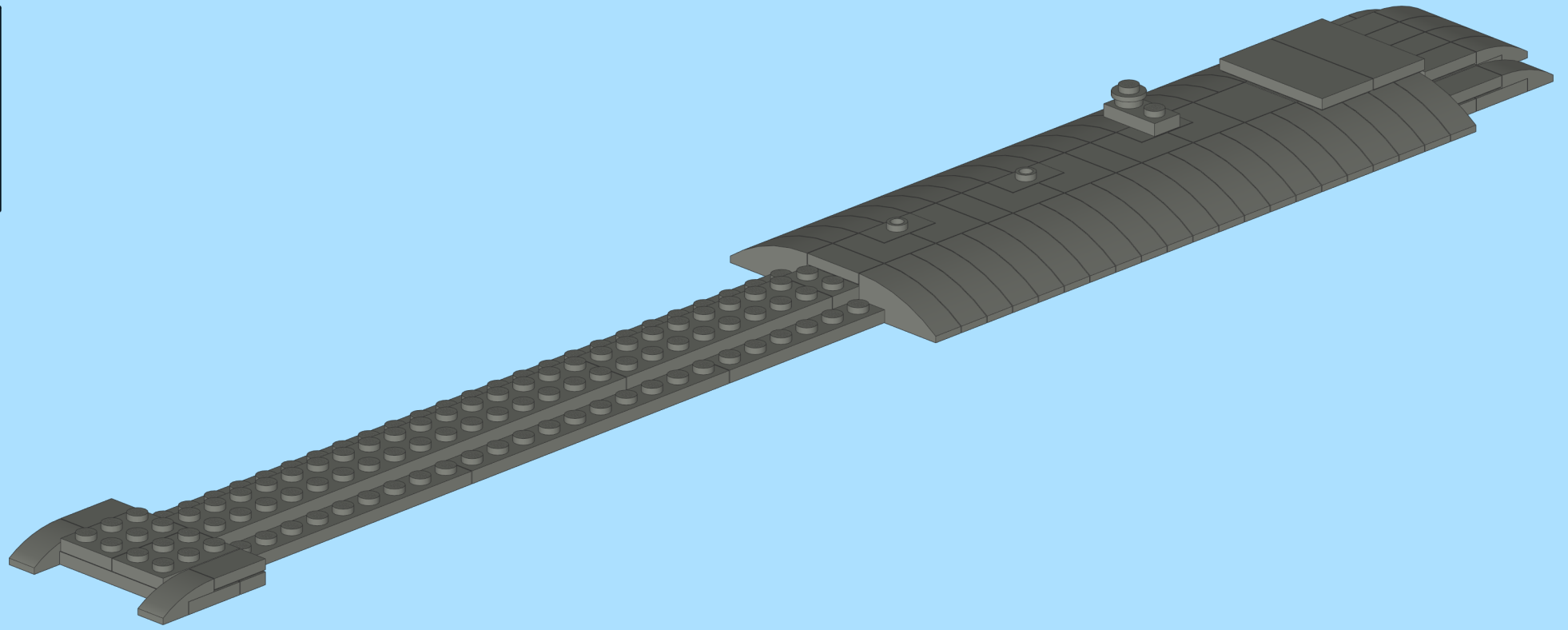
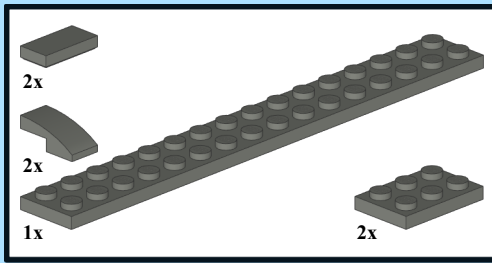

8

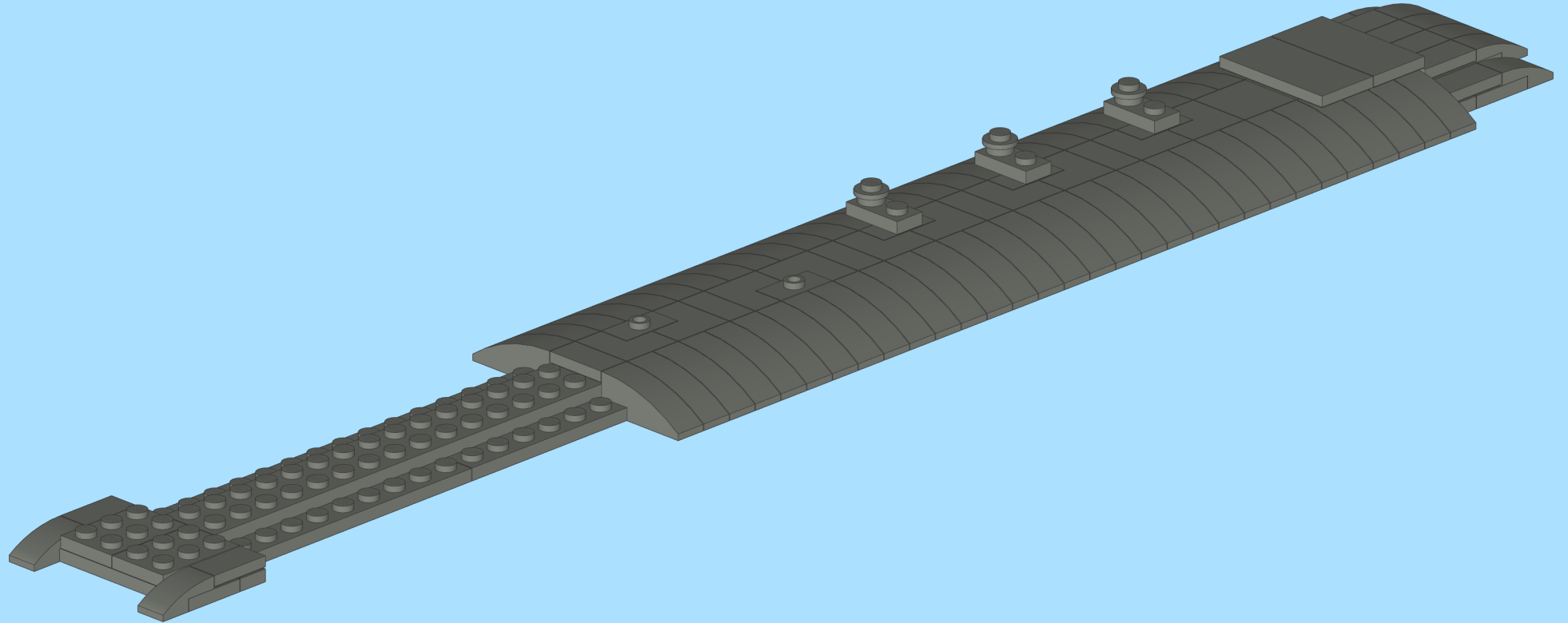
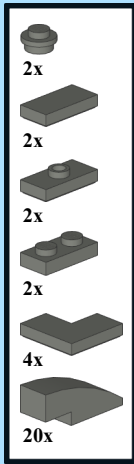

9

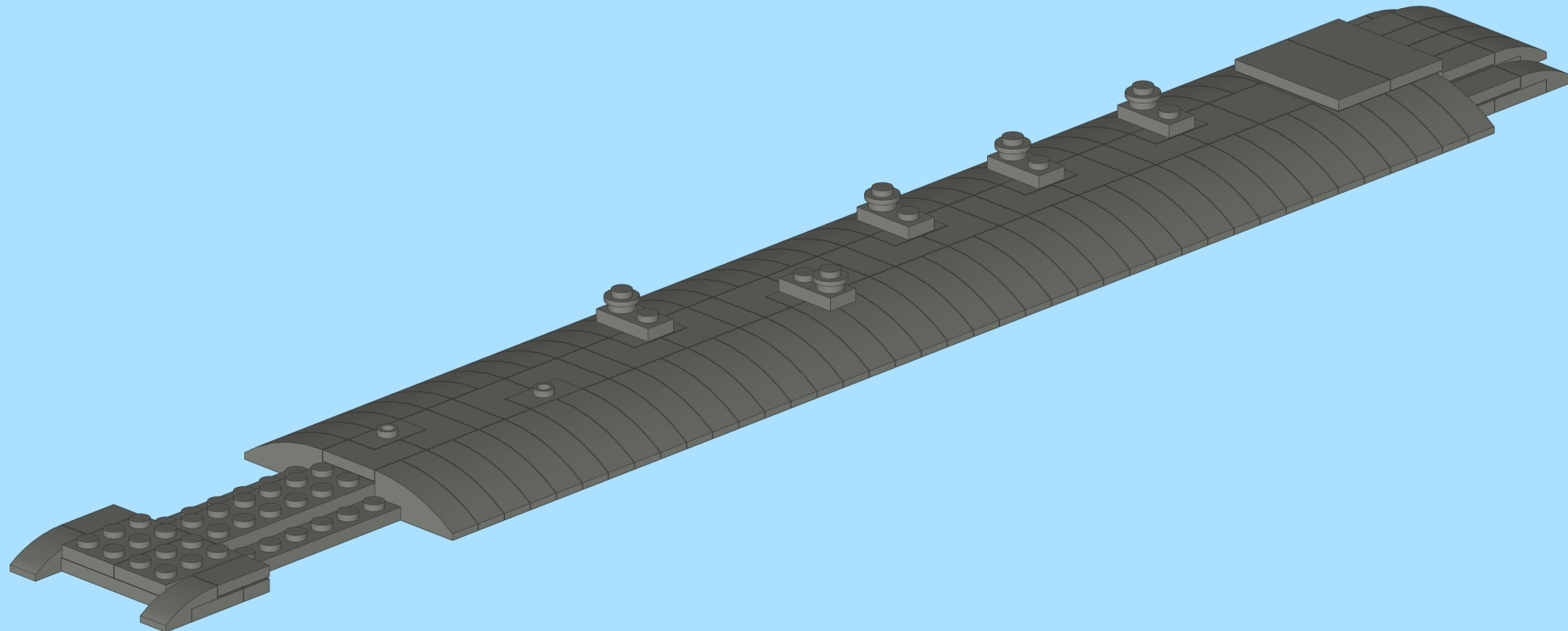
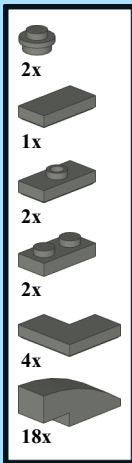

10

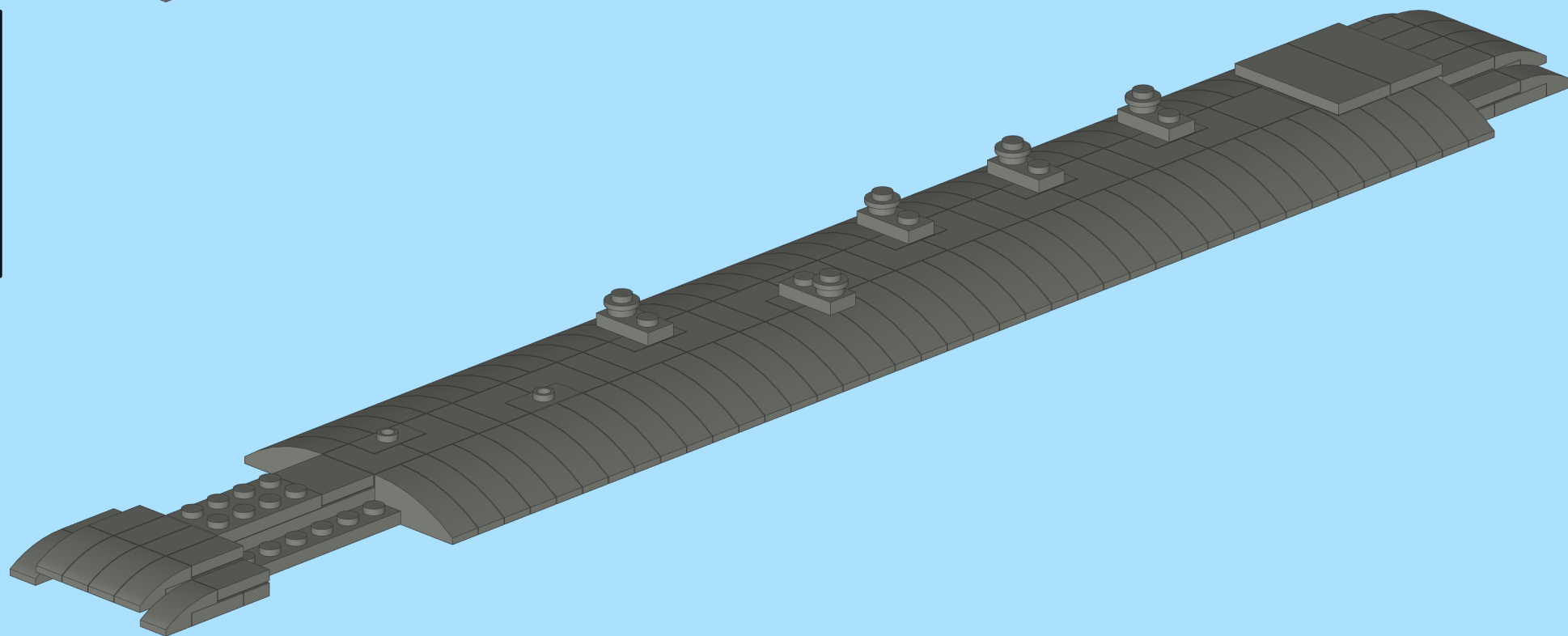
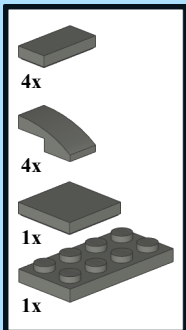

11

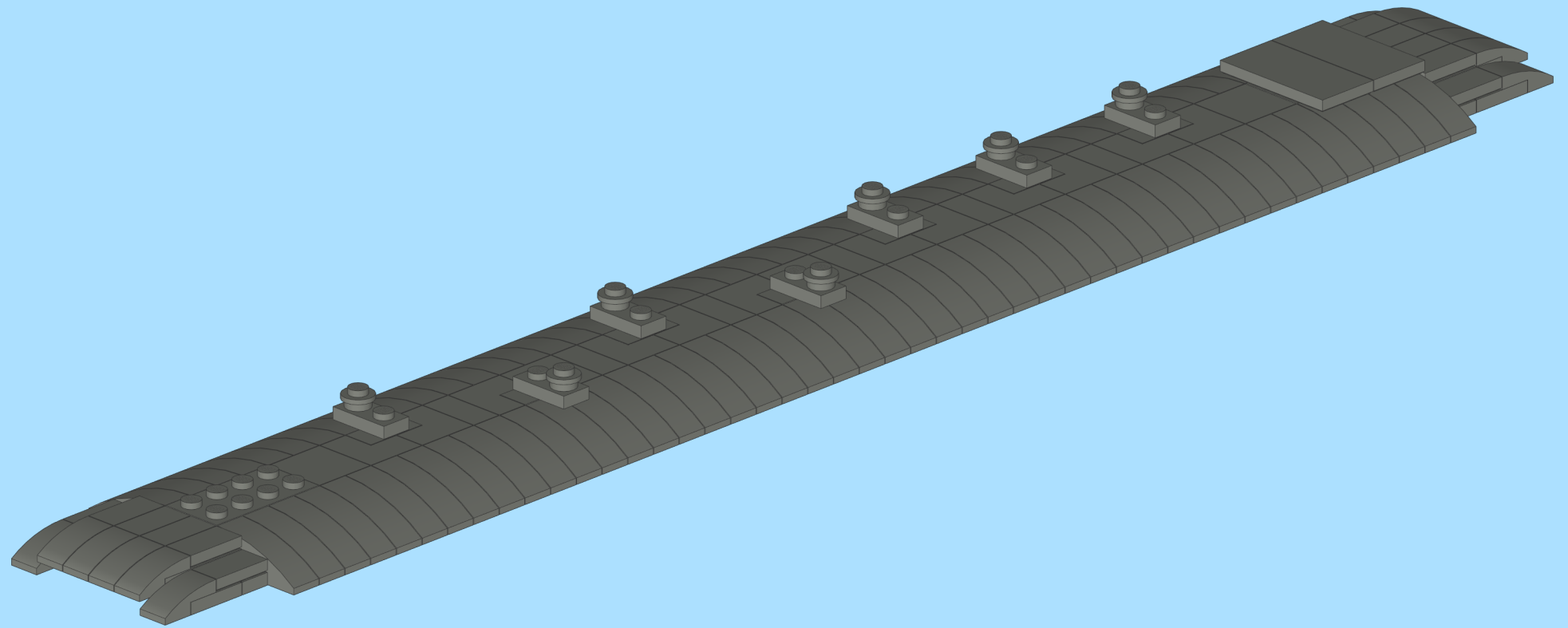
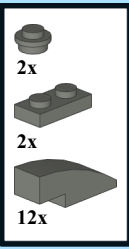

12

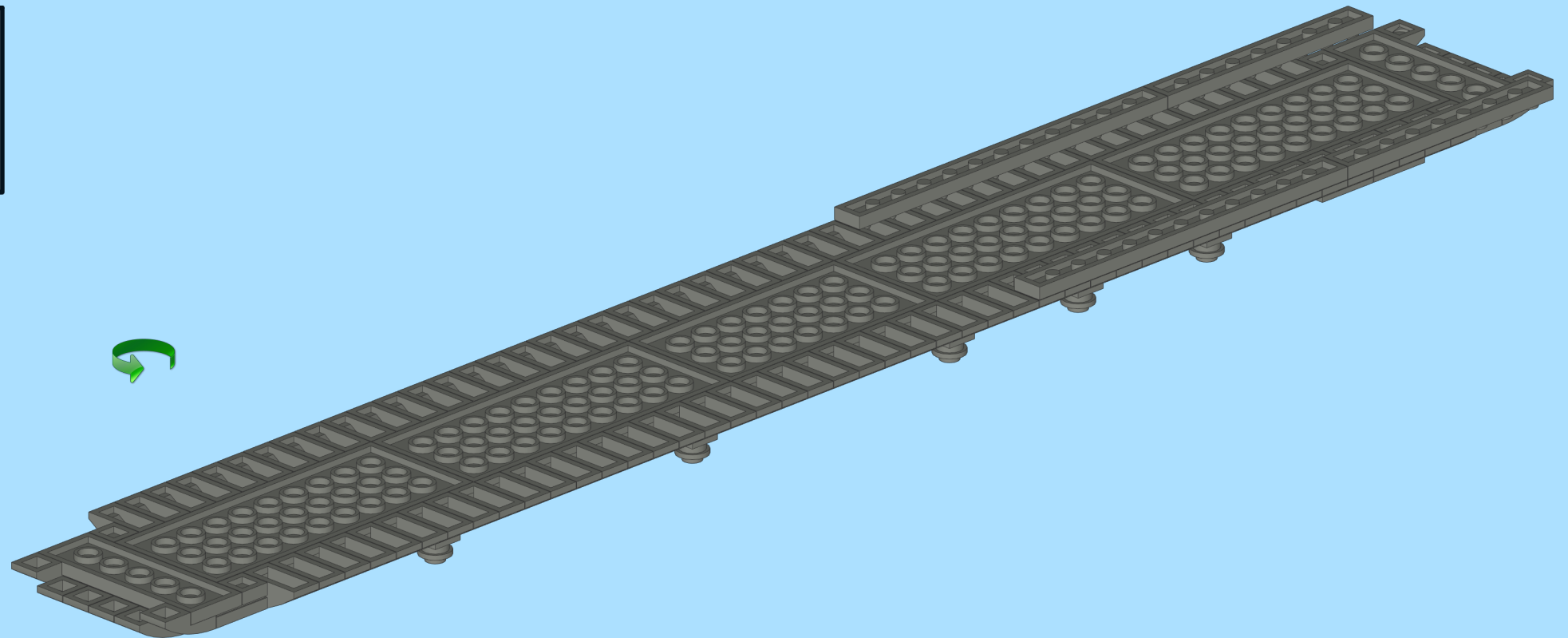
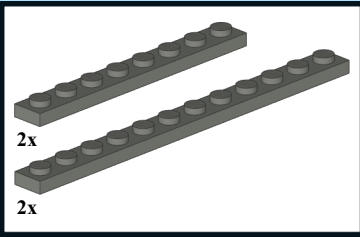

13

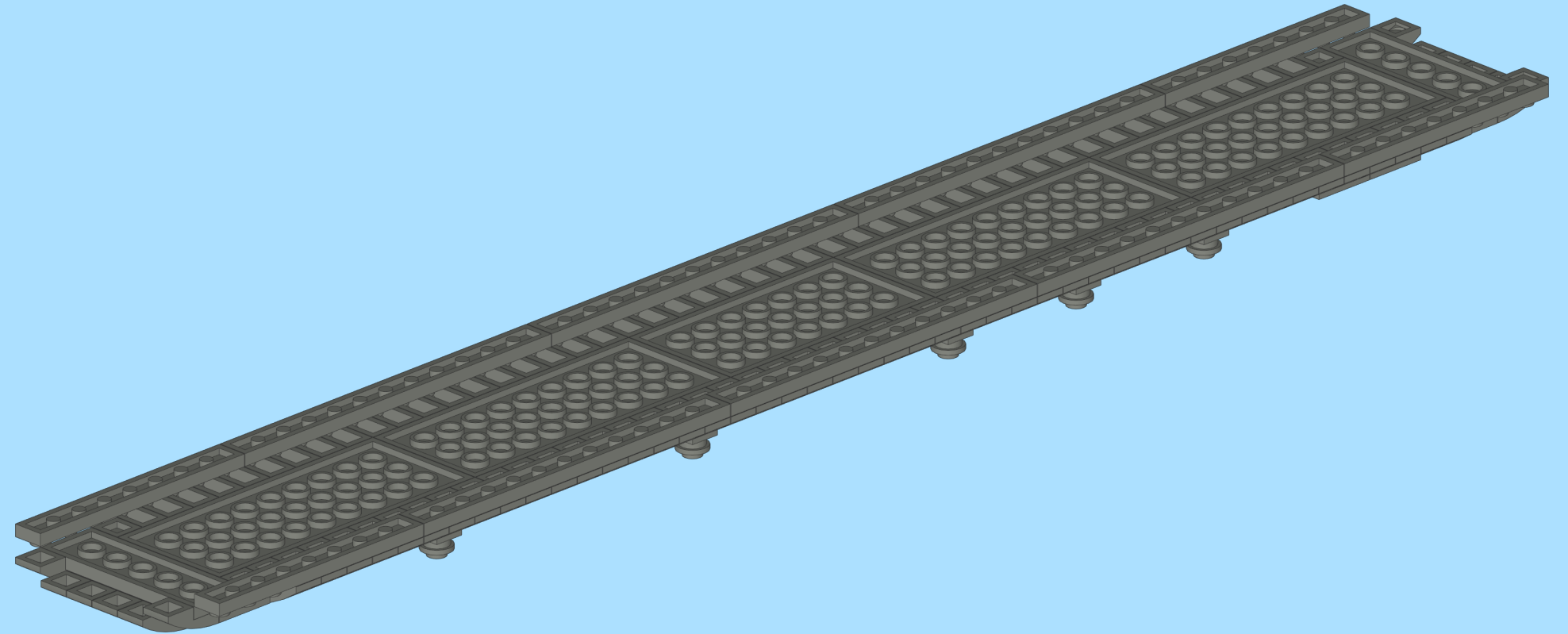
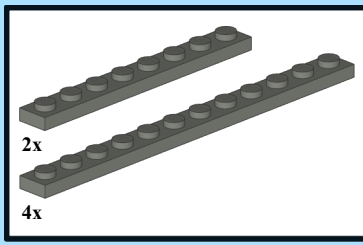

14

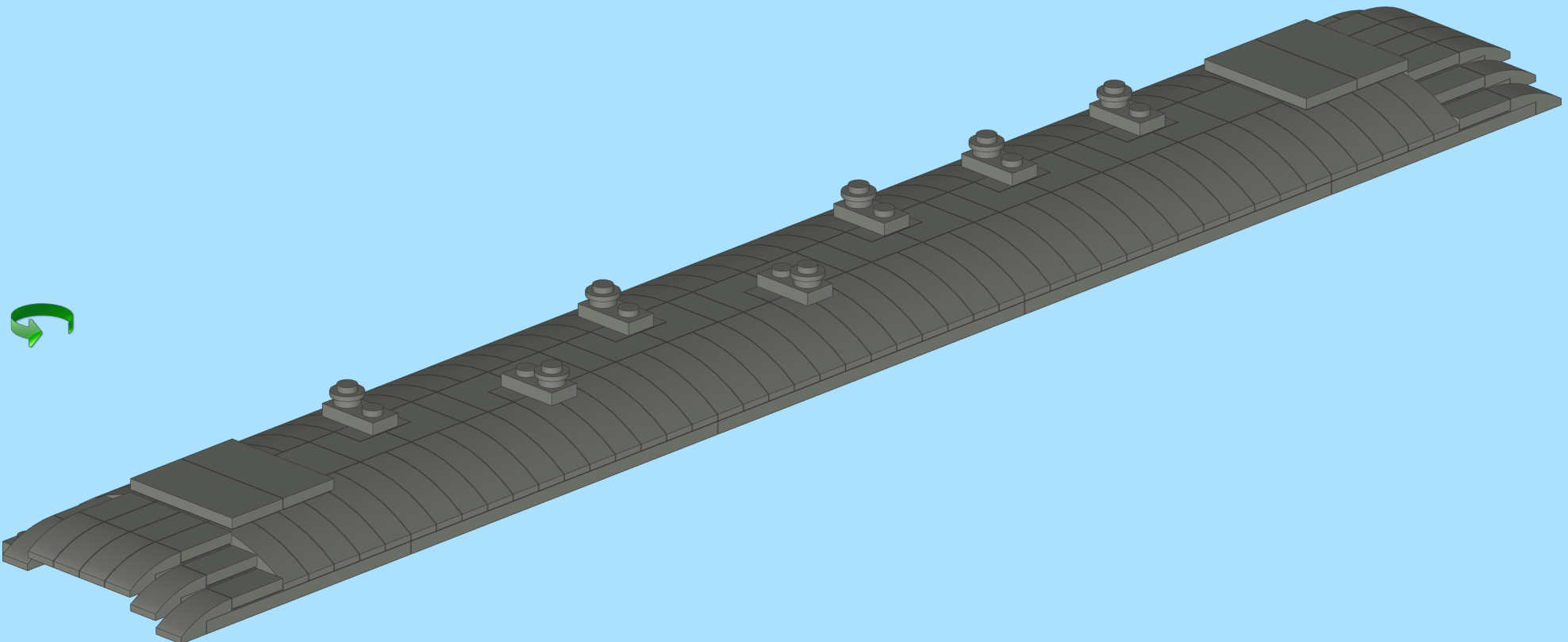
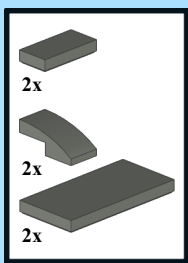

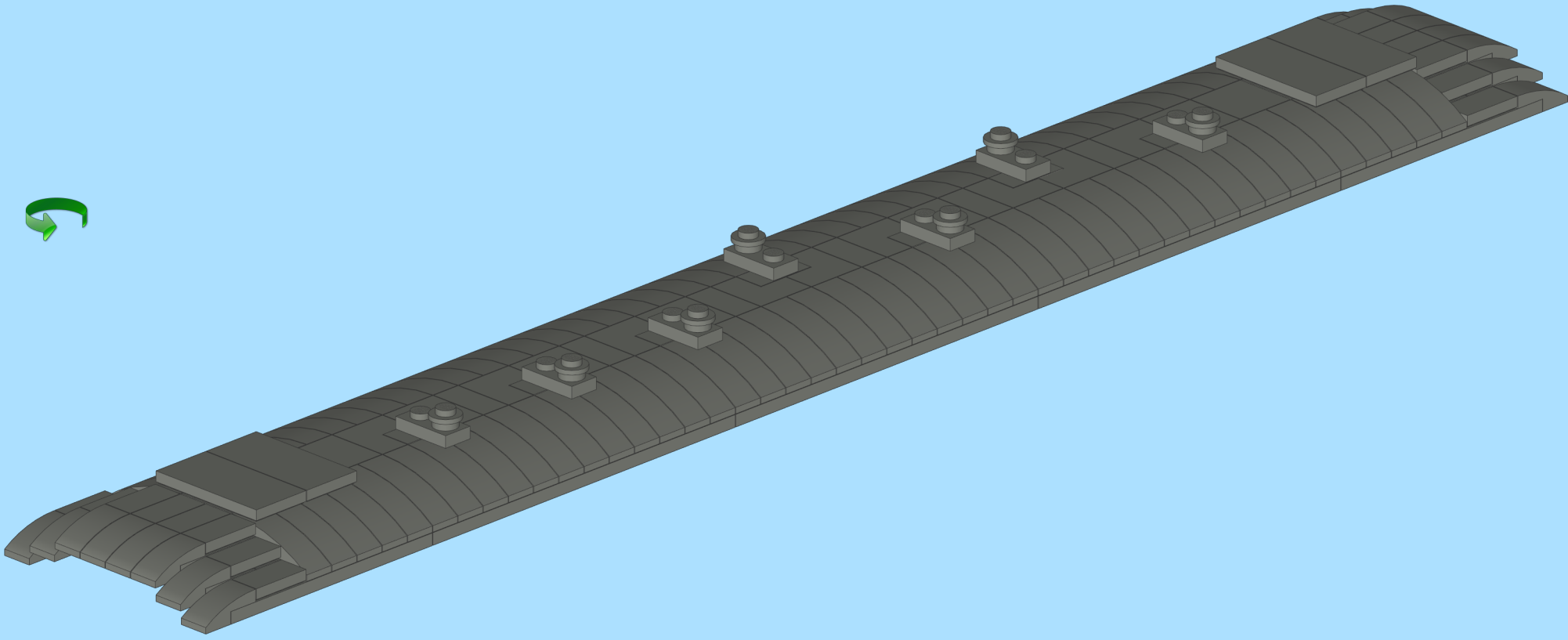
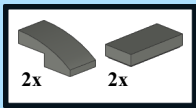

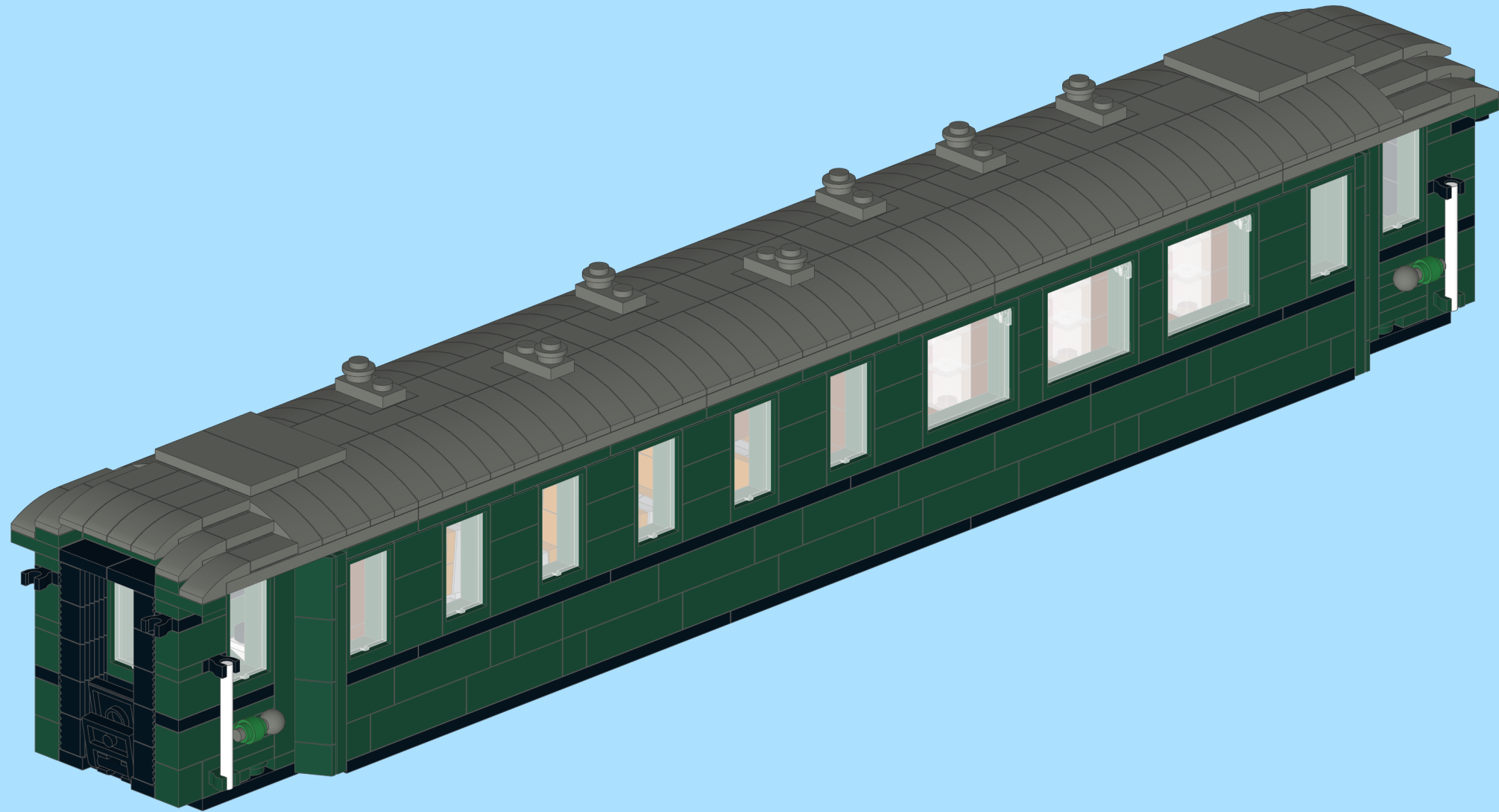

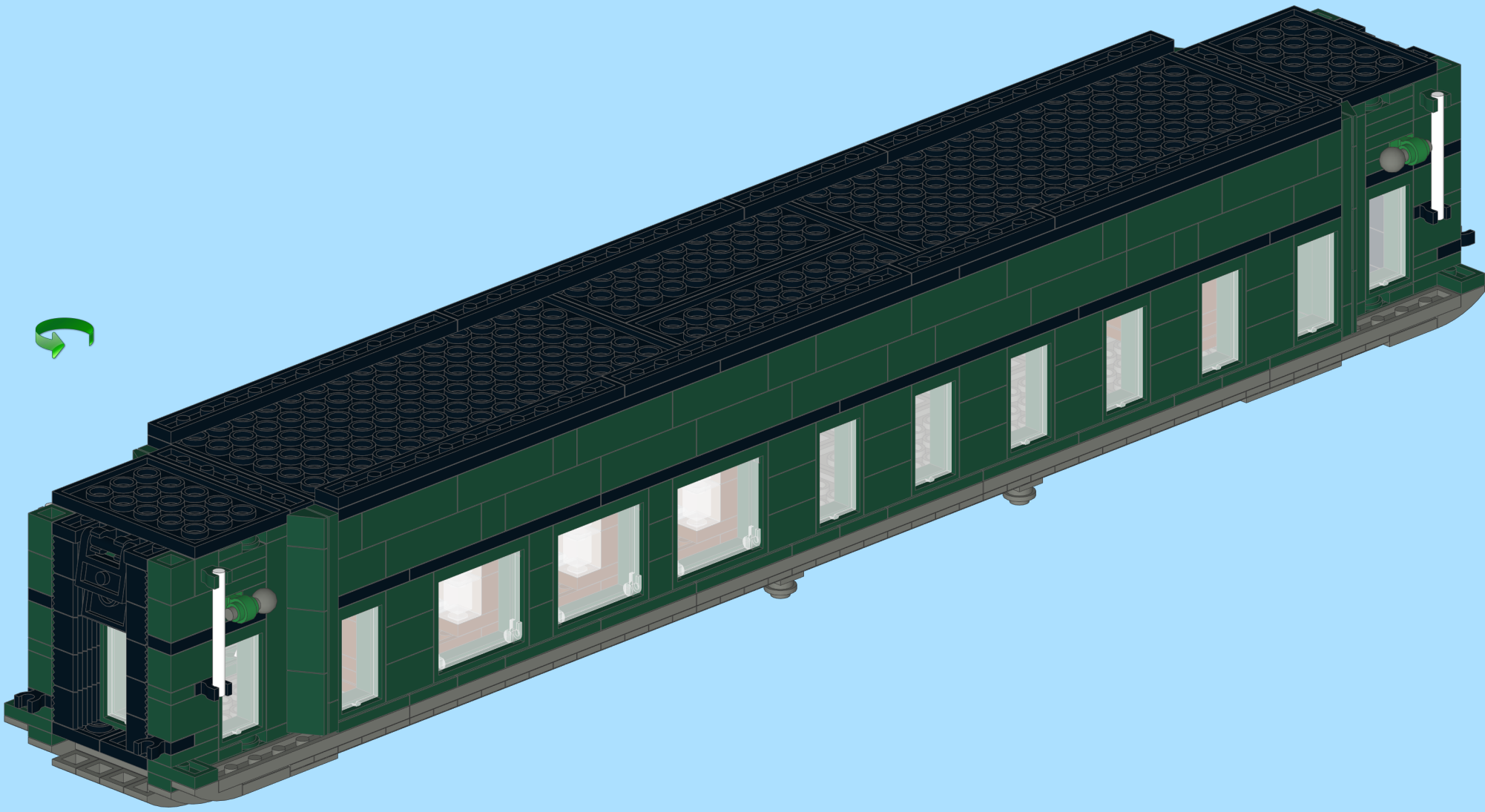
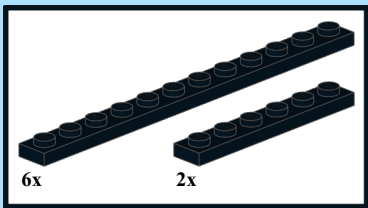

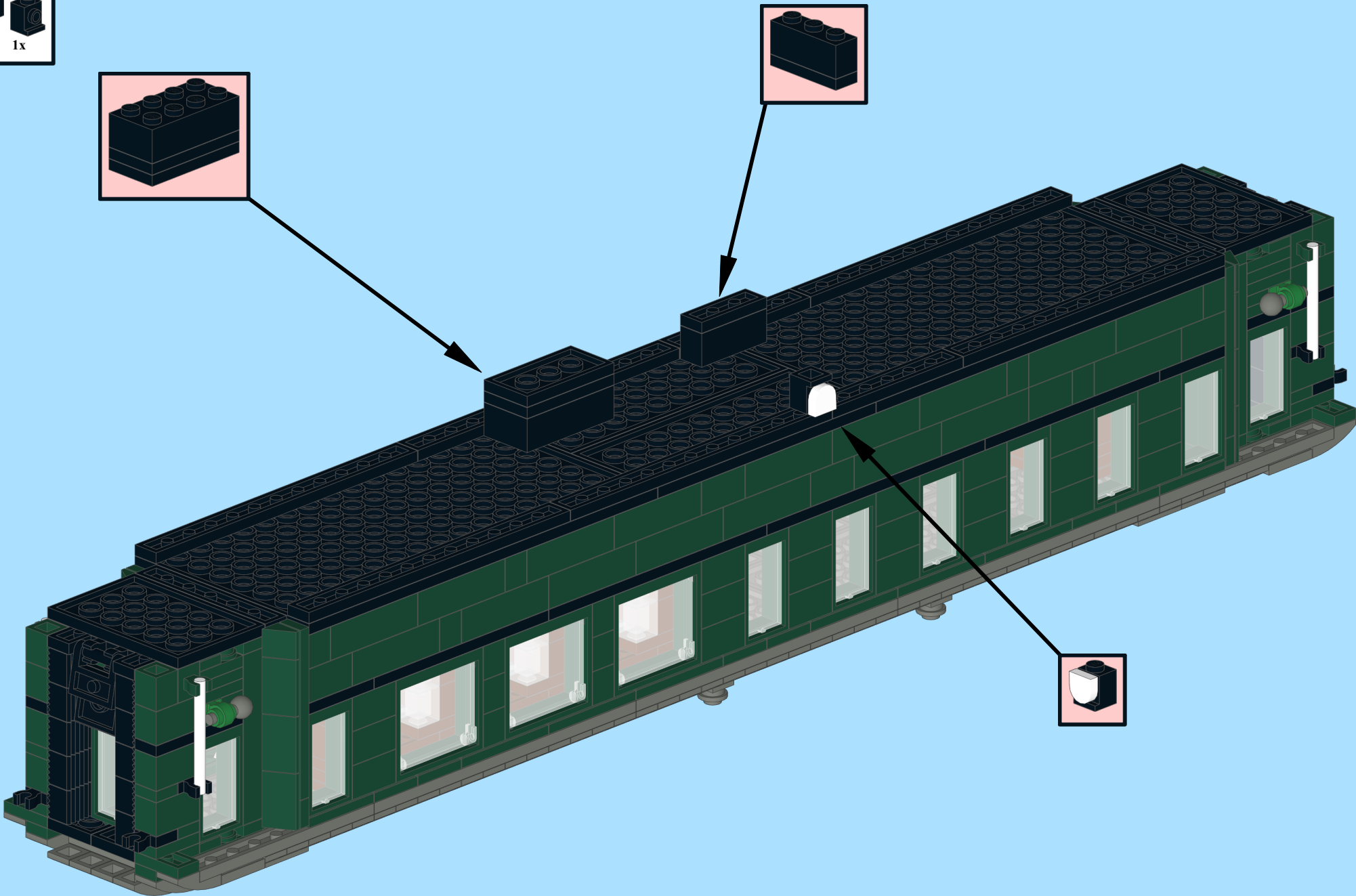
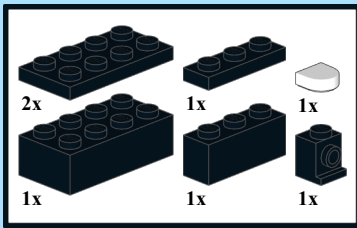

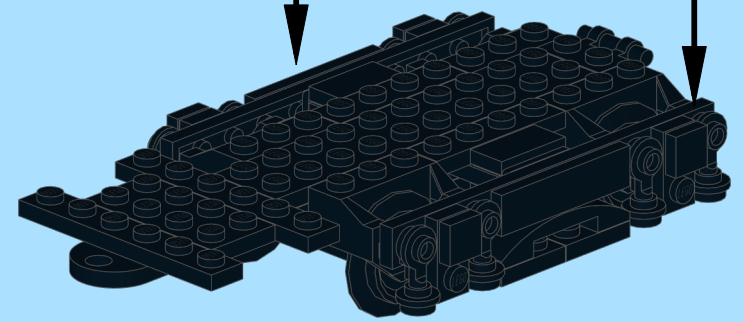
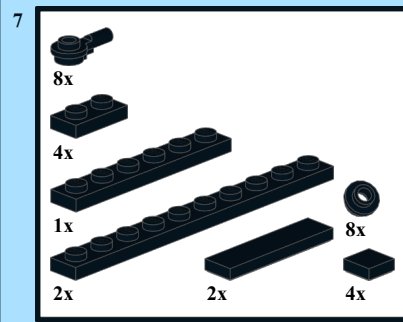
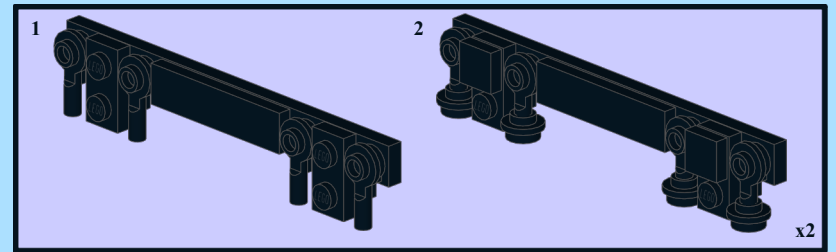
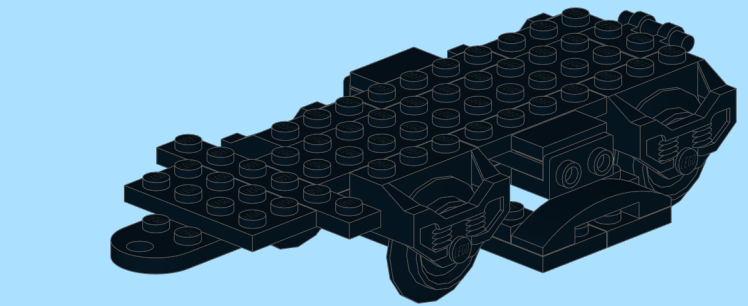
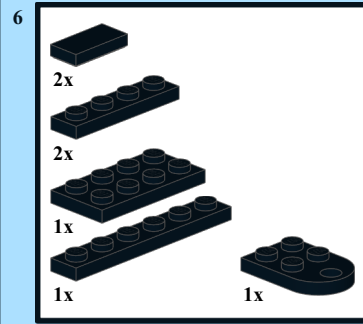
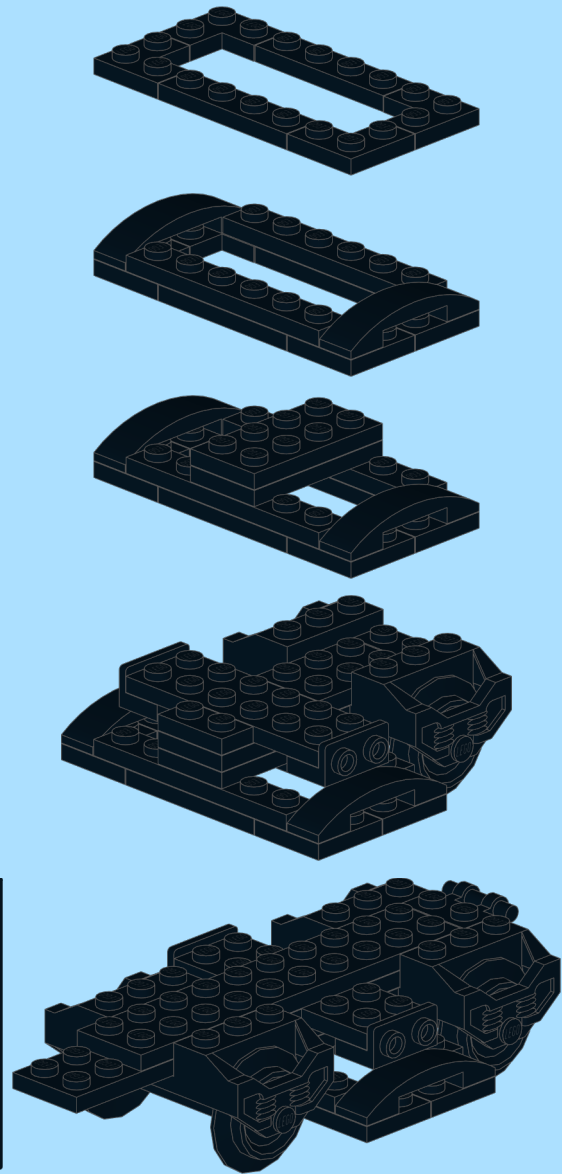
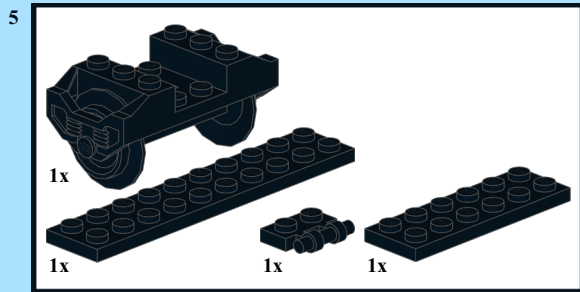
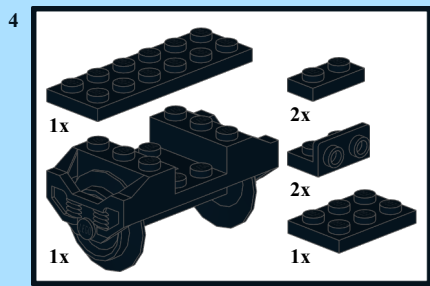
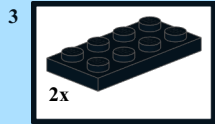
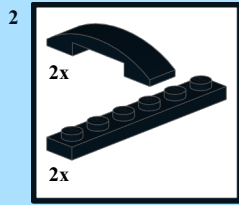
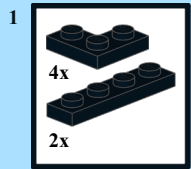

8

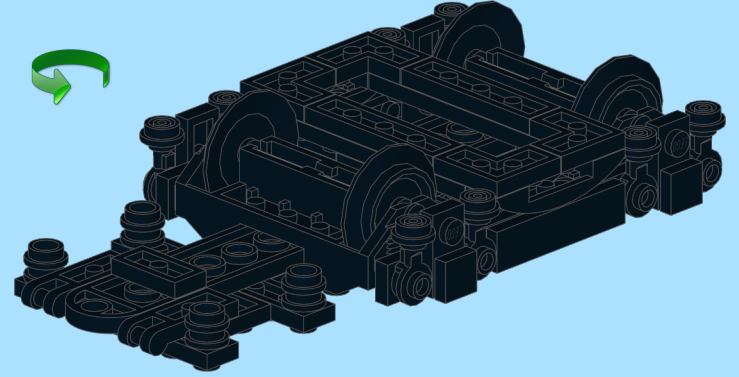
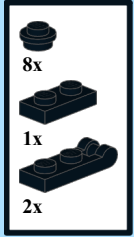

11

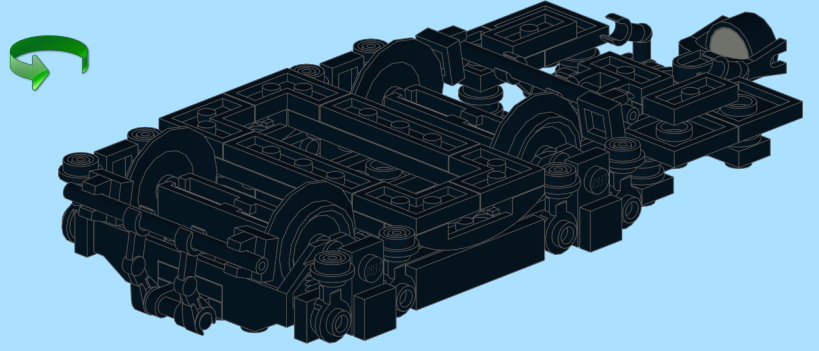
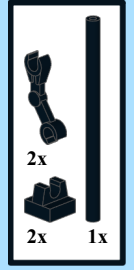

9

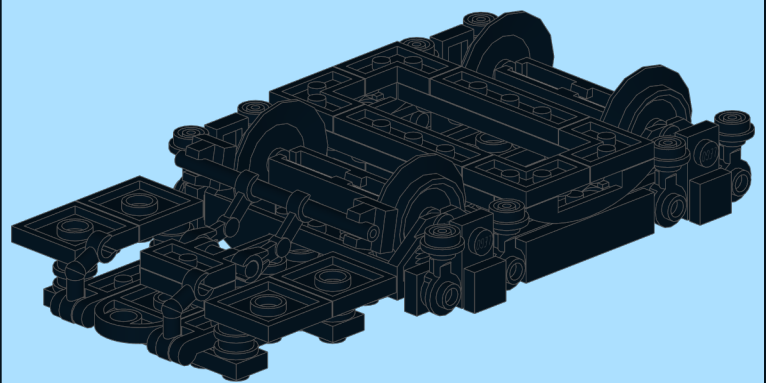
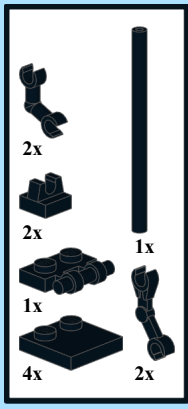

12

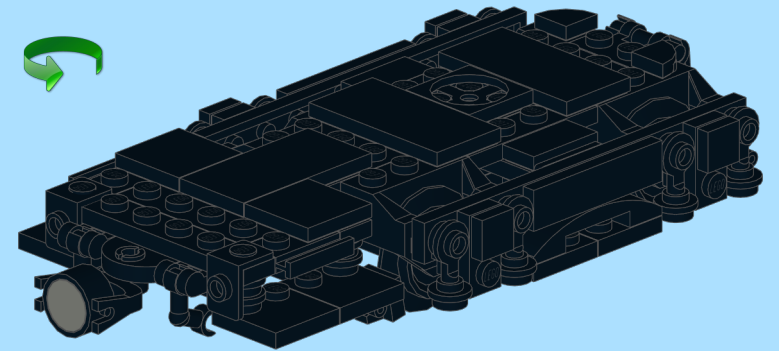
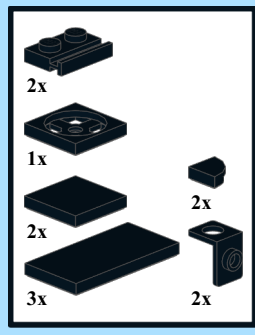

10

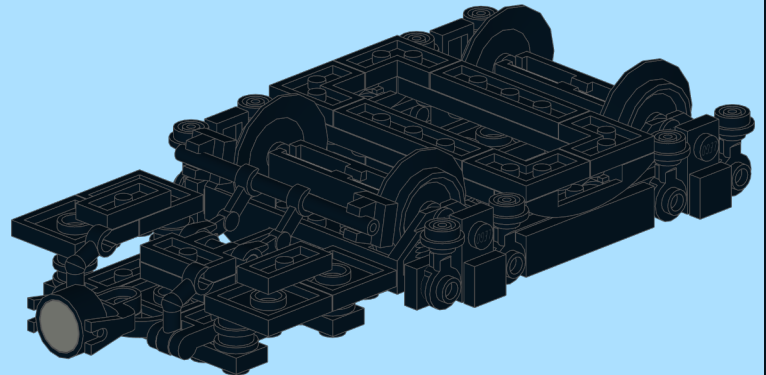
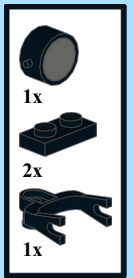

13

