

# Bi24 DRG passenger car 2. class

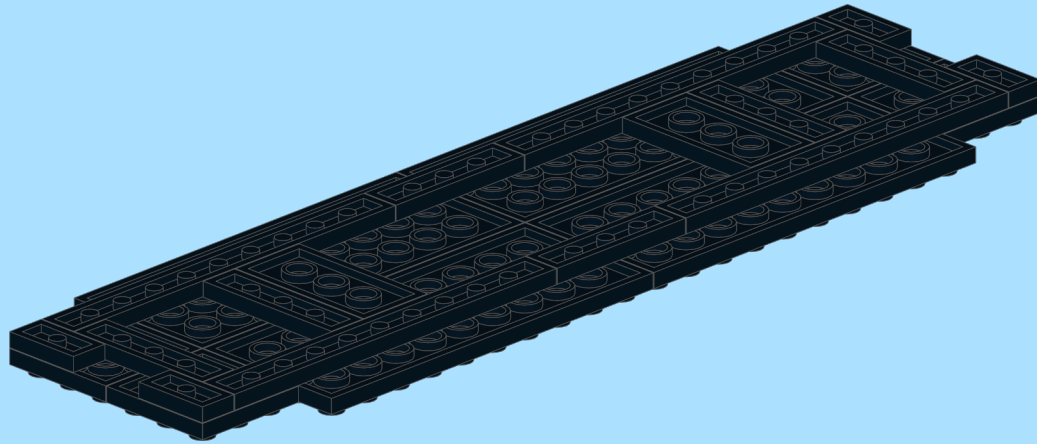

Instructions by: Filip Pienkowski  
Update: 2018-10-25

INSTRUCTION BY  
**KNUD ALBRECHTSEN**  
[www.snakebyte.dk/lego](http://www.snakebyte.dk/lego)

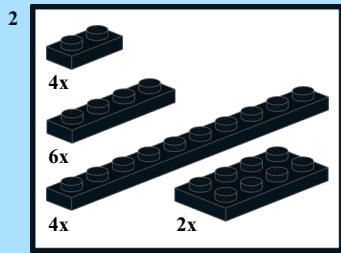
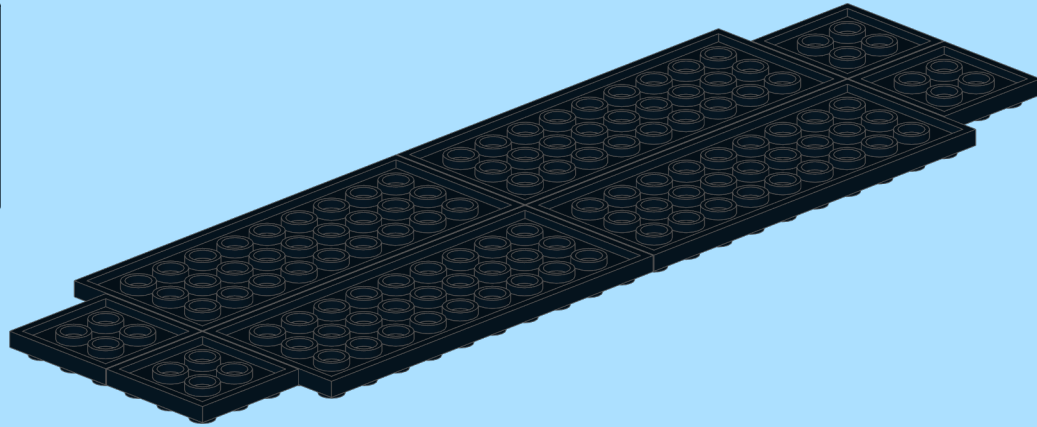
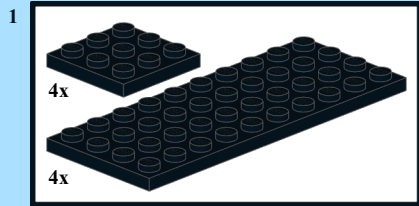



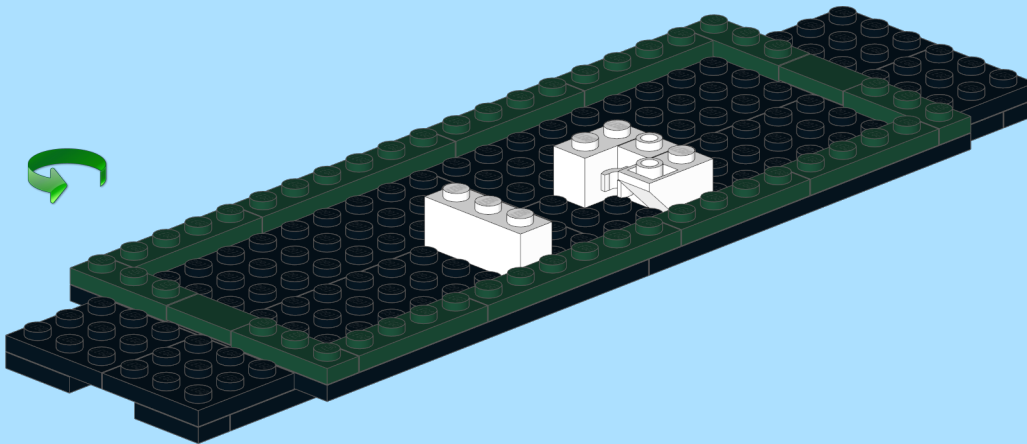
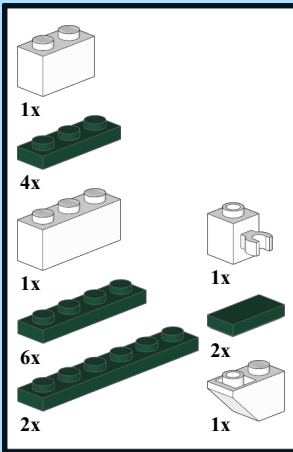

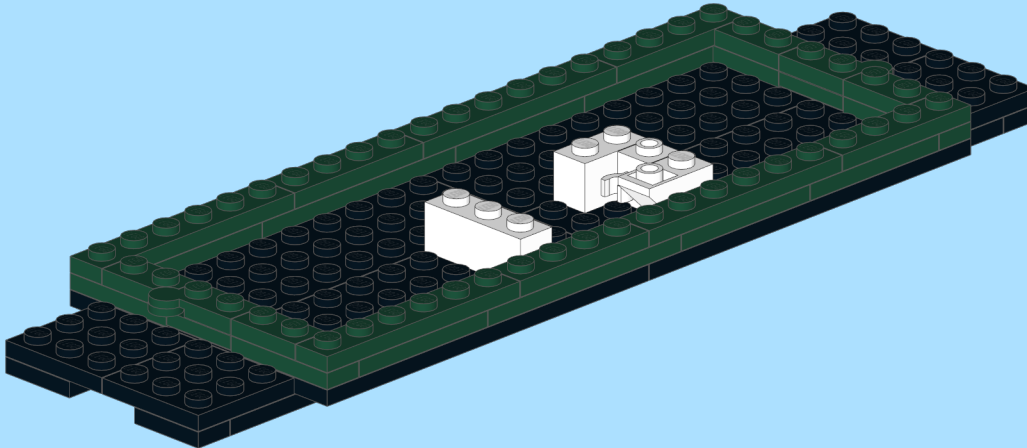
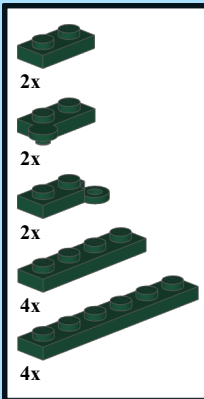

3



4



- 5
-  1x
  -  1x
  -  4x
  -  4x
  -  4x



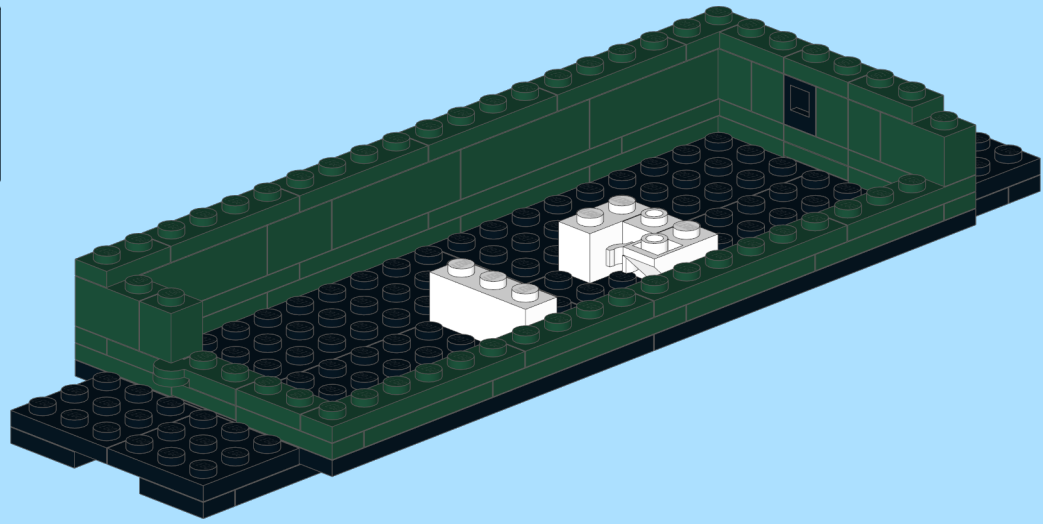
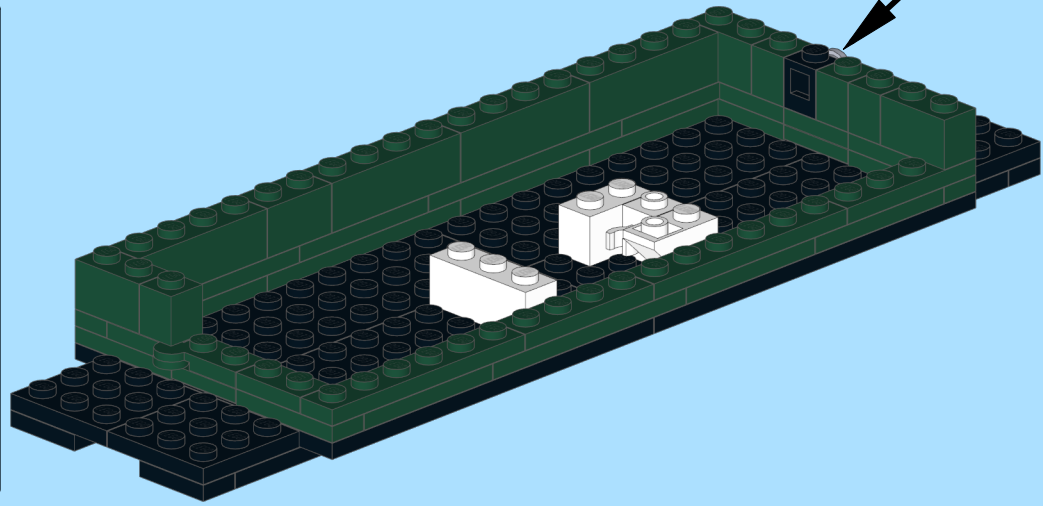
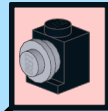

- 6
-  5x
  -  4x

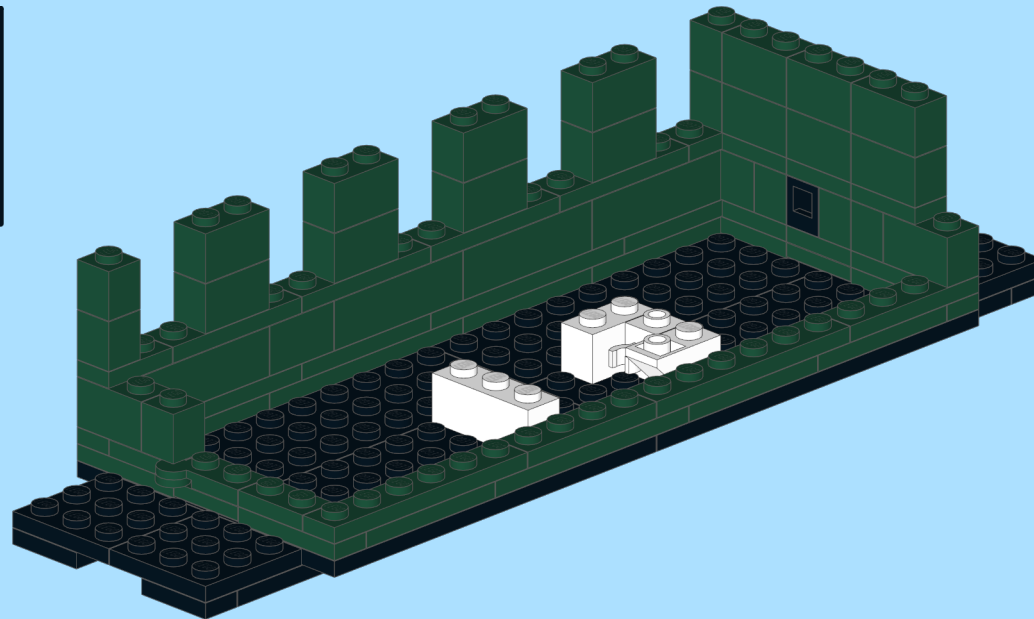
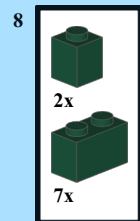
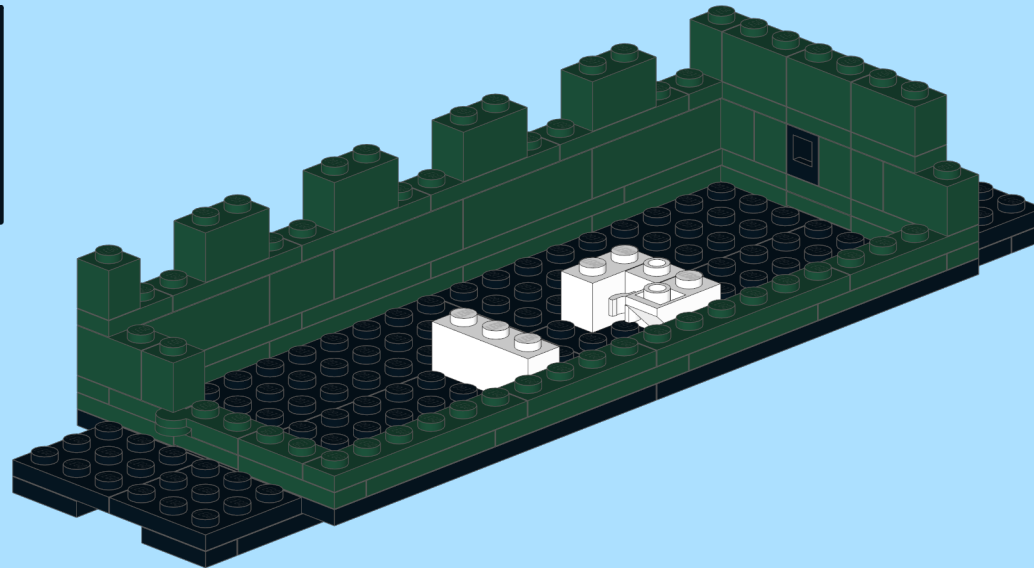
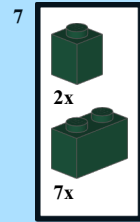







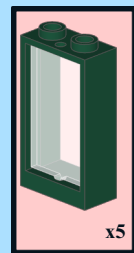
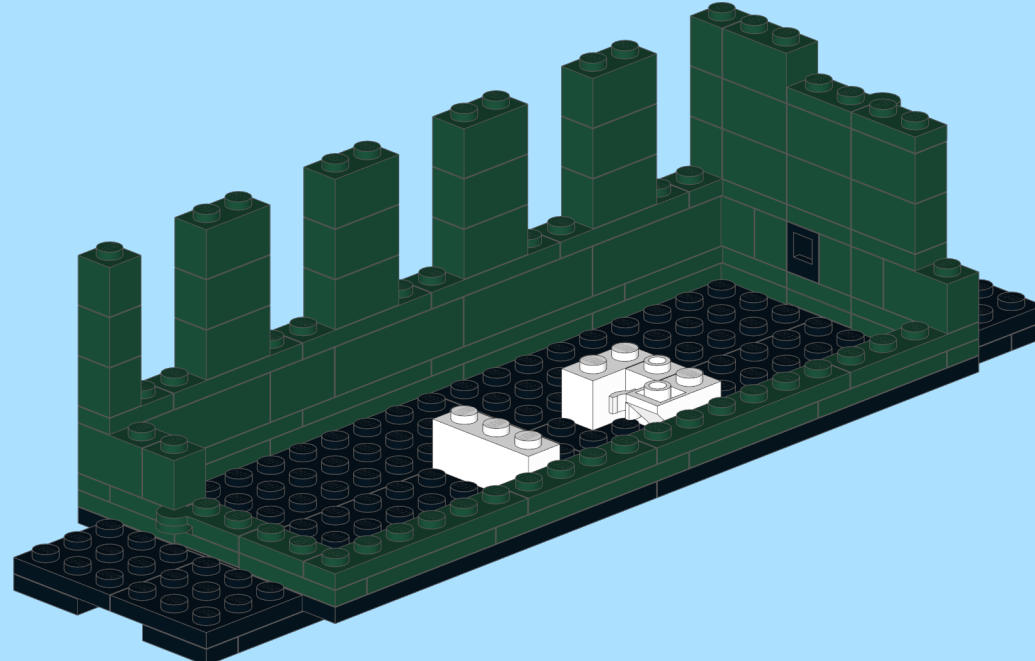

9

-  2x
-  5x
-  1x
-  1x







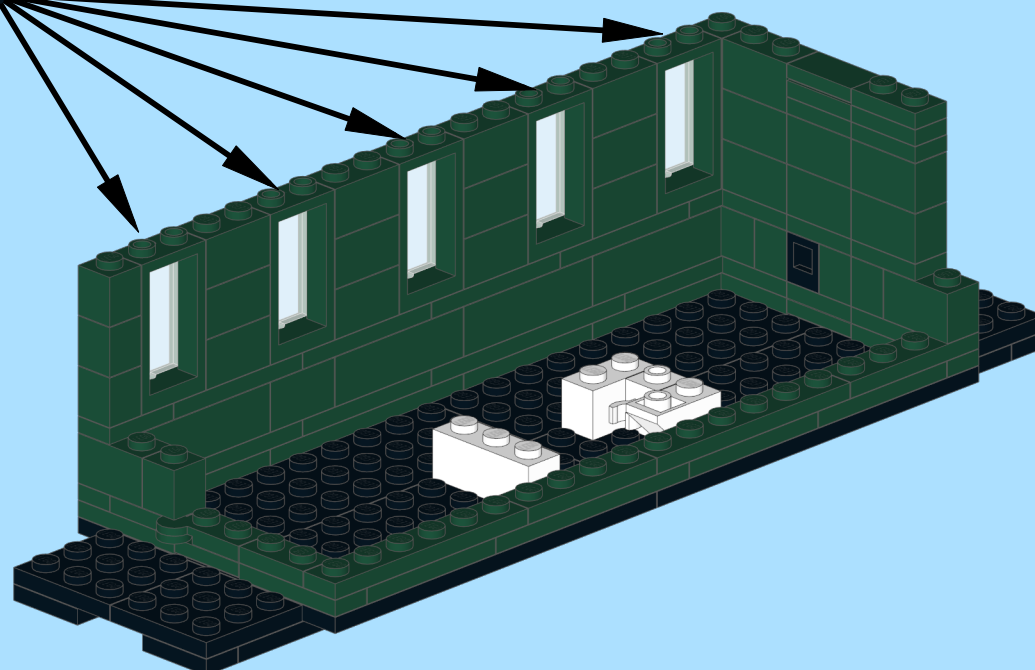

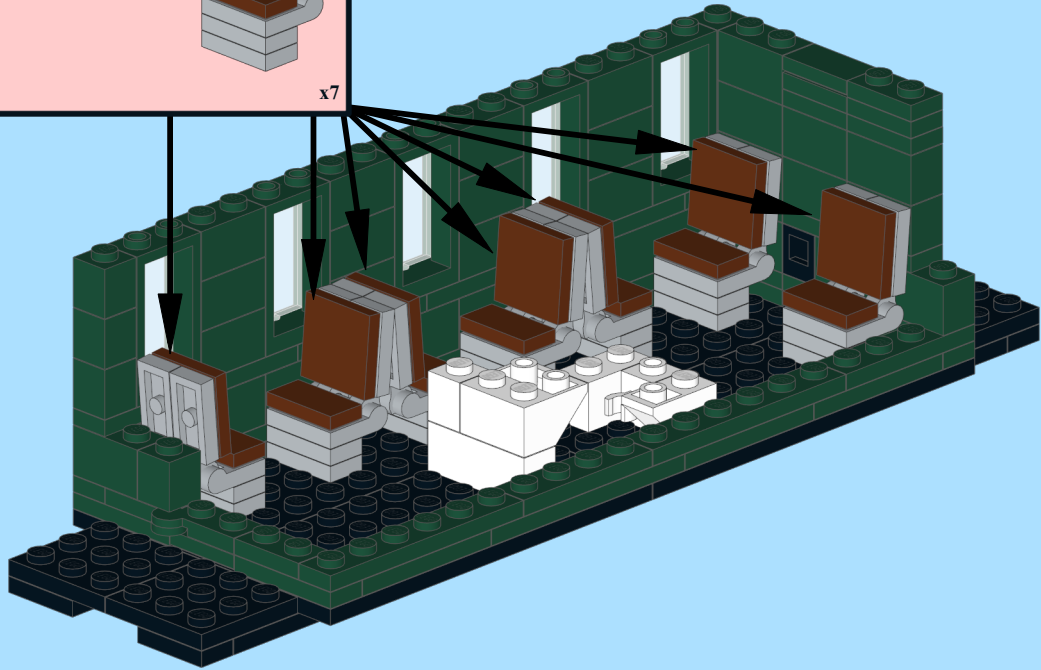
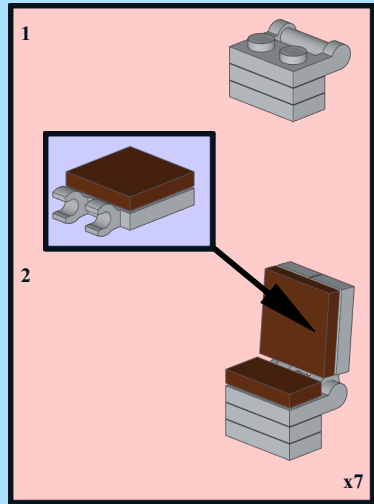
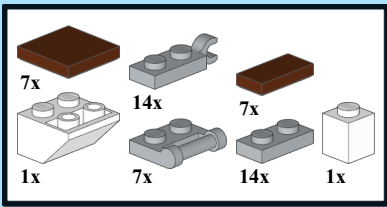

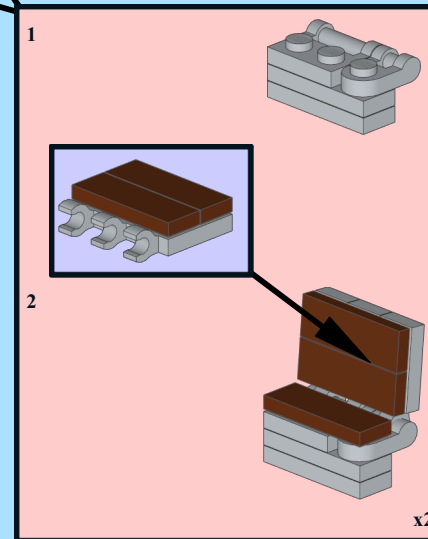
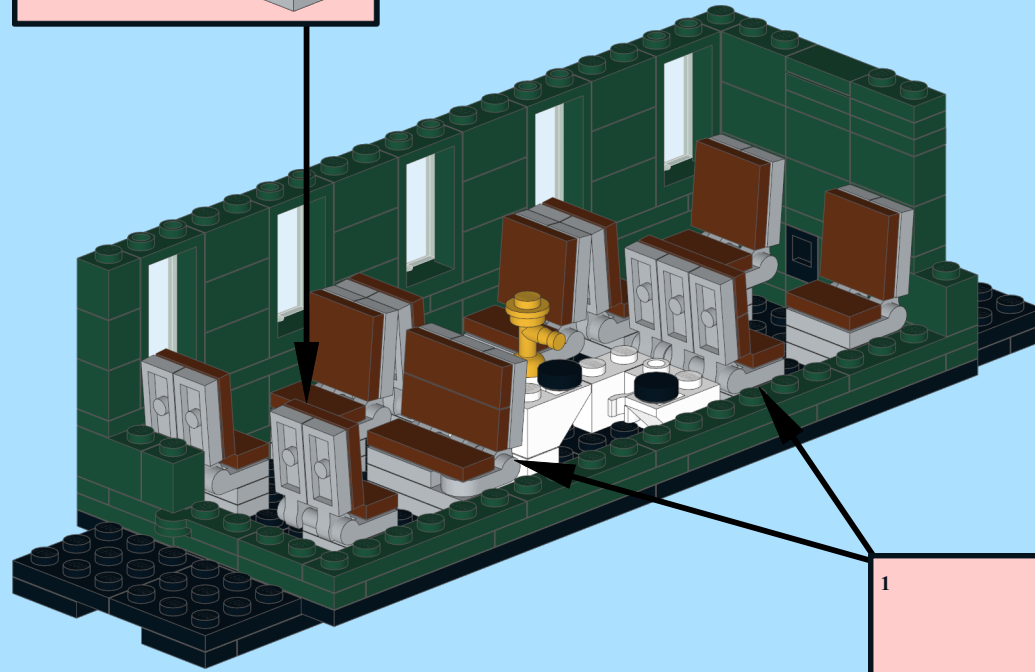
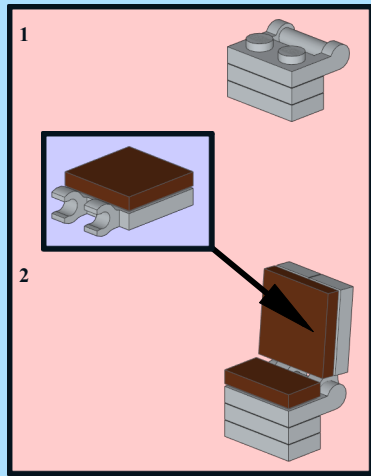
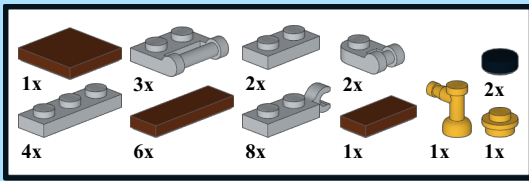
10

-  5x
-  1x
-  3x
-  5x





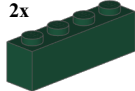

- 13
-  1x
  -  1x
  -  2x
  -  1x
  -  2x
  -  2x
  -  4x
  -  1x

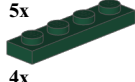

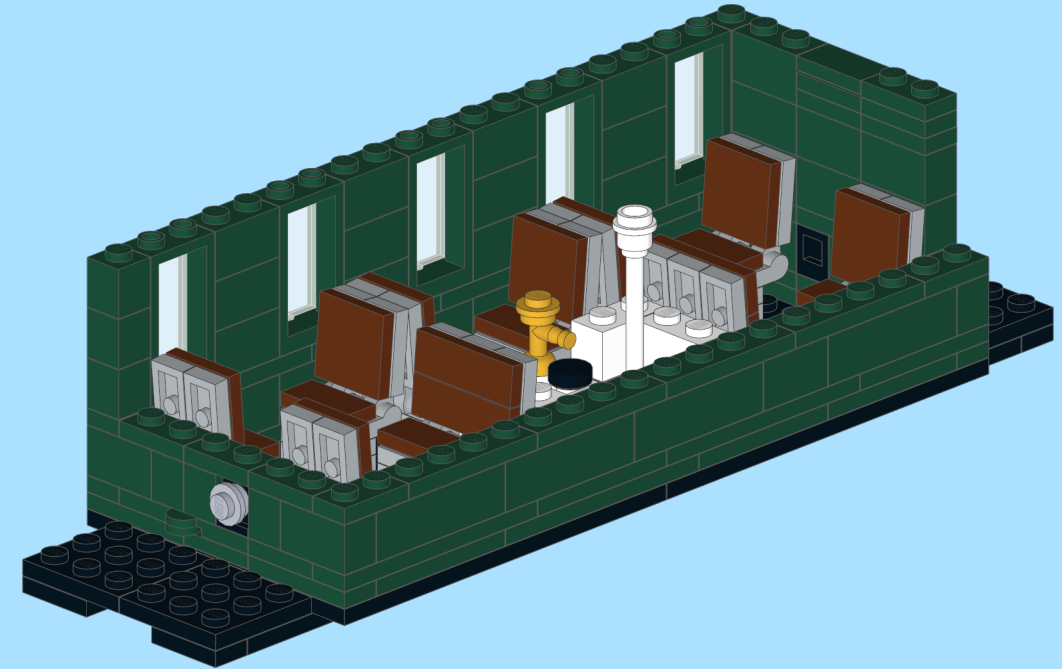
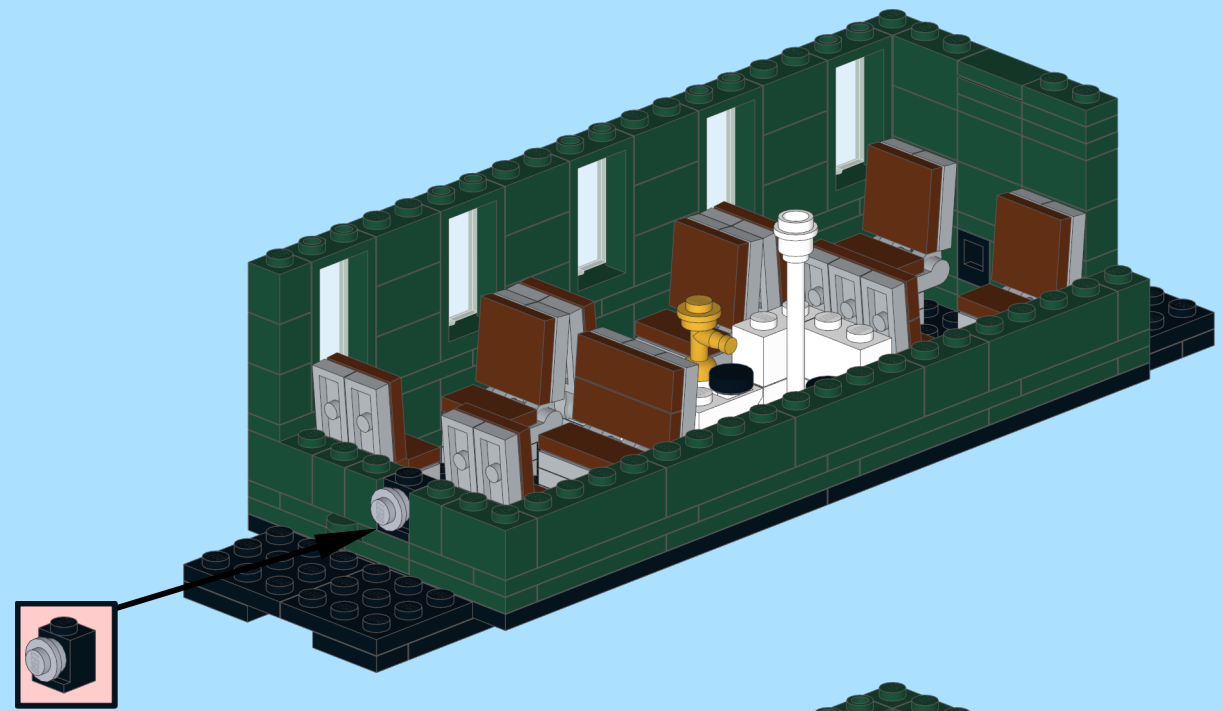

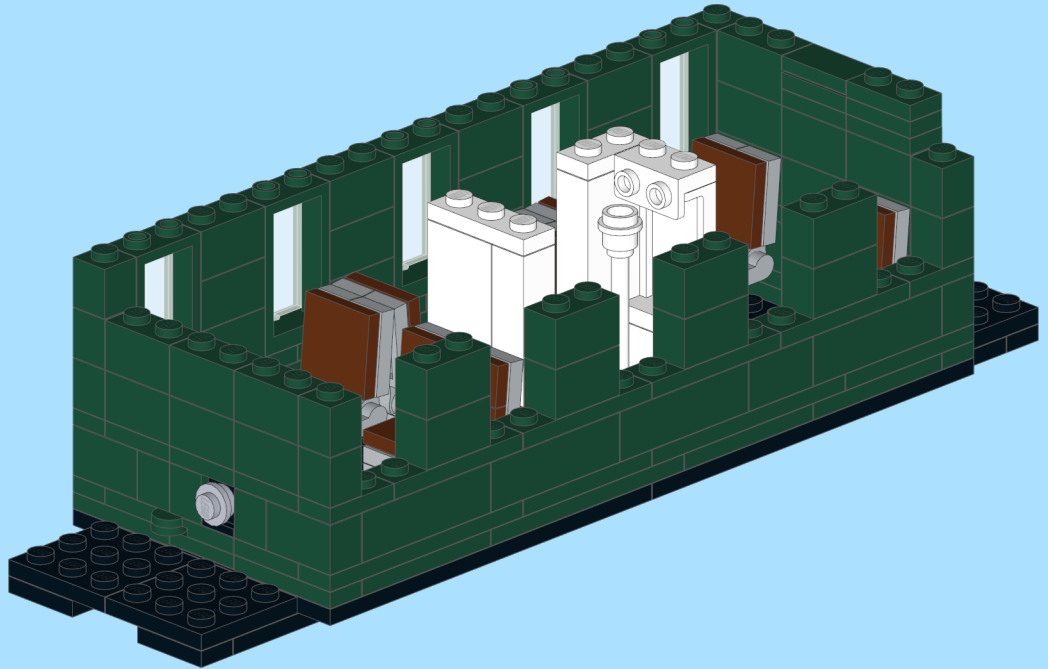
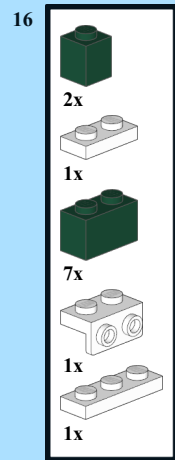
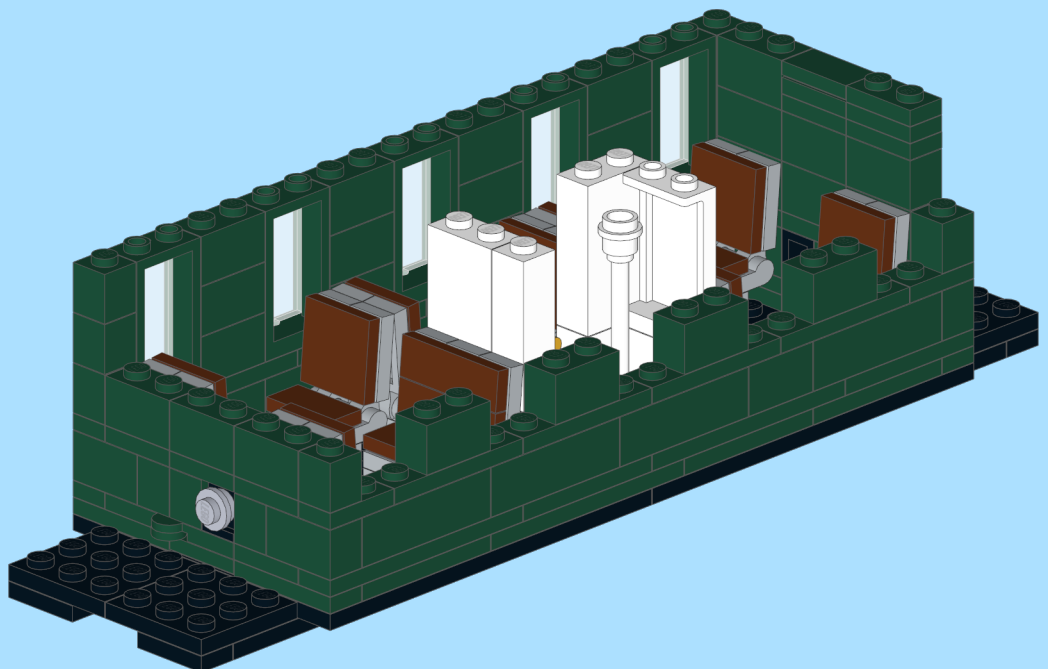
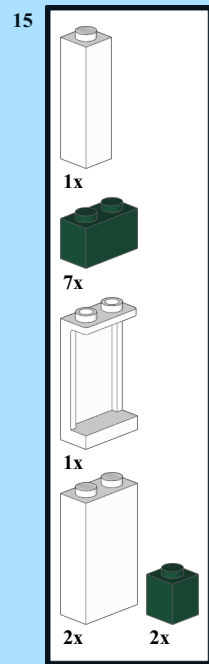

- 14
-  5x
  -  4x











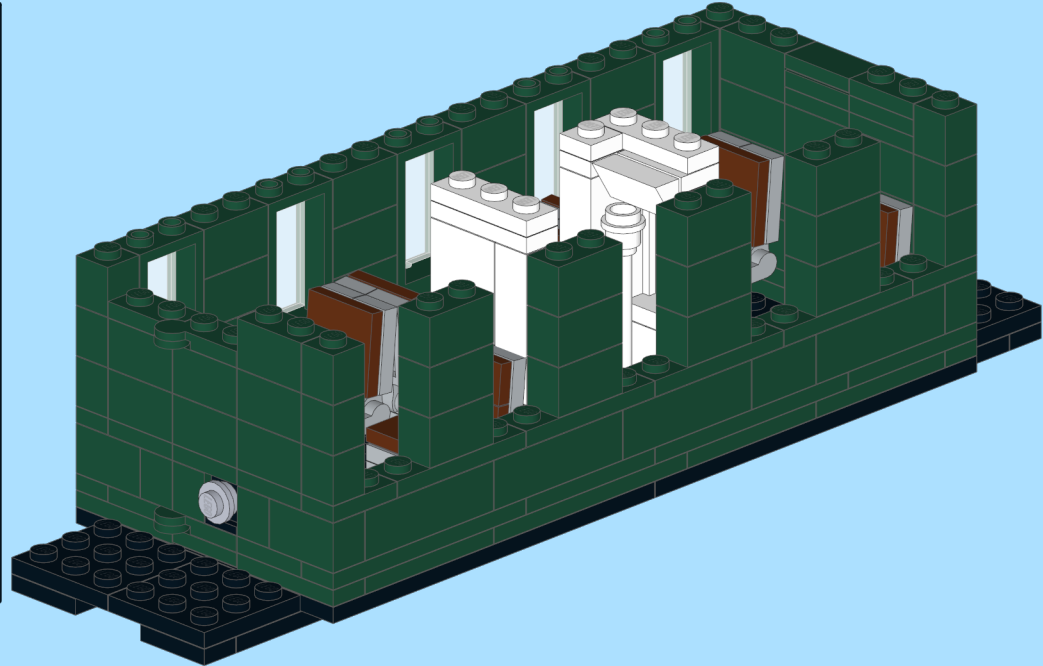

17

-  1x
-  2x
-  1x
-  5x
-  1x
-  1x
-  2x







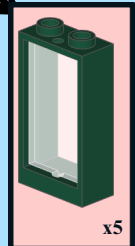
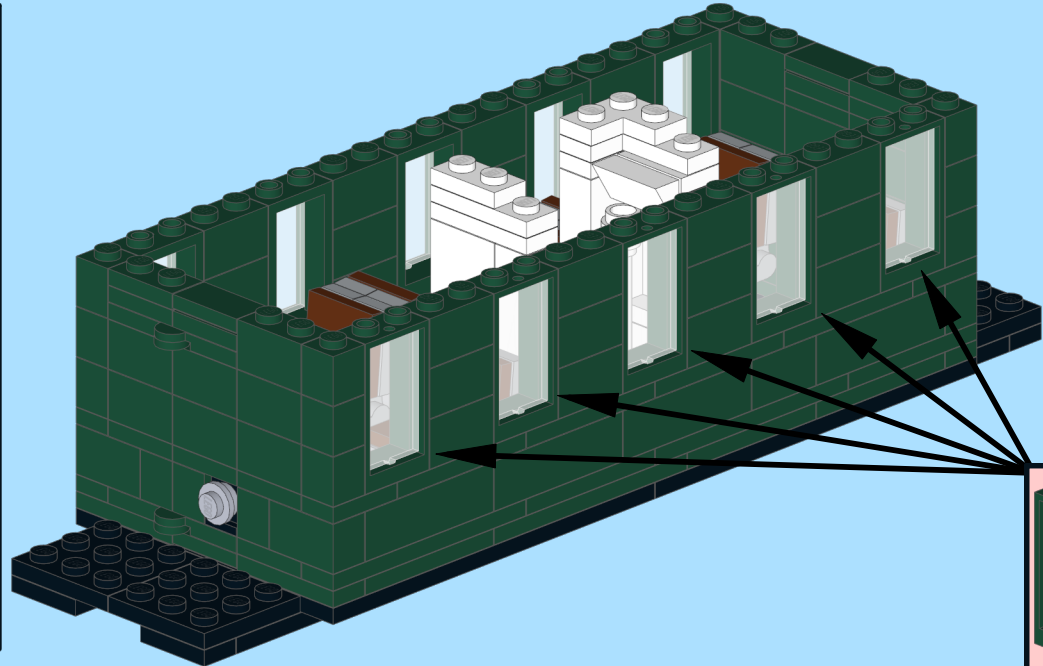

18

-  5x
-  1x
-  3x
-  1x
-  5x
-  1x





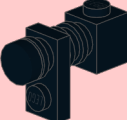

19

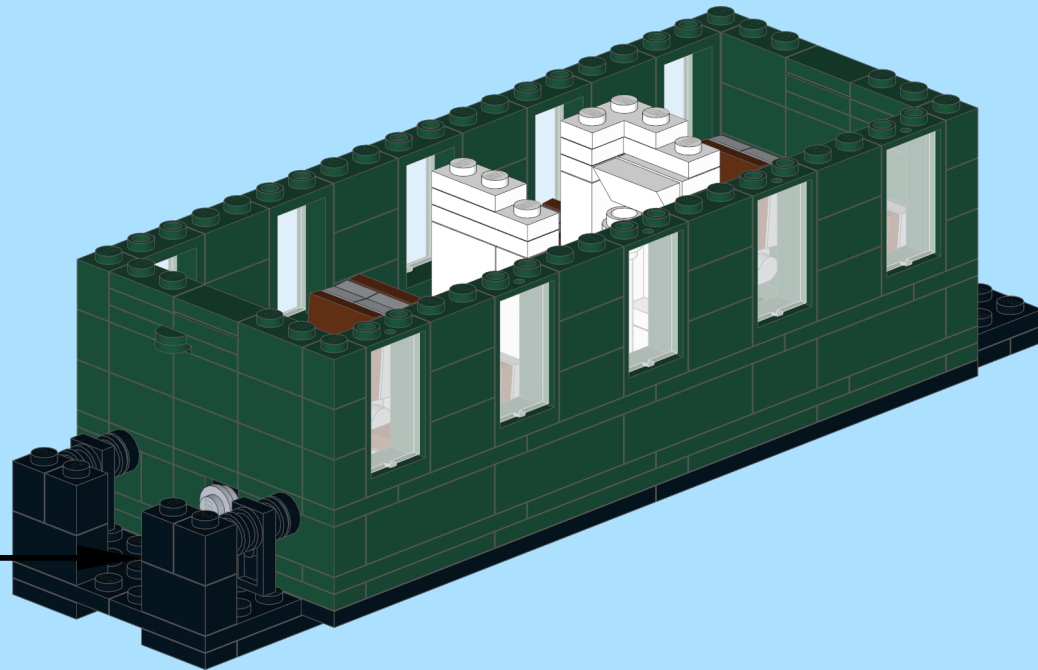
-  2x
-  6x
-  2x
-  2x
-  2x
-  2x

- 1 
  - 2 
- x2

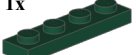

20

-  2x
-  2x
-  1x
-  1x
-  2x
-  1x

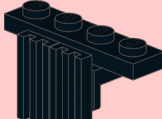
- 1 
- 2 

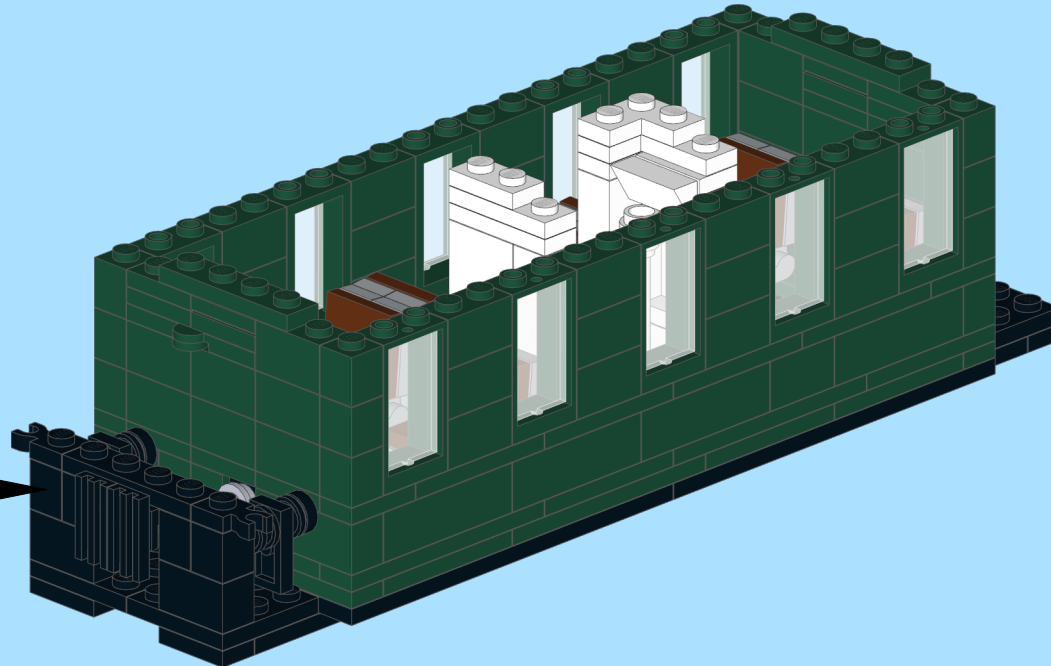

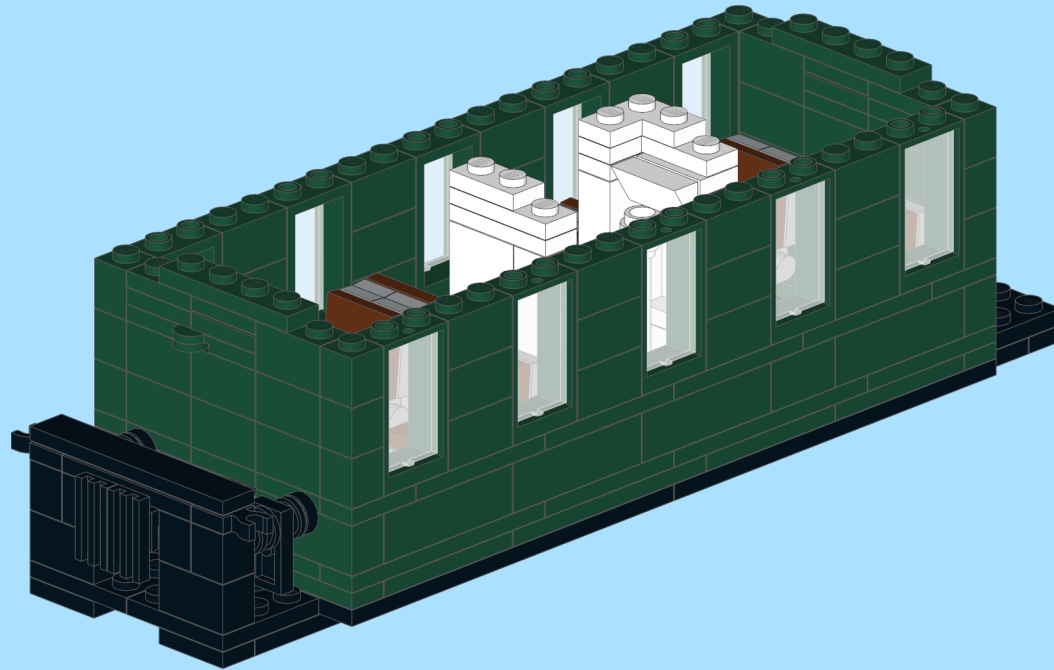
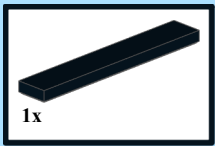

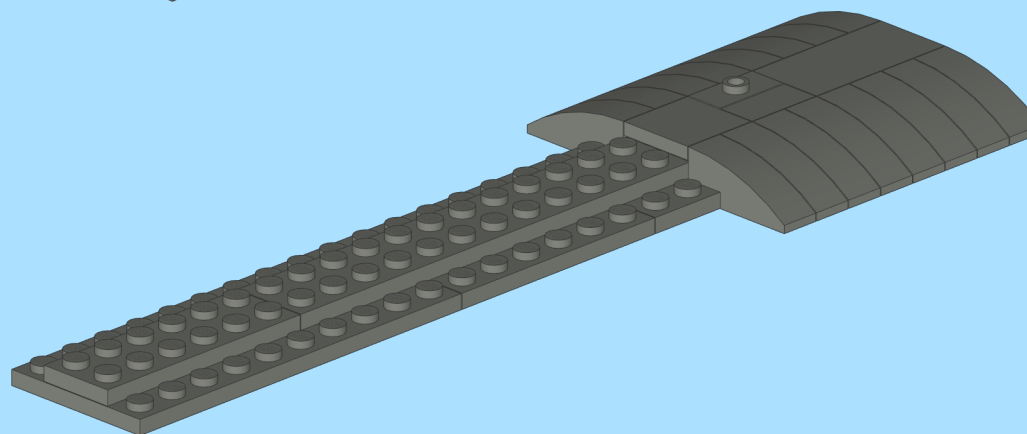
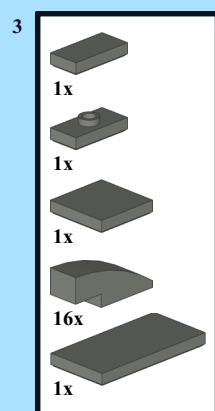
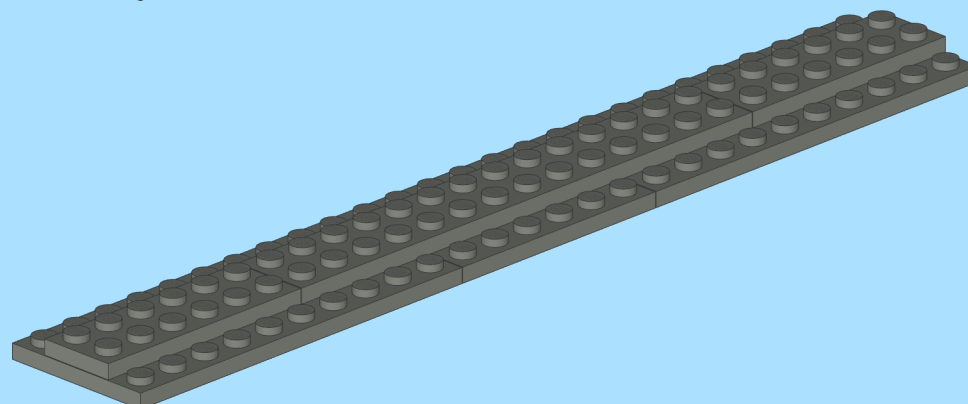
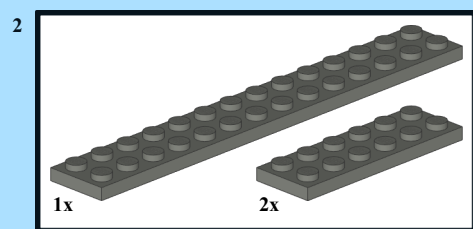
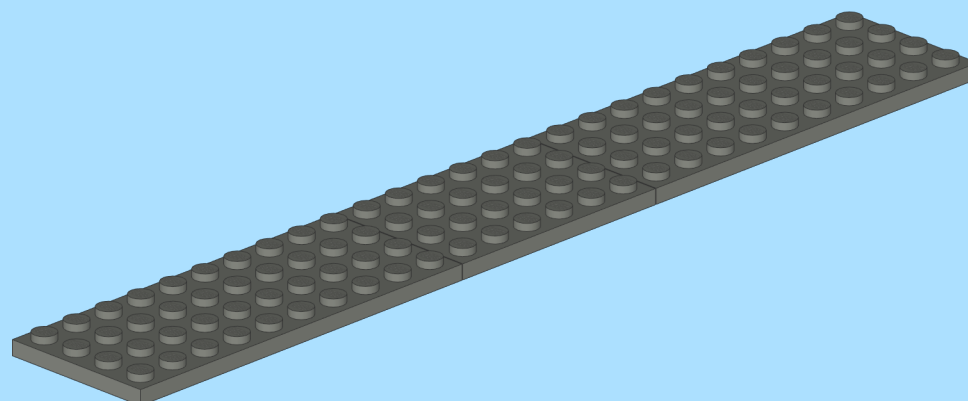
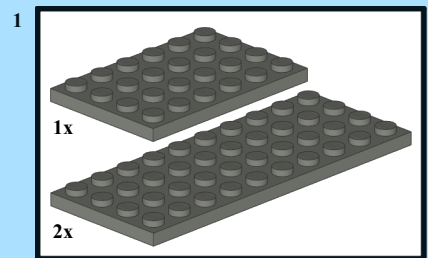

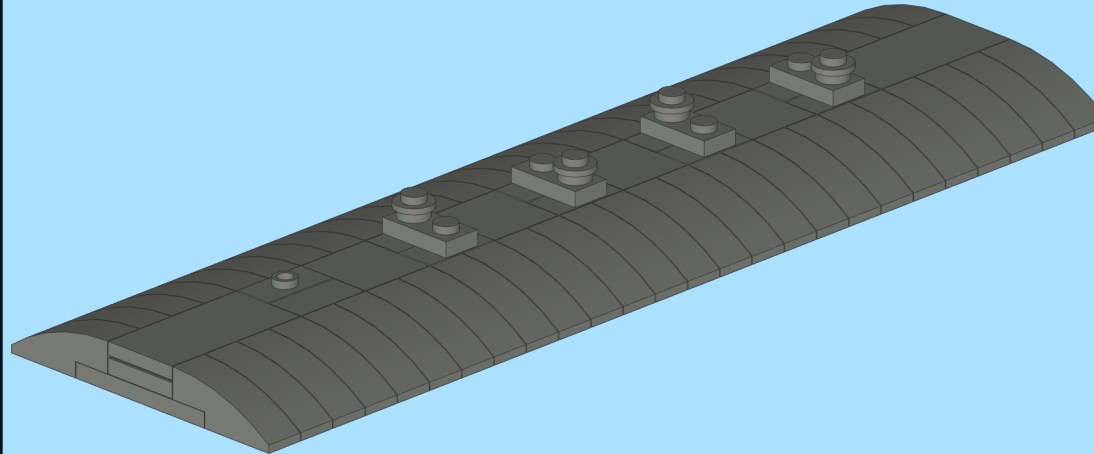
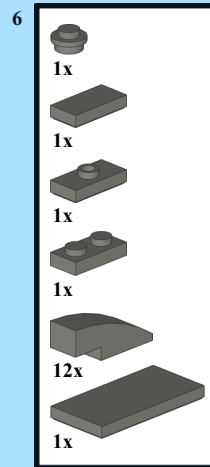
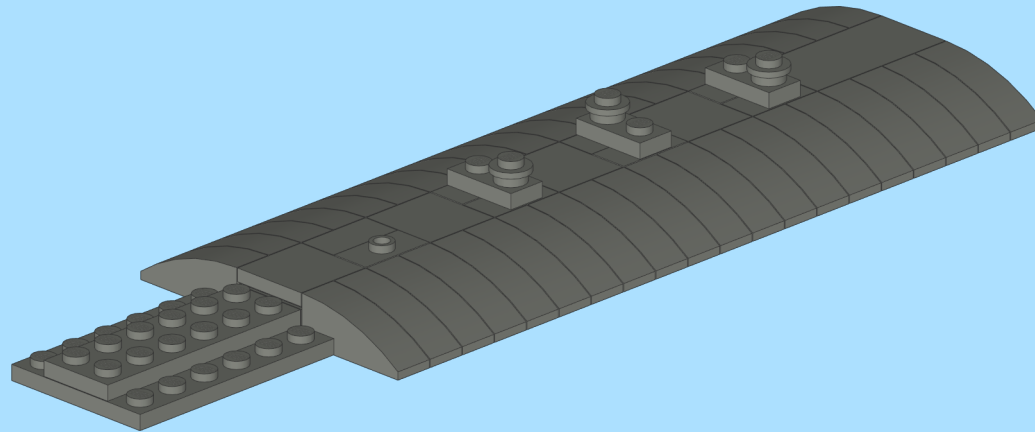
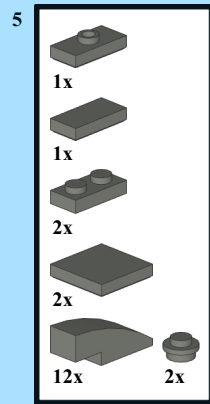
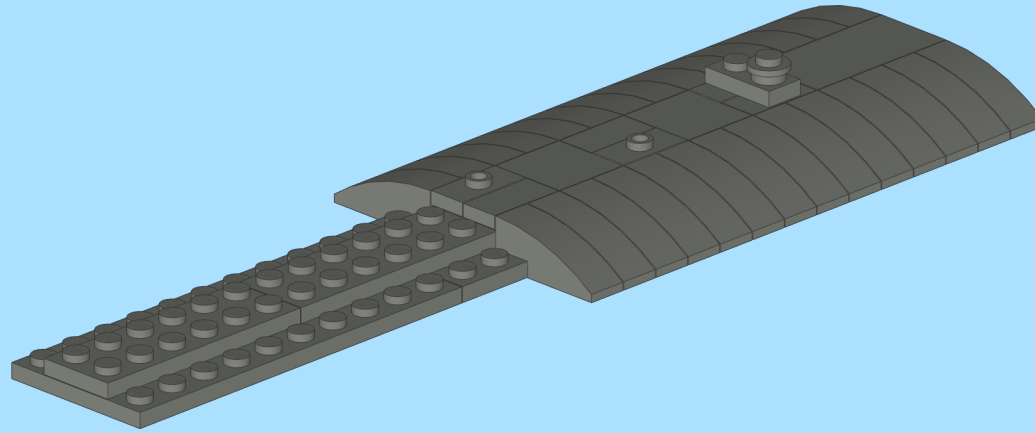
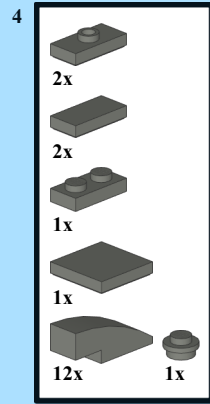

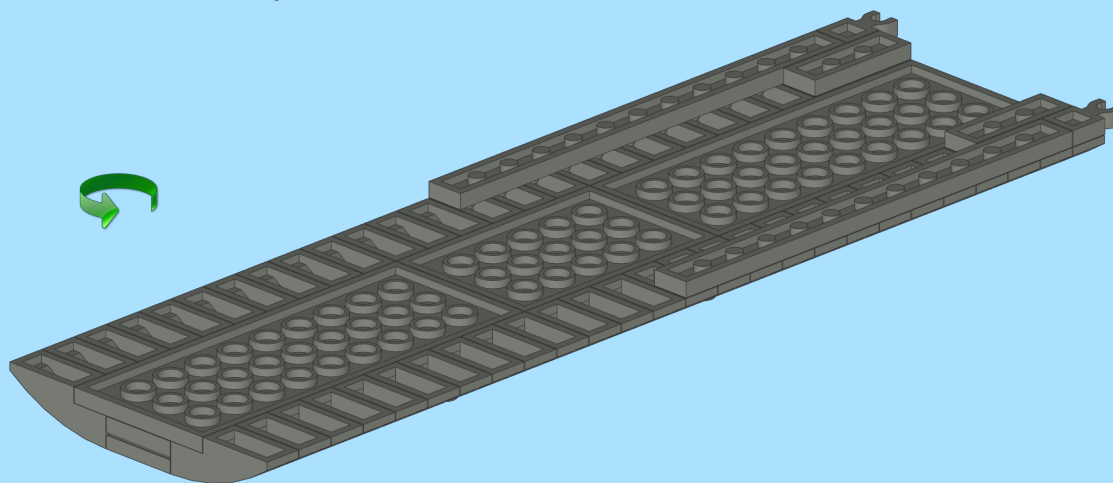
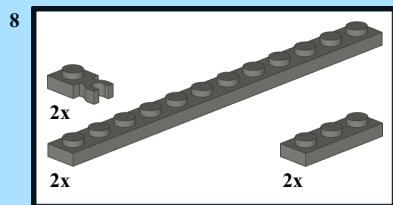
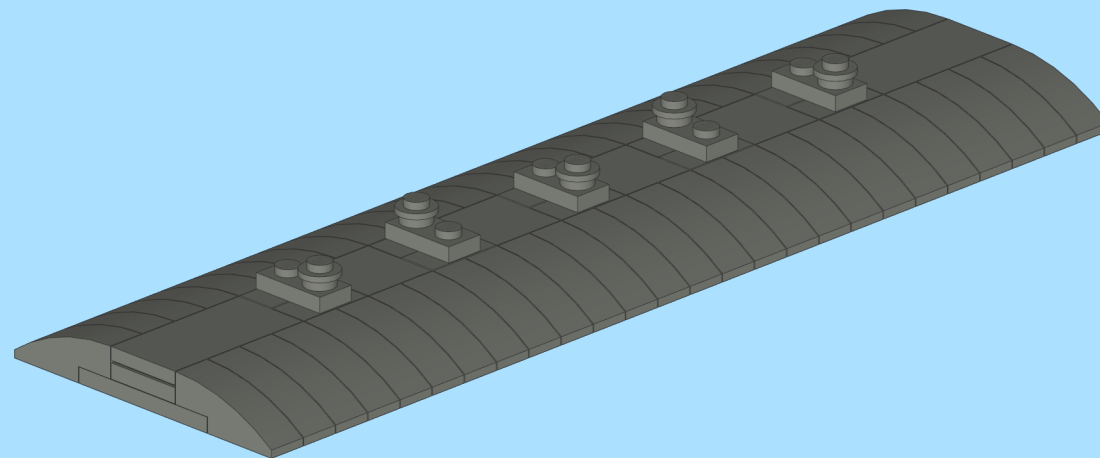
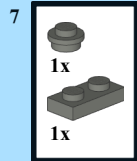



9

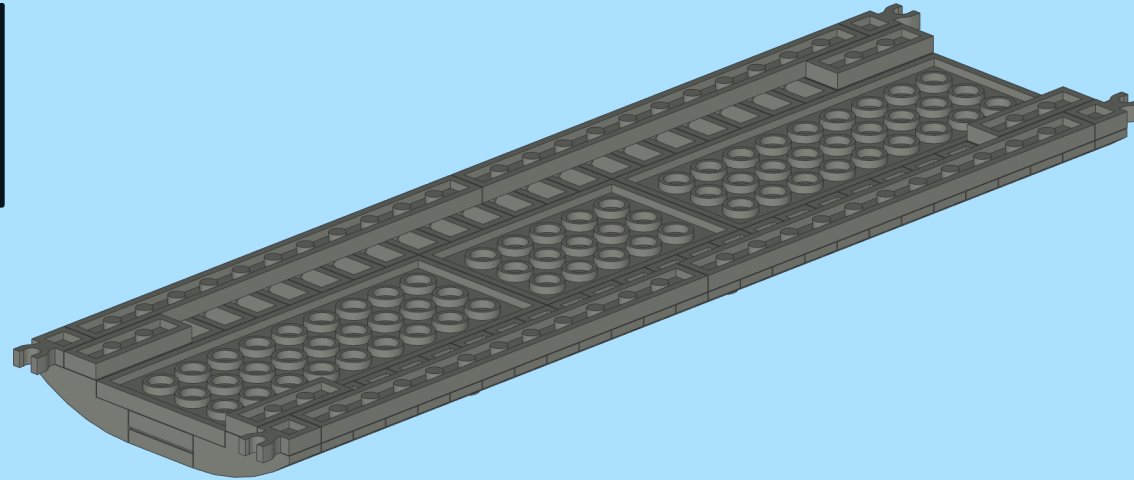
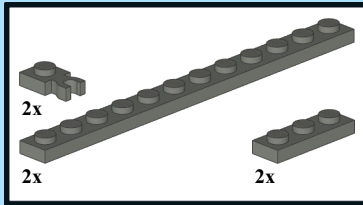

10

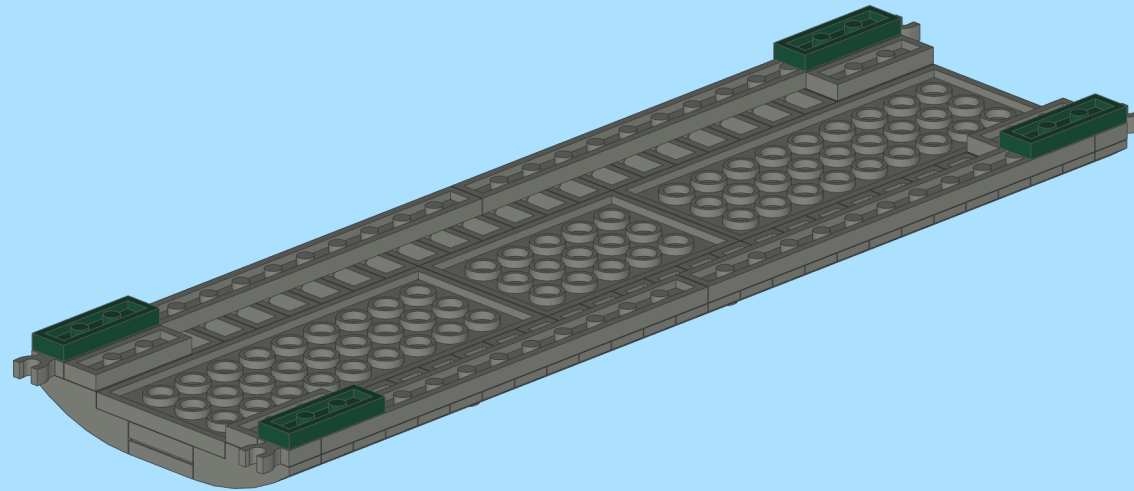
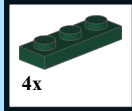



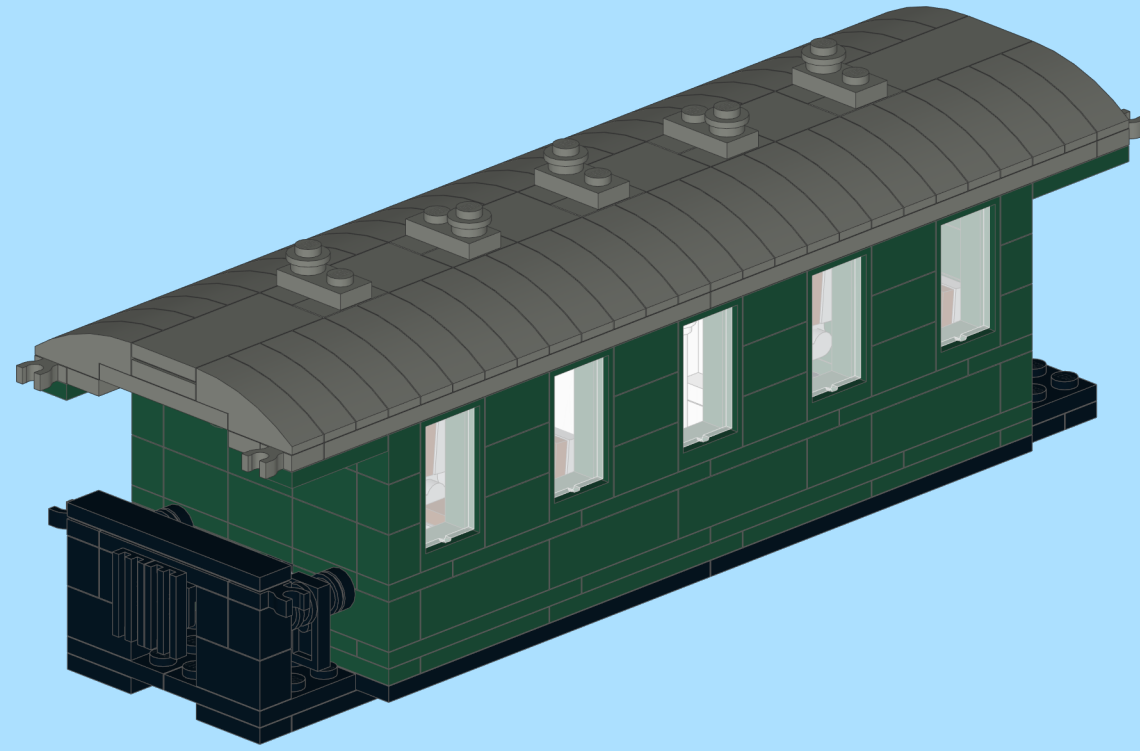

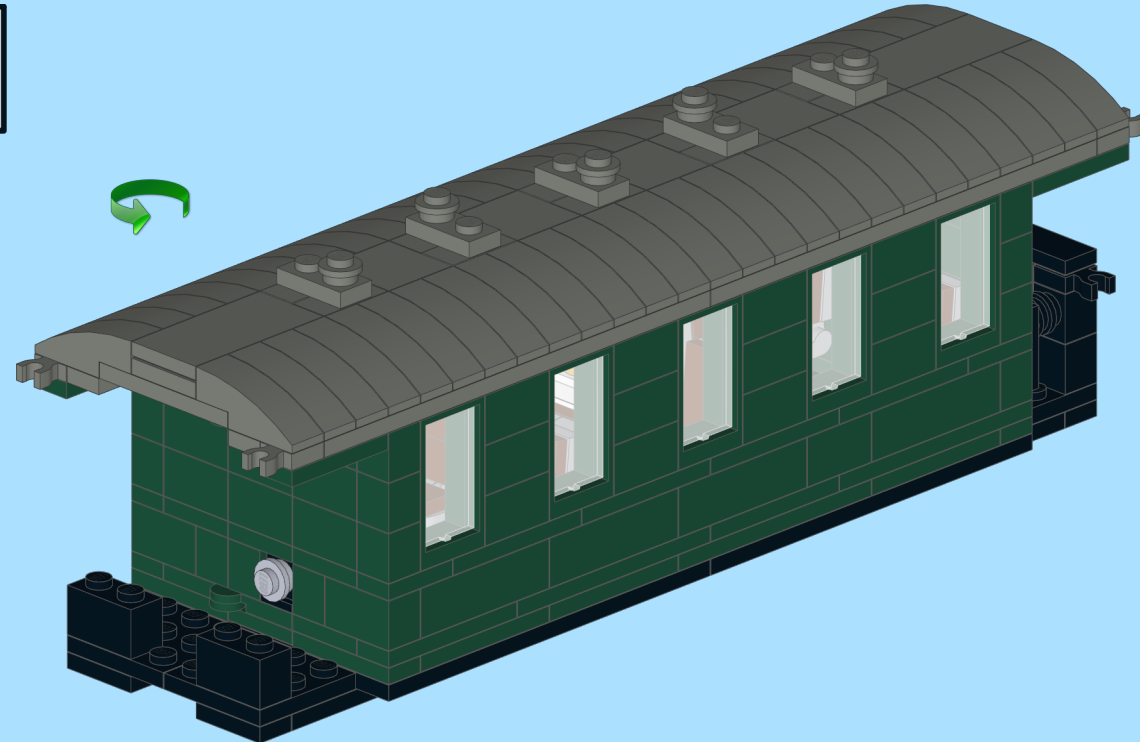
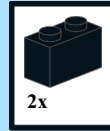

22









23

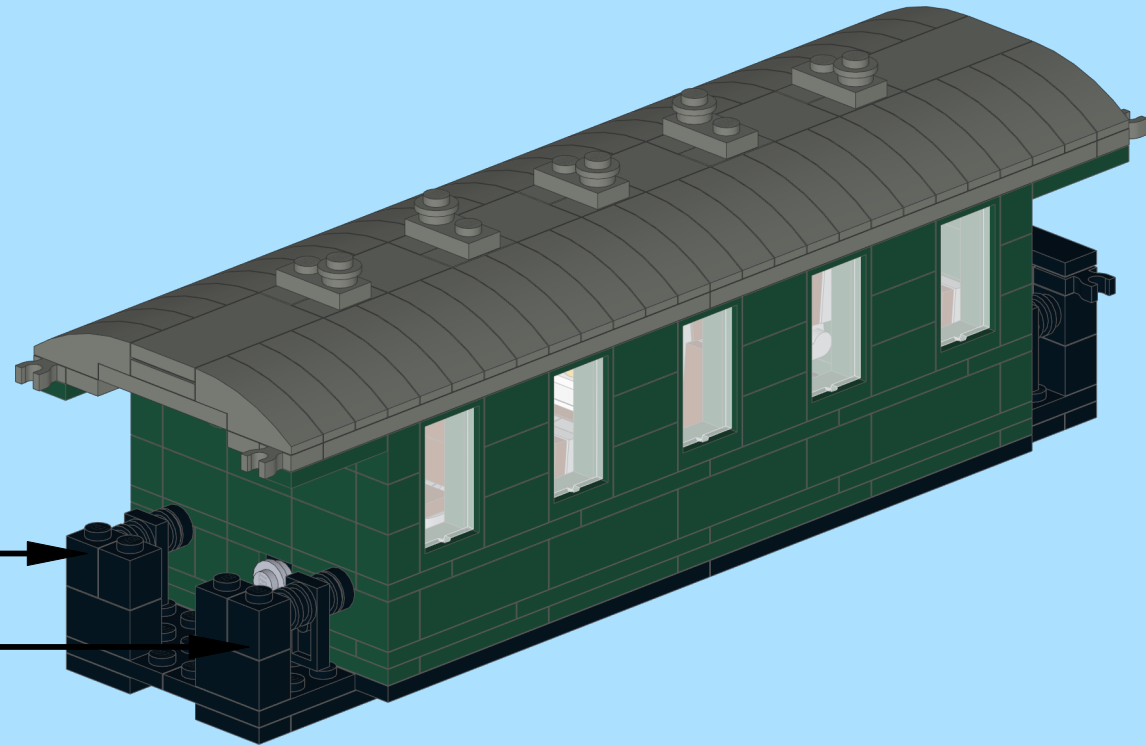



- 24
-  2x
  -  6x
  -  2x
  -  2x
  -  2x

- 1 
- 2 
- x2



- 25
-  2x
  -  2x
  -  2x
  -  1x
  -  1x

- 1 
- 2 

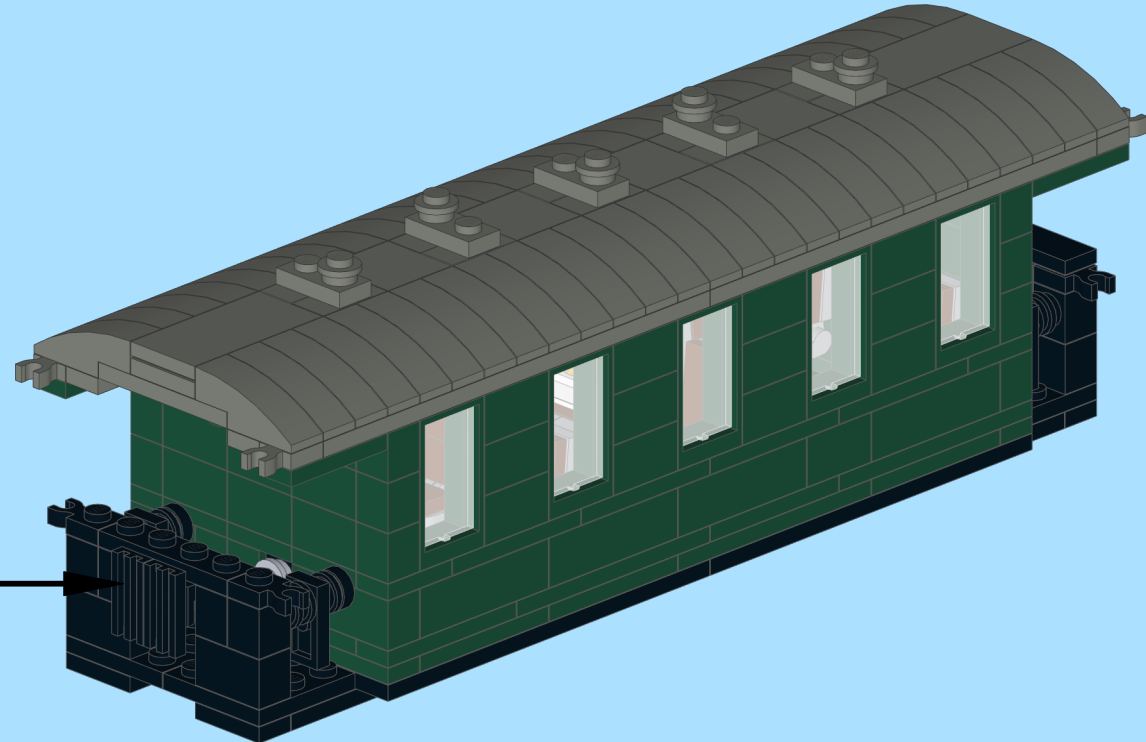

26

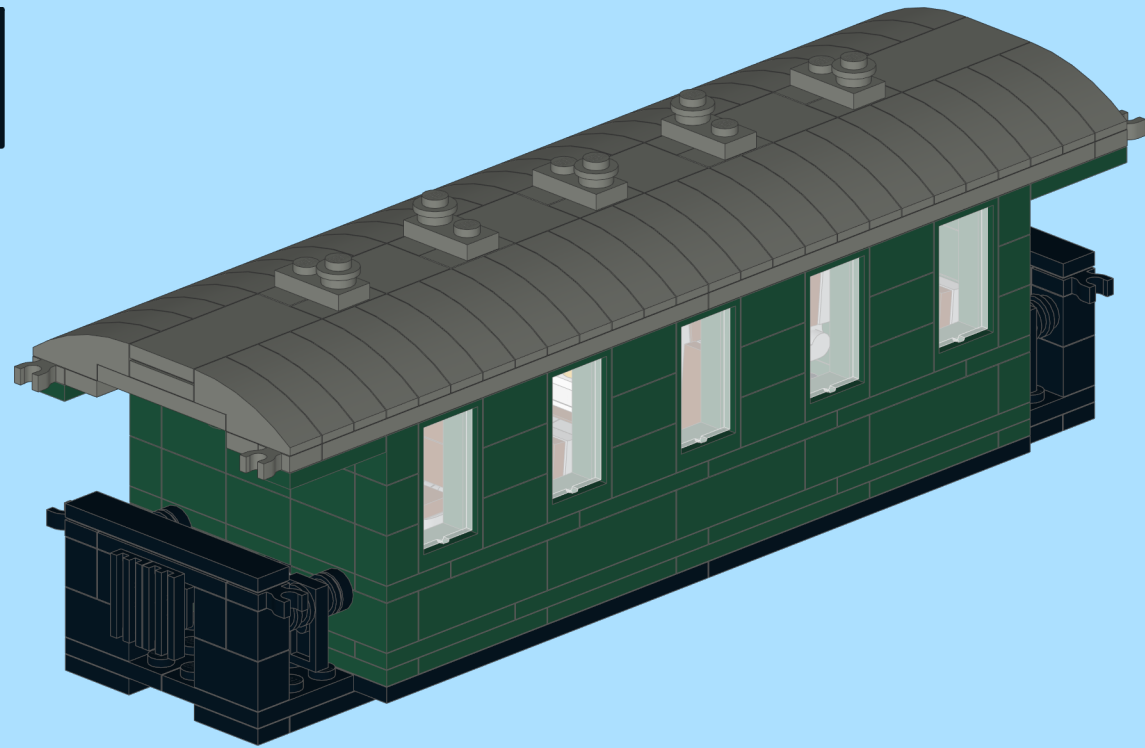
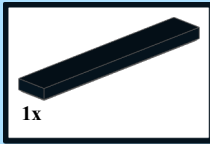

27

