

Pacific Passenger Car

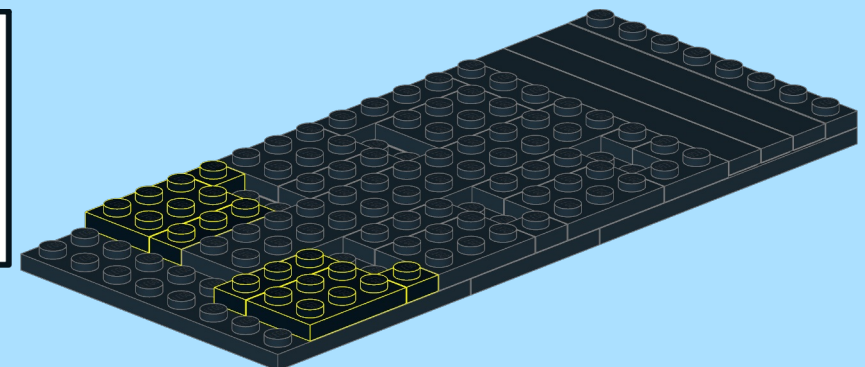

DESIGNED BY
KNUD ALBRECHTSEN
www.snakebyte.dk/lego

INSTRUCTION BY
KNUD ALBRECHTSEN
www.snakebyte.dk/lego

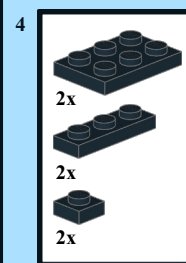
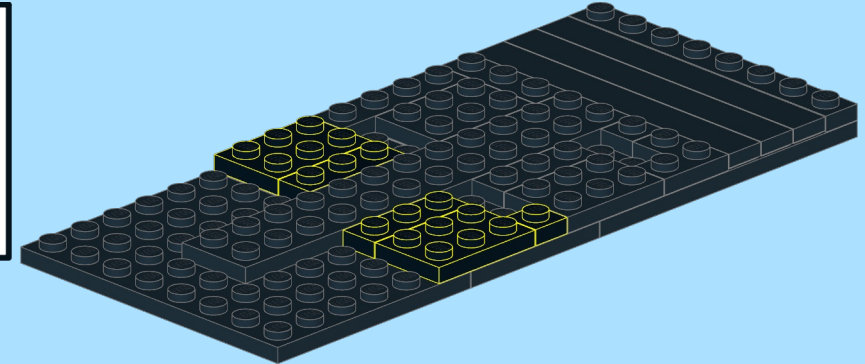
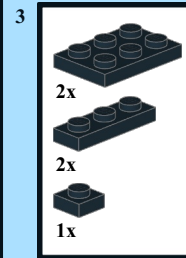
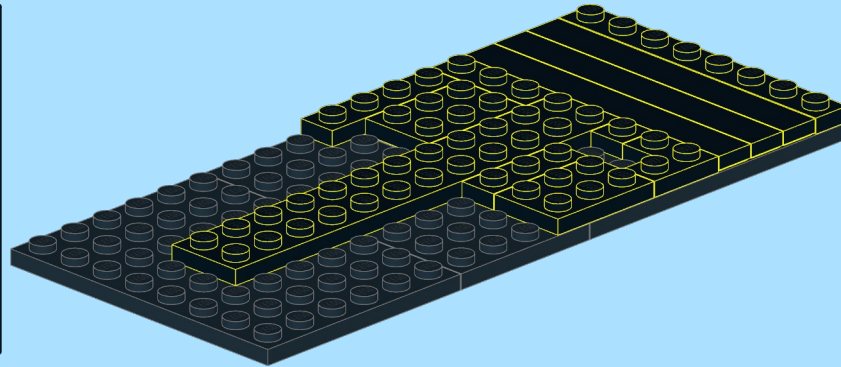
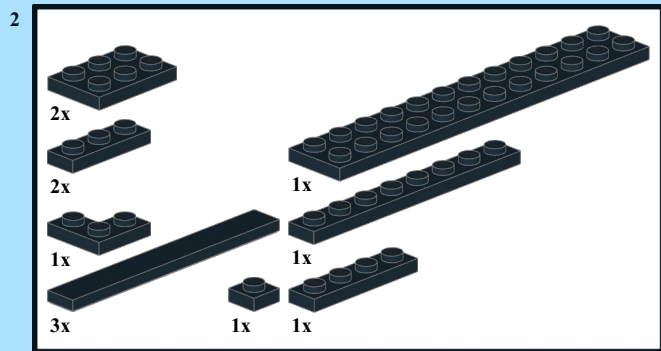
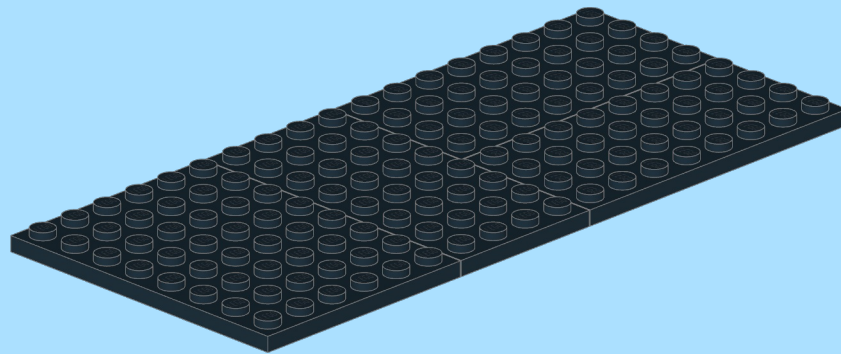
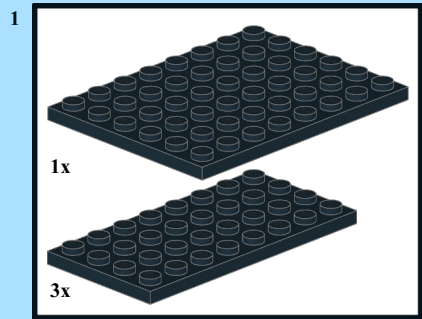

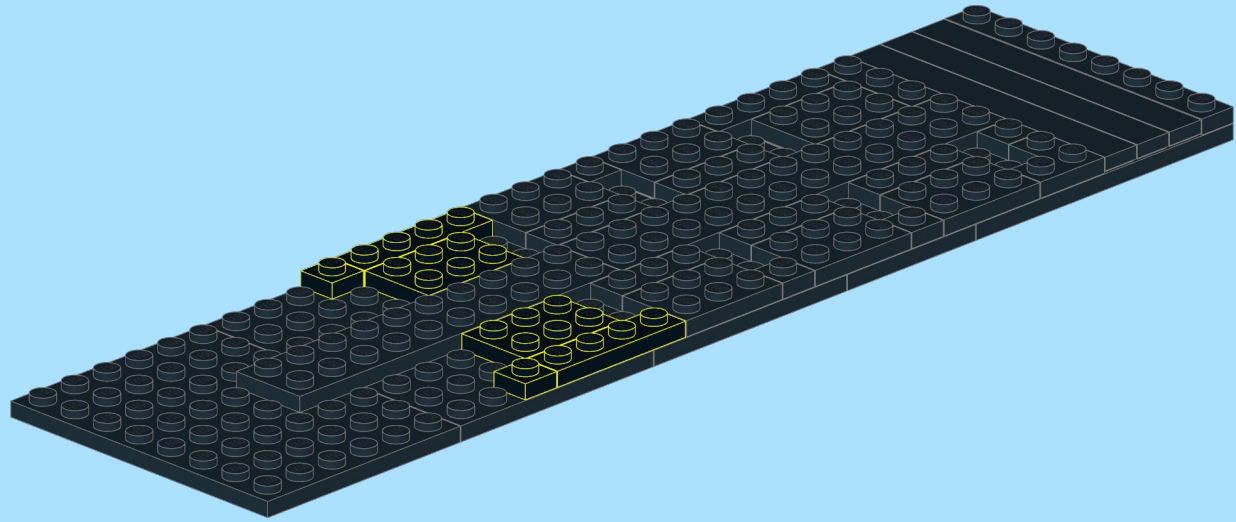
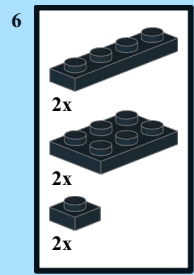
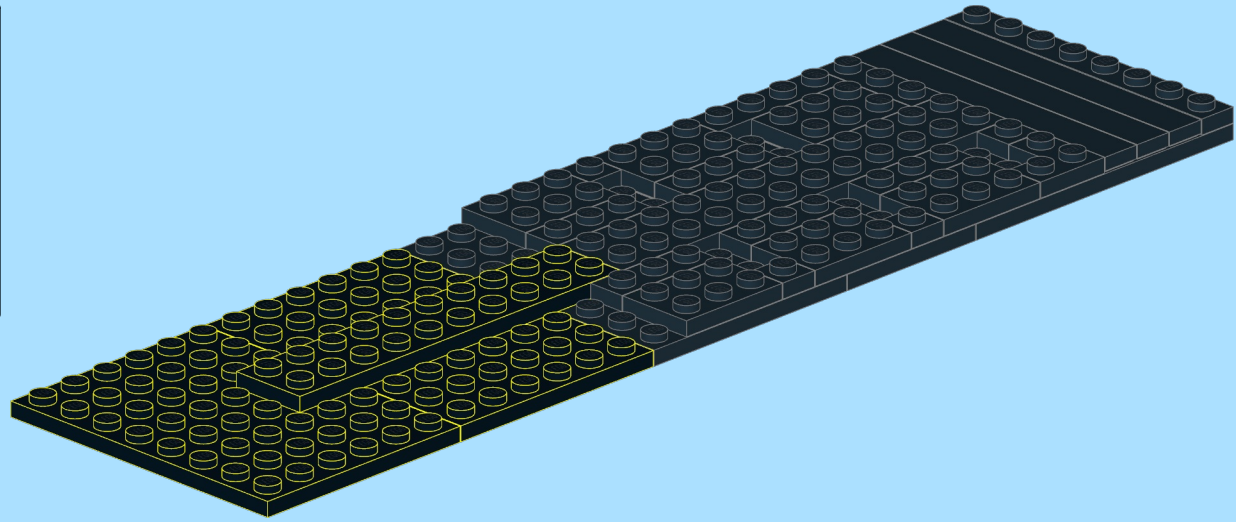
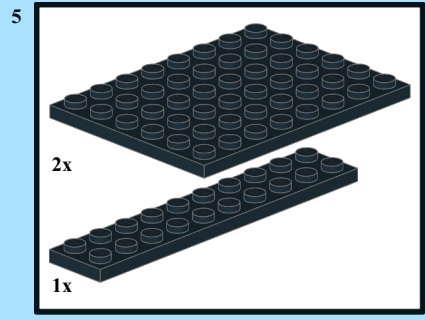

7

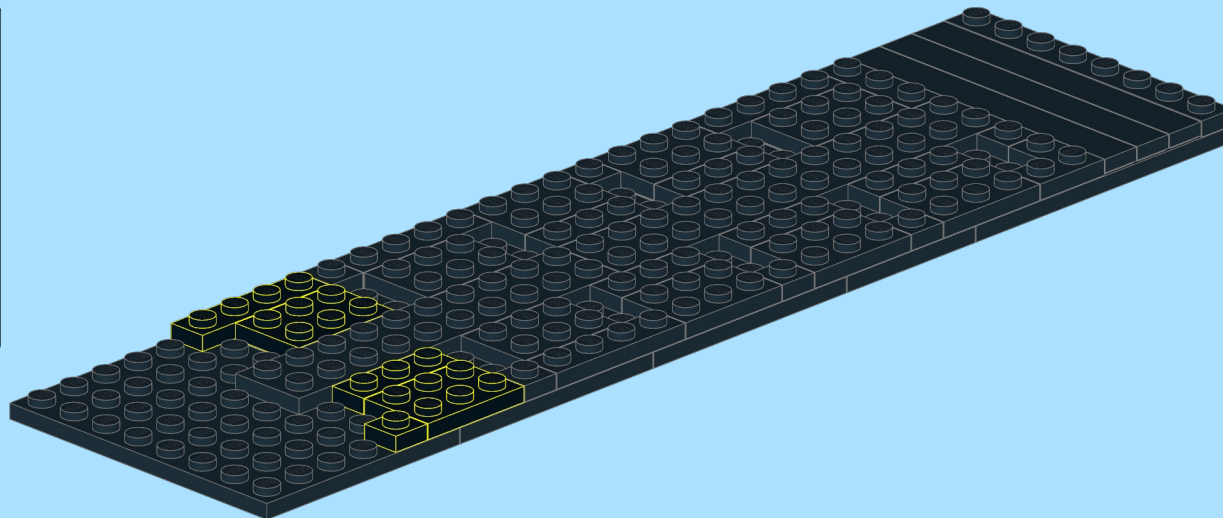
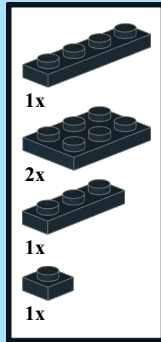

8

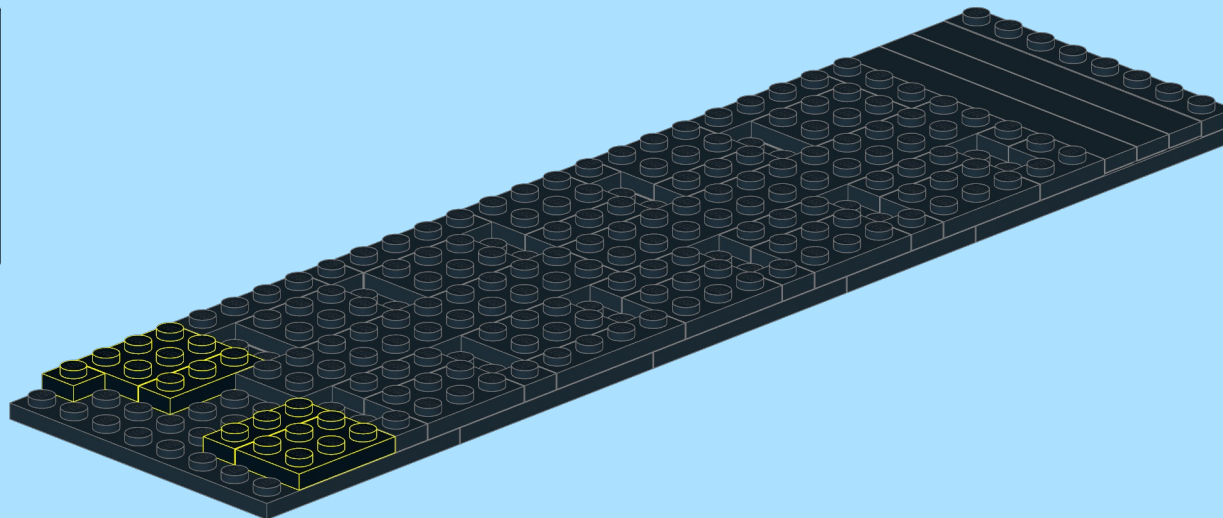
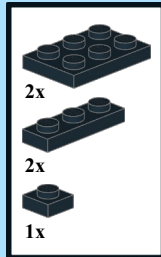

9

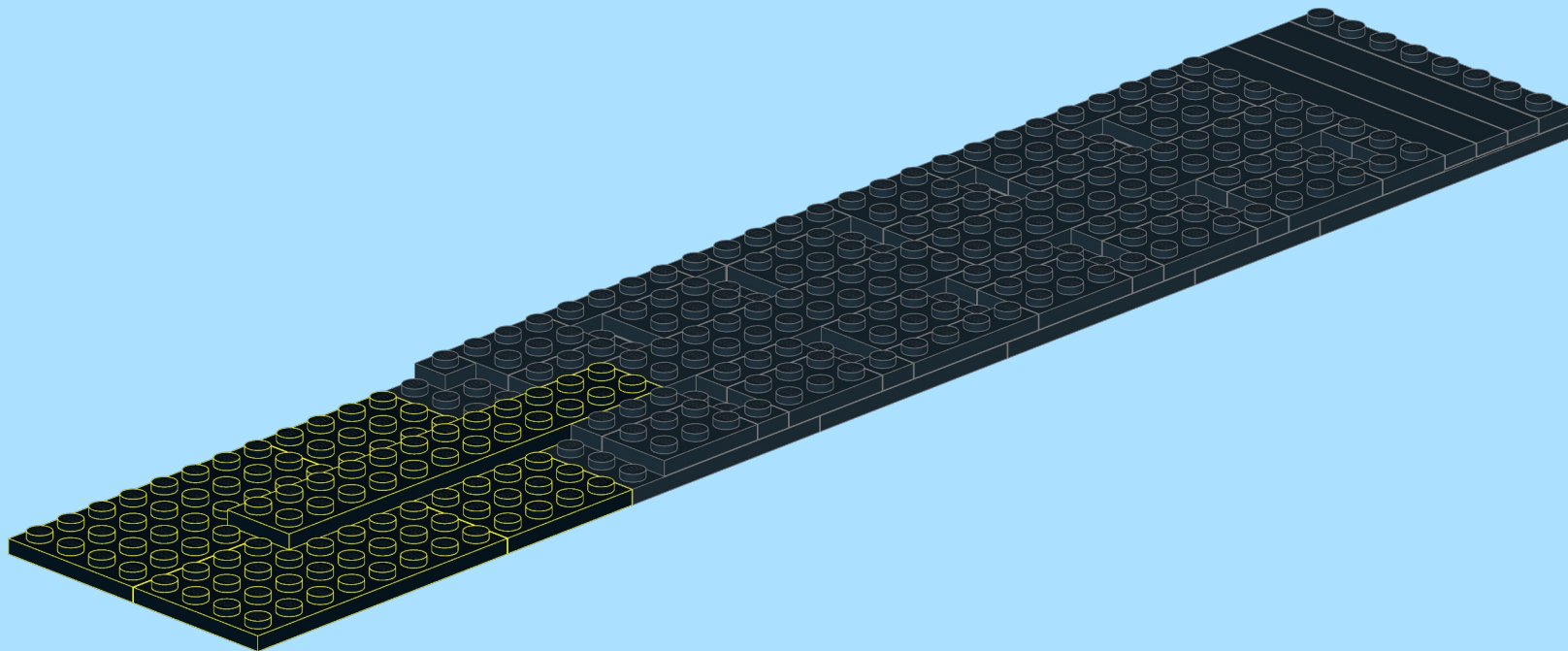
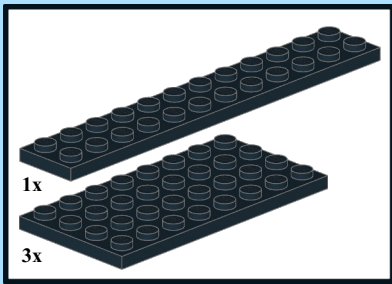

10

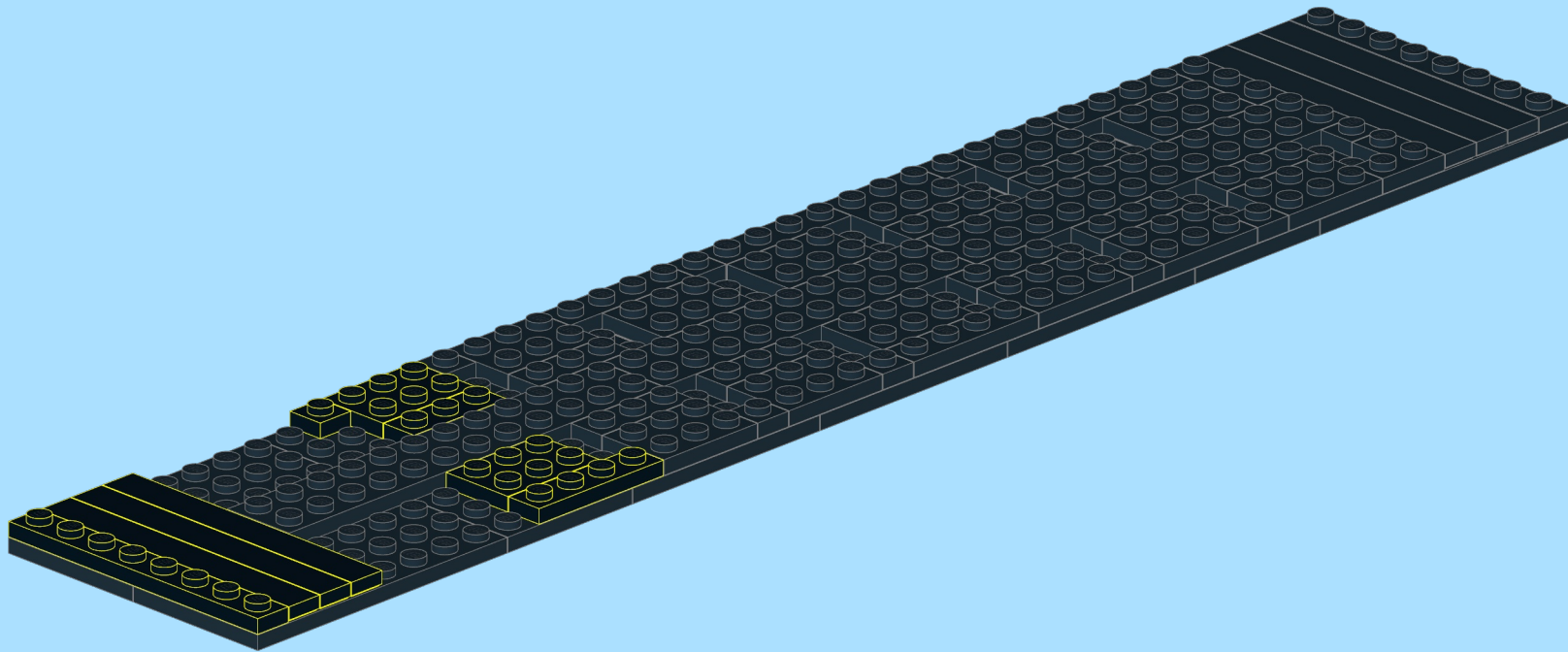
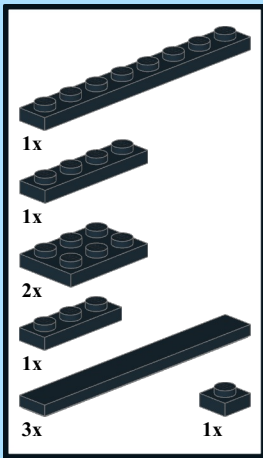

11

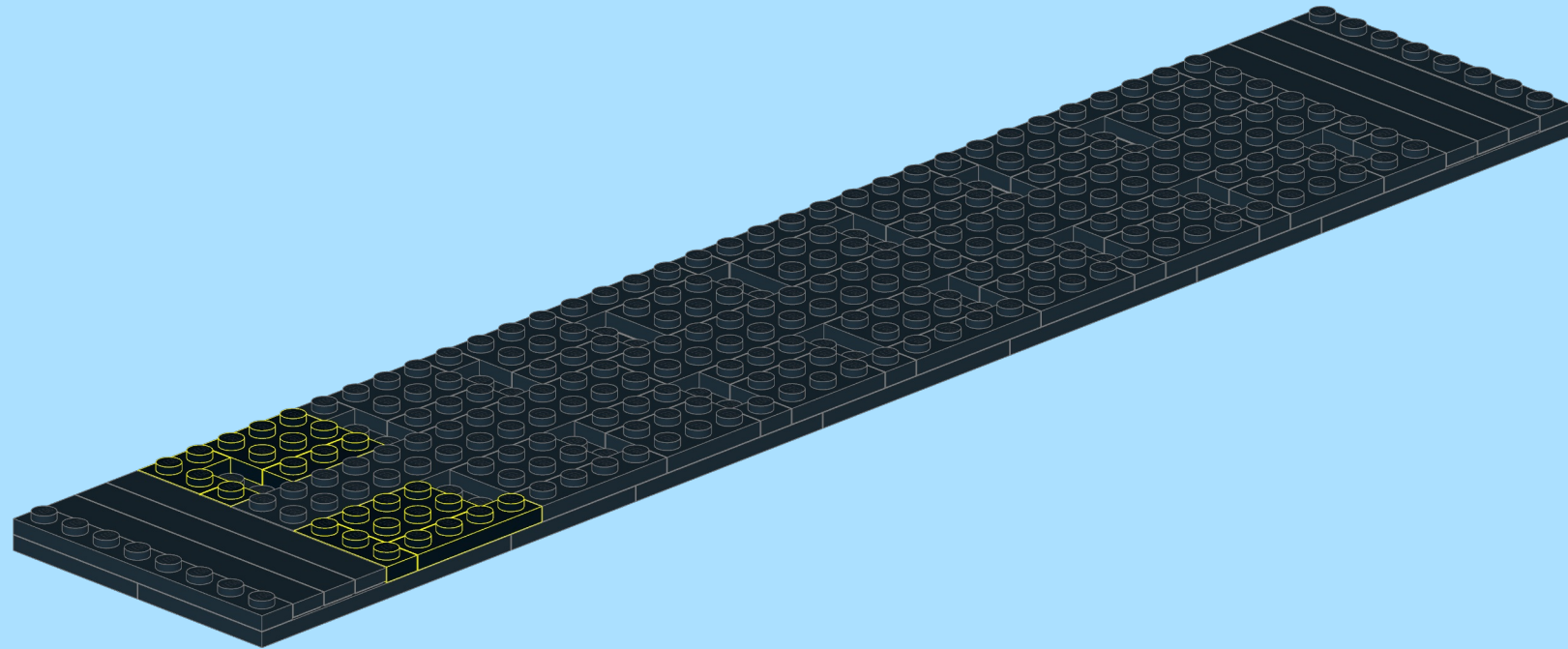
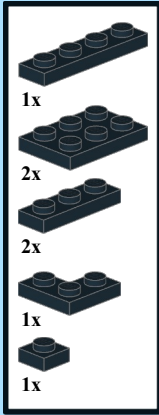

12

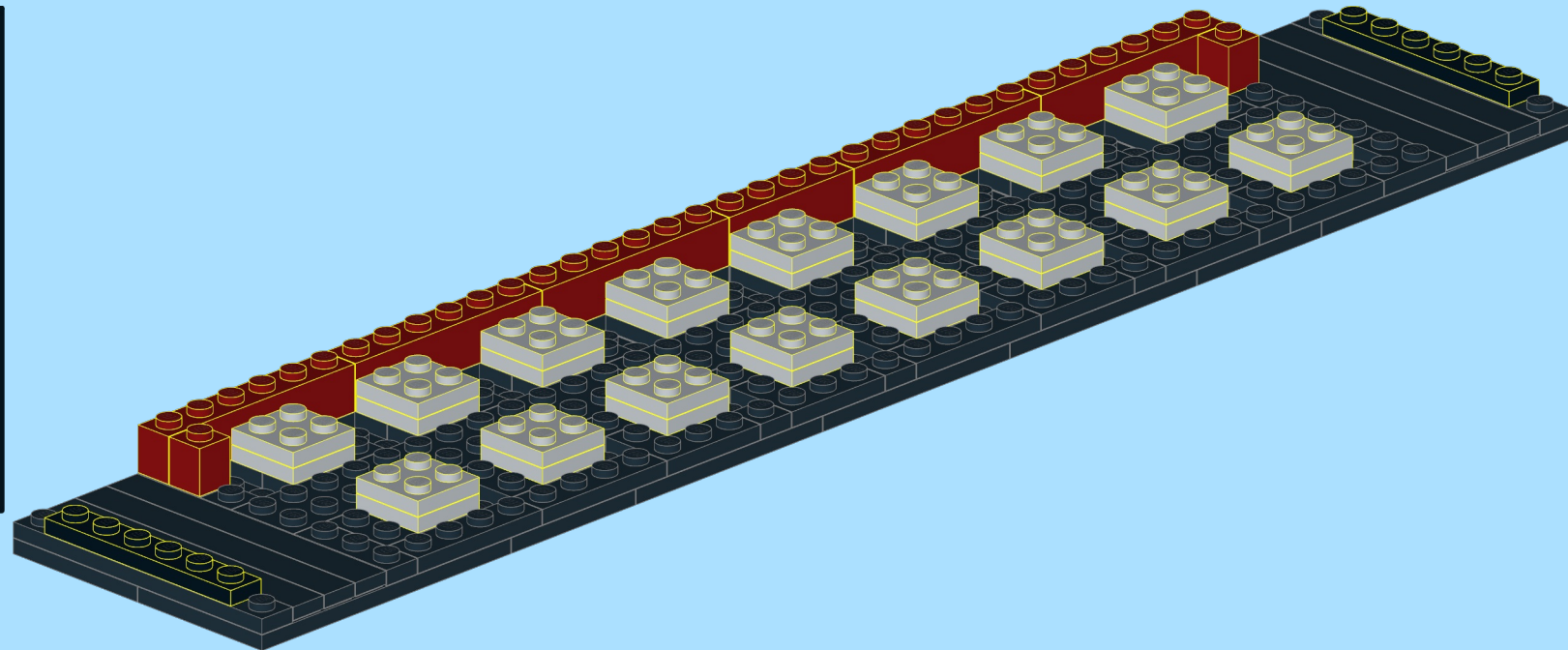
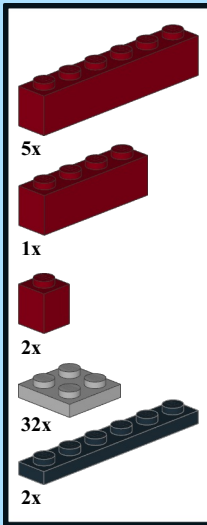

13

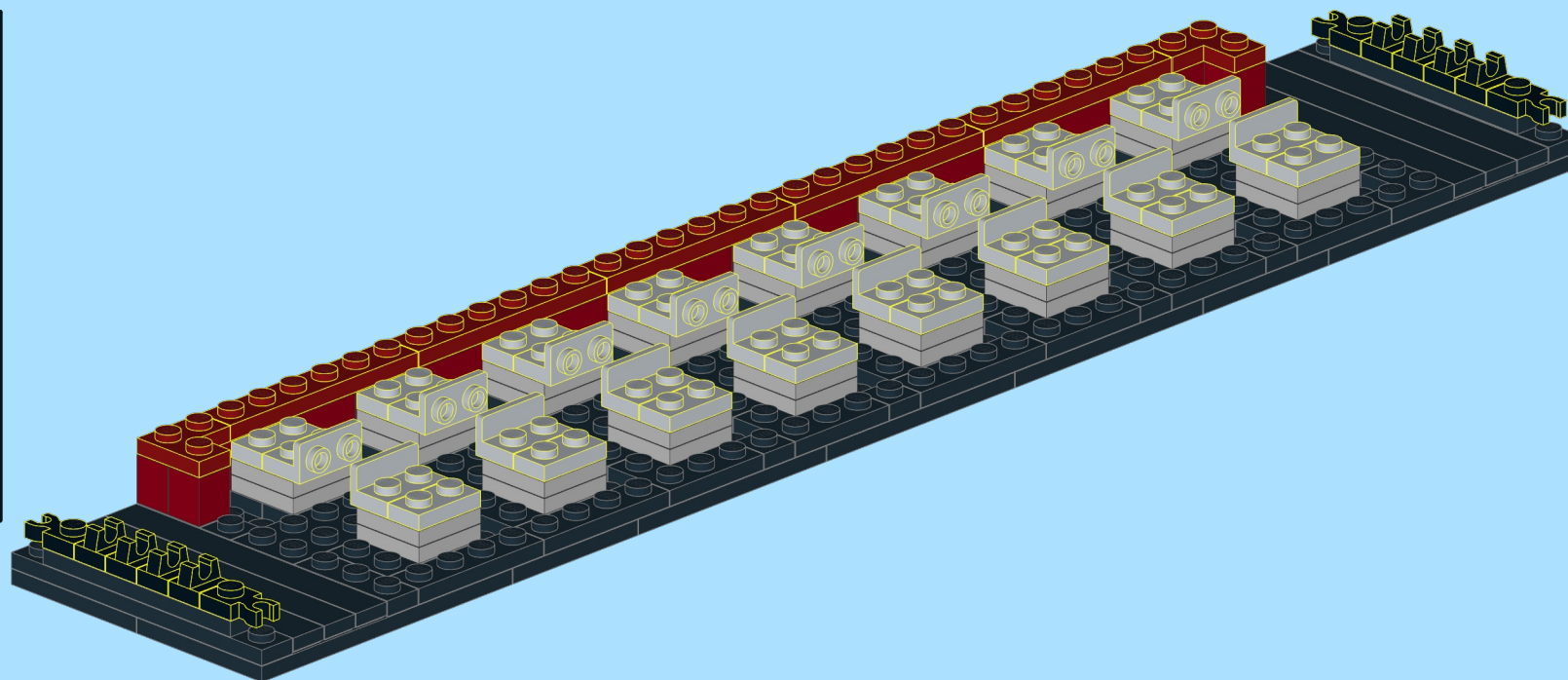
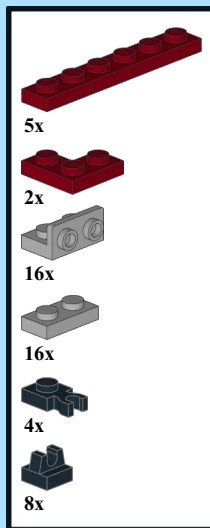

14

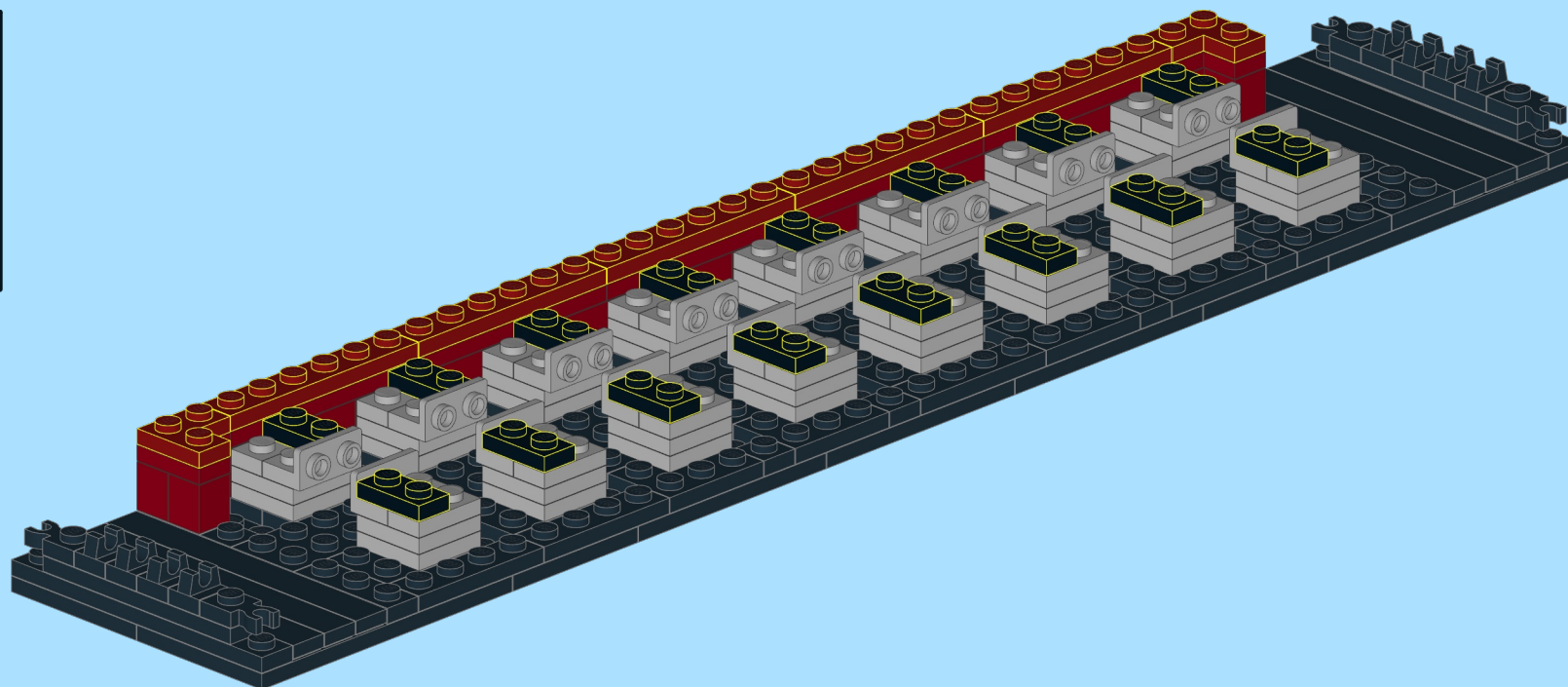
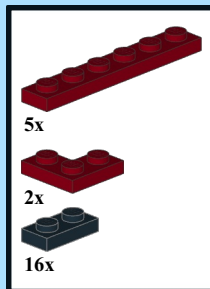

15

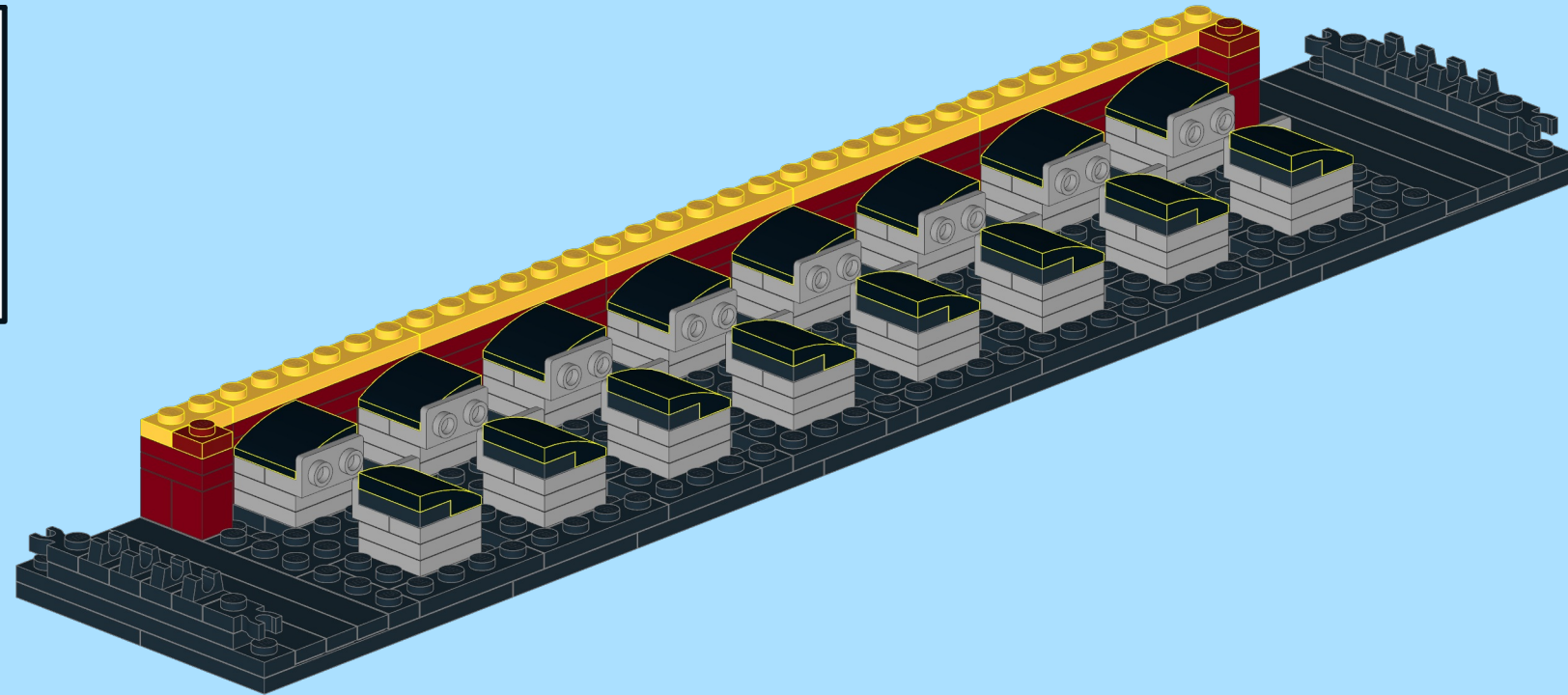
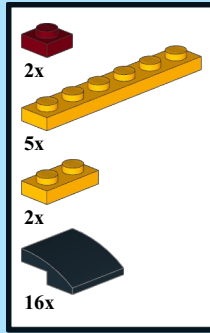

16

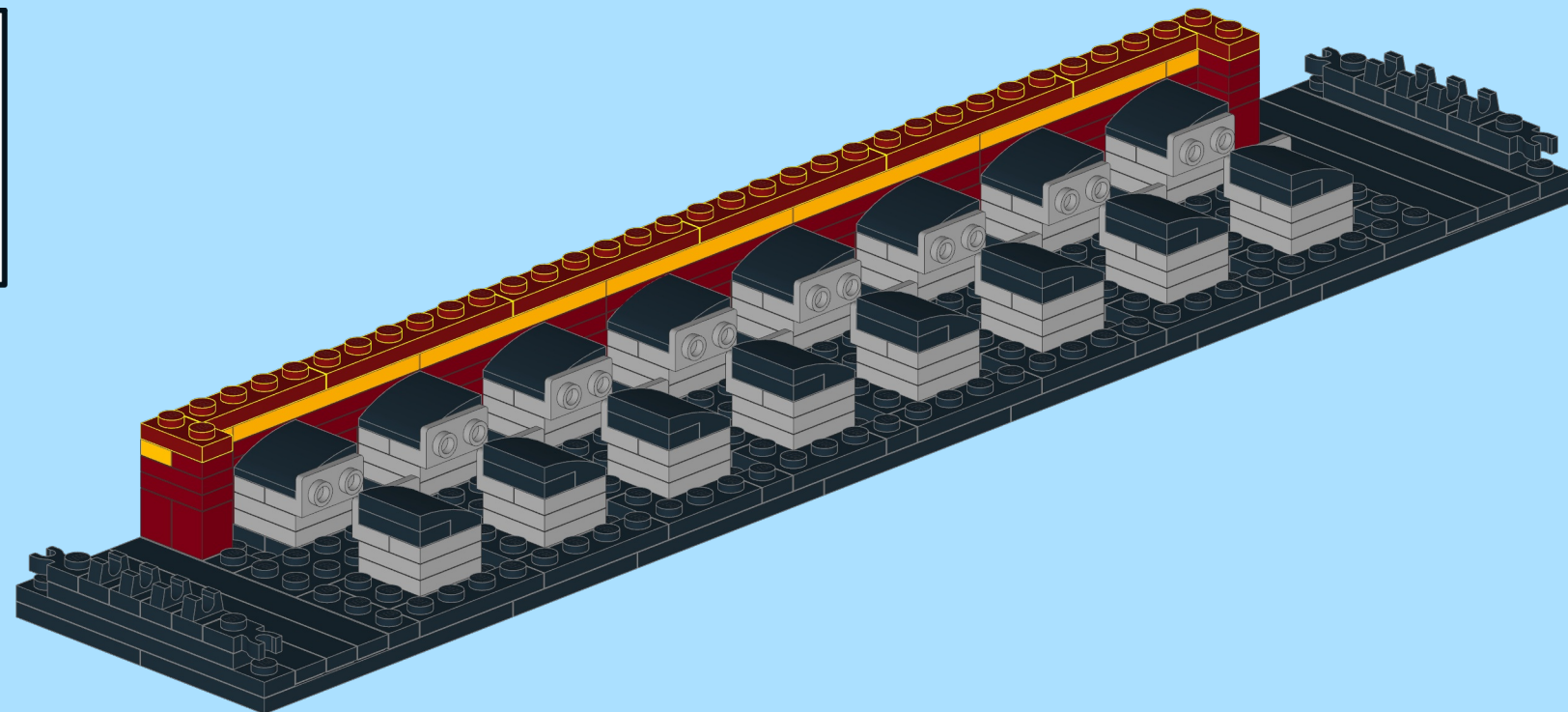
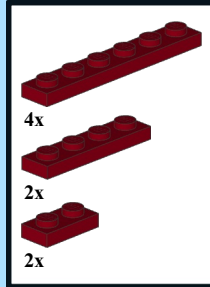

17

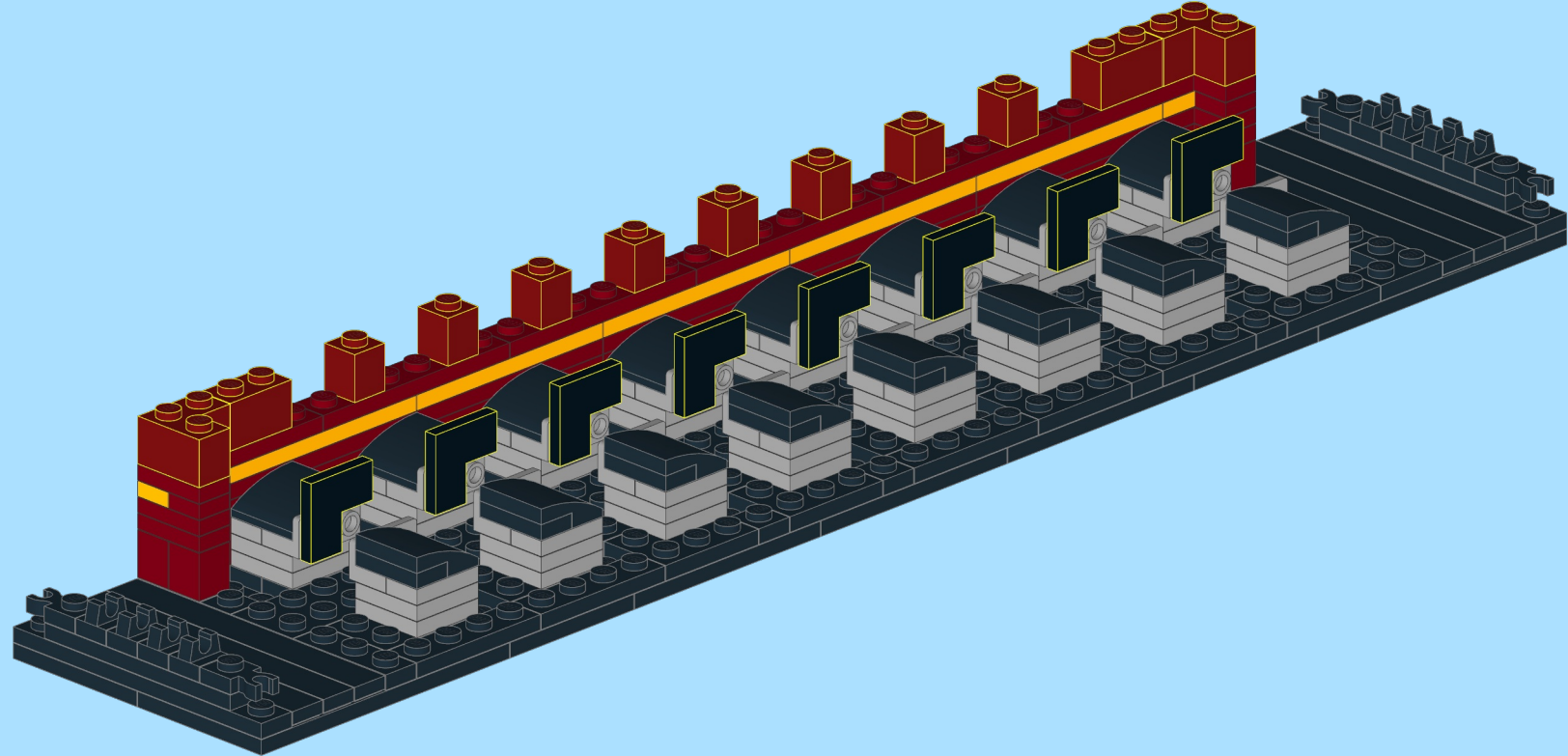
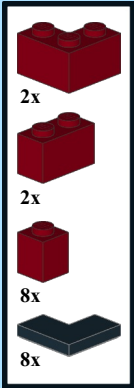

18

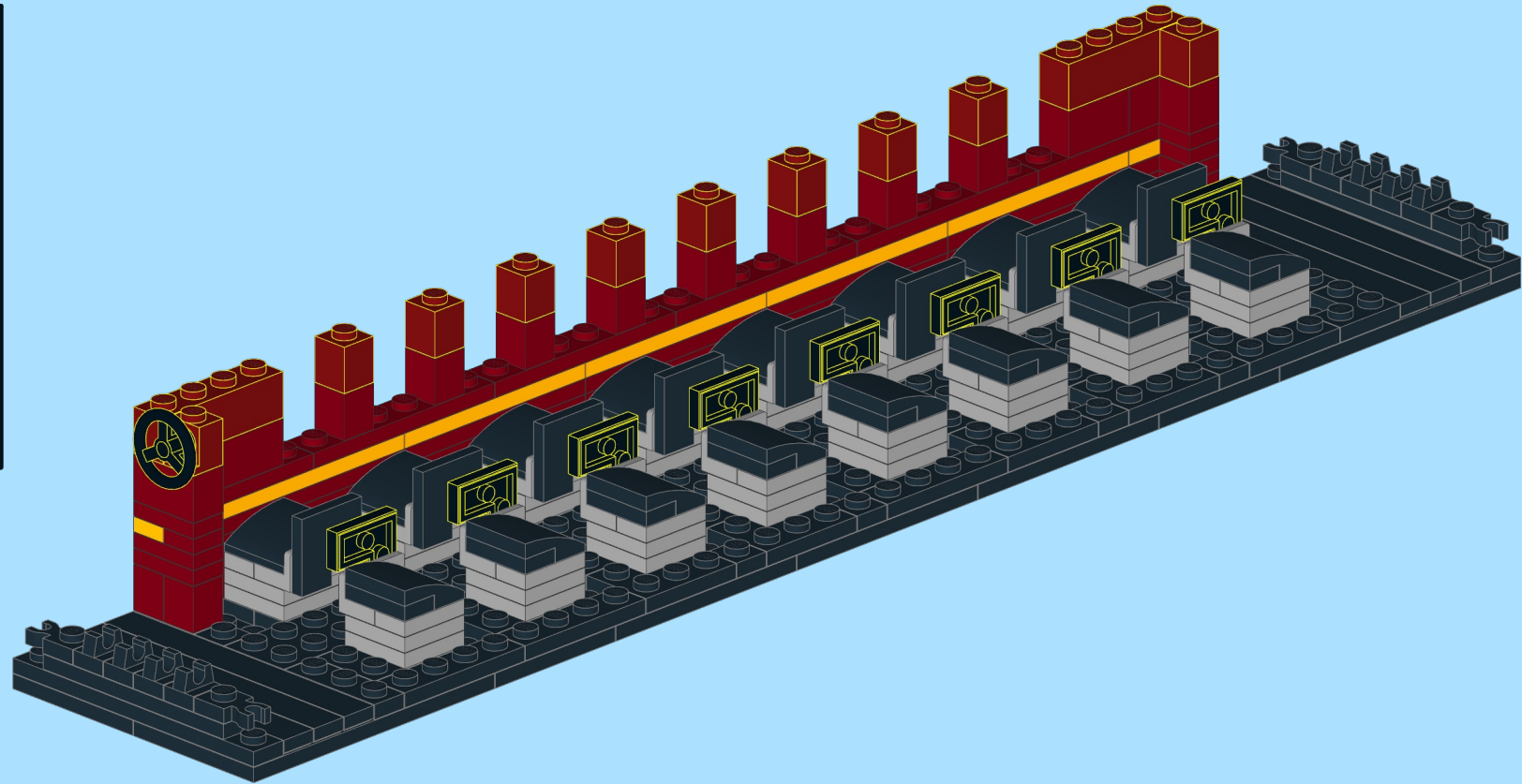
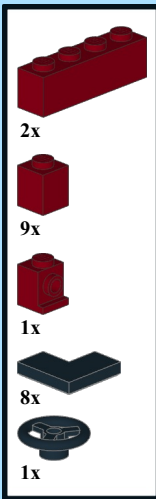

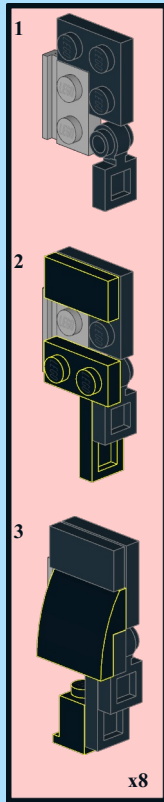
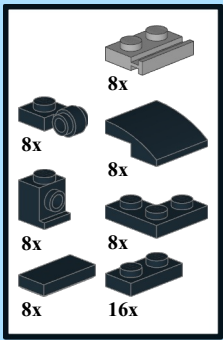

x8

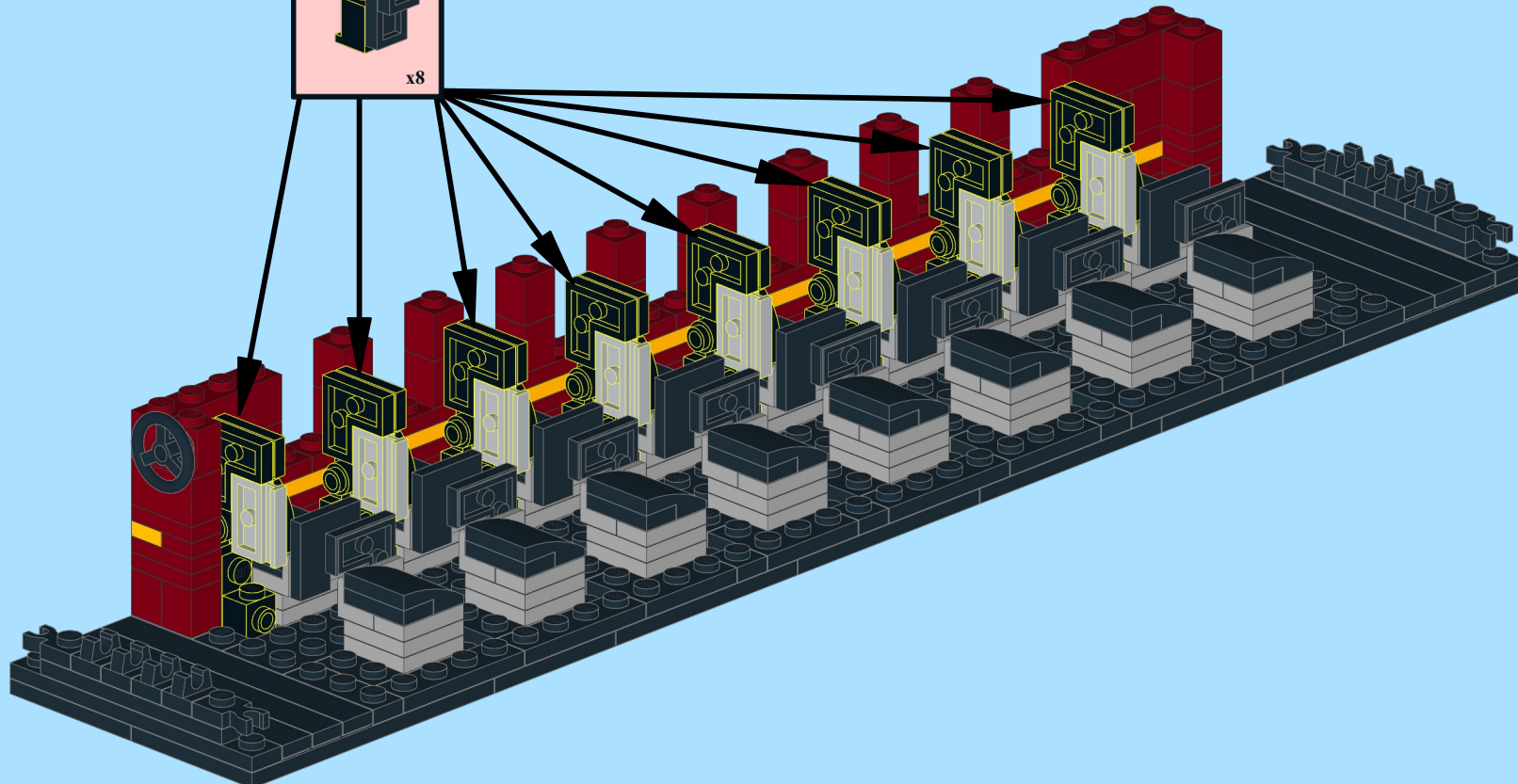

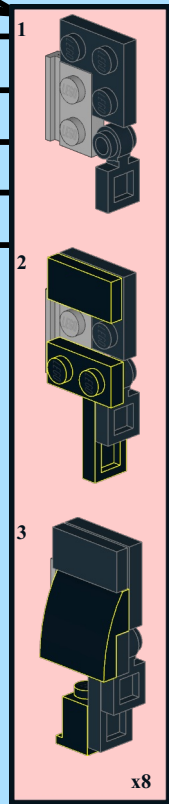
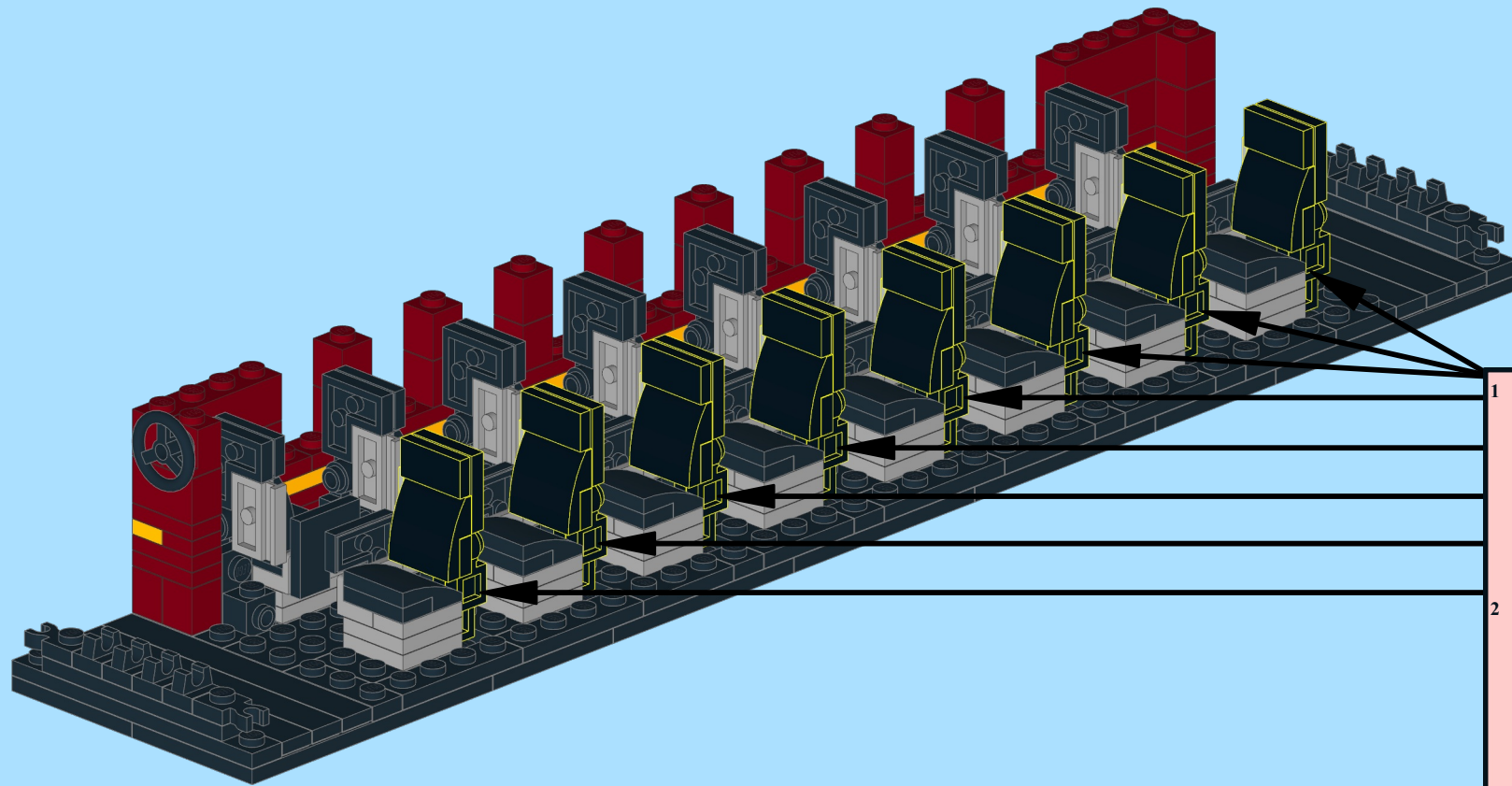
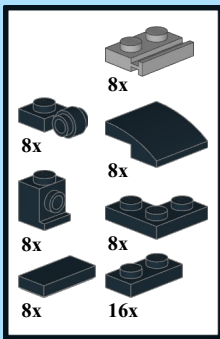

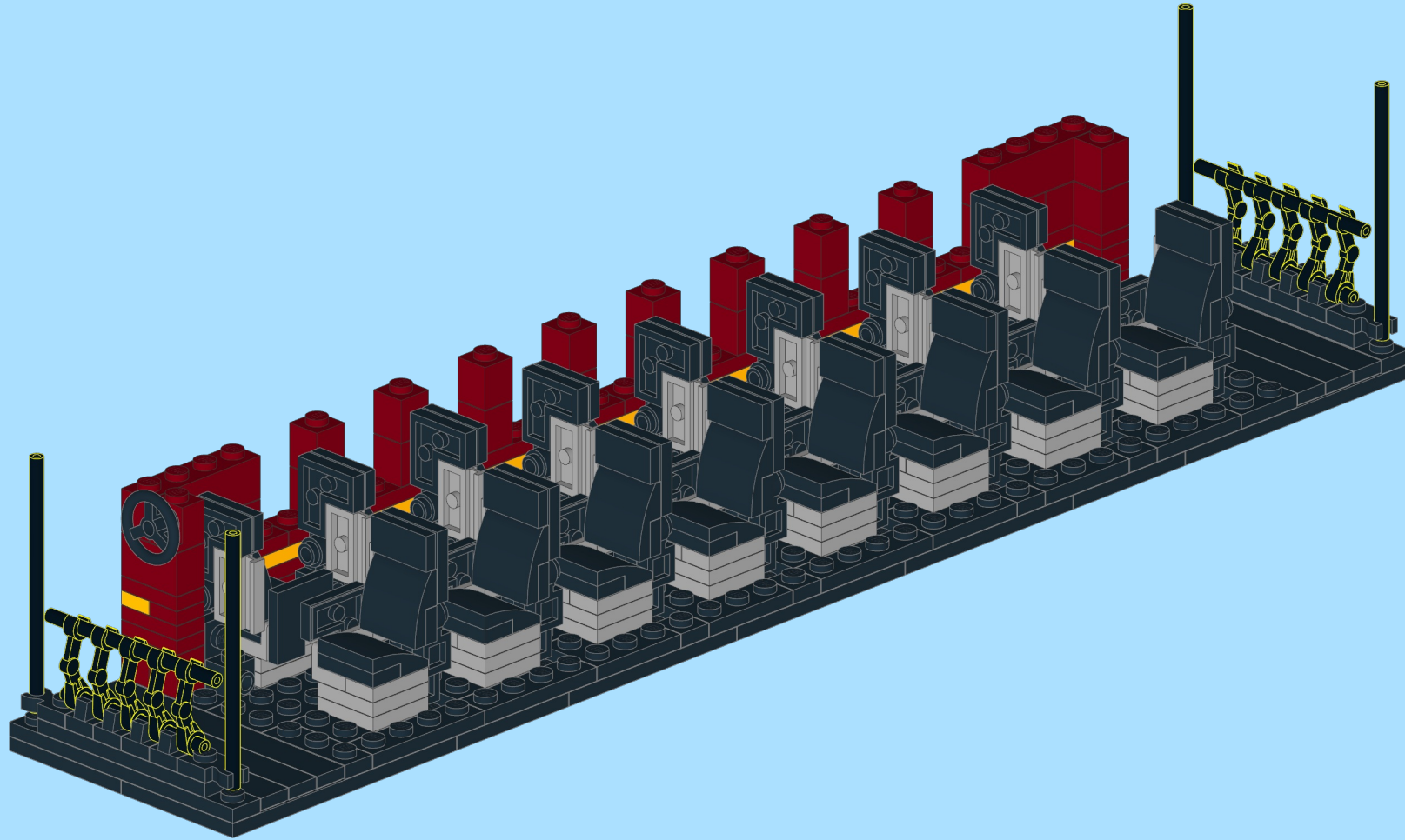
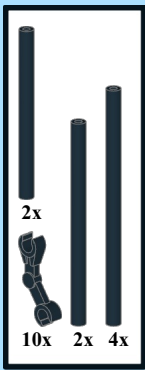

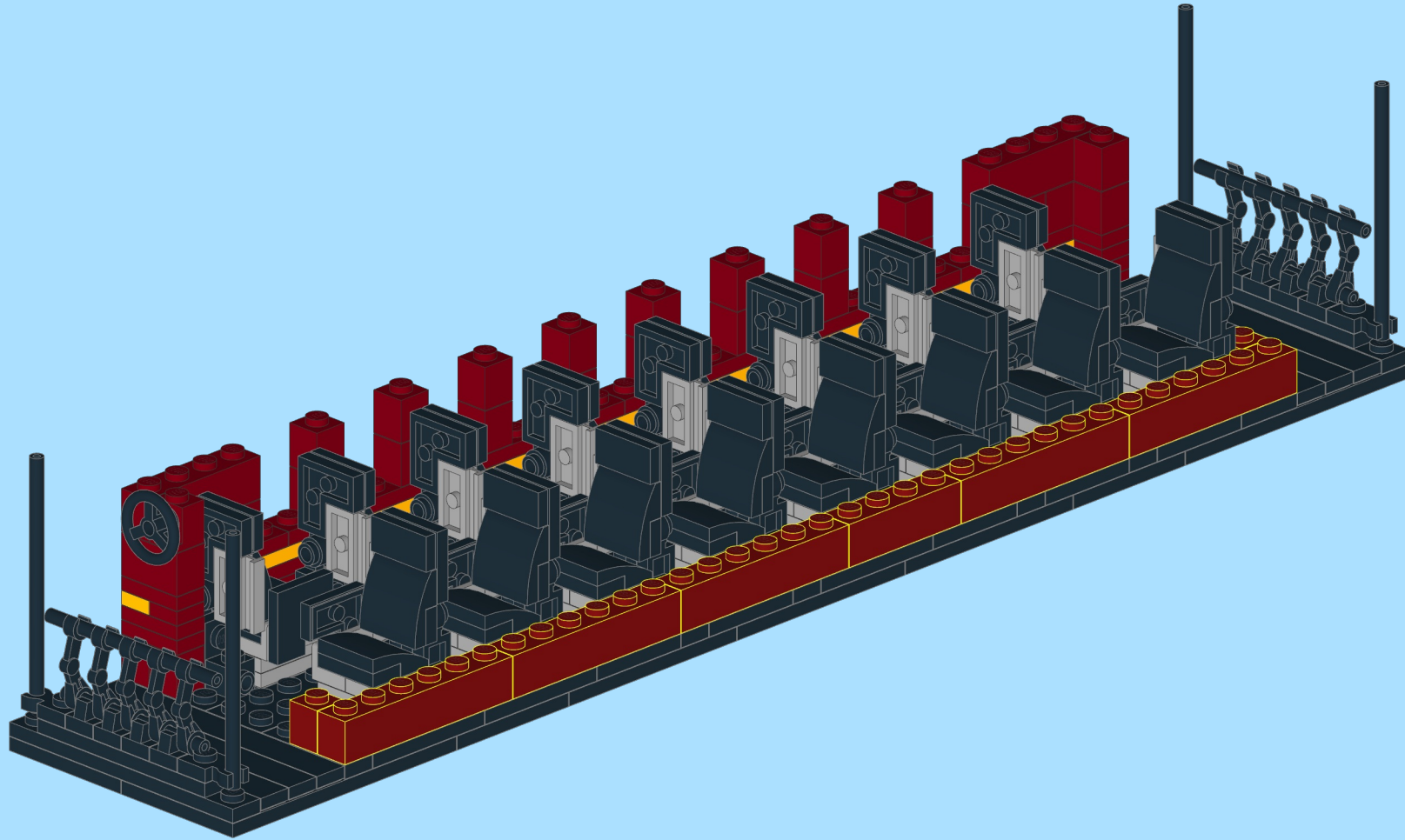
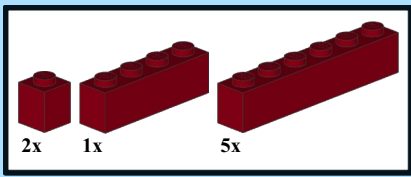

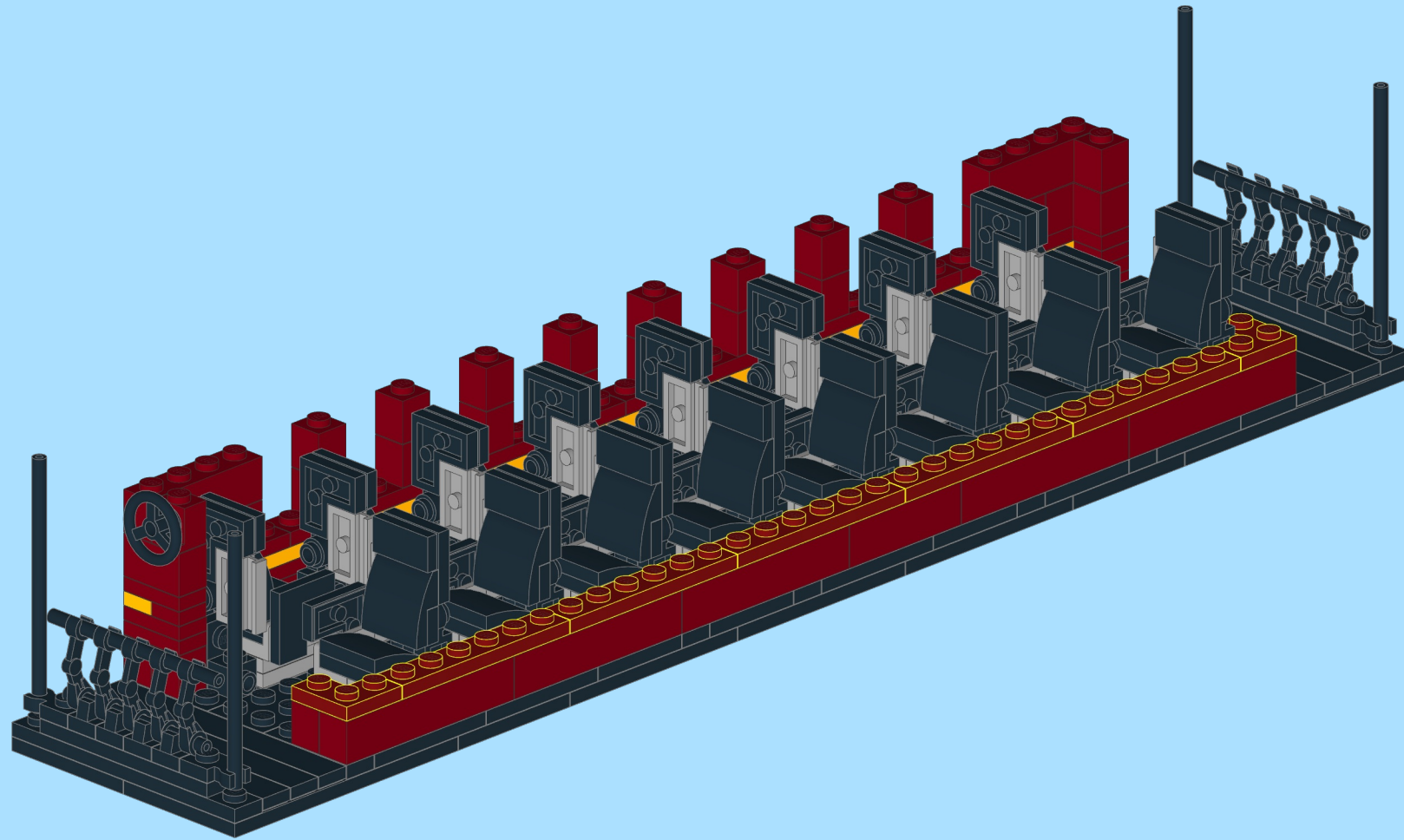
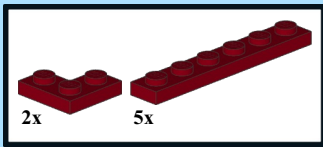

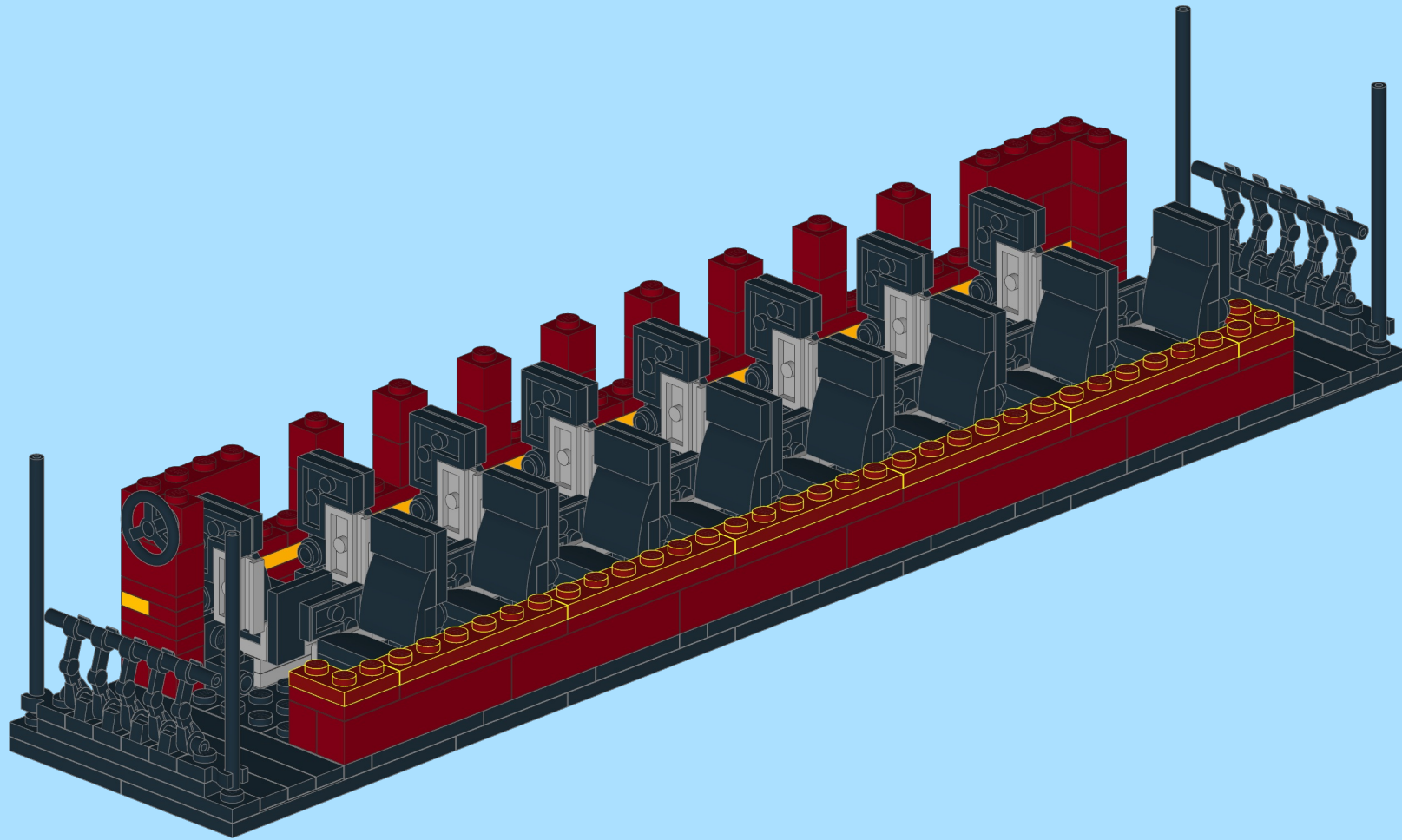
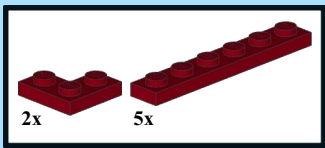

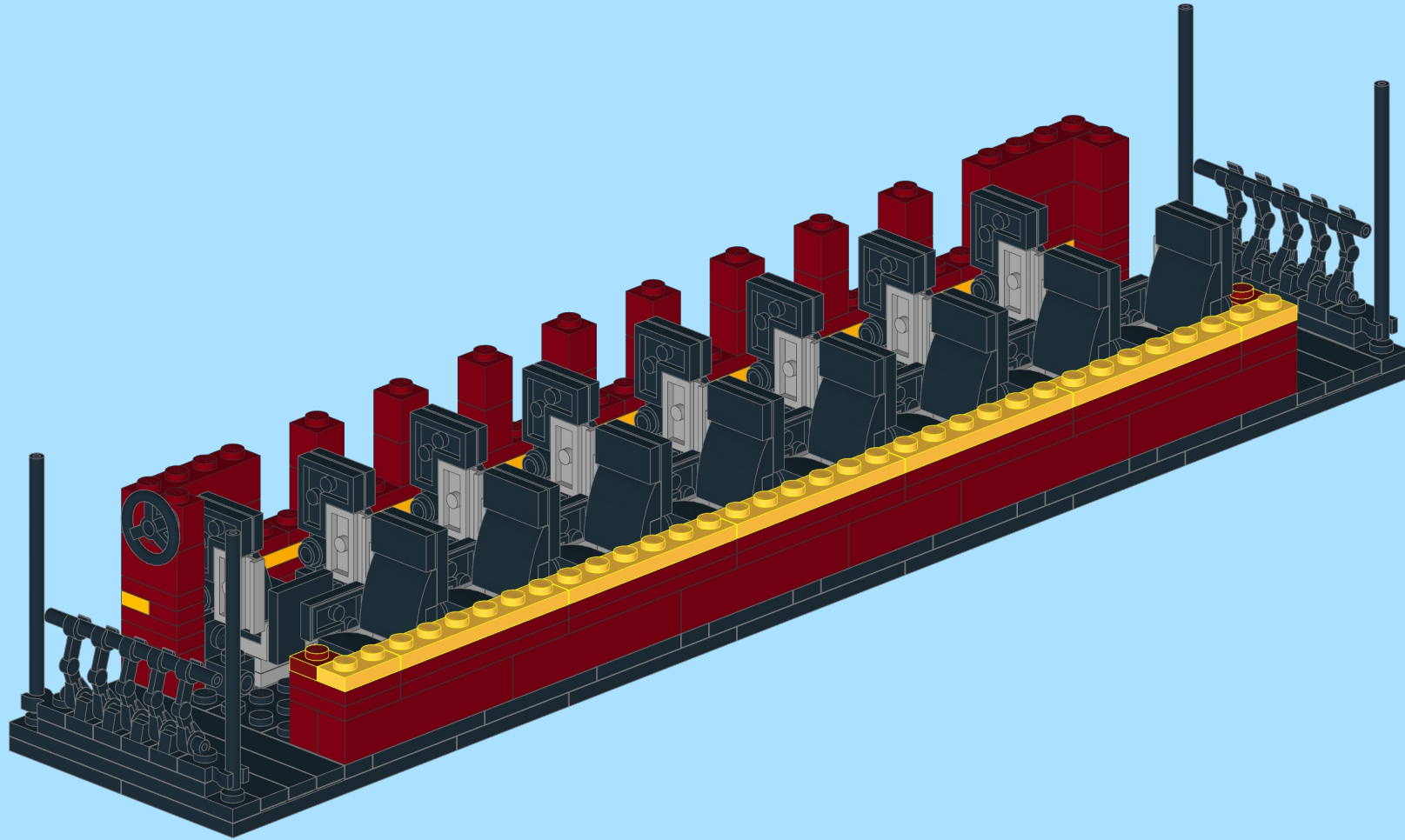
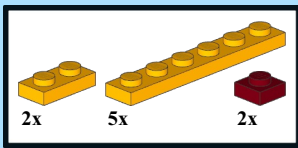

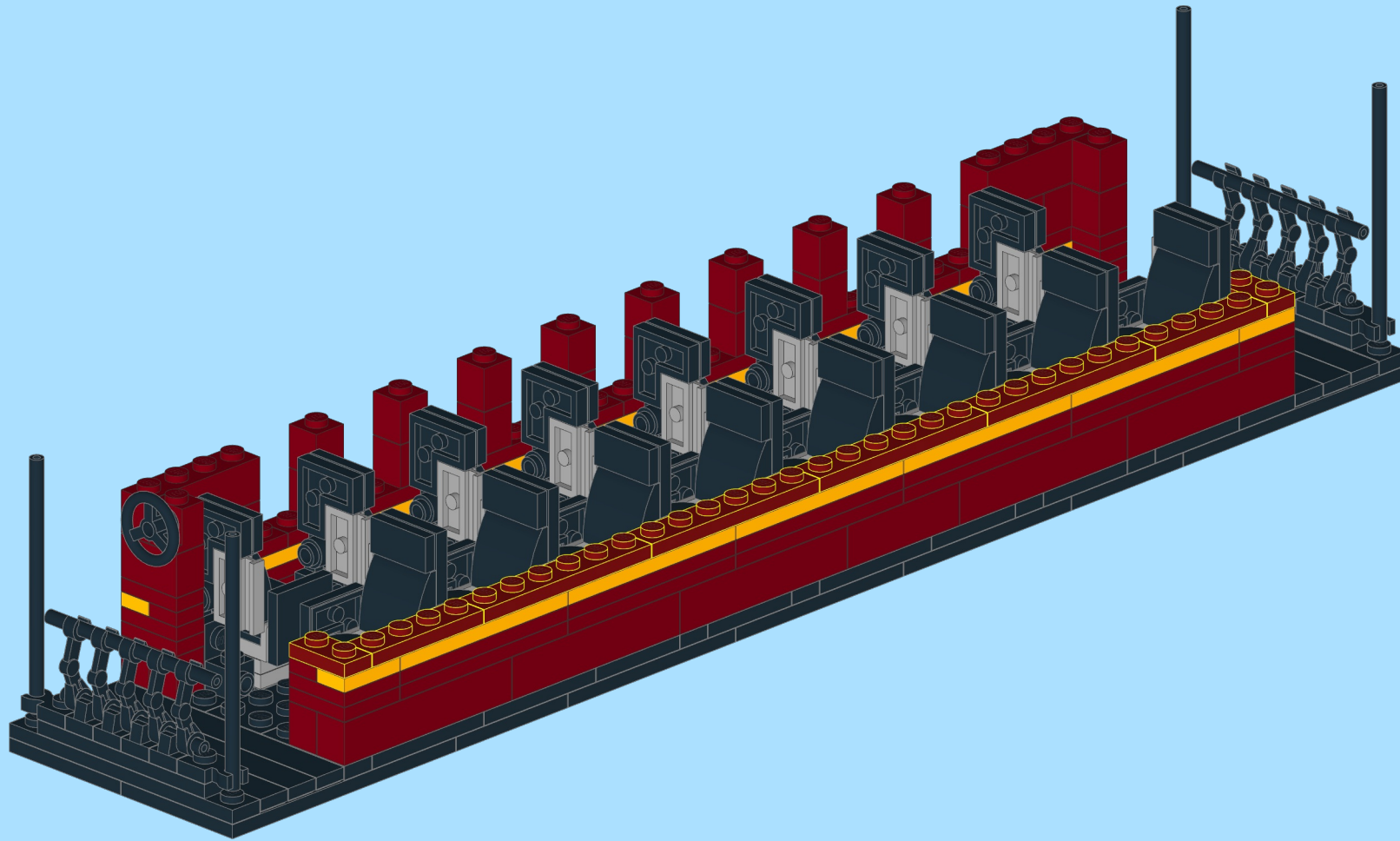
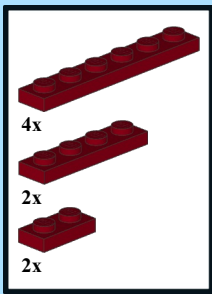

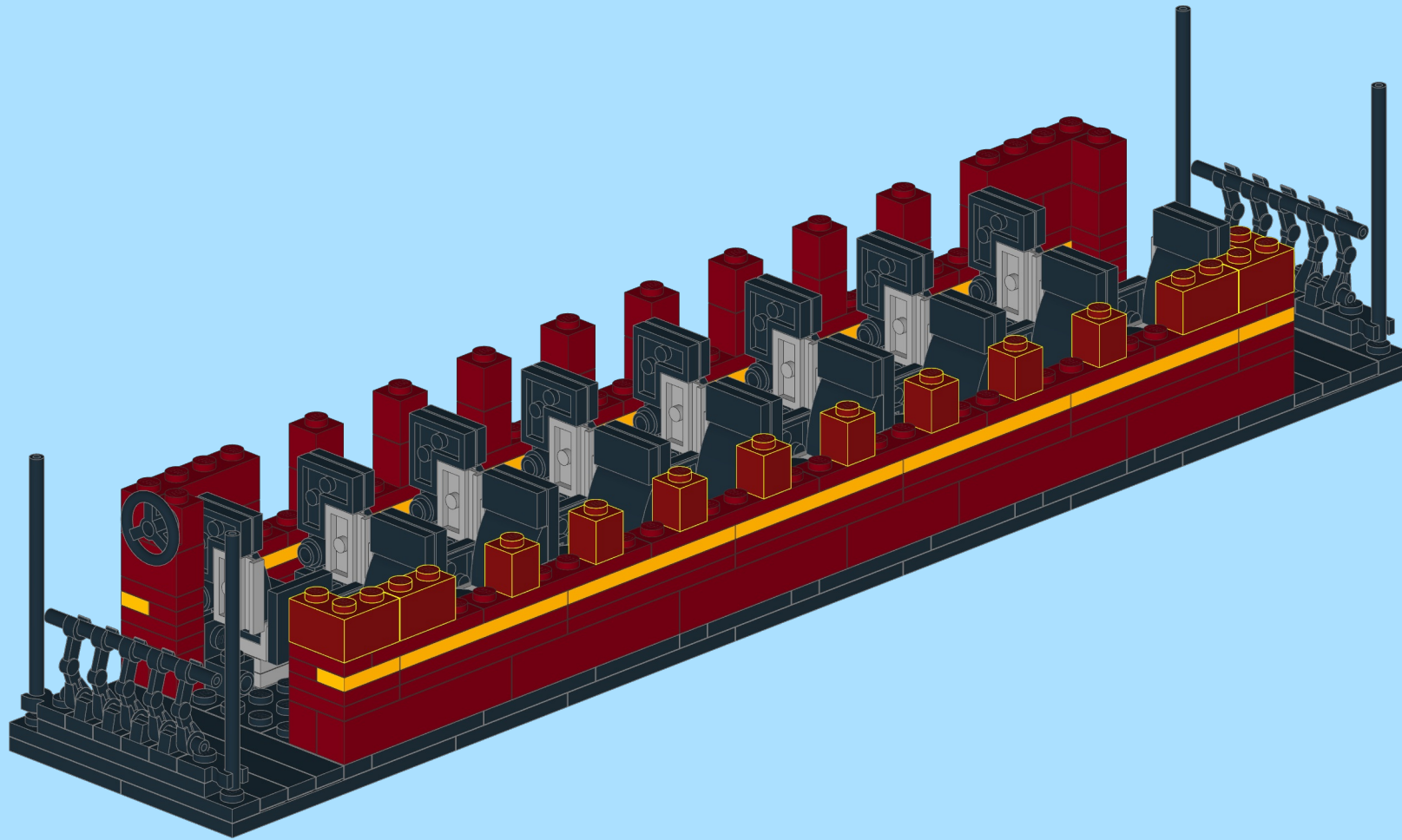
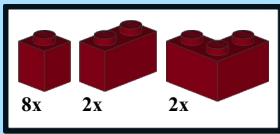

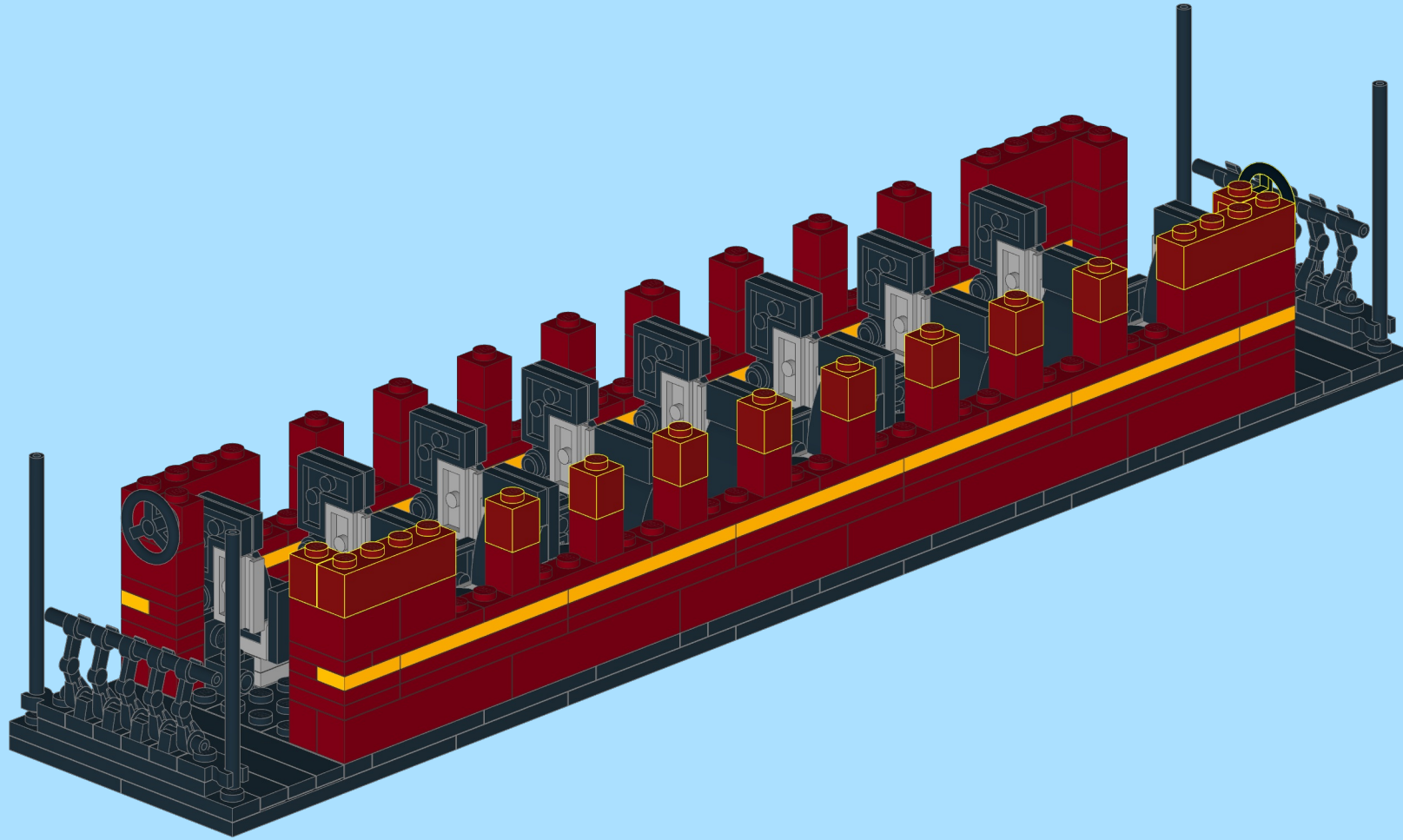
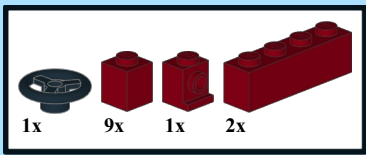

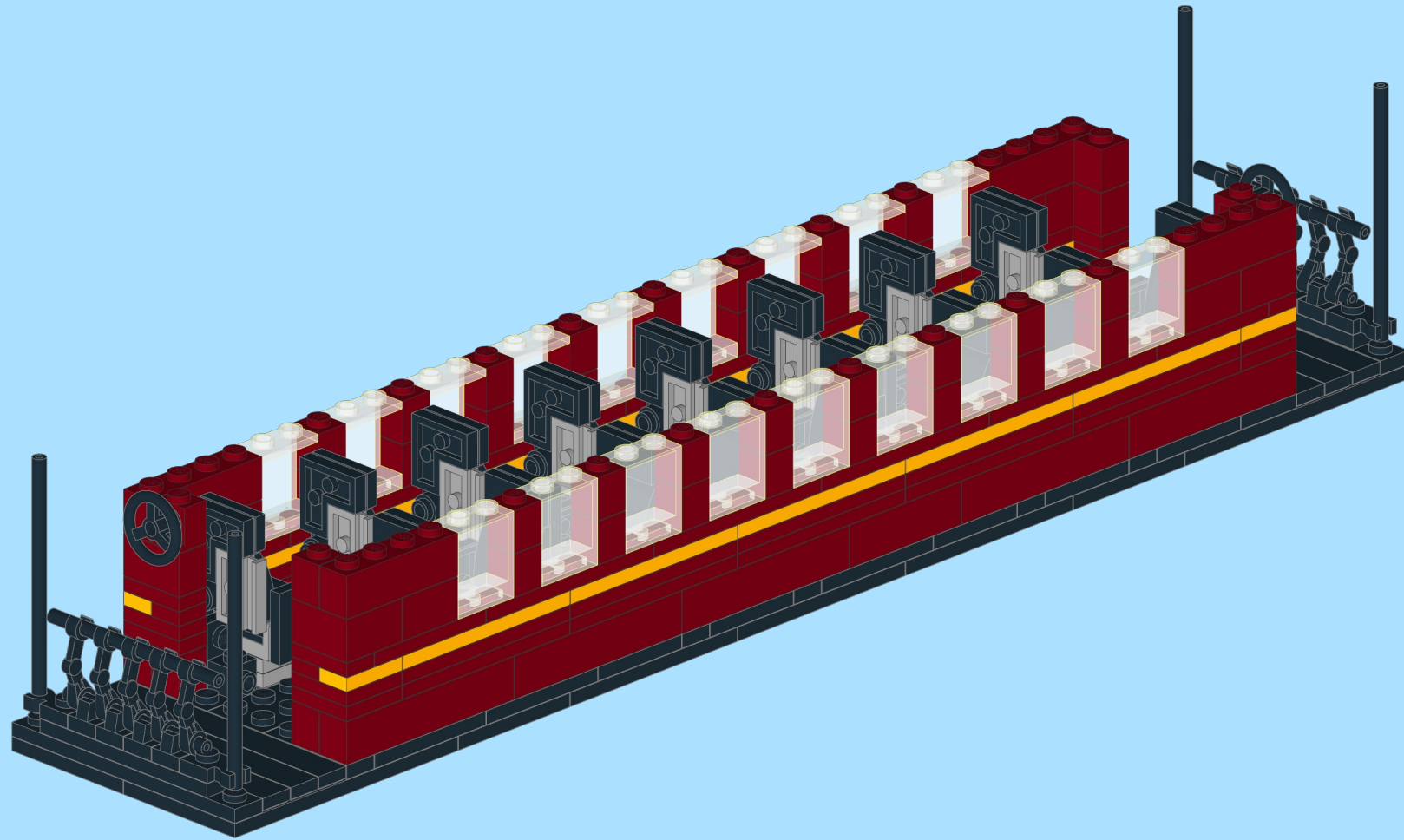
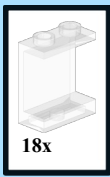

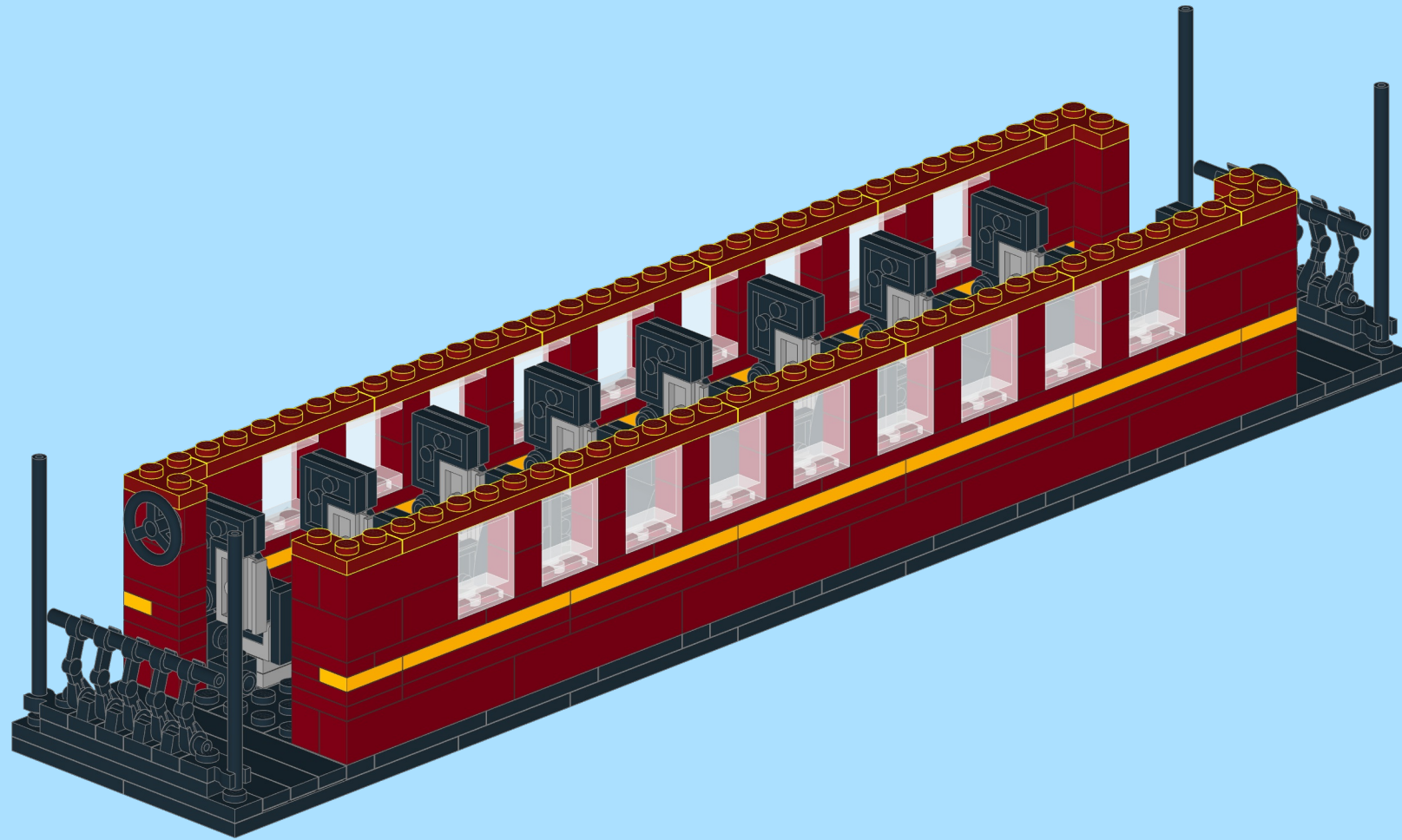
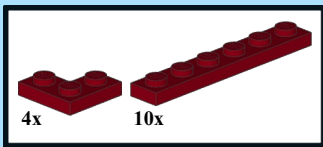

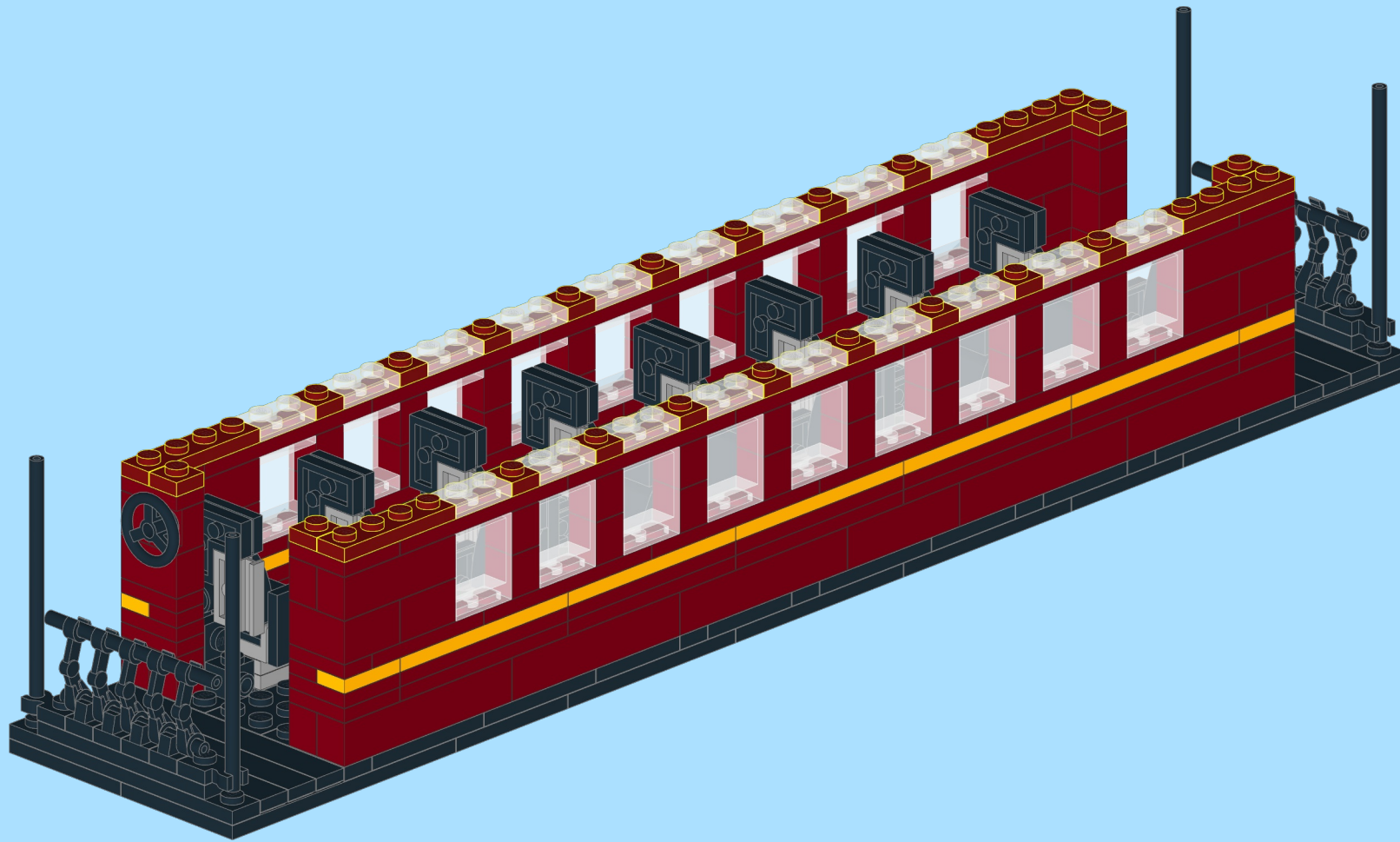
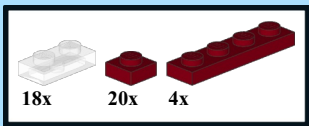

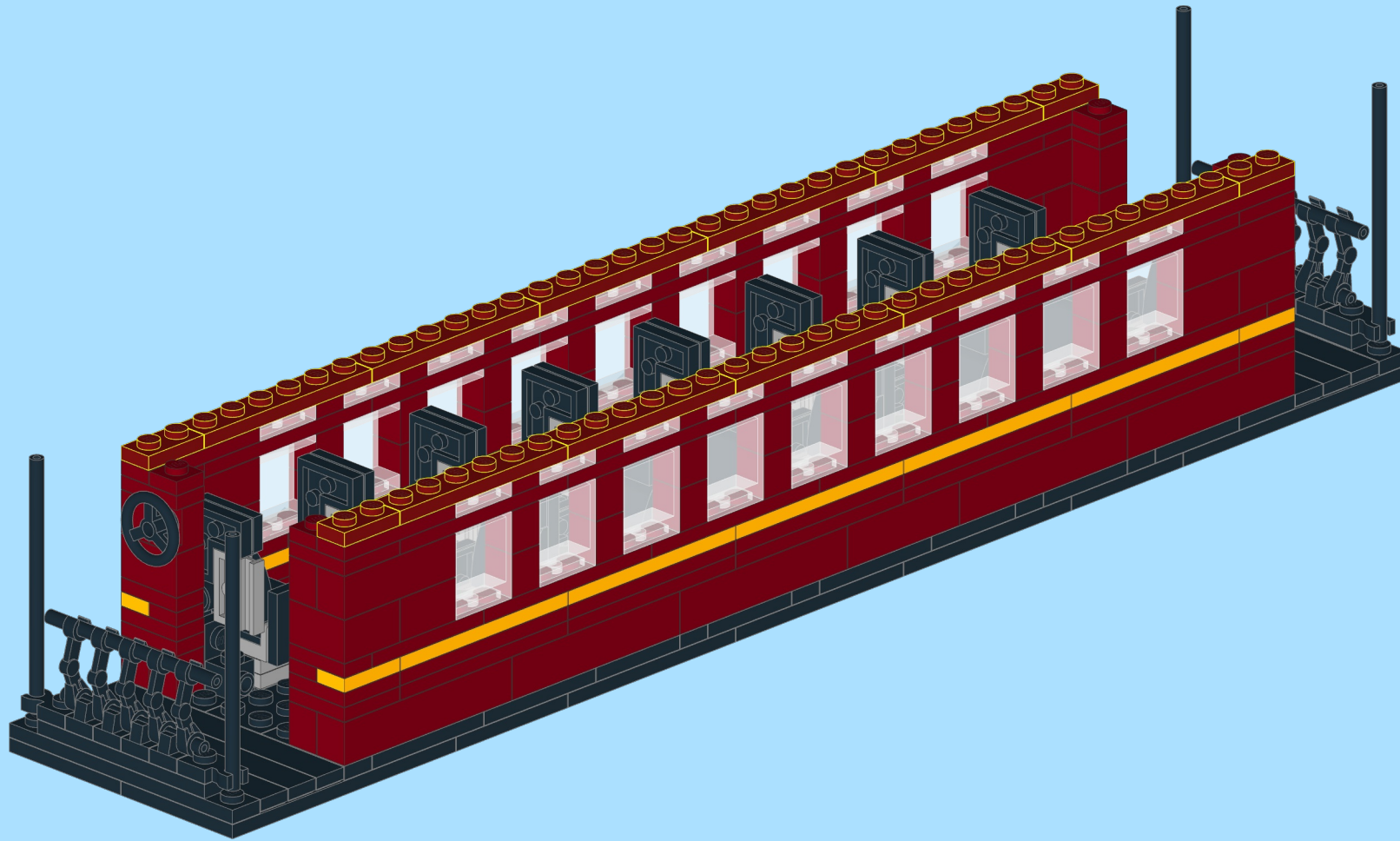
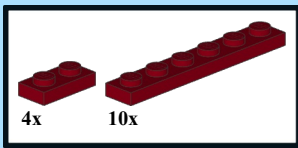

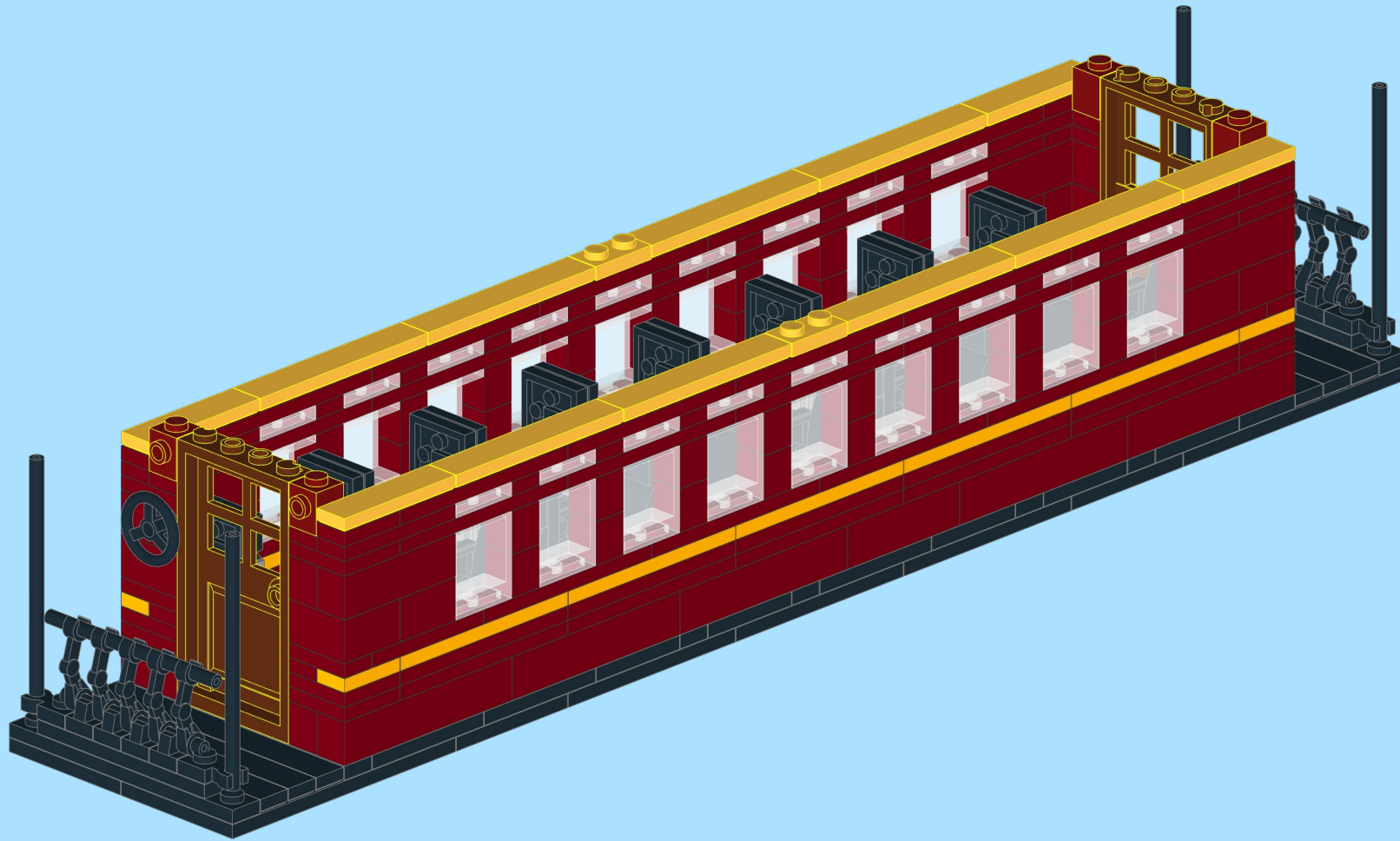
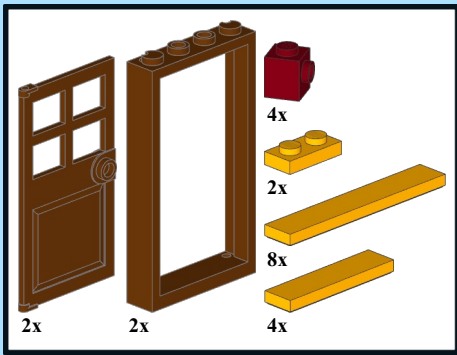

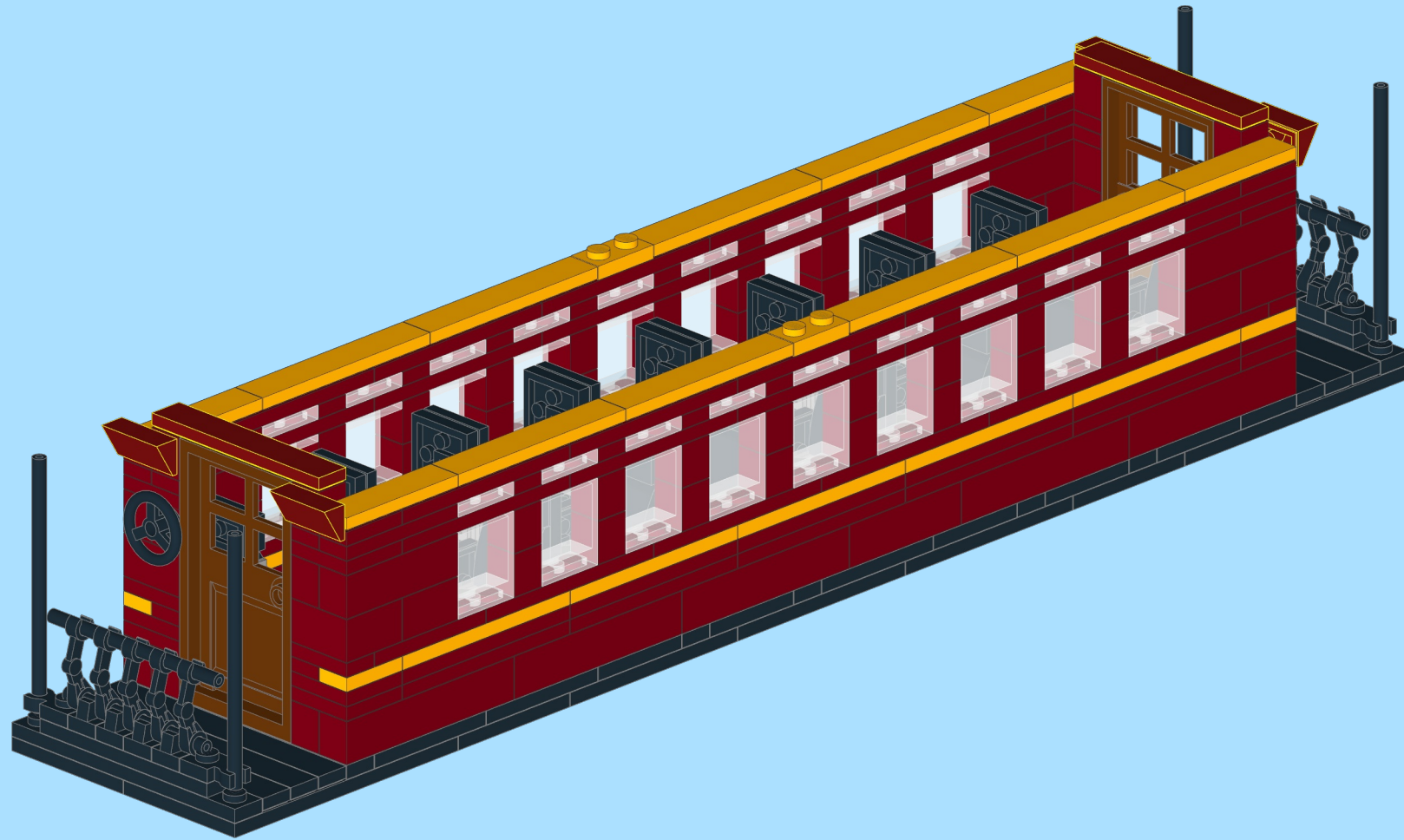
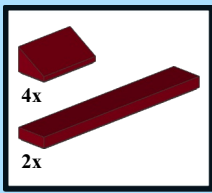

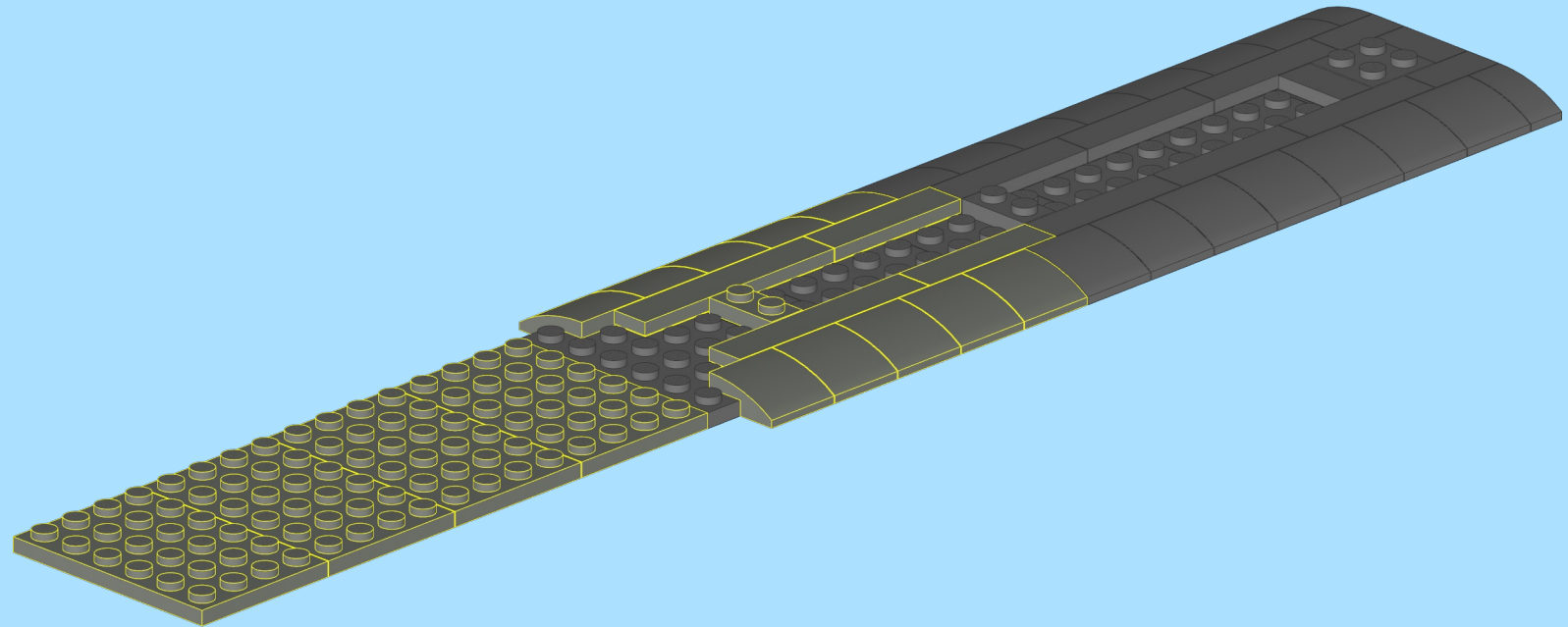
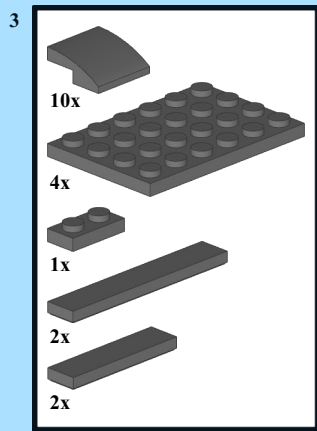
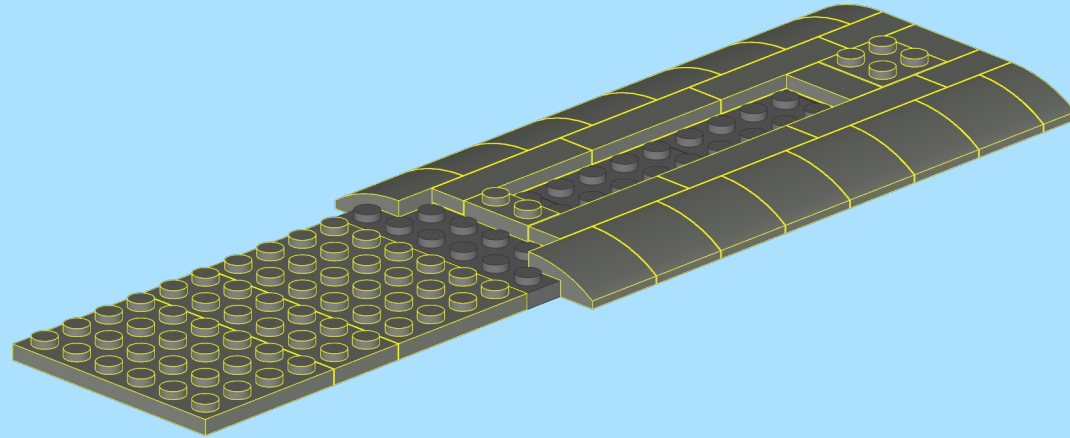
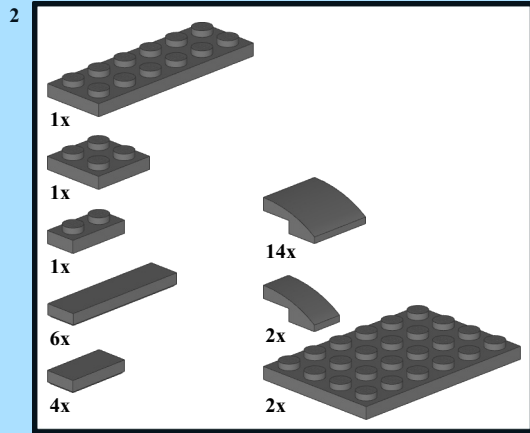
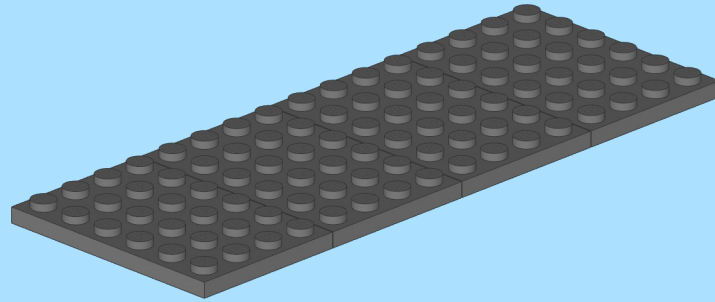
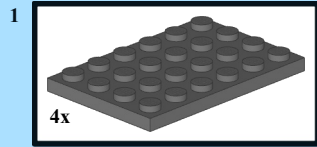

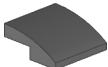
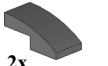
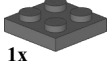





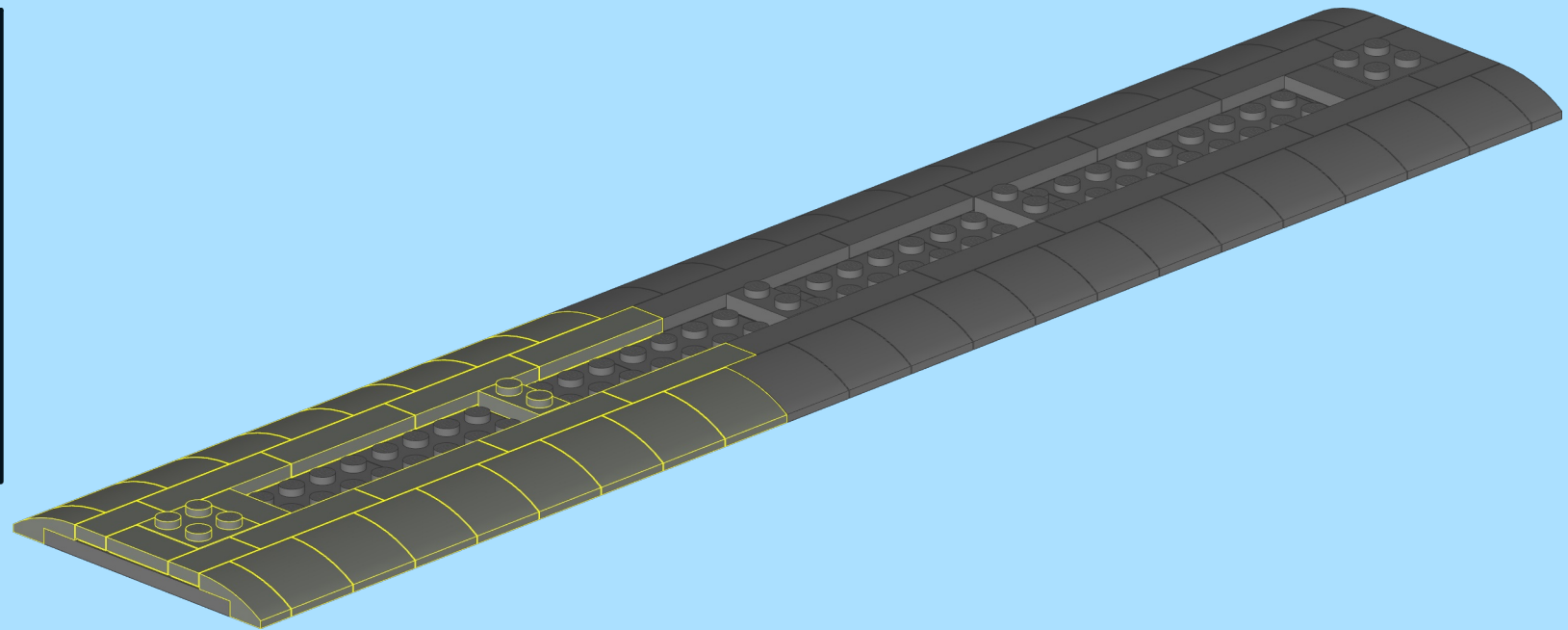







- 4
-  16x
 -  2x
 -  1x
 -  1x
 -  8x
 -  4x

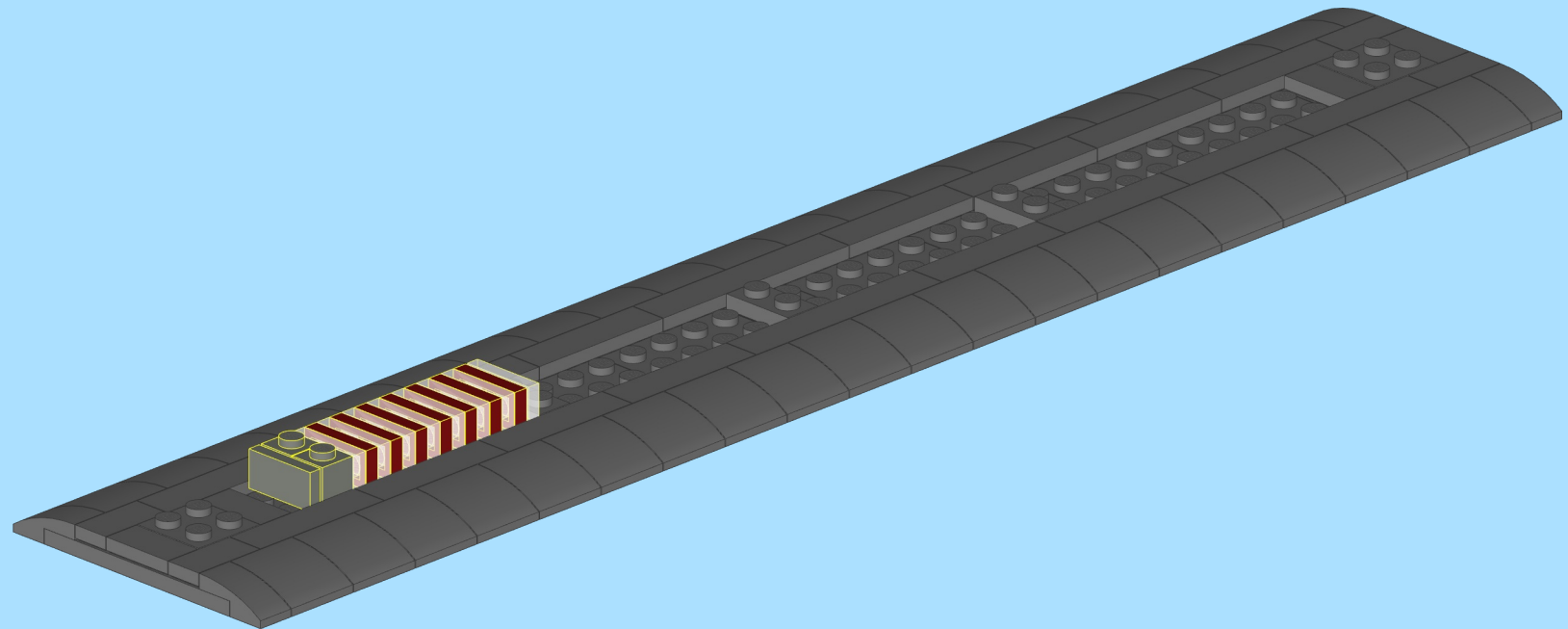



- 5
-  7x
 -  2x
 -  1x
 -  7x
 -  1x

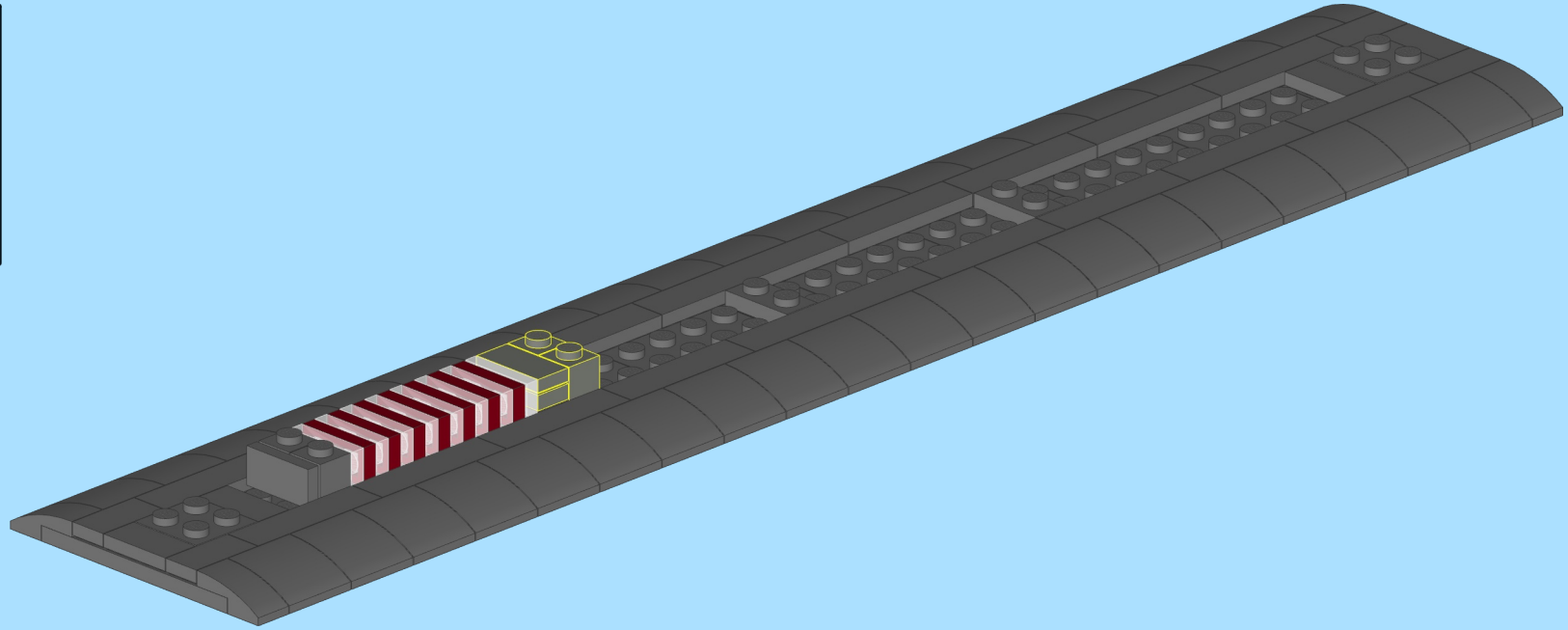

- 6
-  1x
 -  2x
 -  1x



- 7
-  7x
 -  7x
 -  1x

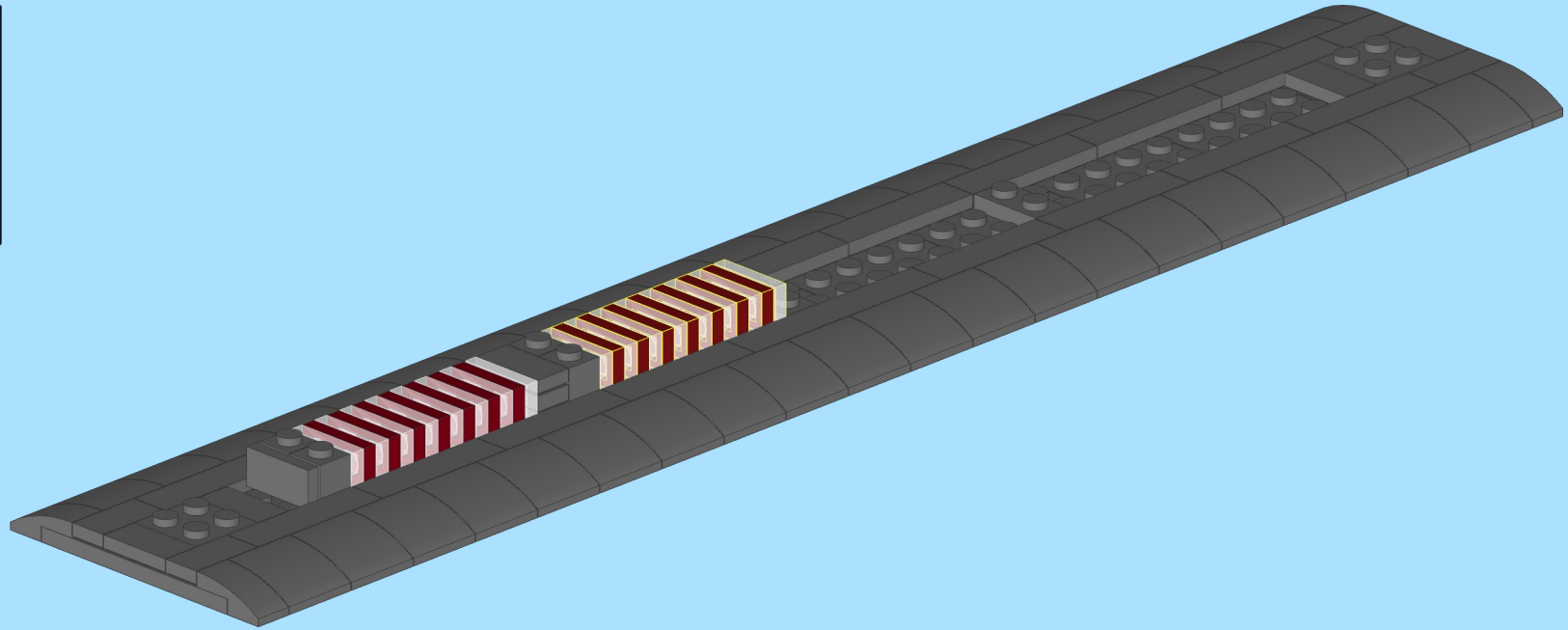

- 8
- 1x
 - 2x
 - 1x

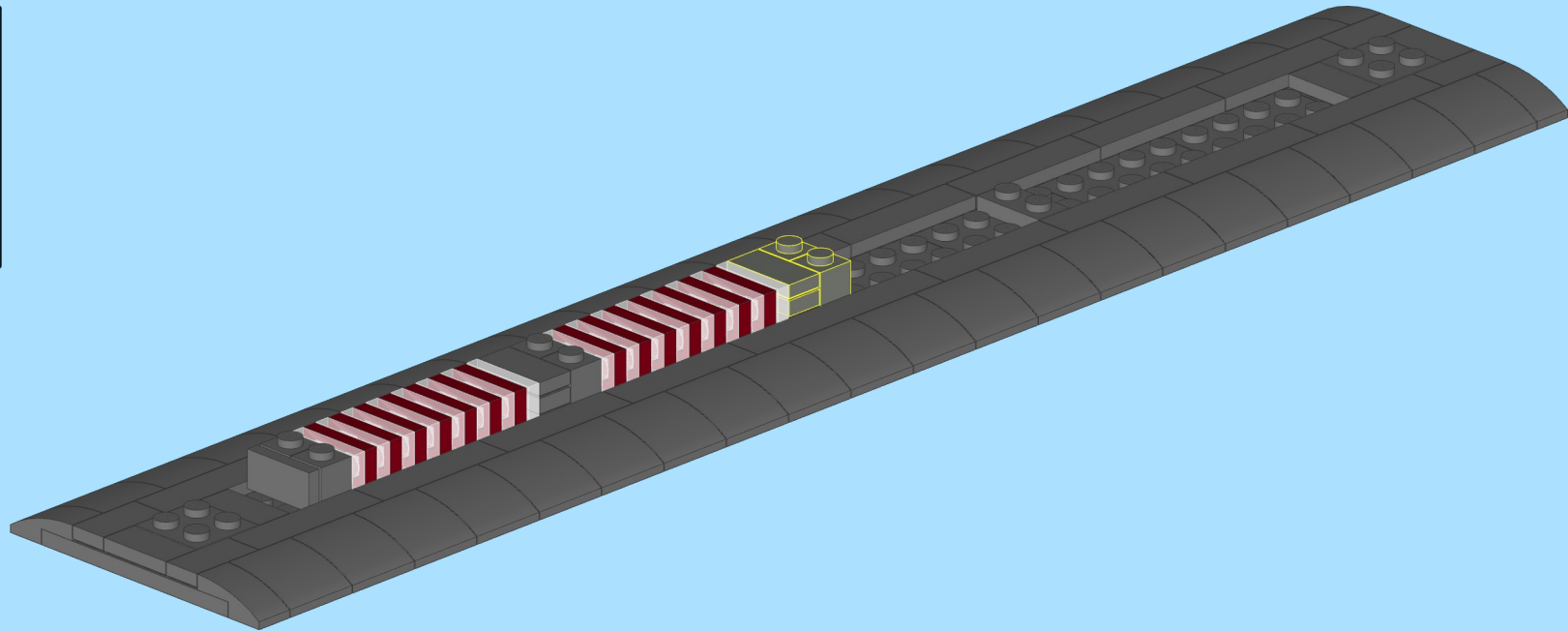

- 9
- 7x
 - 7x
 - 1x

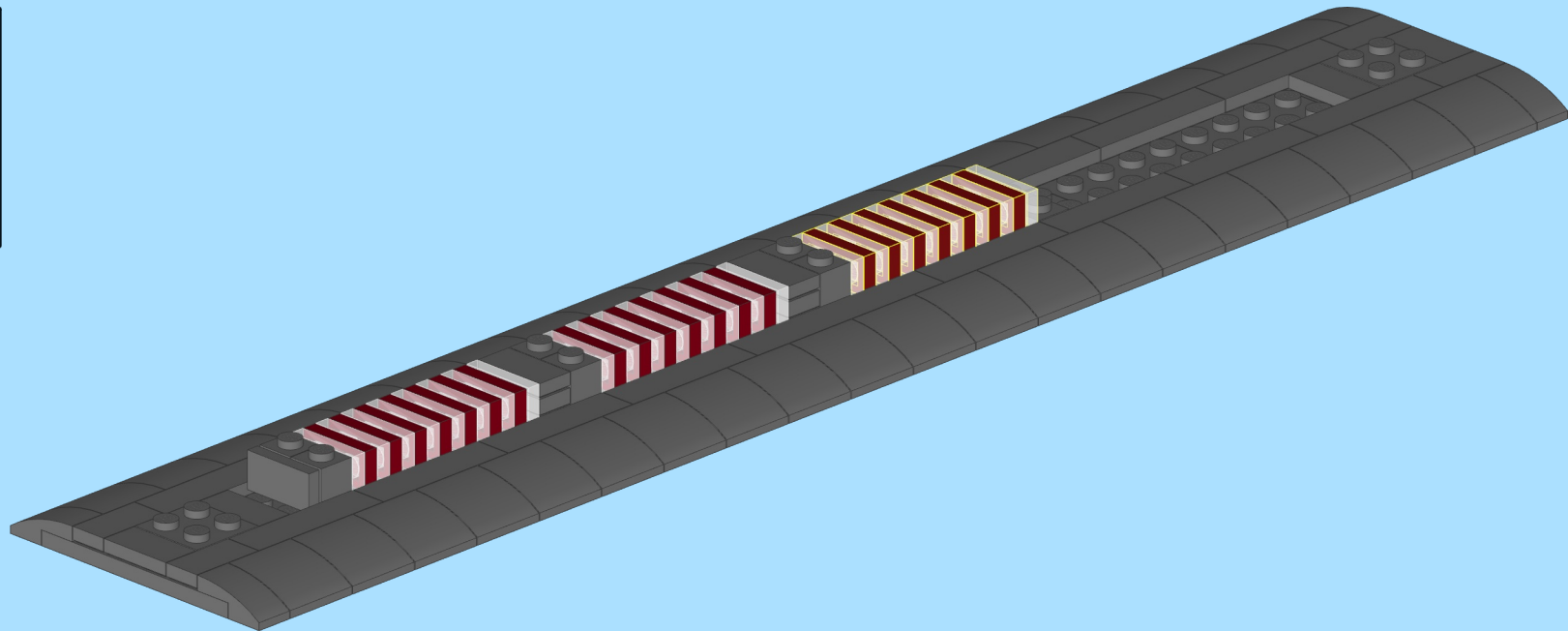

10

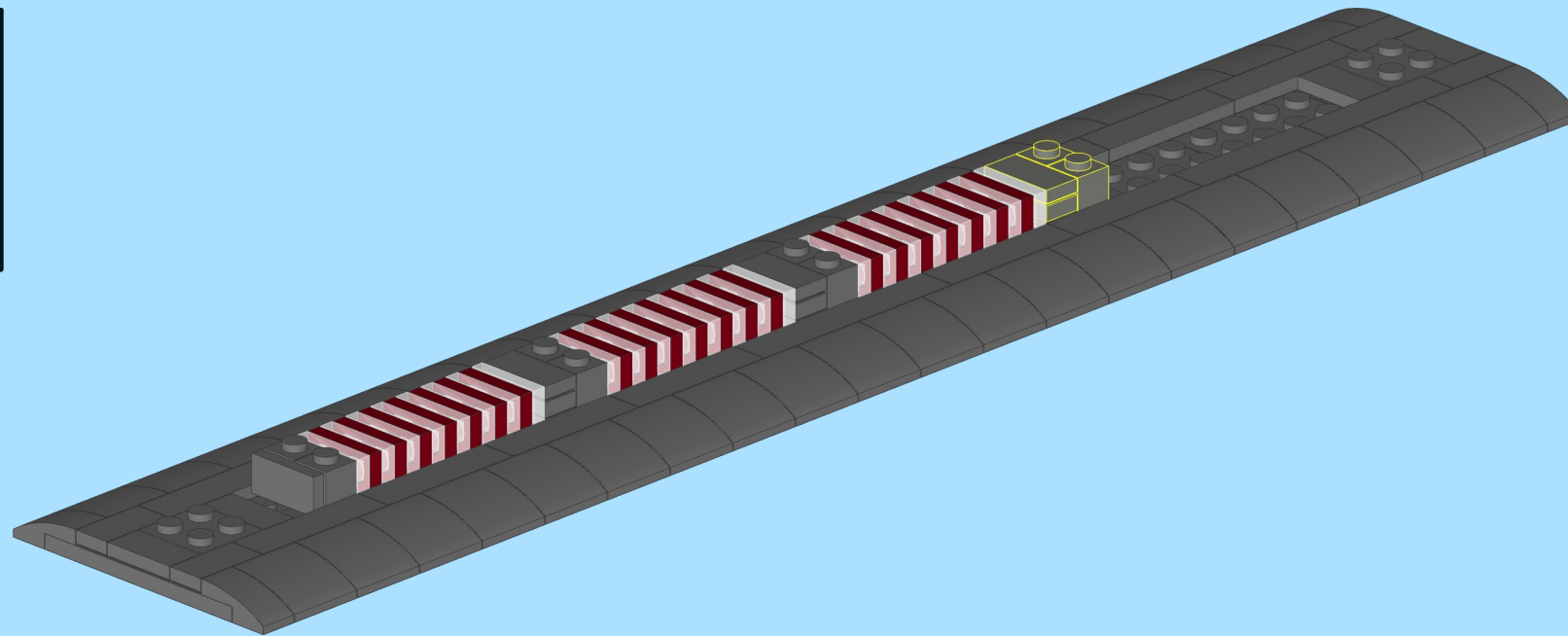
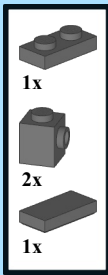

11

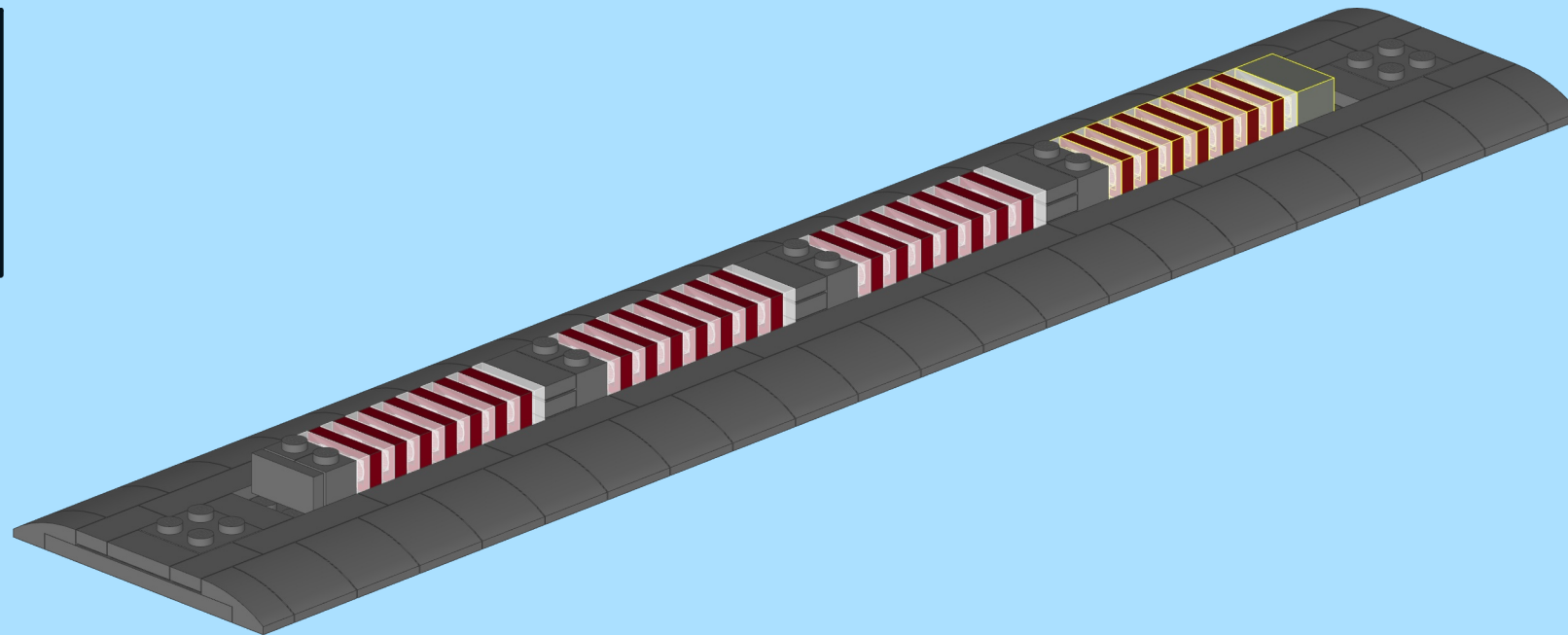
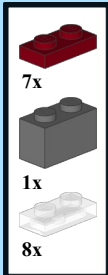

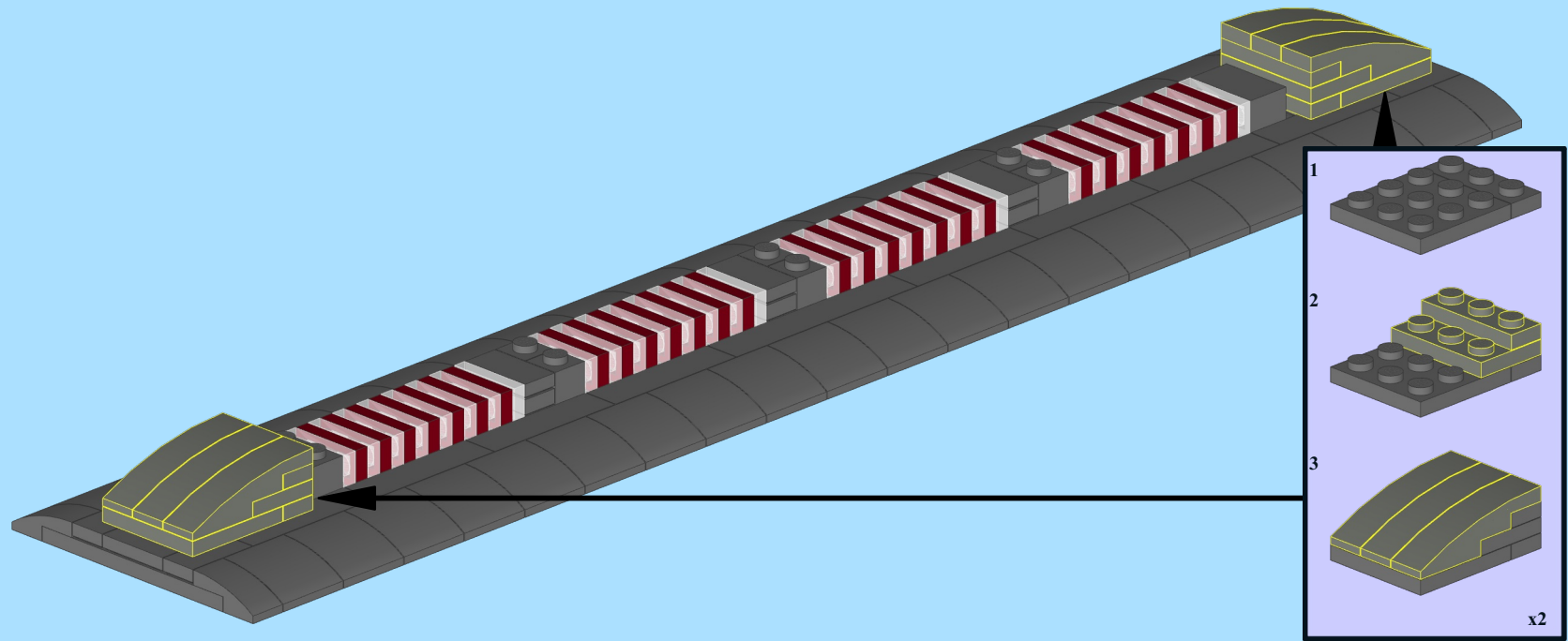
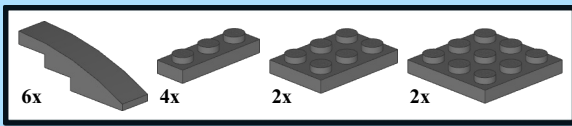

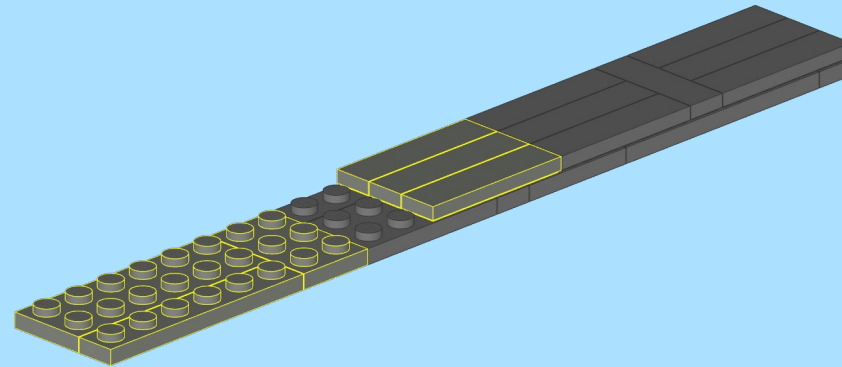
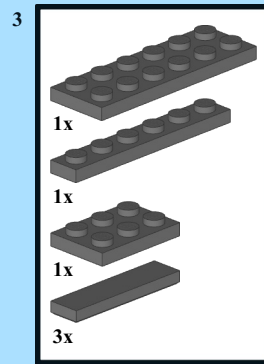
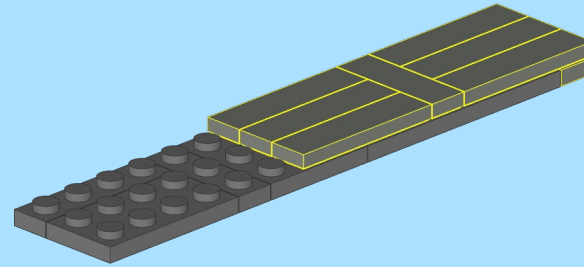
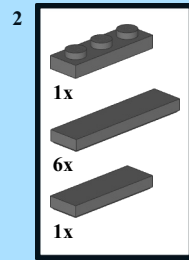
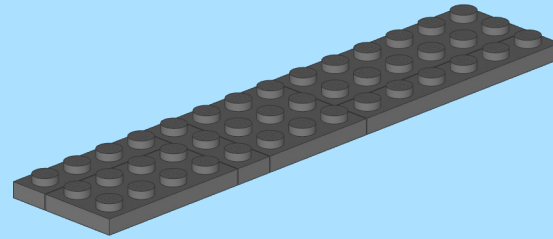
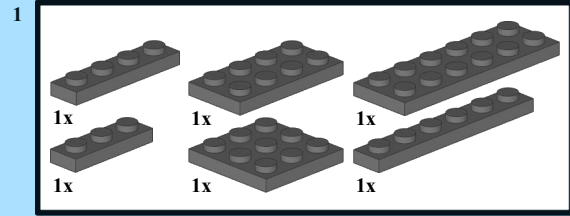

- 4
- 1x
 - 2x
 - 1x
 - 2x
 - 3x
 - 2x

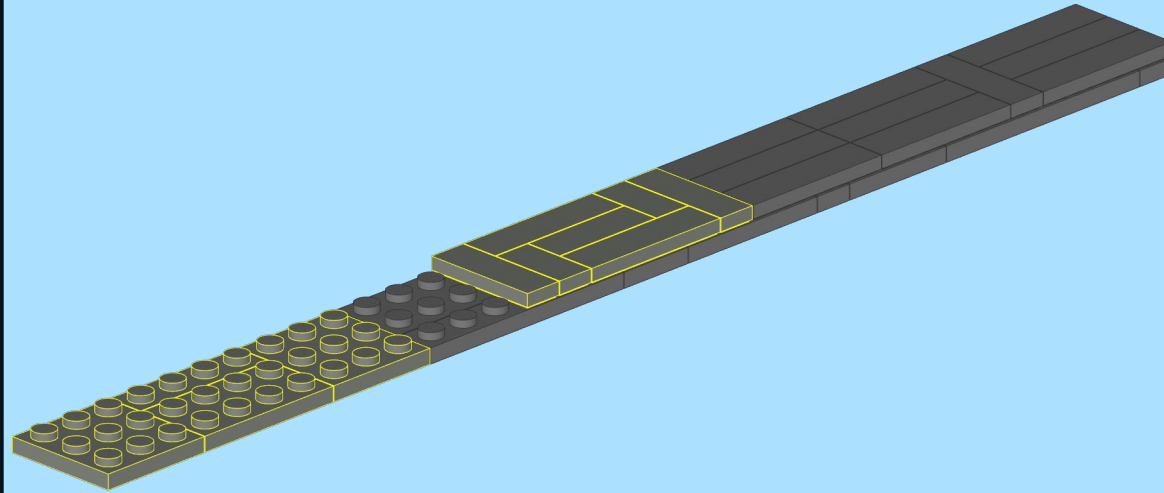

- 5
- 9x
 - 1x

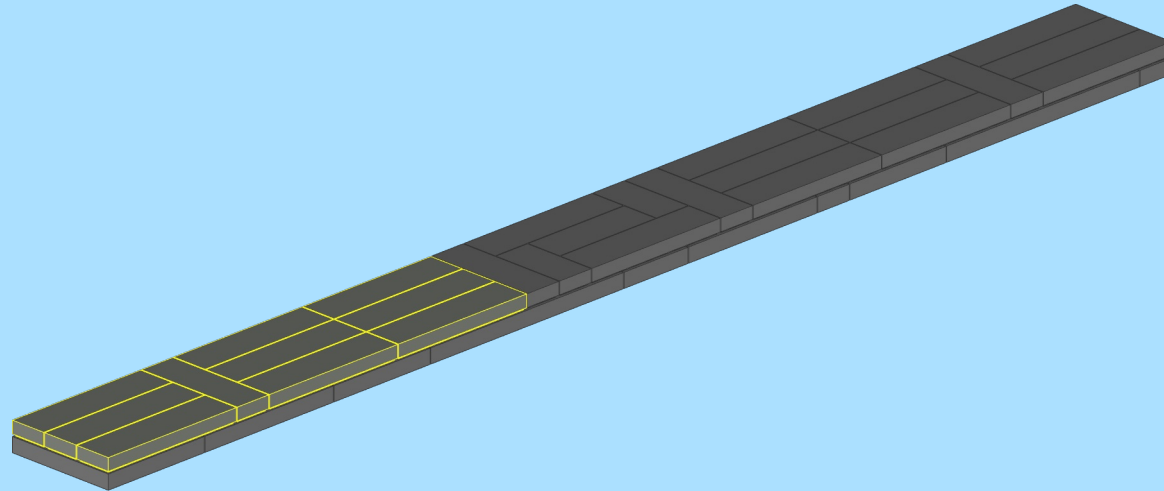

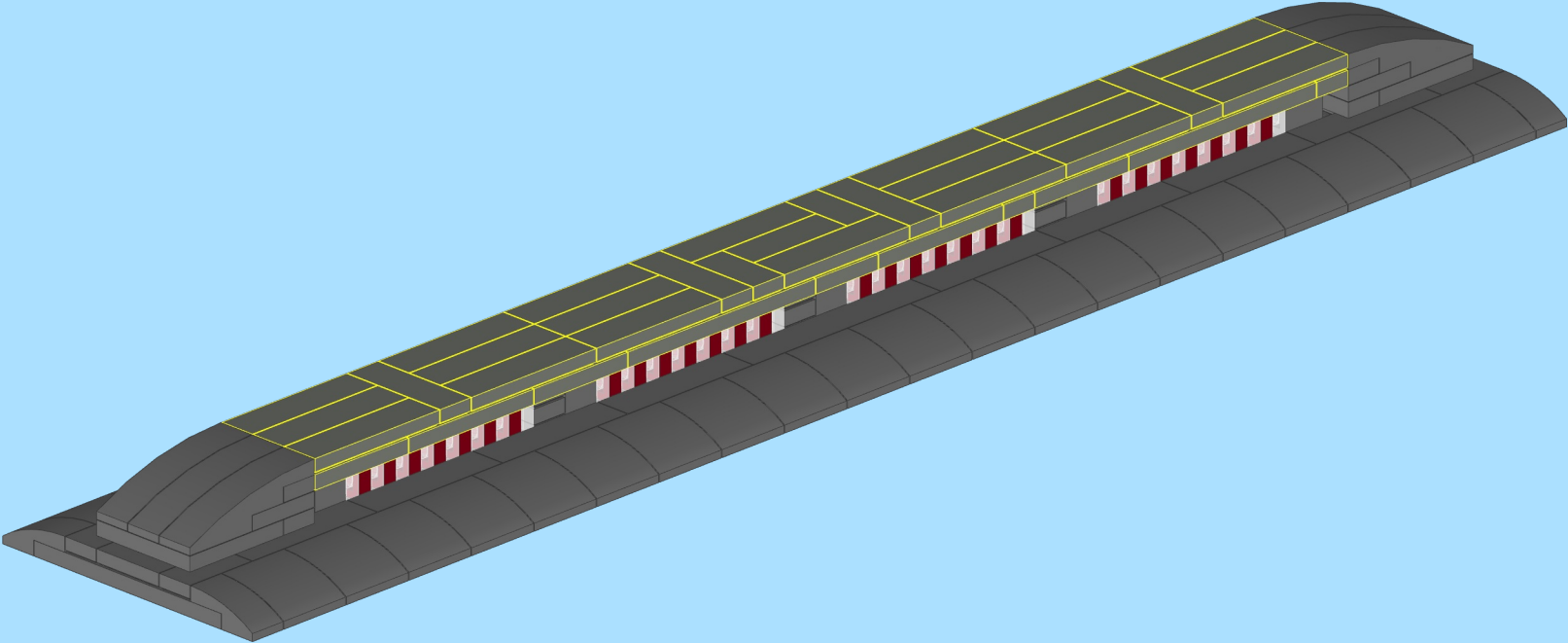

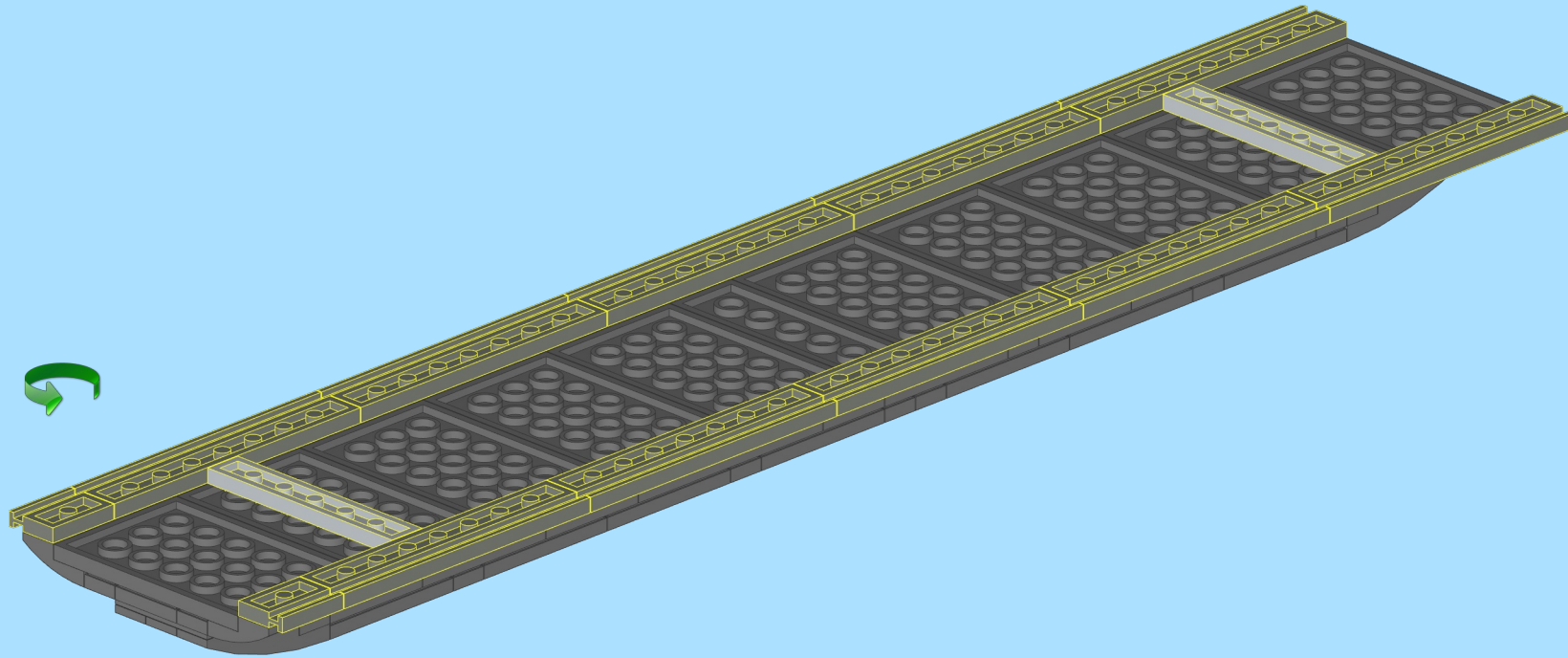
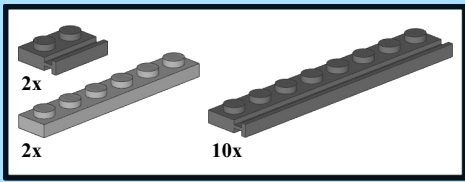

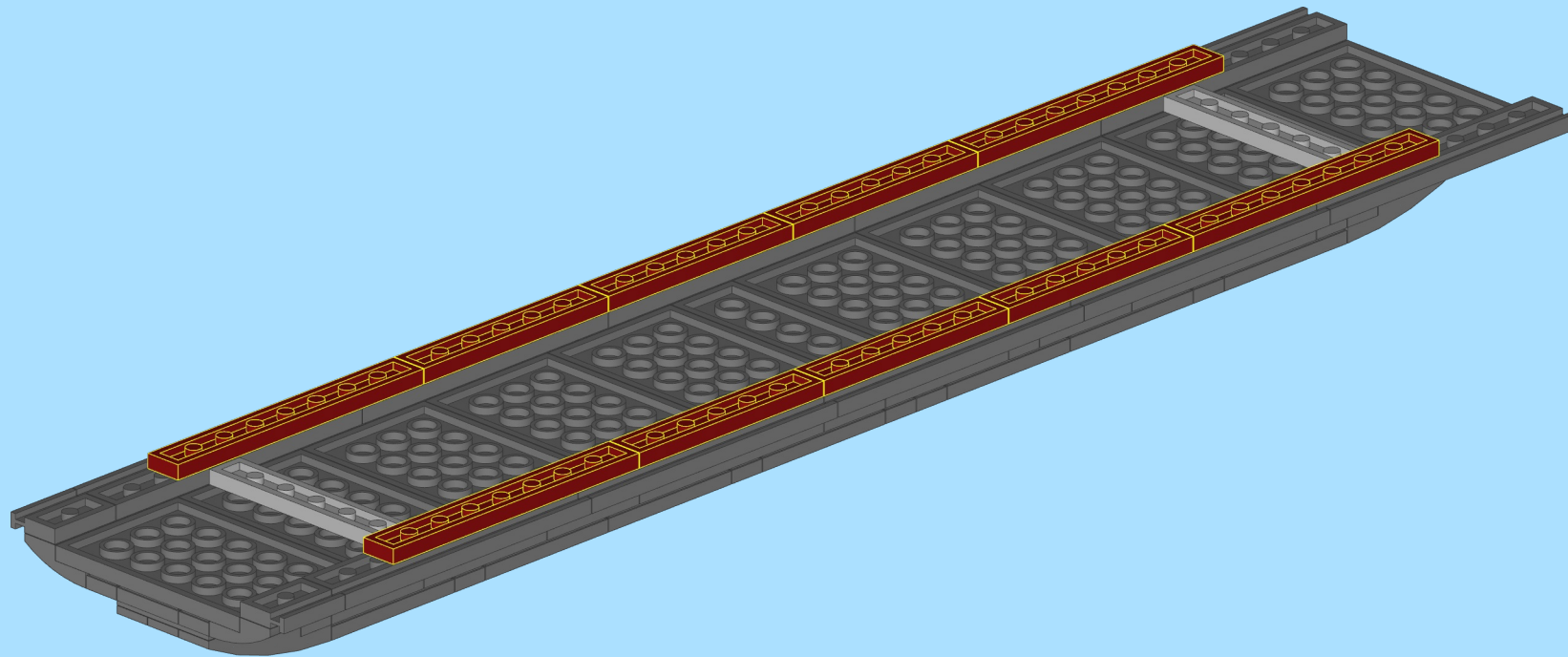
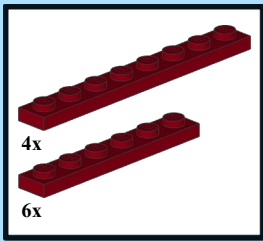

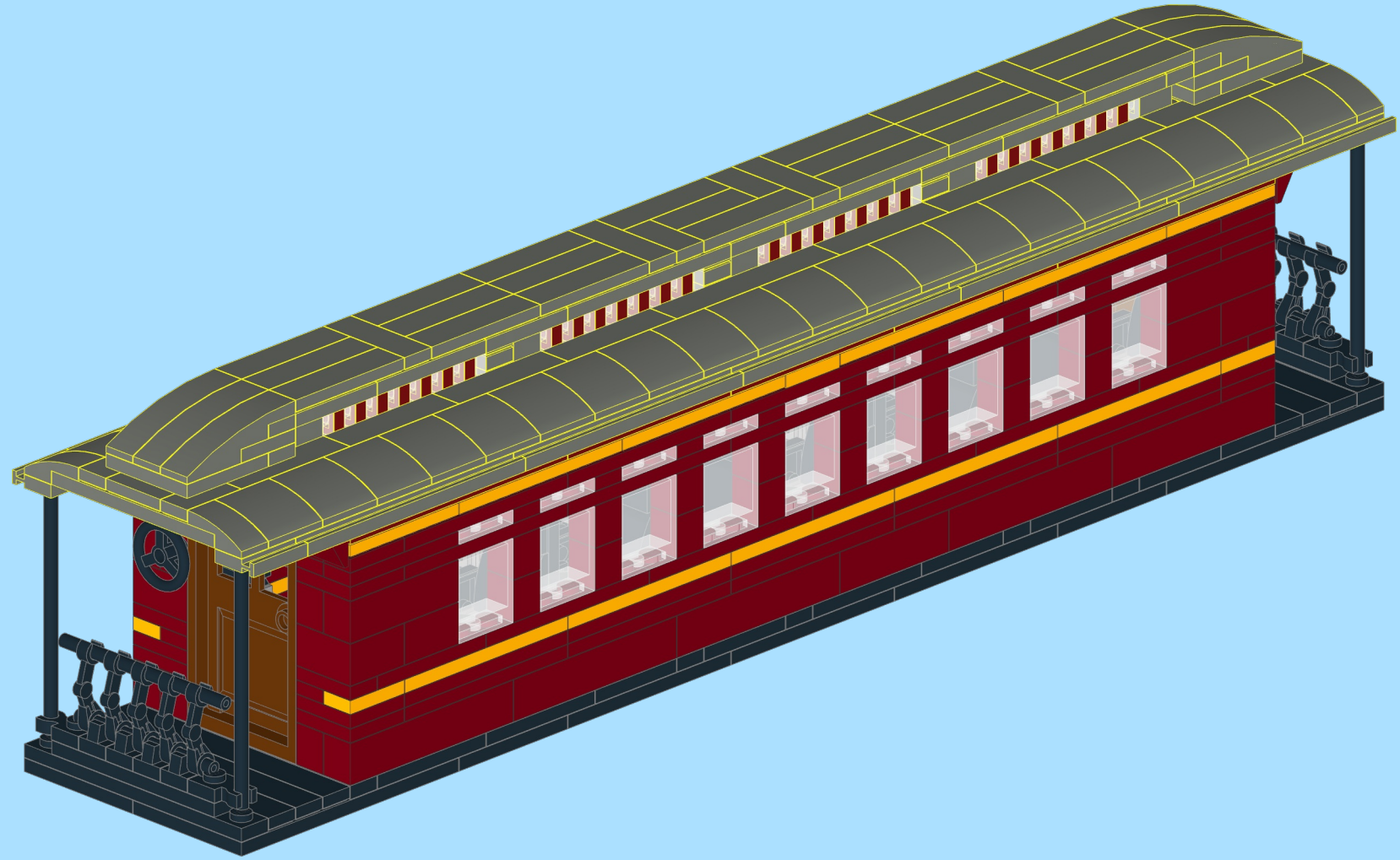

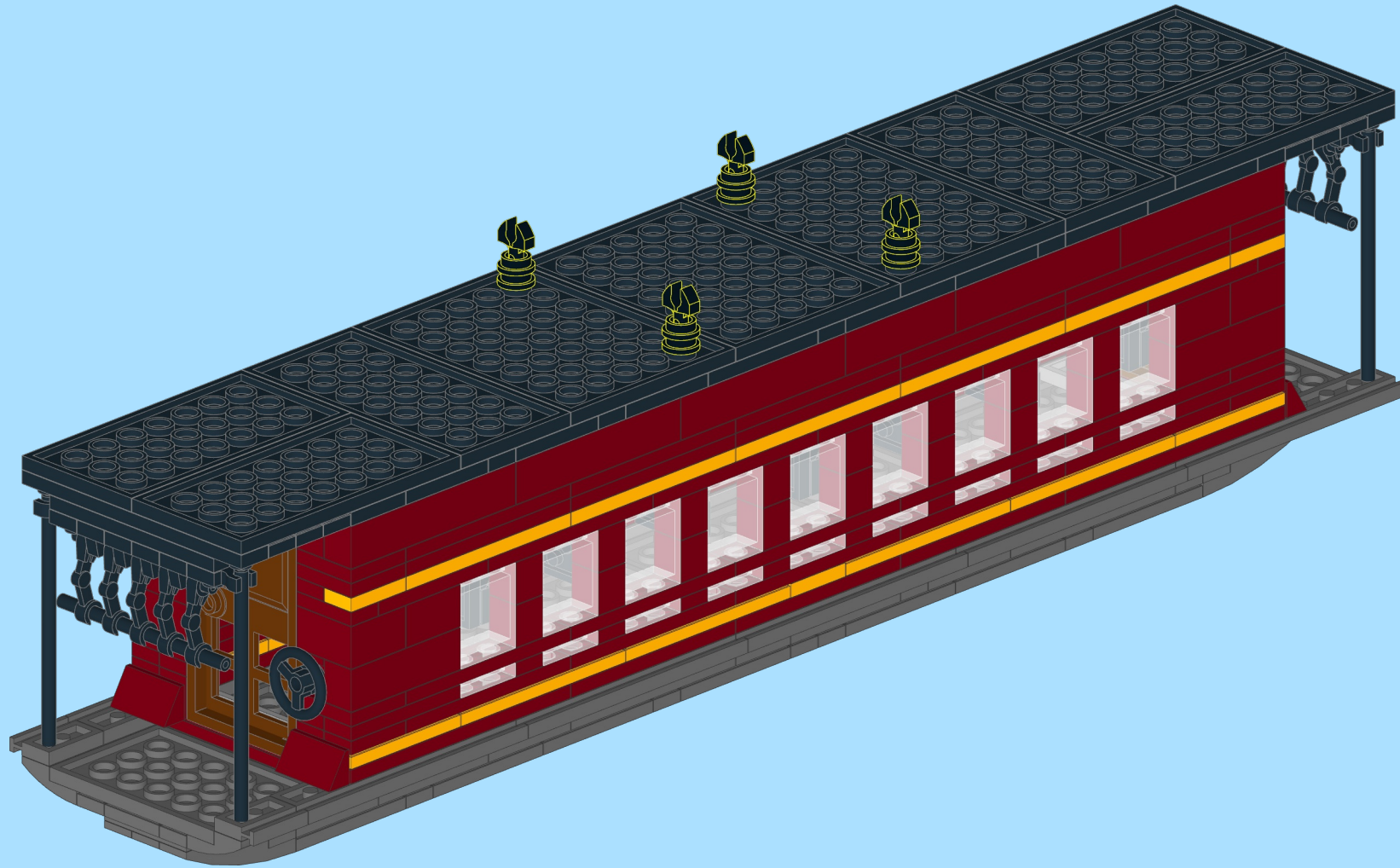

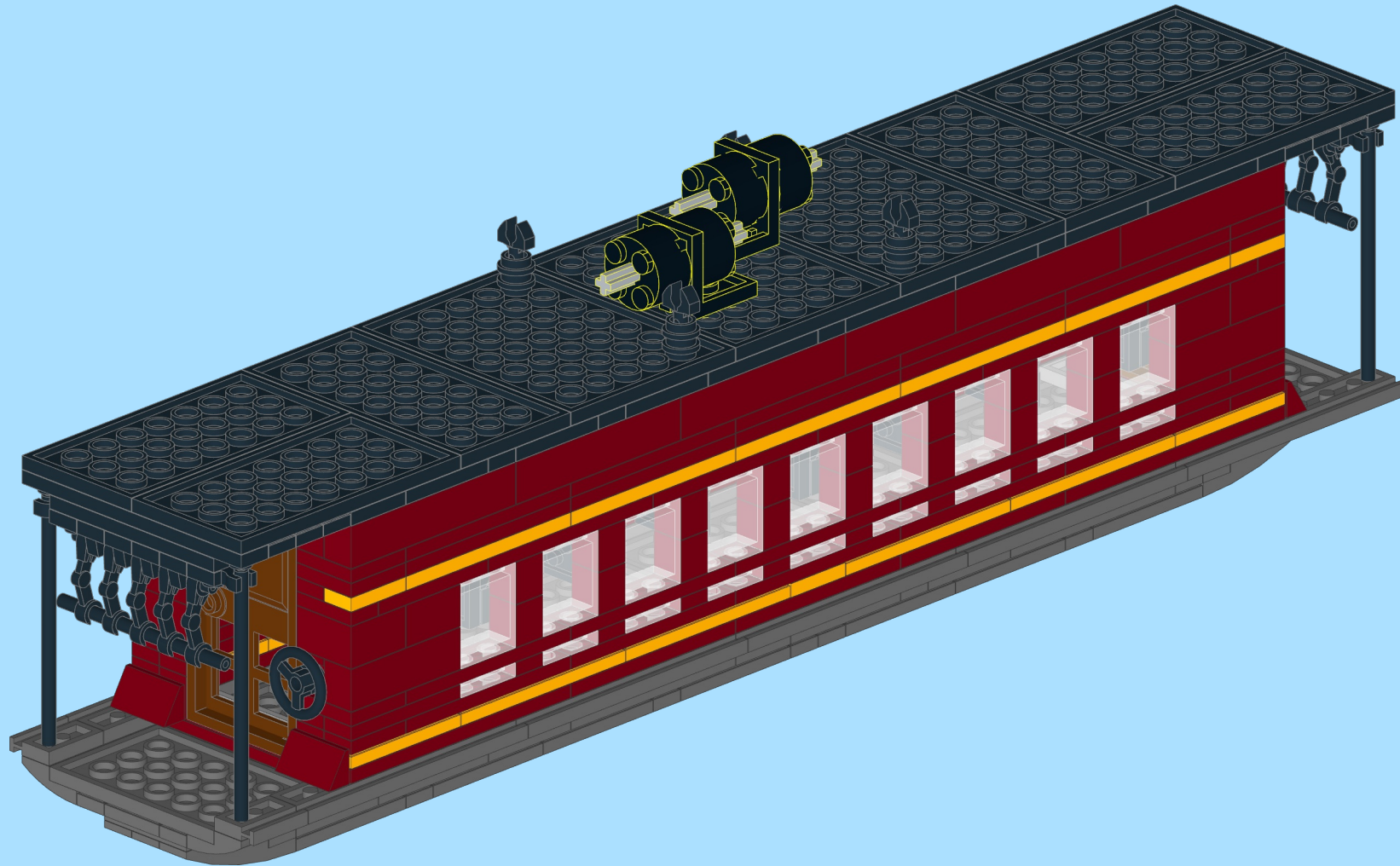
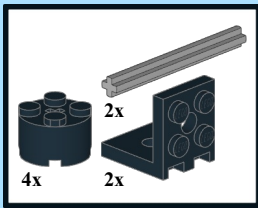

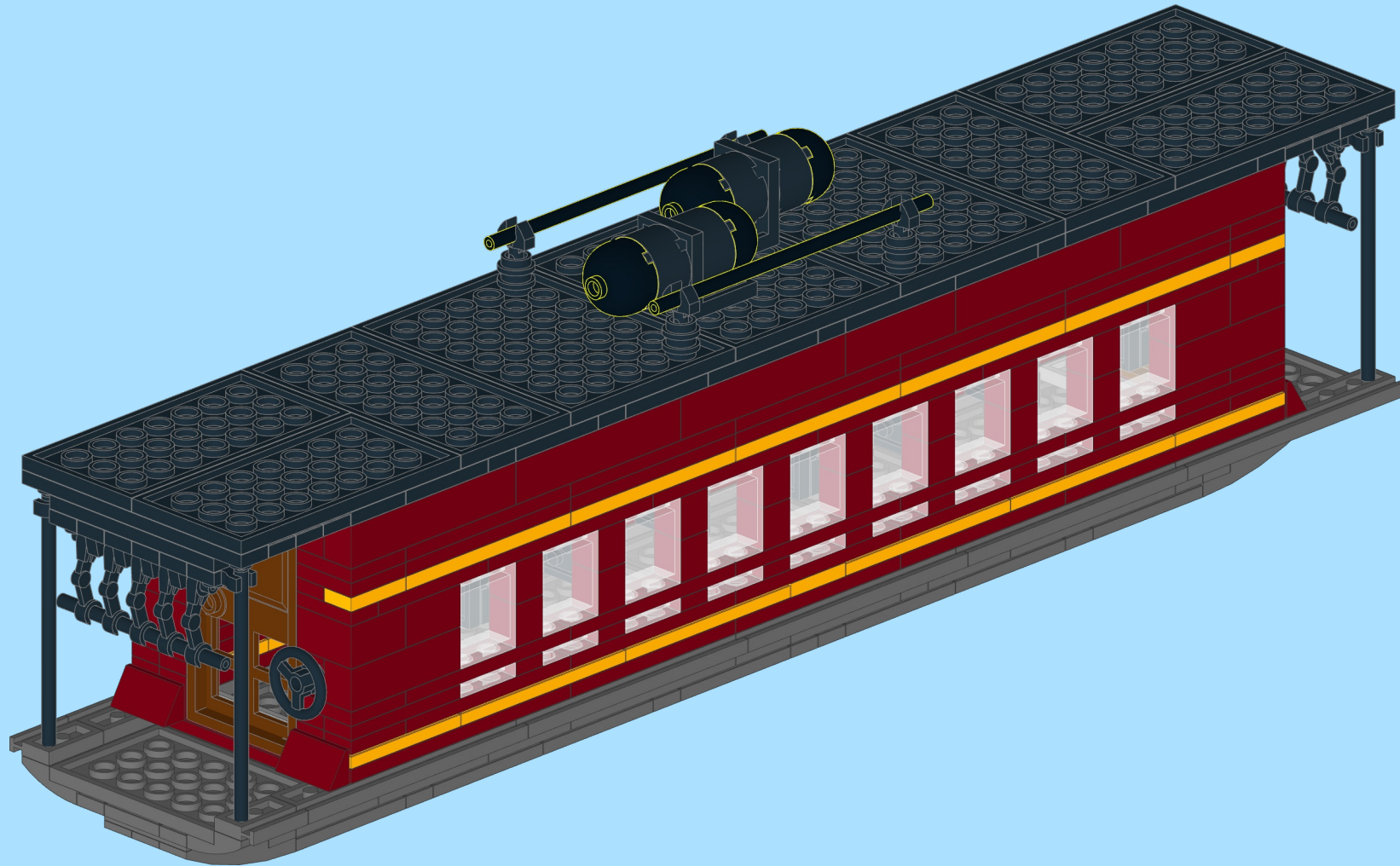

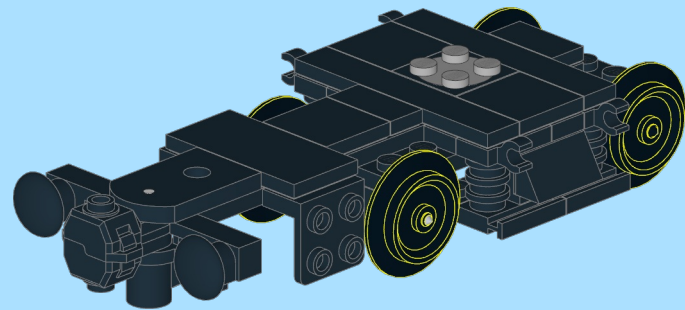
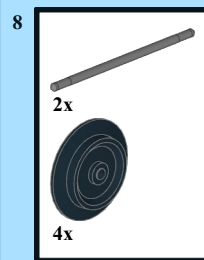
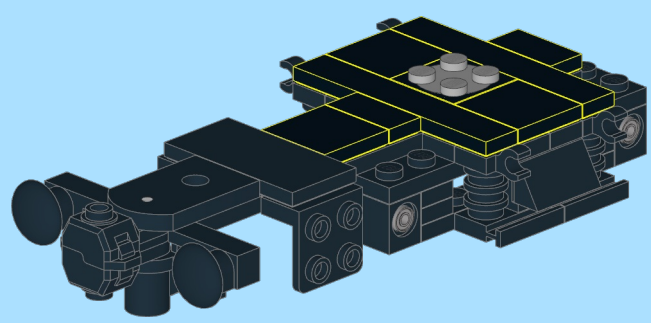
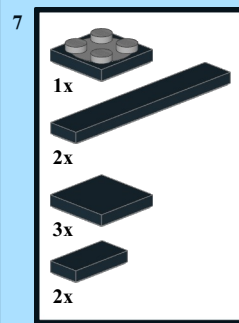
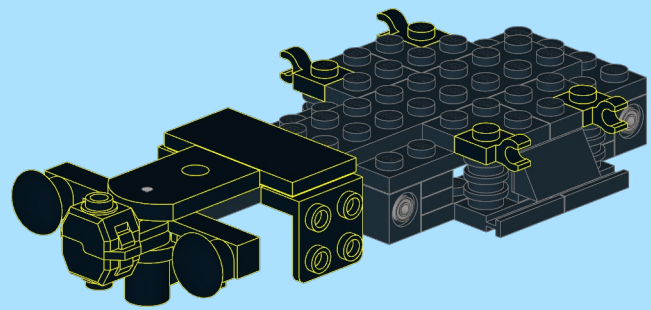
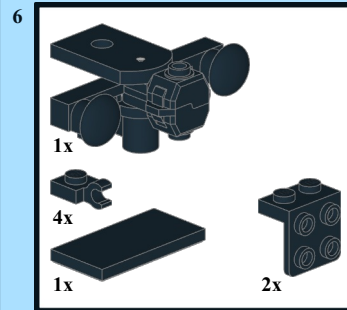
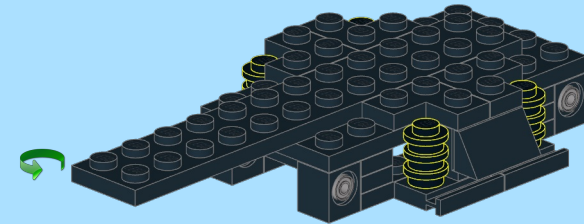
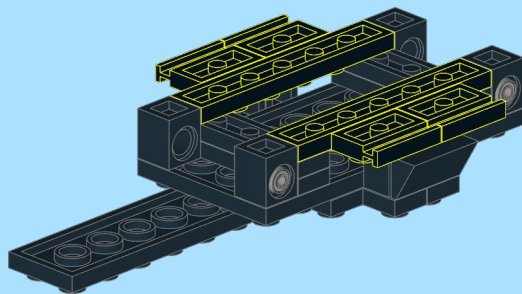
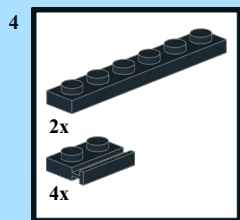
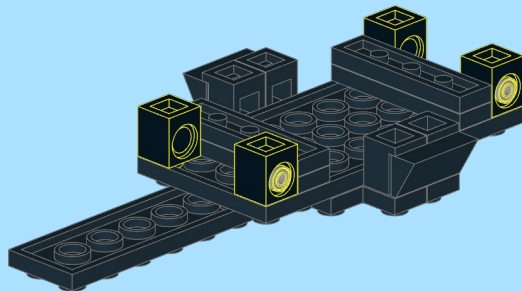
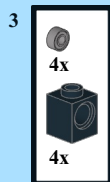
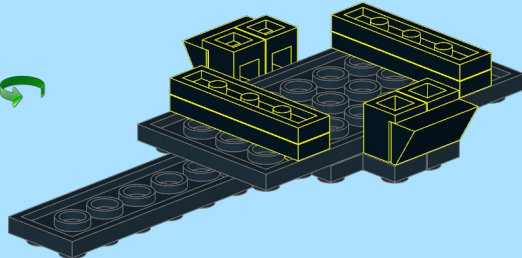
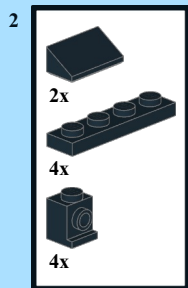
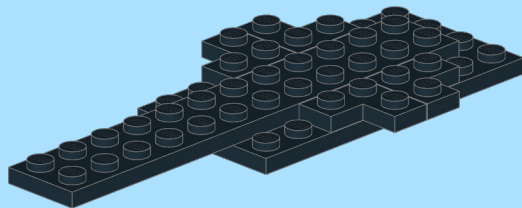
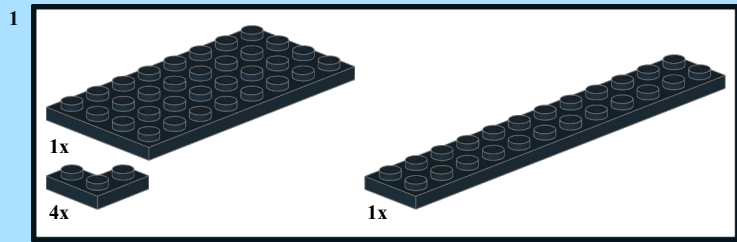

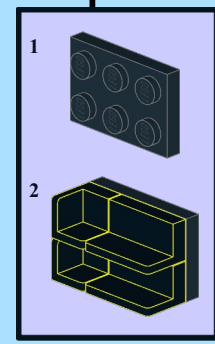
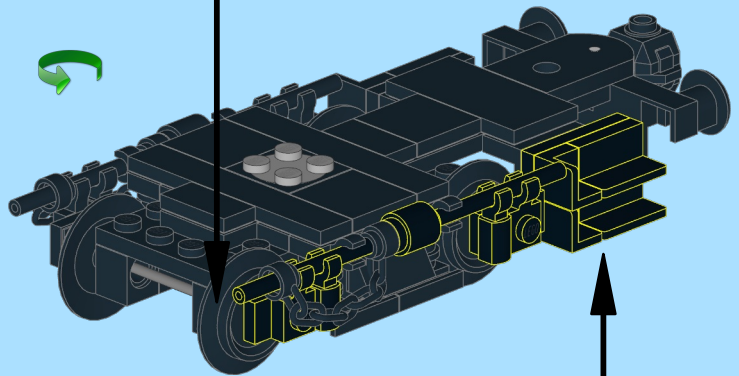
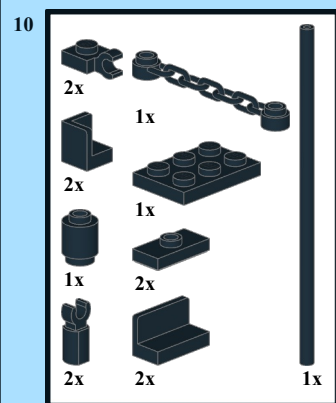
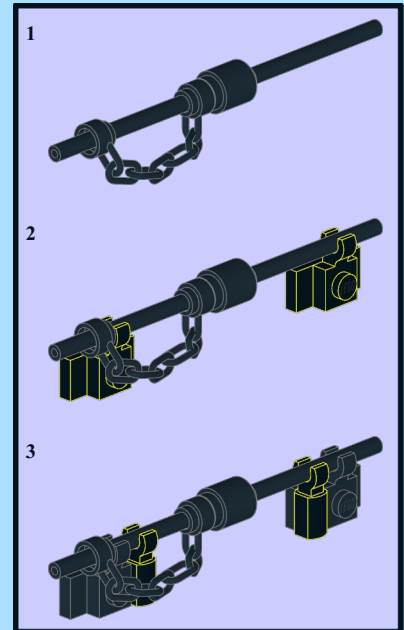
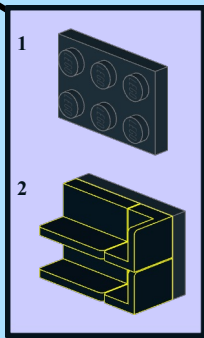
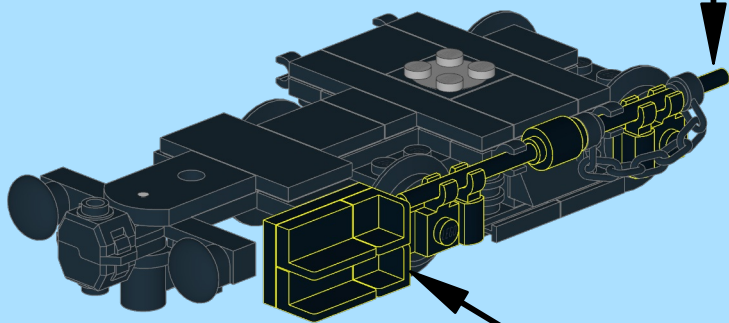
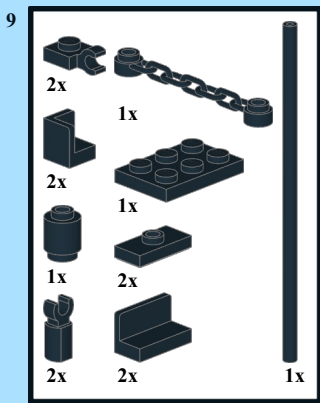
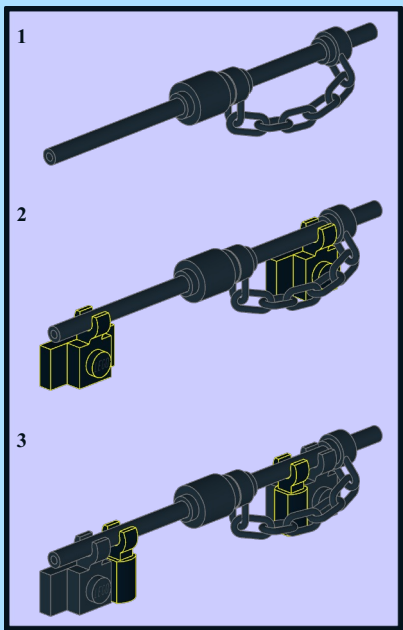

x2

